

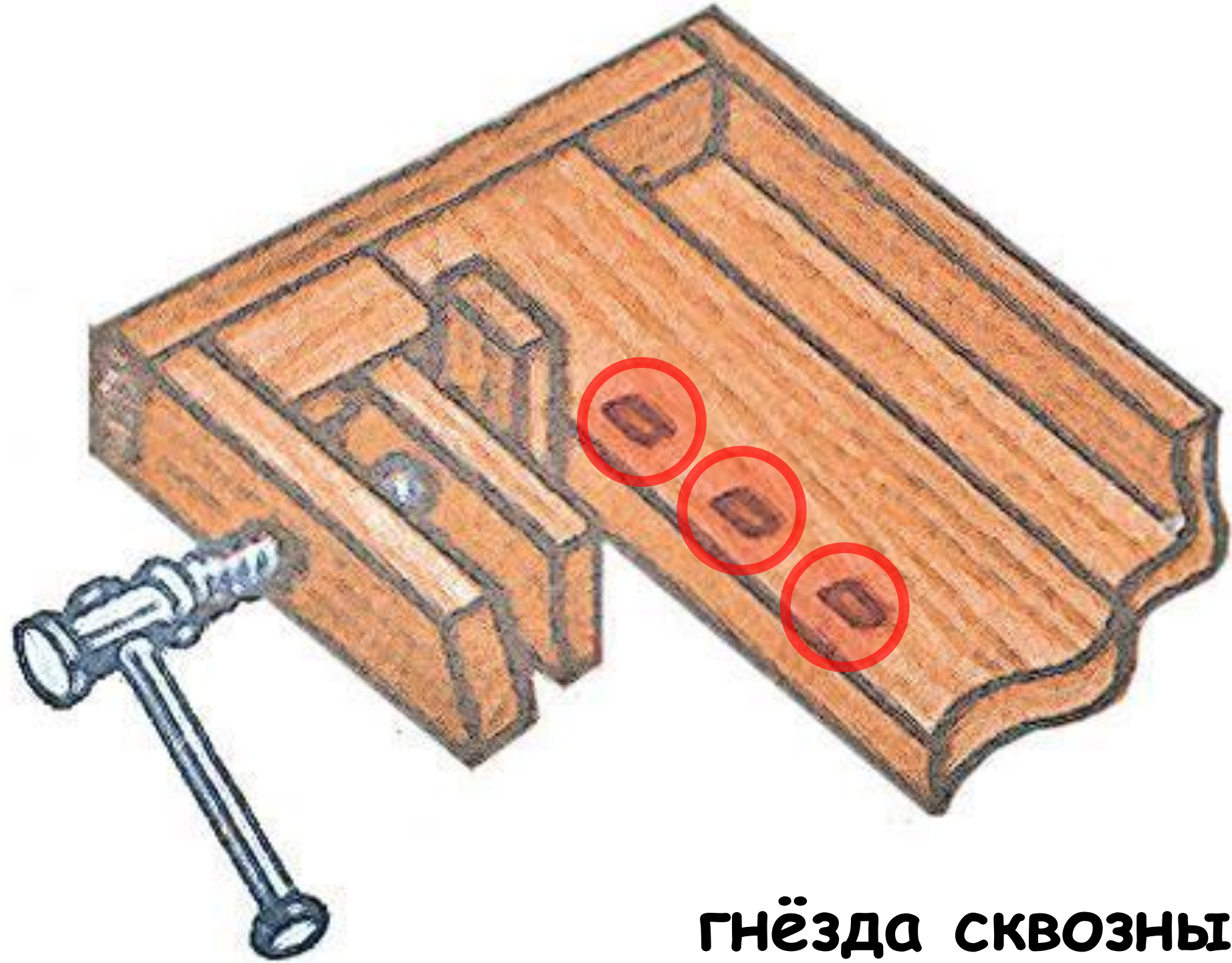

БЕРСТАК



ПЕРЕДНИЕ ТИСКИ



ГНЁЗДА СКВОЗНЫЕ

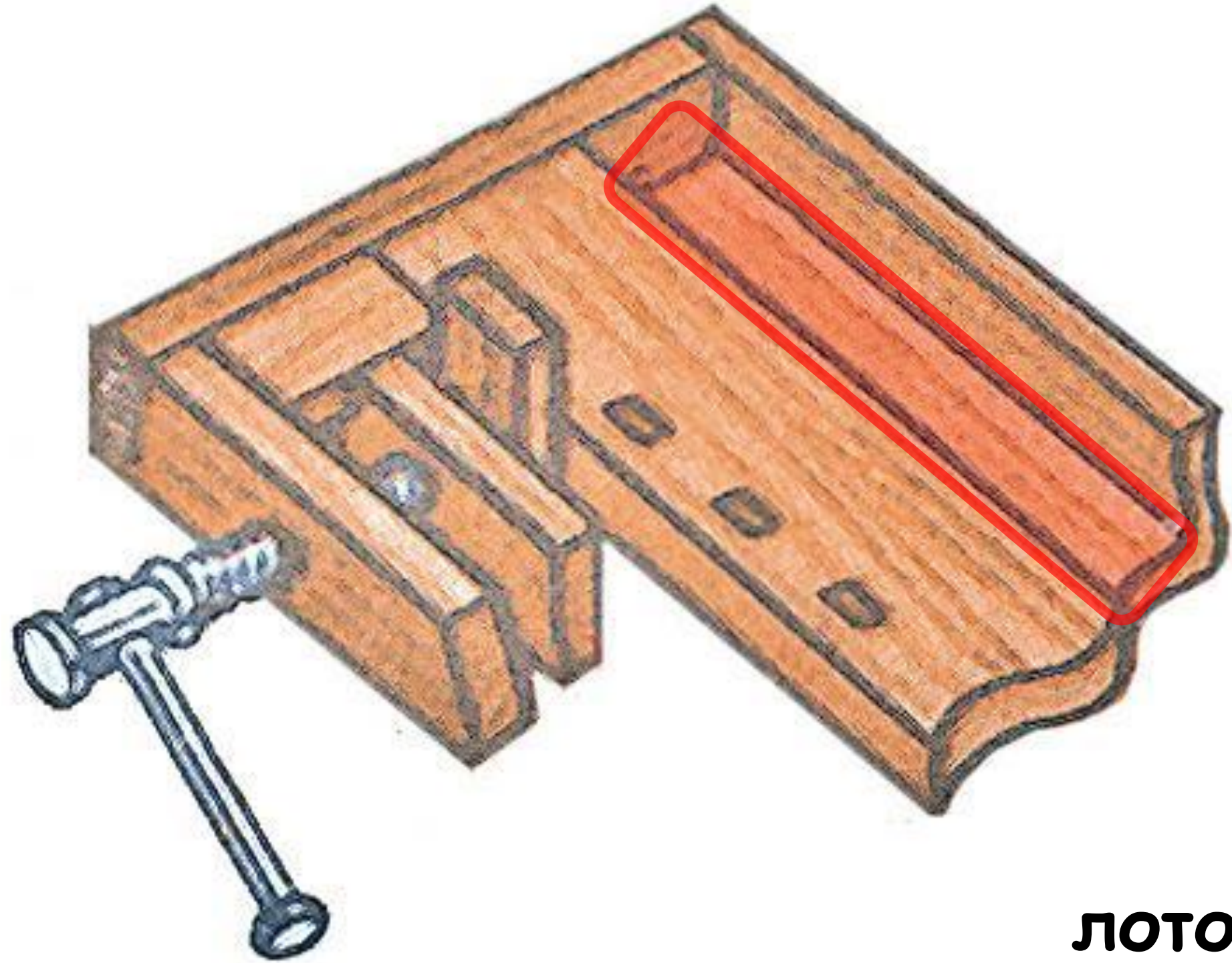

ЛОТОК



Верстачная доска



Подкладочная доска

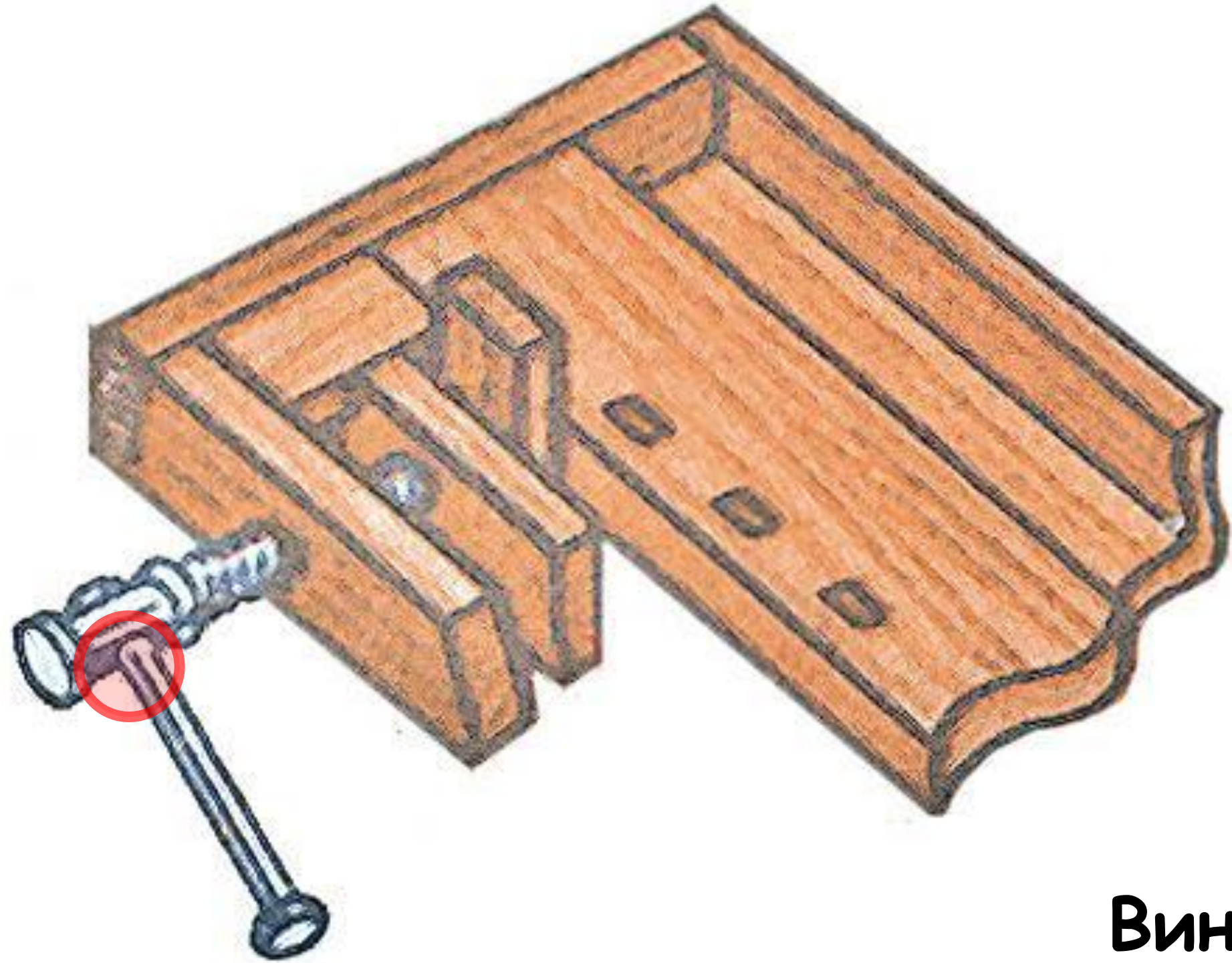

ВИНТ

ЗАДНИЕ ТИСКИ

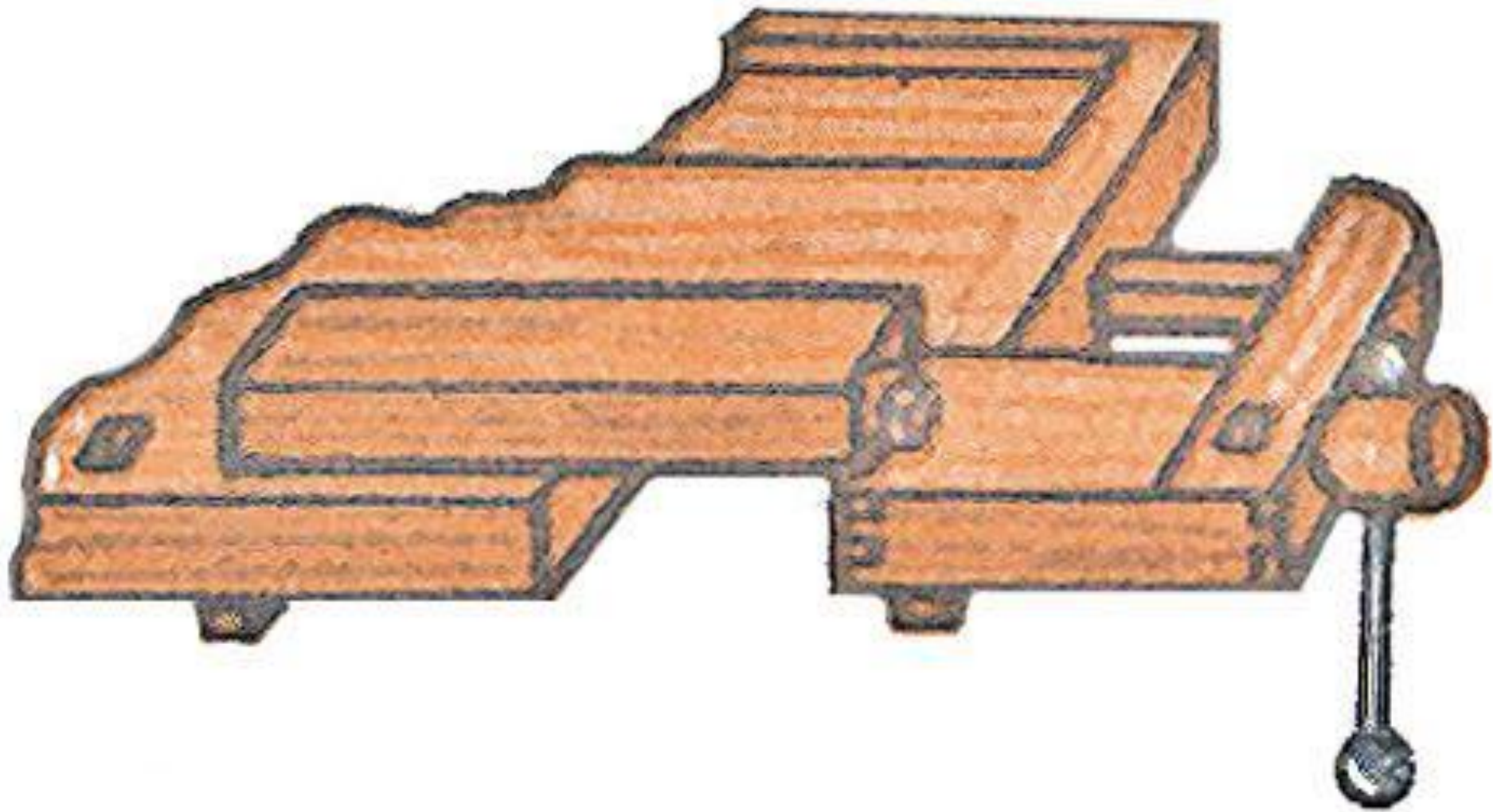

Коробка тисков

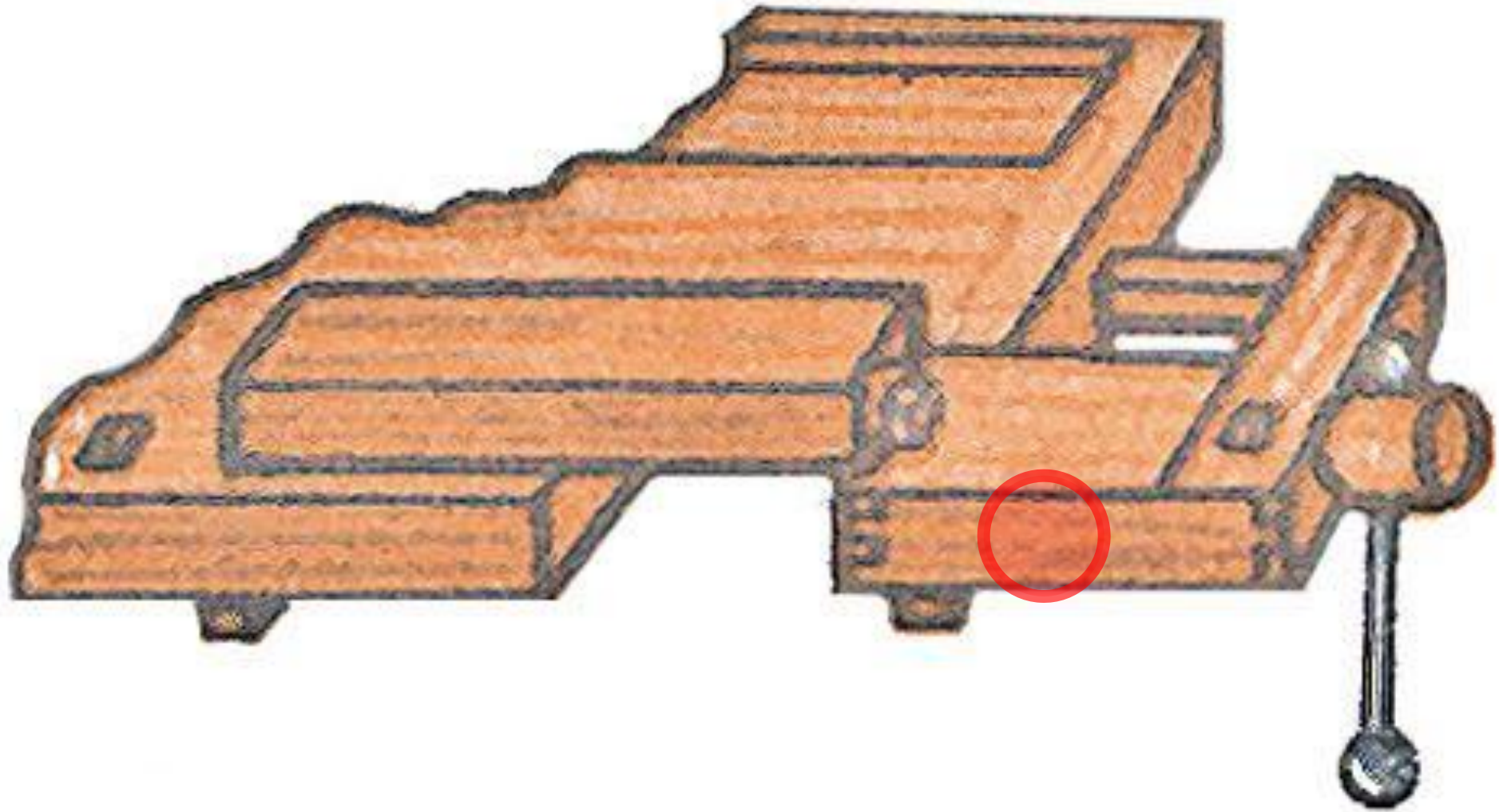



МОЛОТОК



КИЯНКА



ПЛОСКОГУБЦЫ



КЛЕЩИ



КЛЮЧИ ГАЕЧНЫЕ

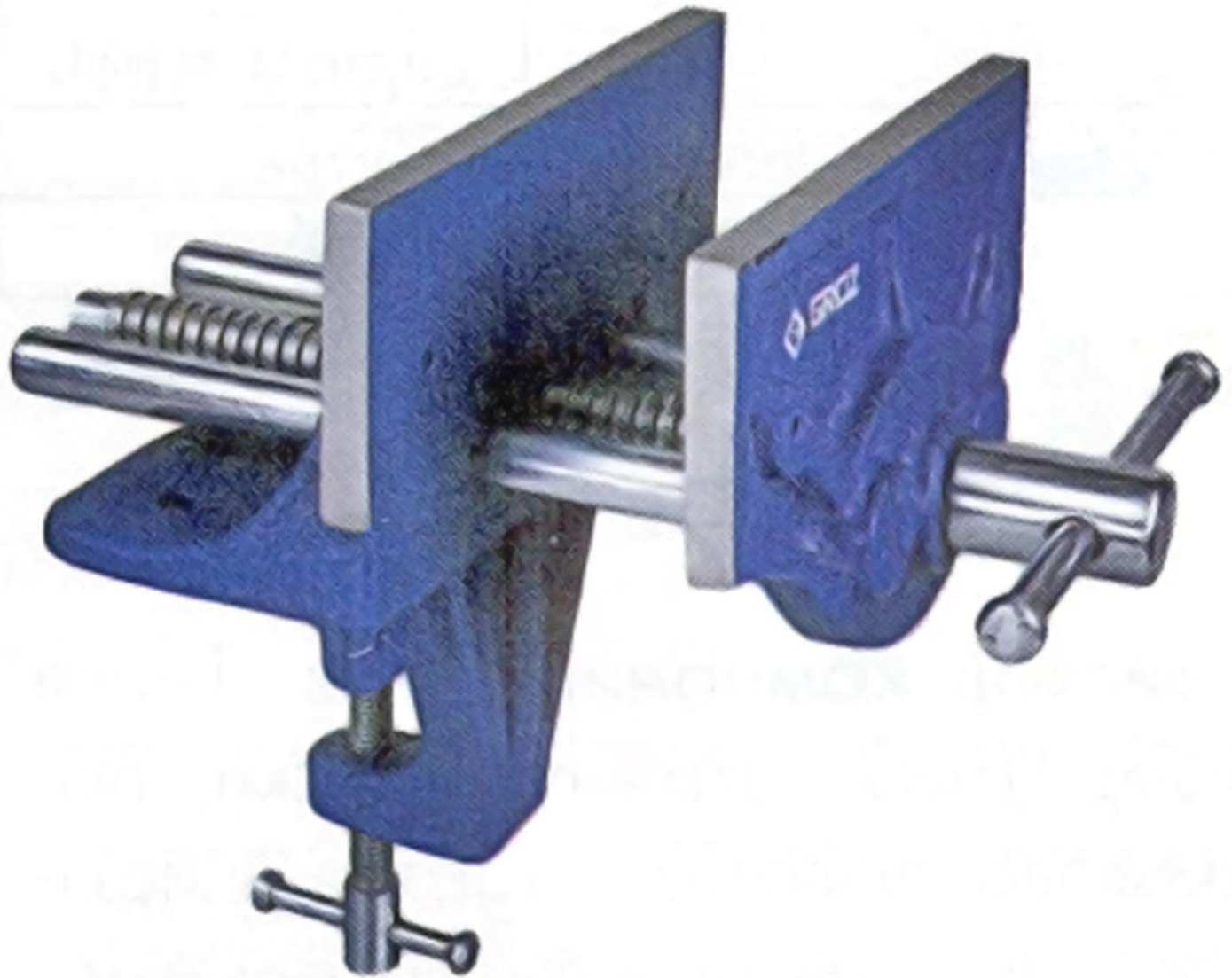

ТИСКИ

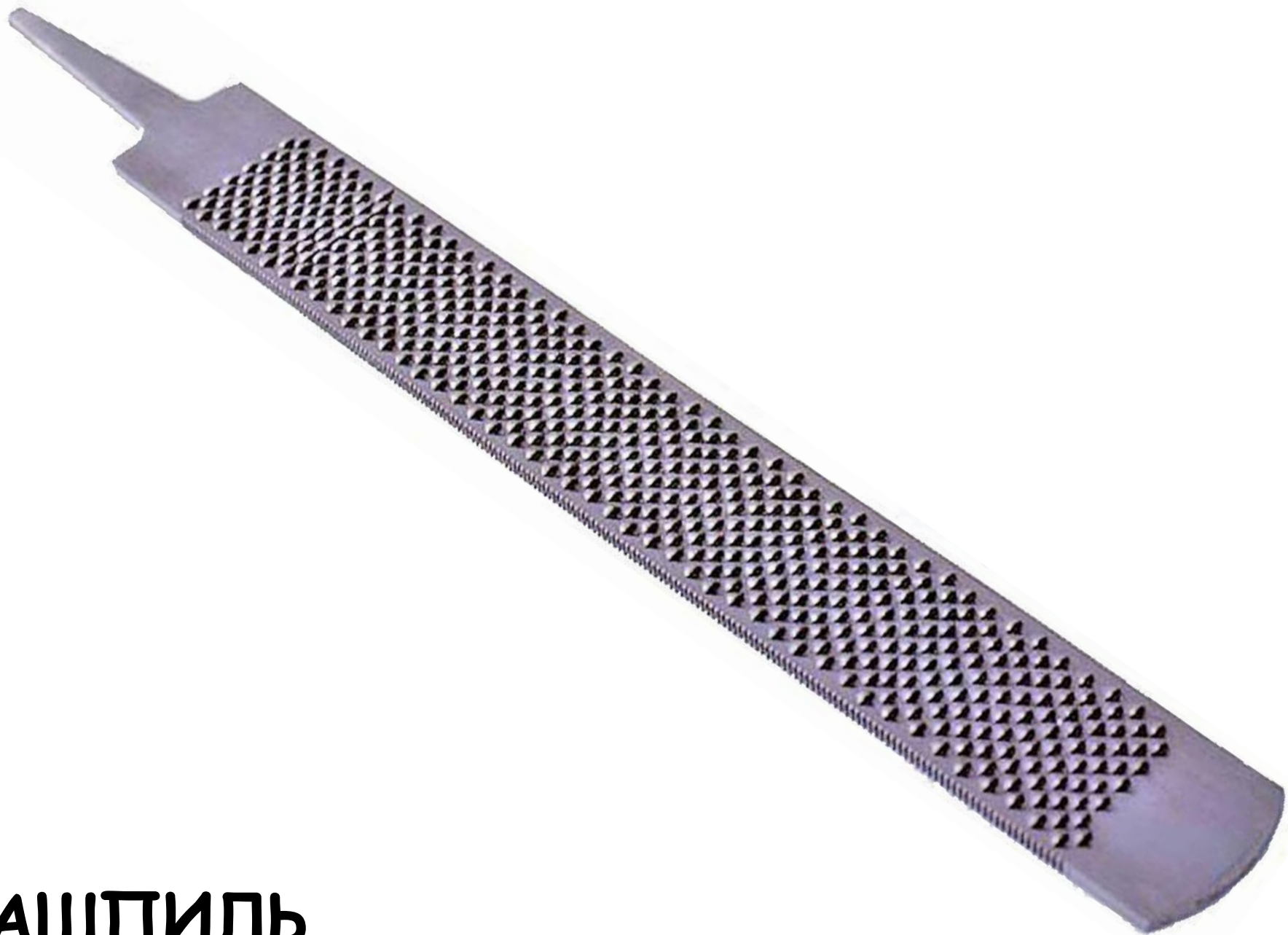

РАШТИЛЬ

СТРУБЦИНЫ

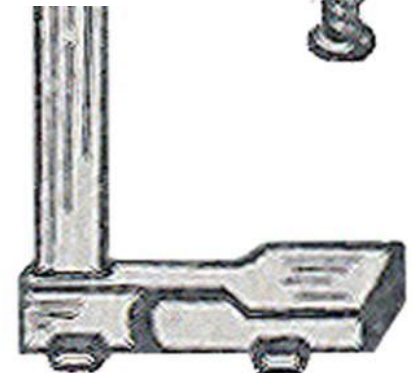
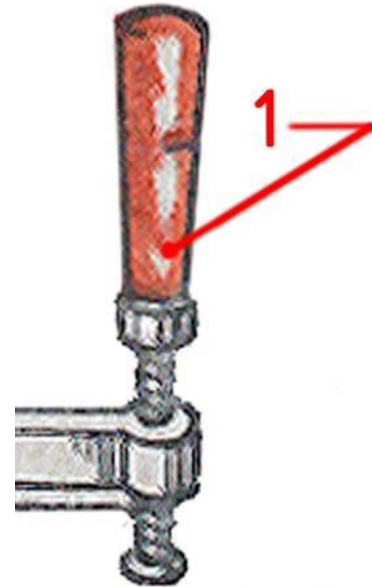
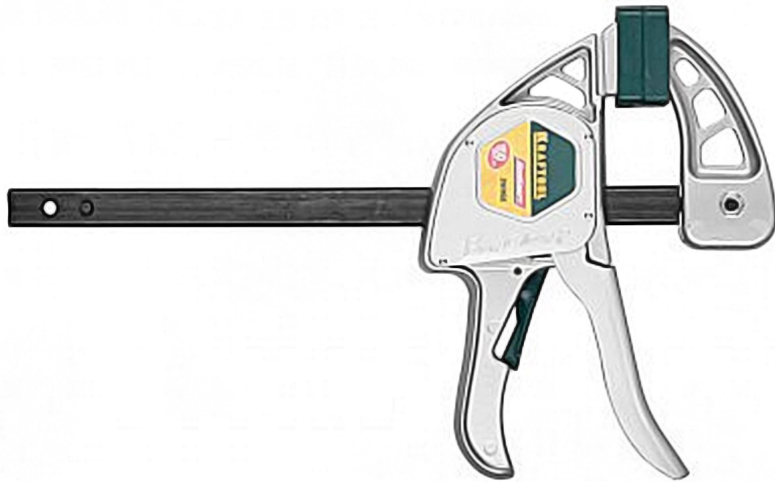

ЗАЖИМЫ И УПОРЫ

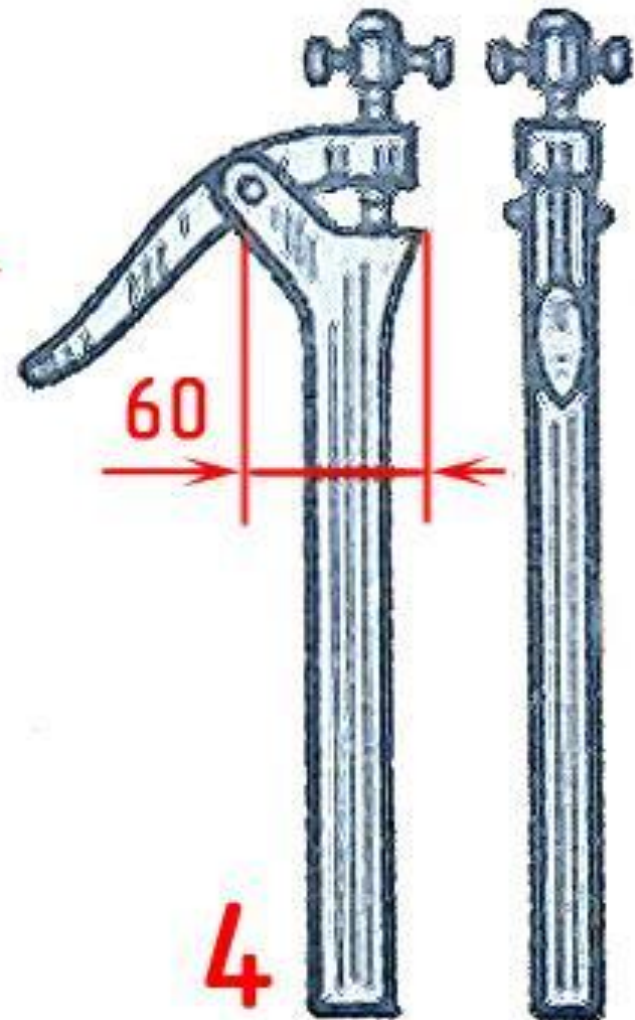
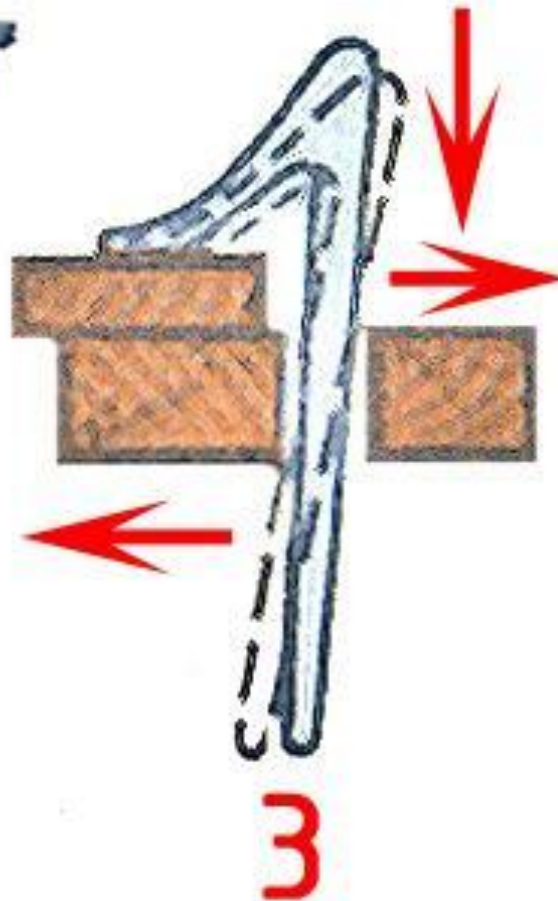

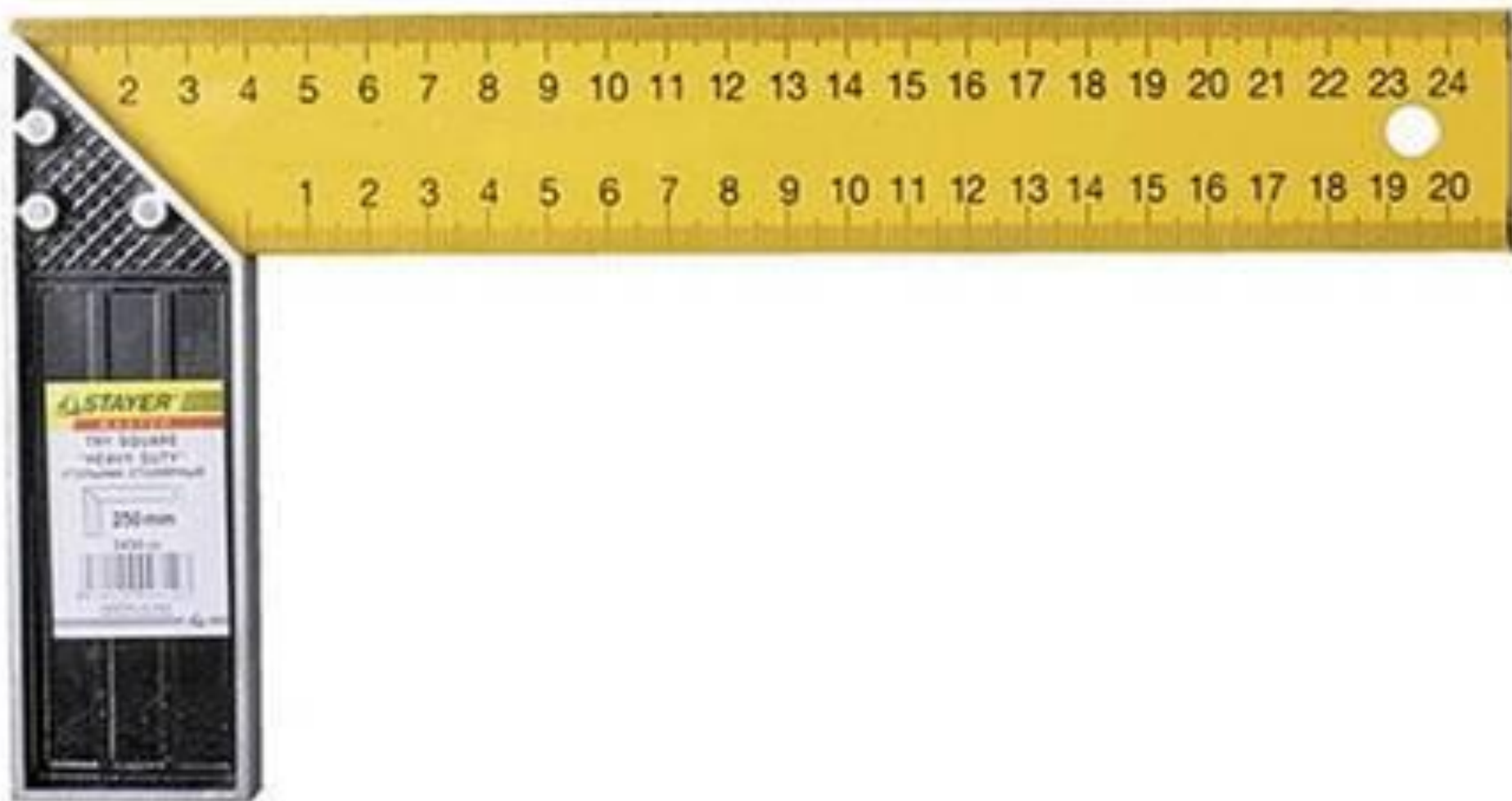

УГОЛЬНИК



МЕТР СКЛАДНОЙ

УРОВЕНЬ



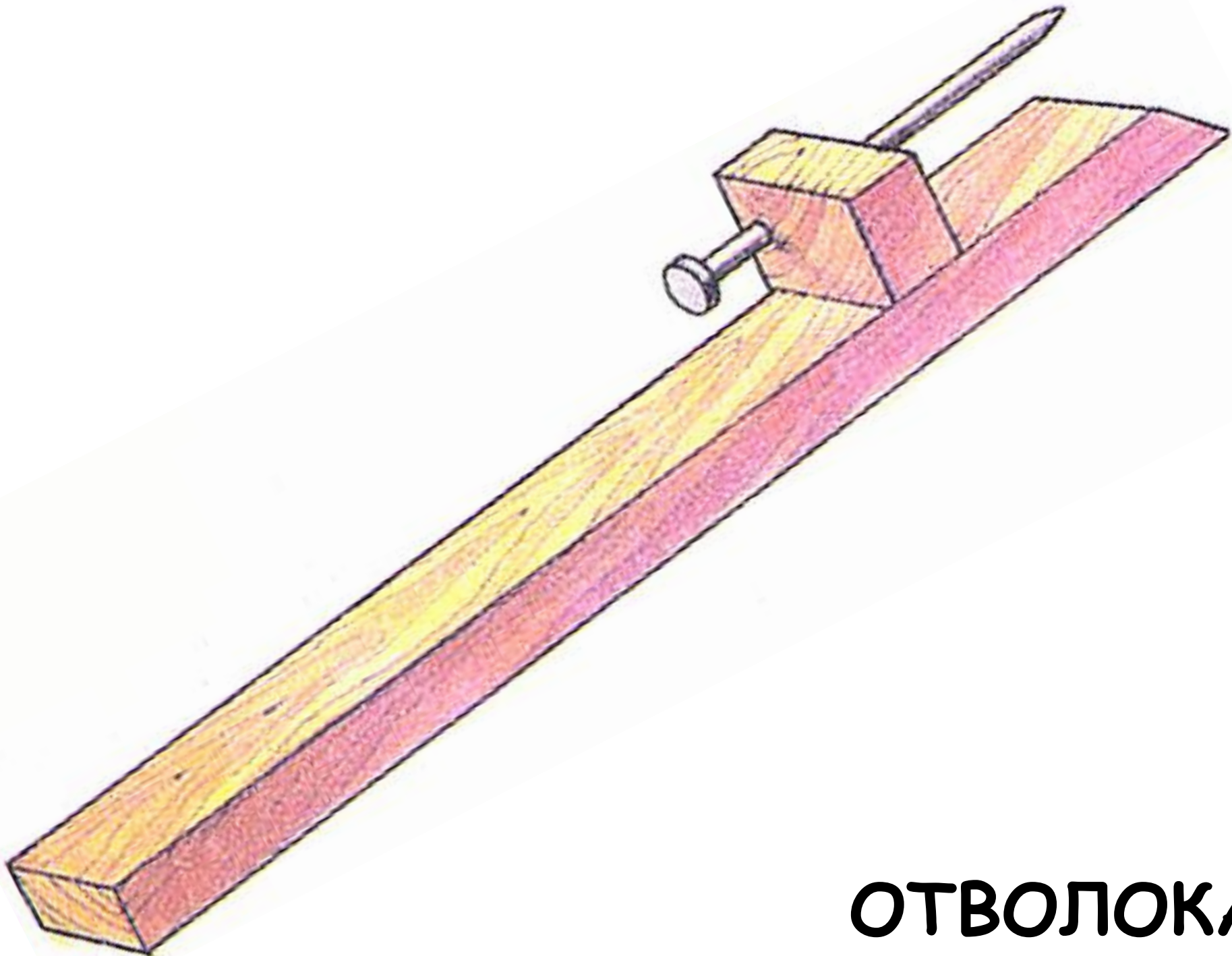

ОТВОЛОКА

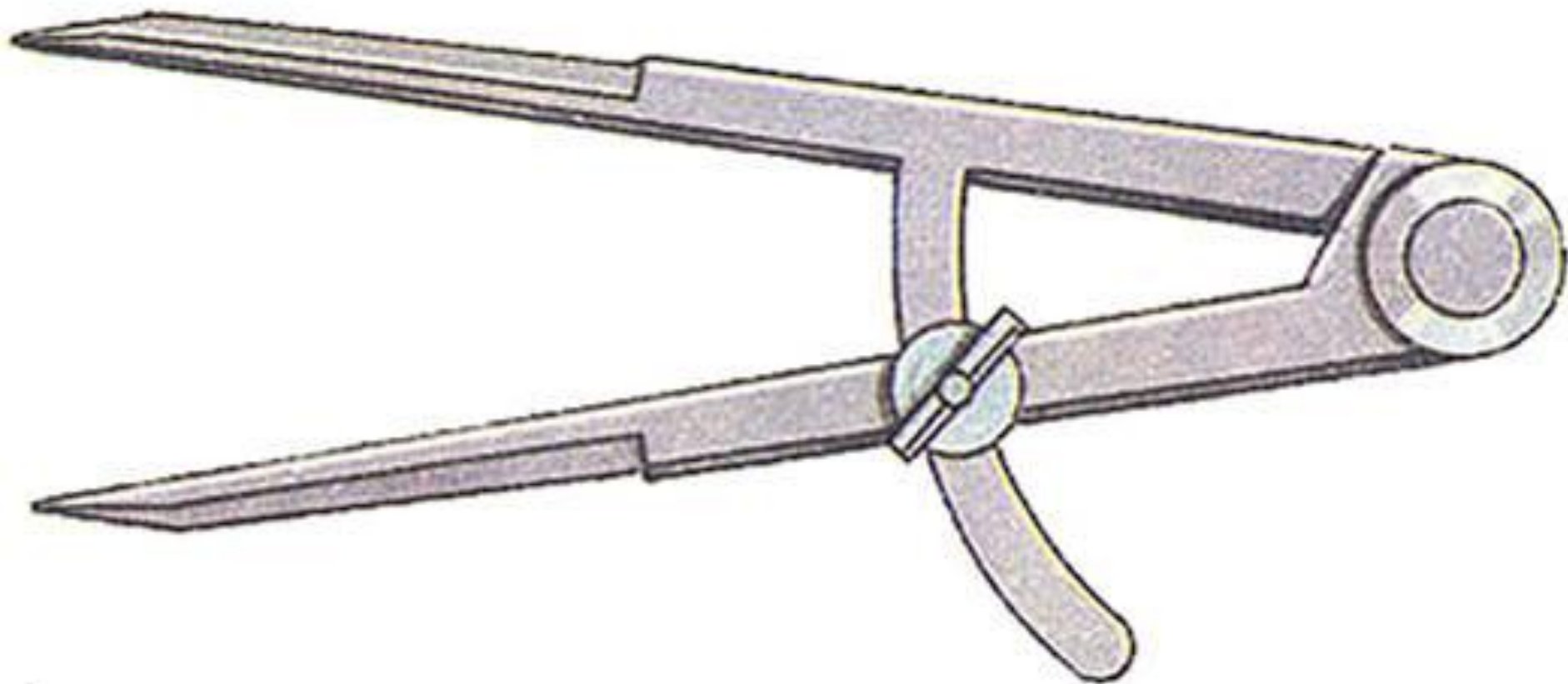

ЦИРКУЛЬ



КРОНЦИРКУЛЬ

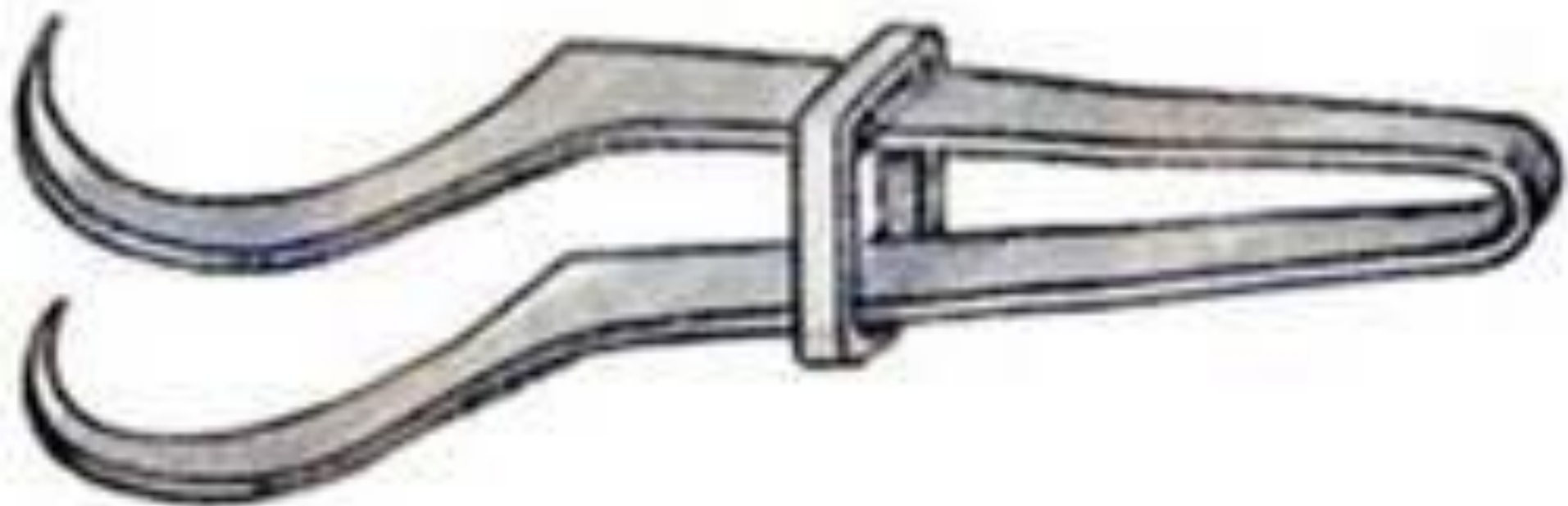

ЧЕРТА

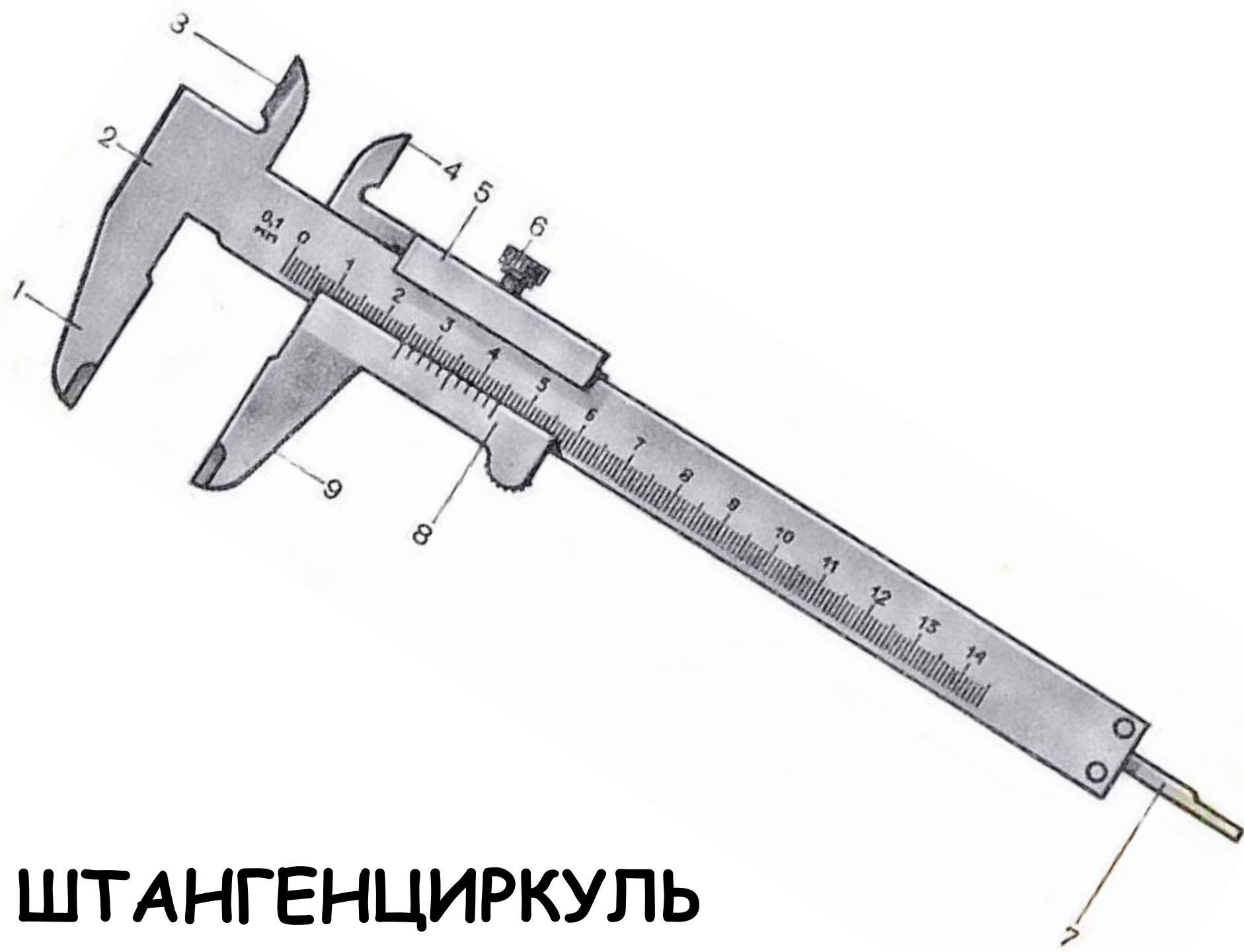

ШТАНГЕНЦИРКУЛЬ

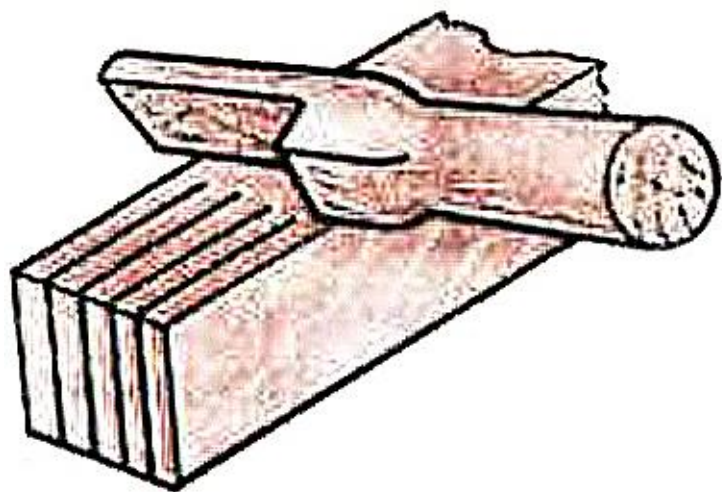

СКОБА

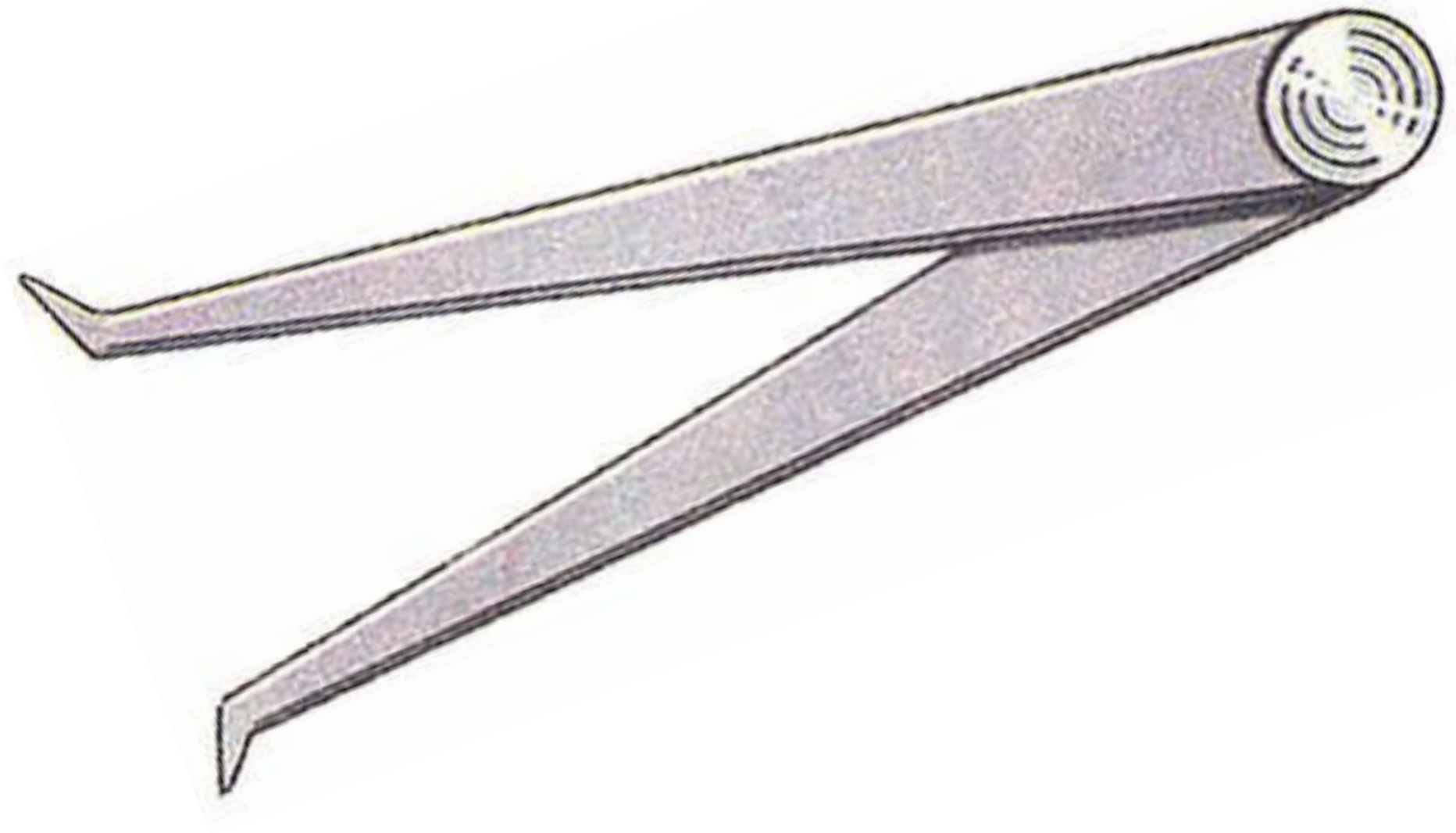

НУТРОМЕР



РУЛЕТКА



MAJ IKA

ЕРУНОК

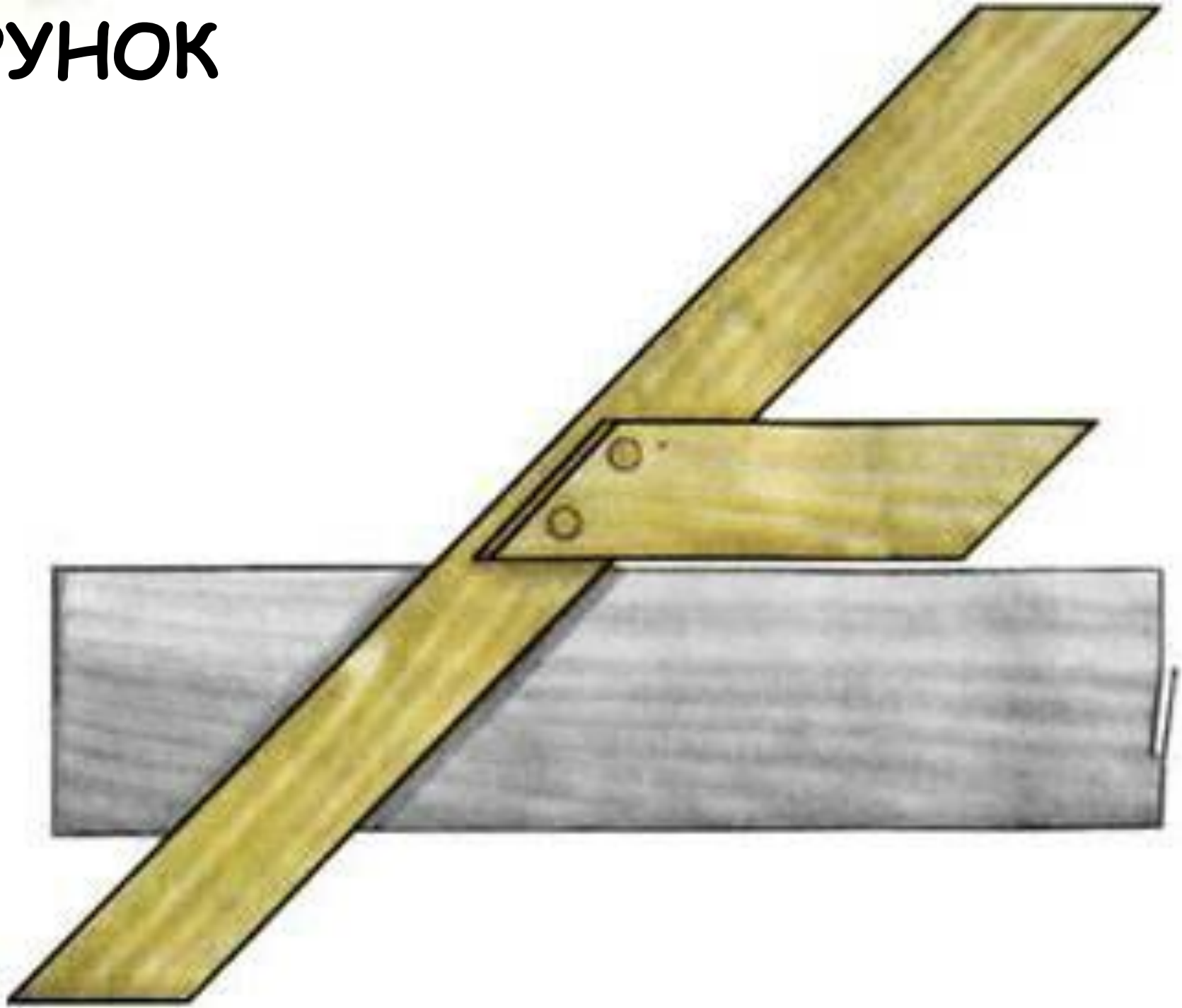

OTBEC



(495) 648-62-82
(800) 313-82-82
(343) 228-82-04

www.f1.ru/otbec/

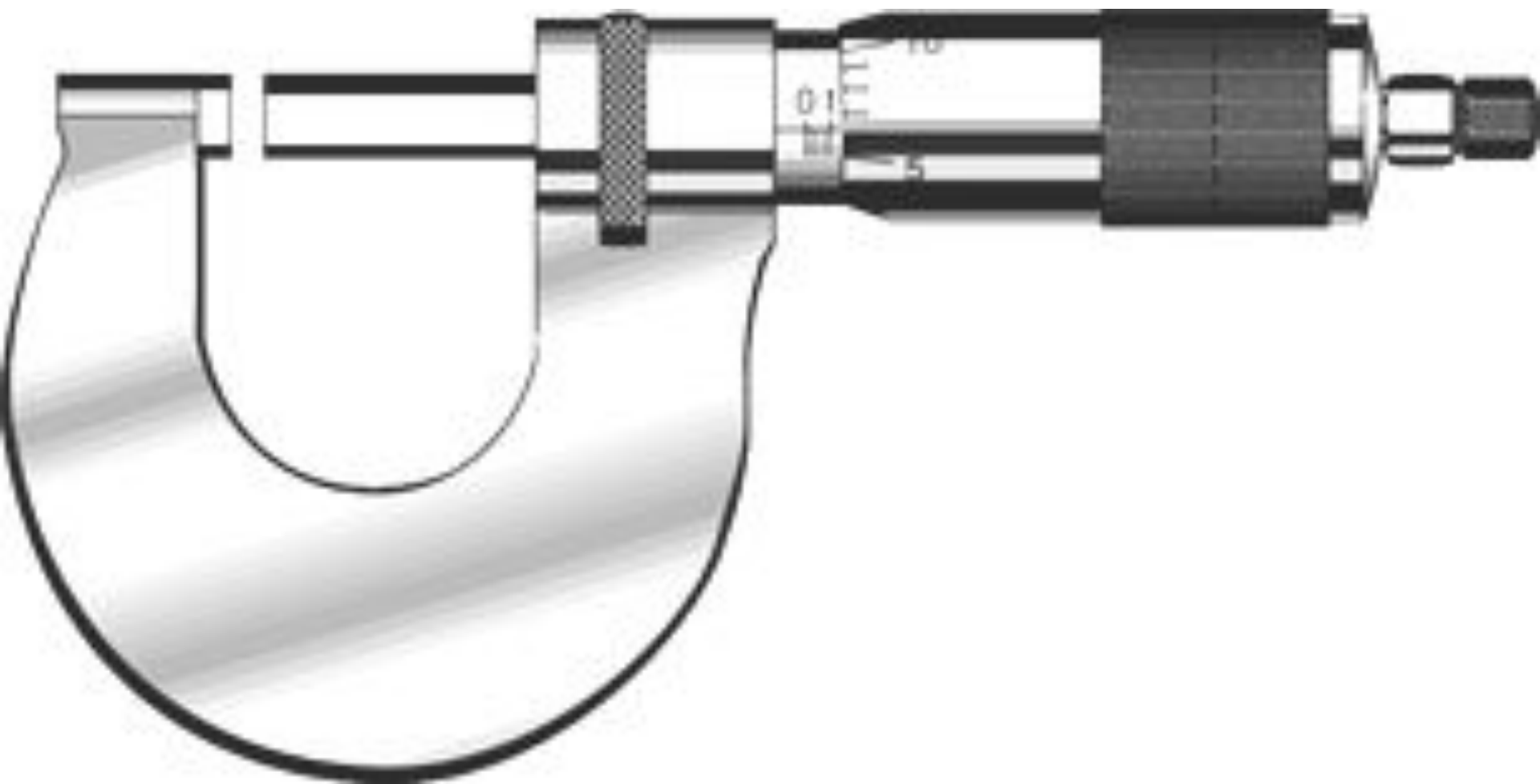

МИКРОМЕТР

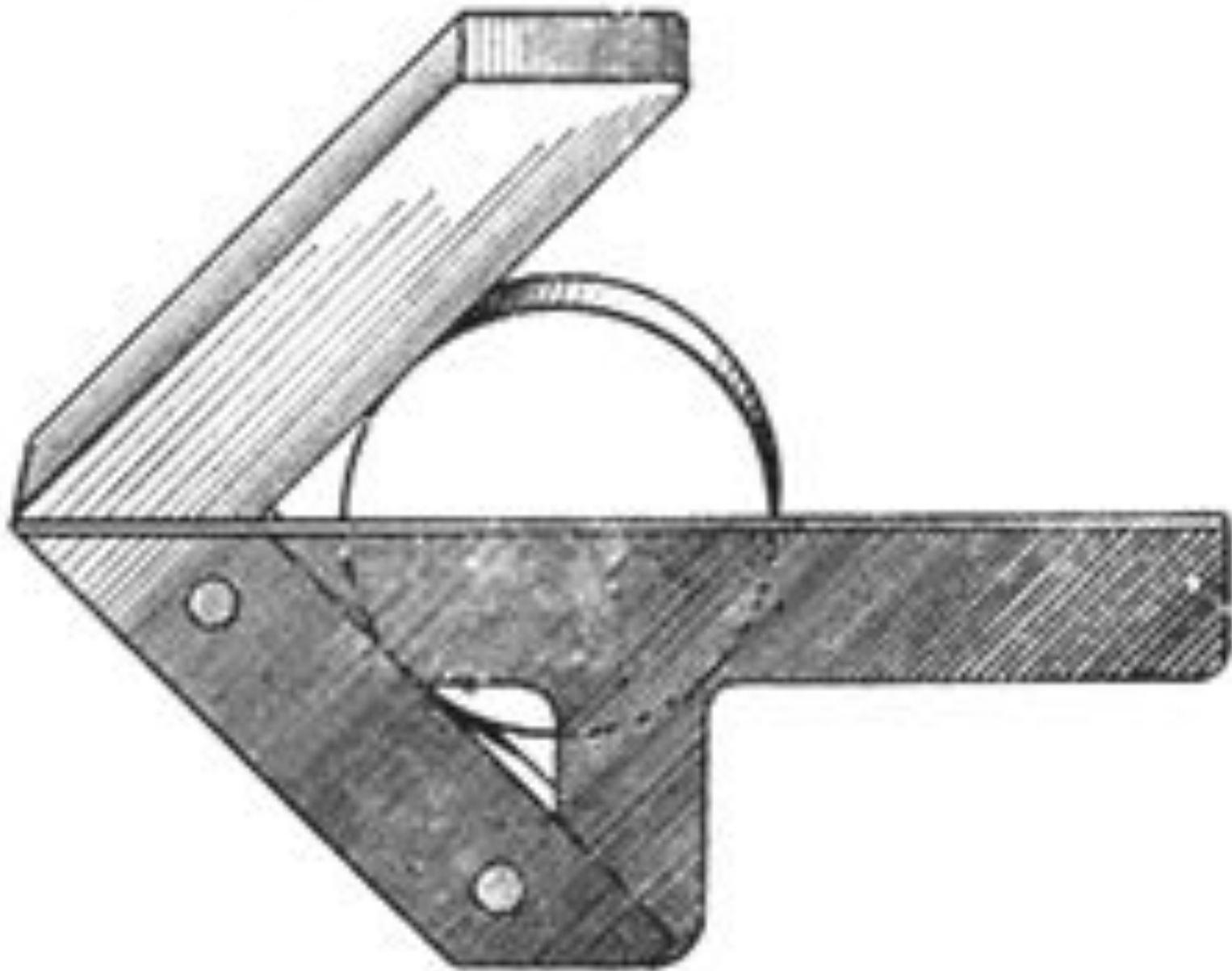

ЦЕНТРОИСКАТЕЛЬ

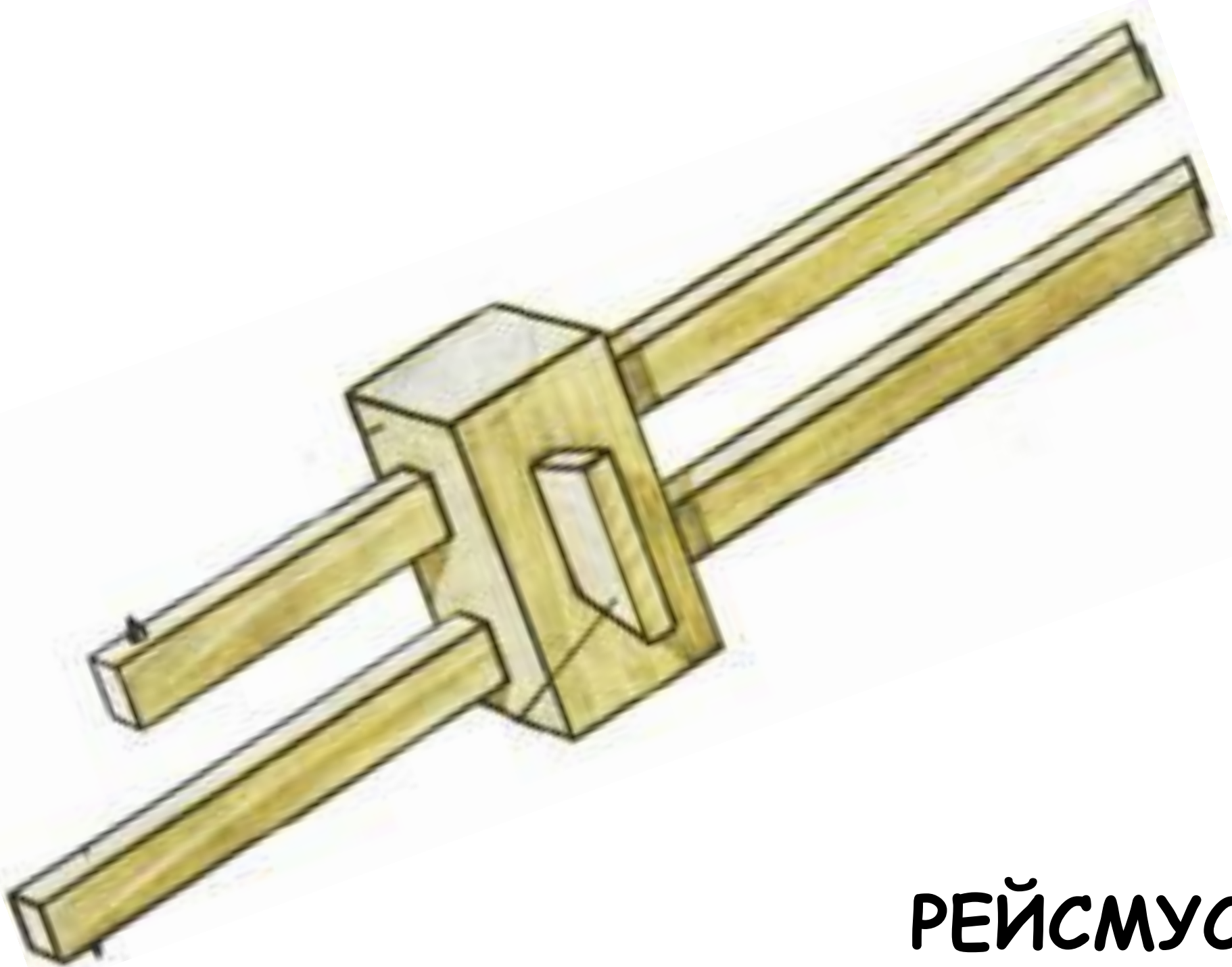

РЕЙСМУС



ПИЛА ЛУЧКОВАЯ

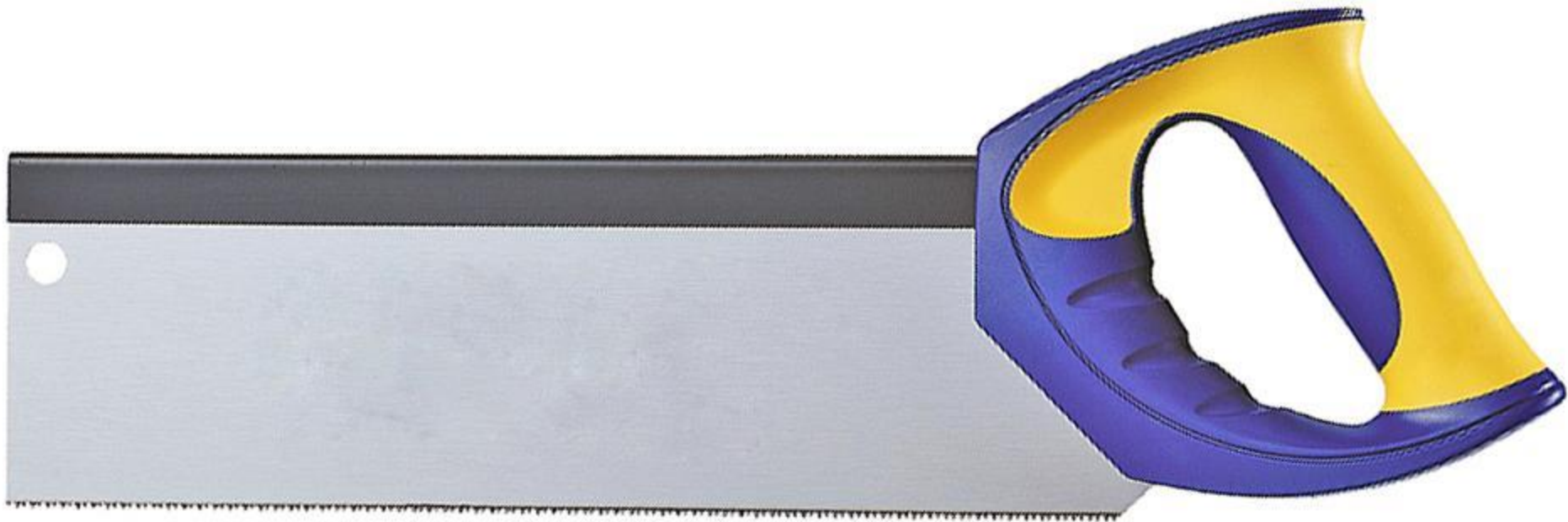

ПИЛА ОБУШКОВАЯ



ЭЛЕКТРОЛОБЗИК



САБЕЛЬНАЯ ЭЛЕКТРОПИЛА

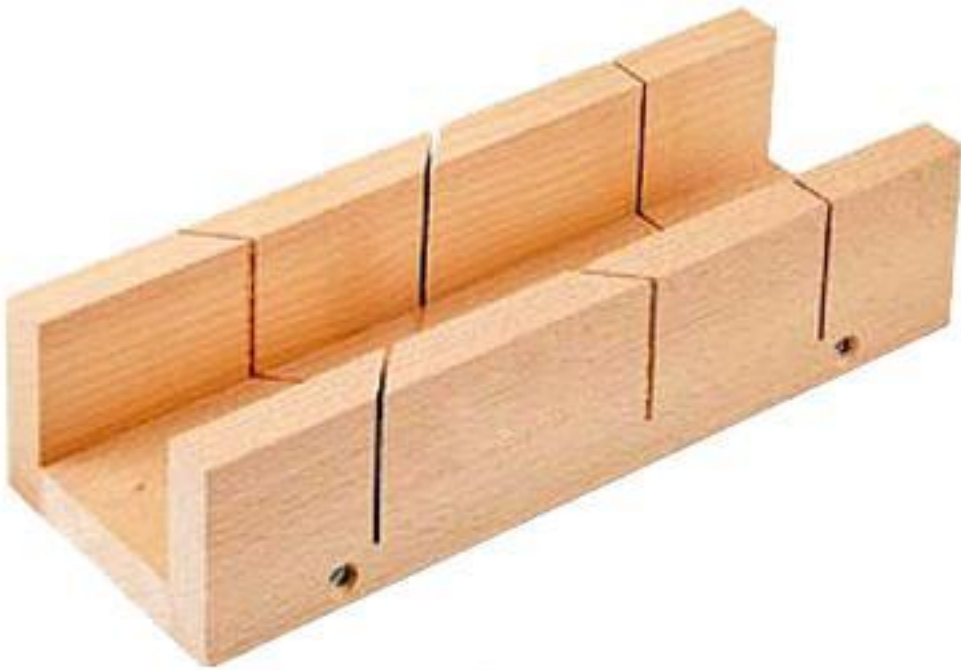

СТУСЛО



ЦЕПНАЯ ЭЛЕКТРОПИЛА



РУЧНАЯ ДИСКОВАЯ ЭЛЕКТРОПИЛА

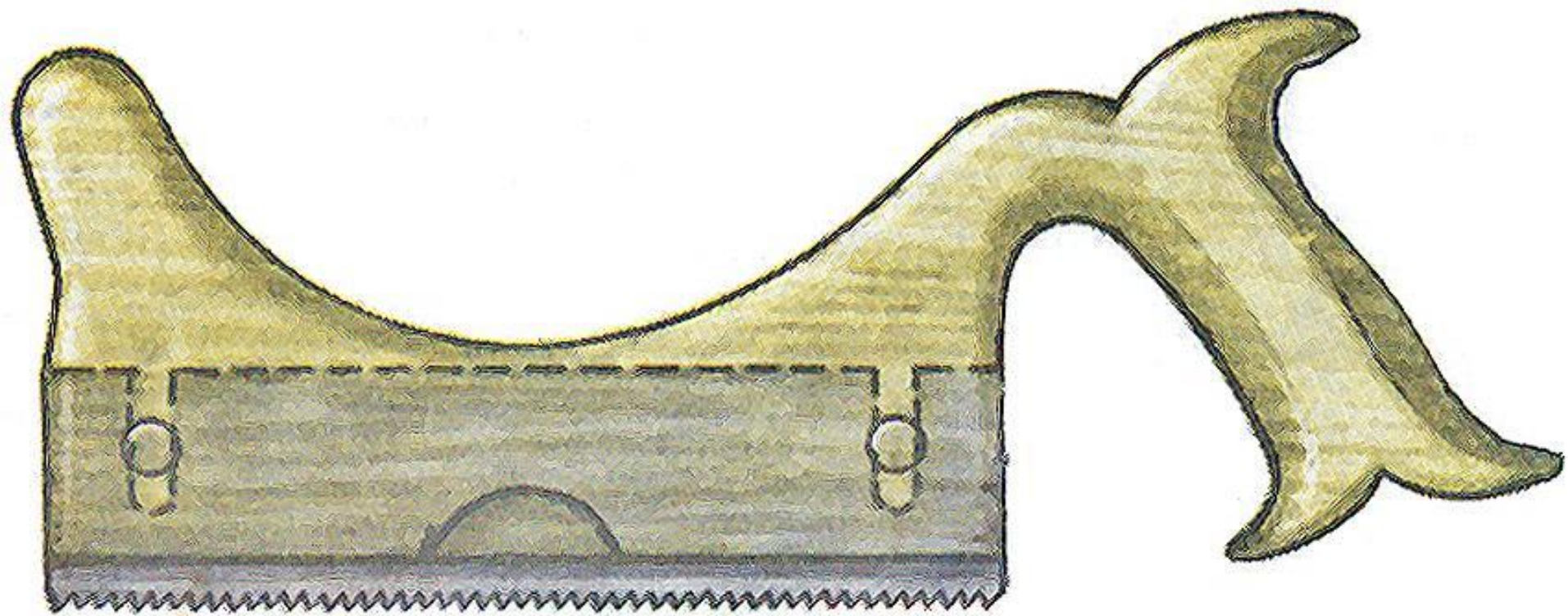

ПИЛА НАГРАДКА



ПИЛА ДВУРУЧНАЯ

НОЖОВКА УЗКАЯ



ЖОВКА ШИРОКАЯ



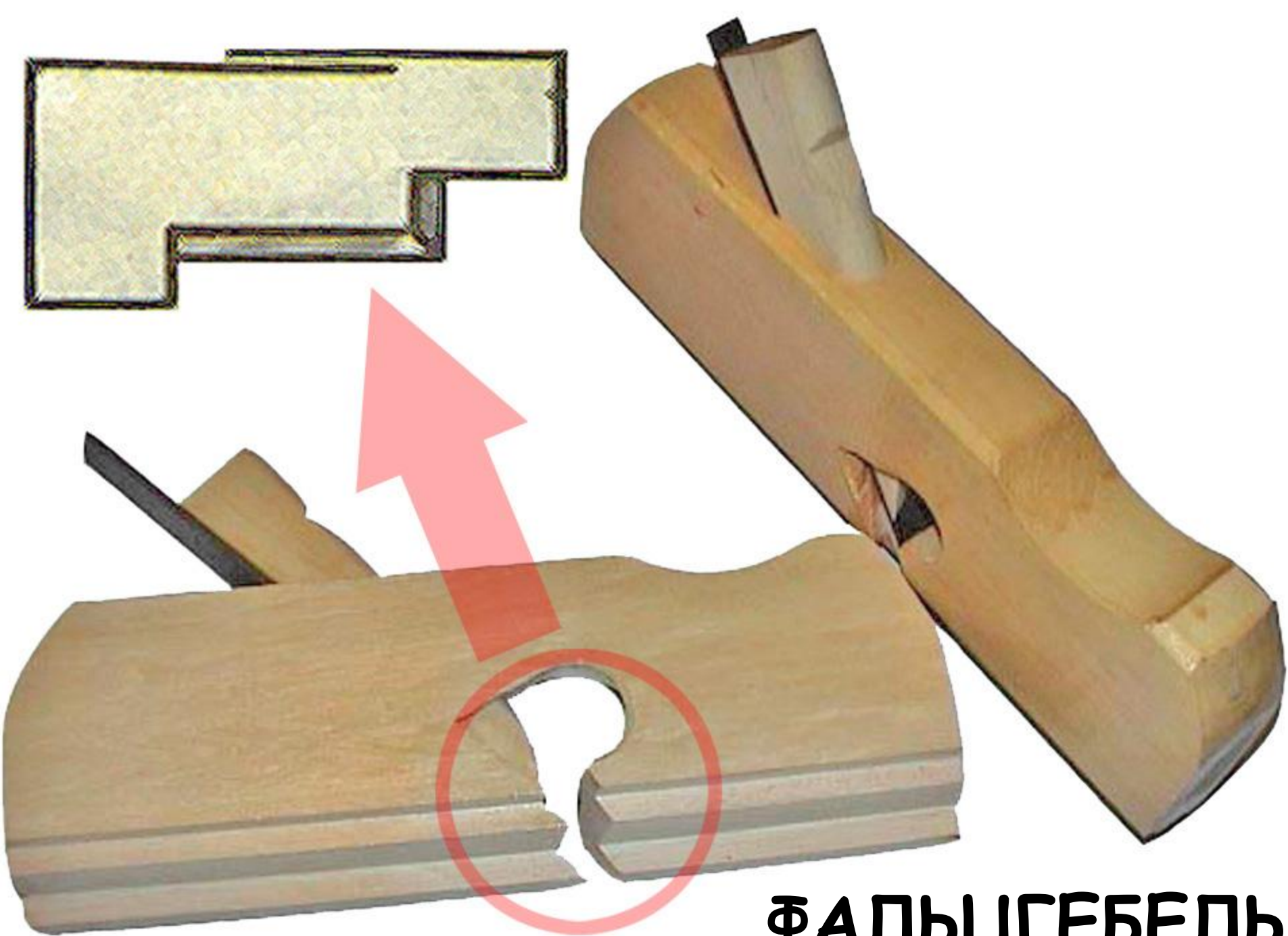

ФАЛЬЦГЕБЕЛЬ



ЭЛЕКТРОРУБАНОК

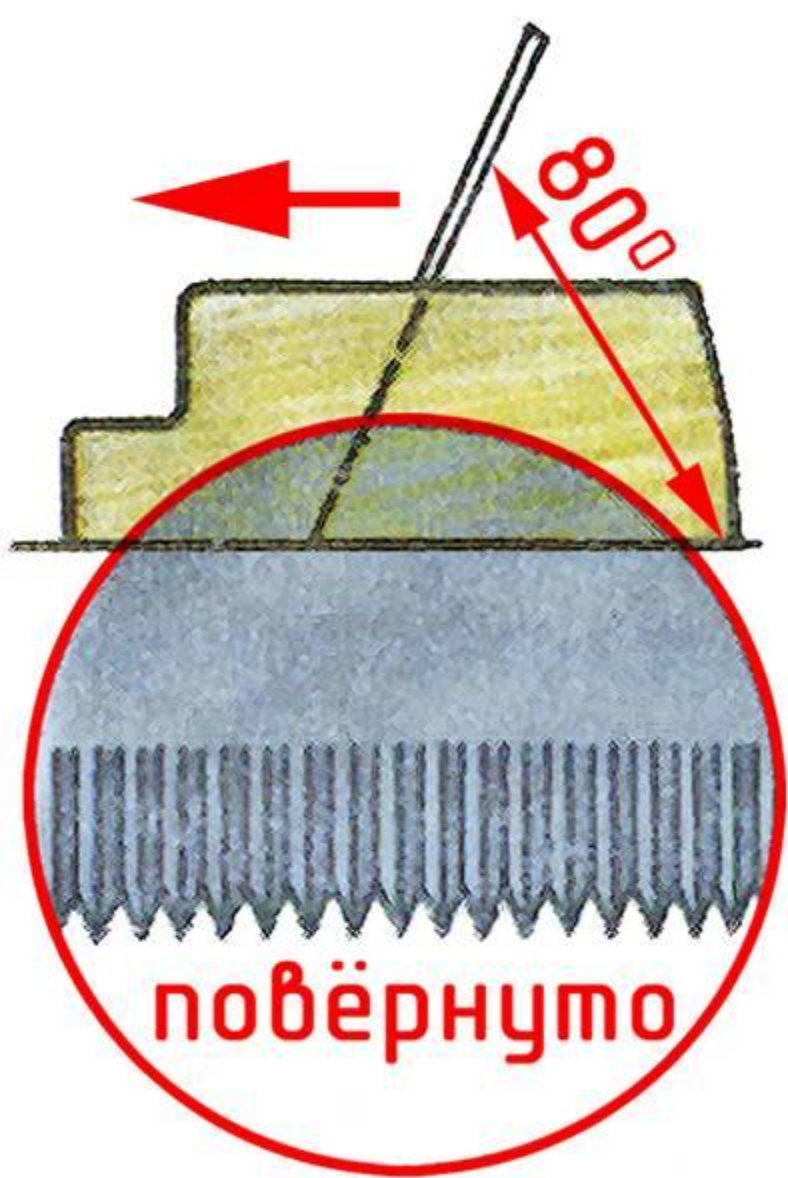

ЦИНУБЕЛЬ

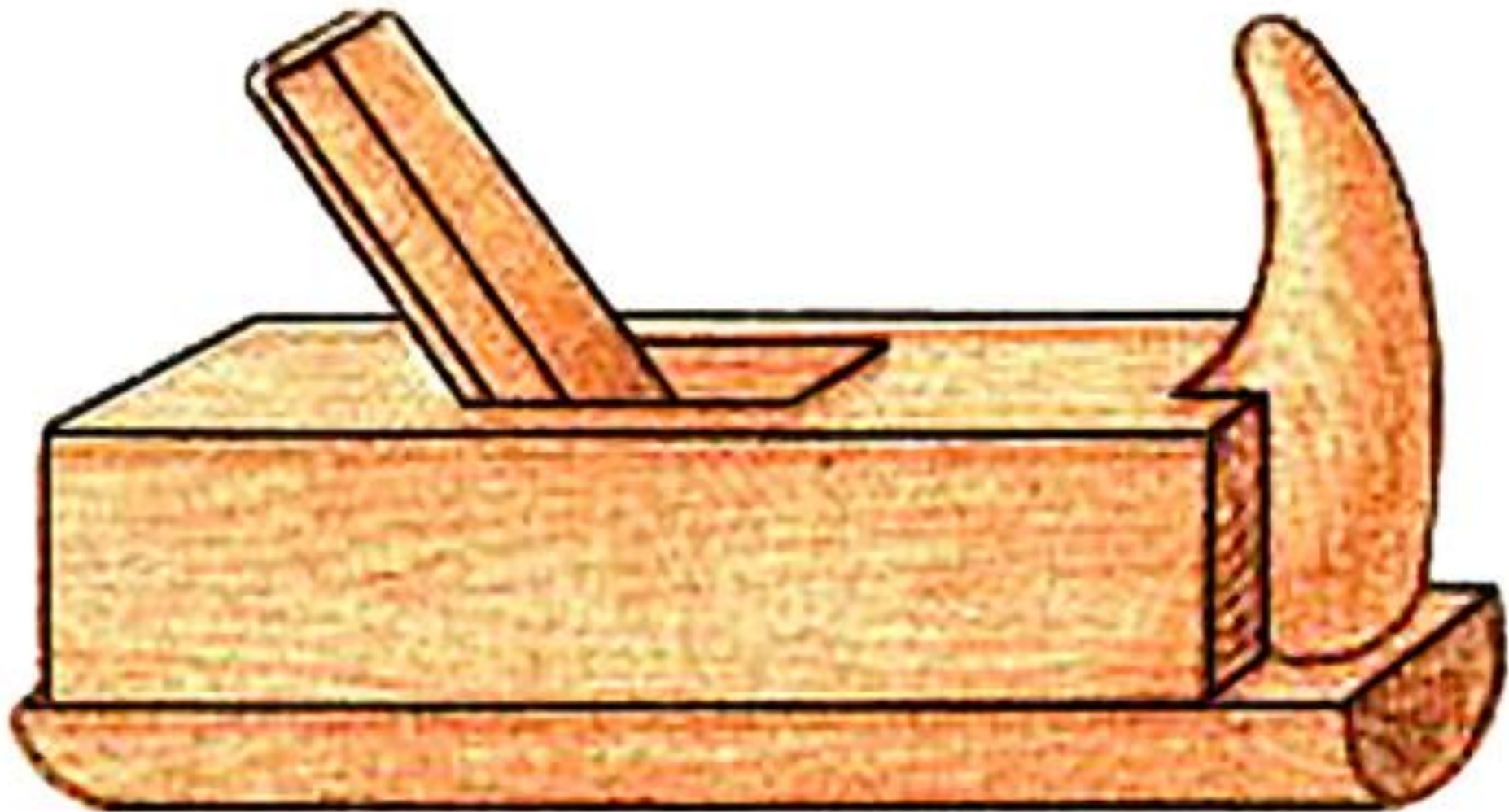

ГАЛТЕЛЬ

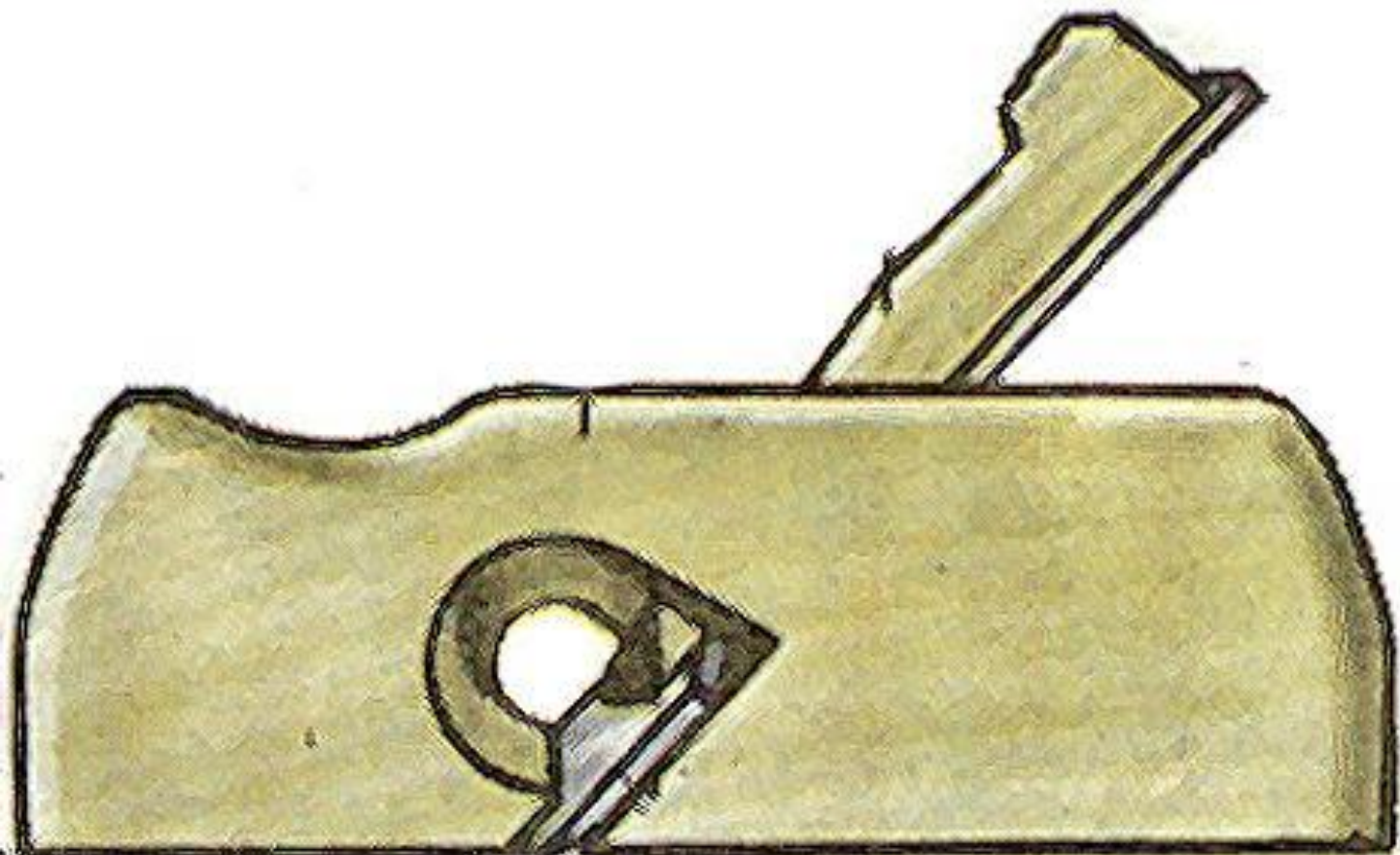

ЗЕНЗУБЕЛЬ



ВИБРАЦИОННАЯ ШЛИФМАШИНА



ФУГАНОК

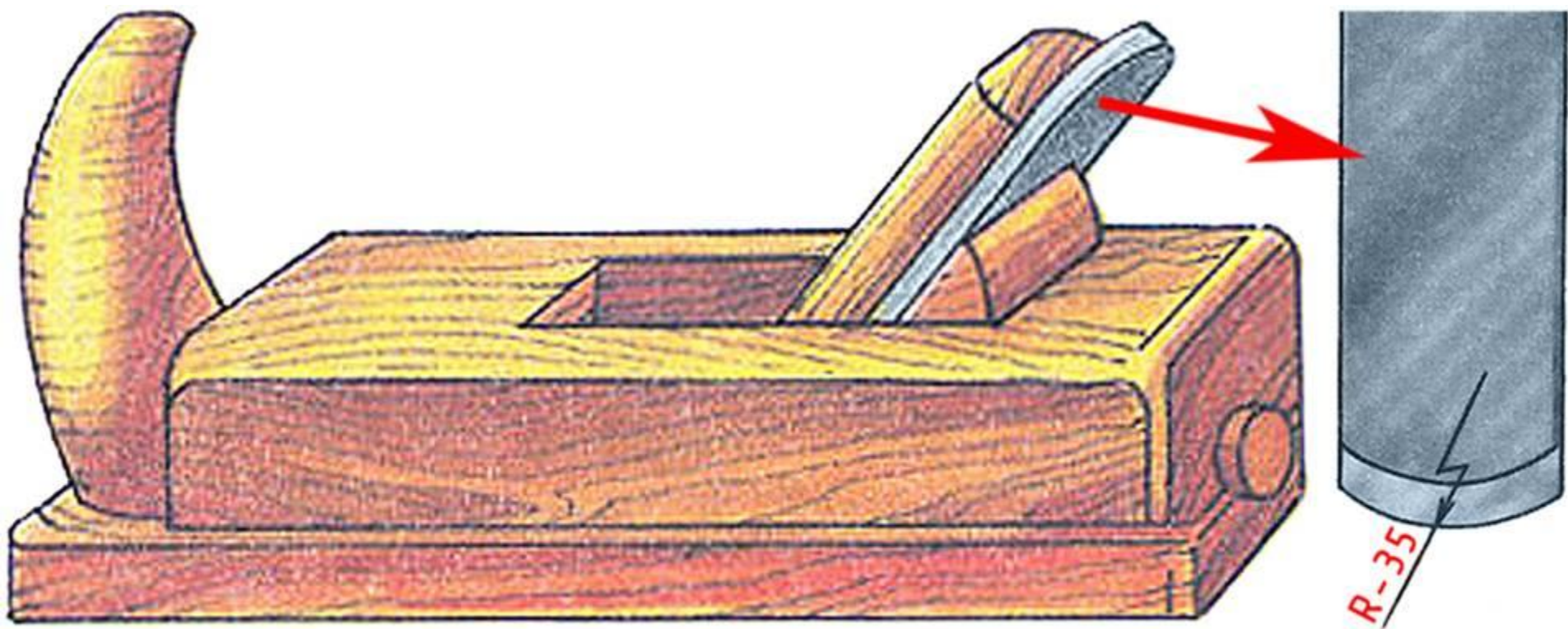

ШЕРХЕБЕЛЬ

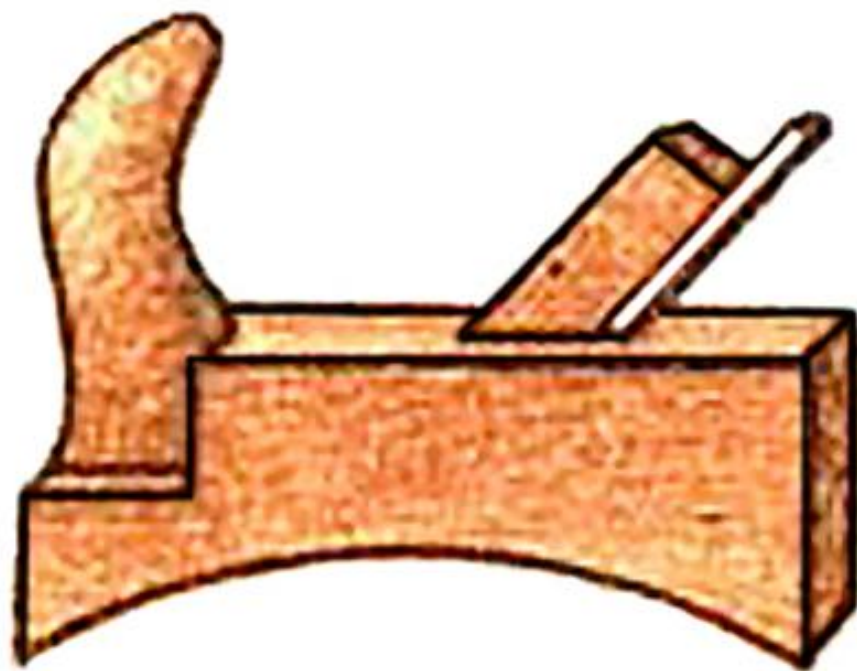
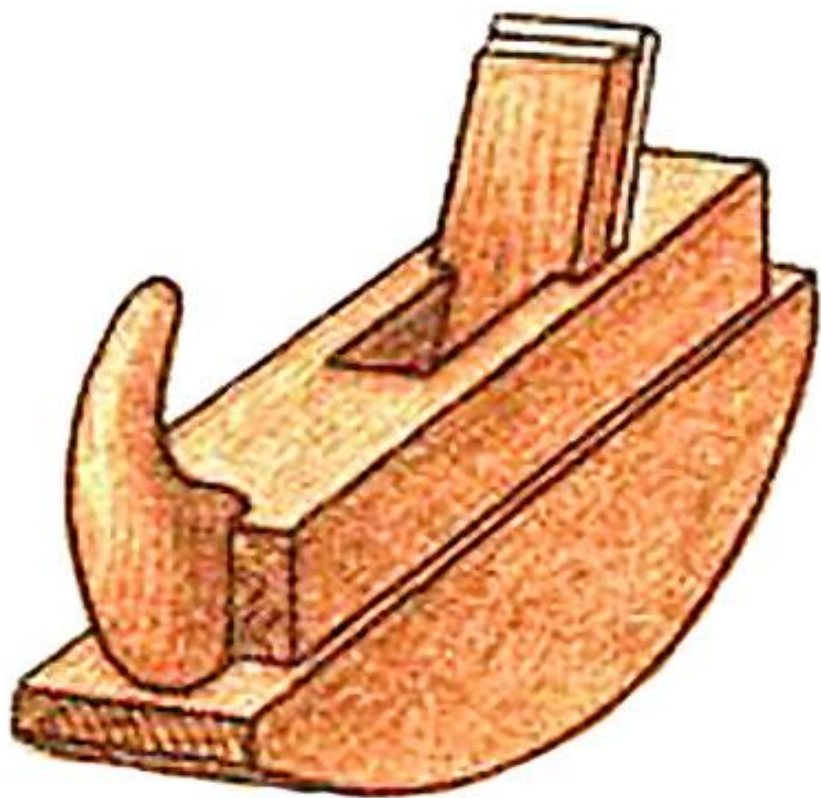

ГОРБАЧ

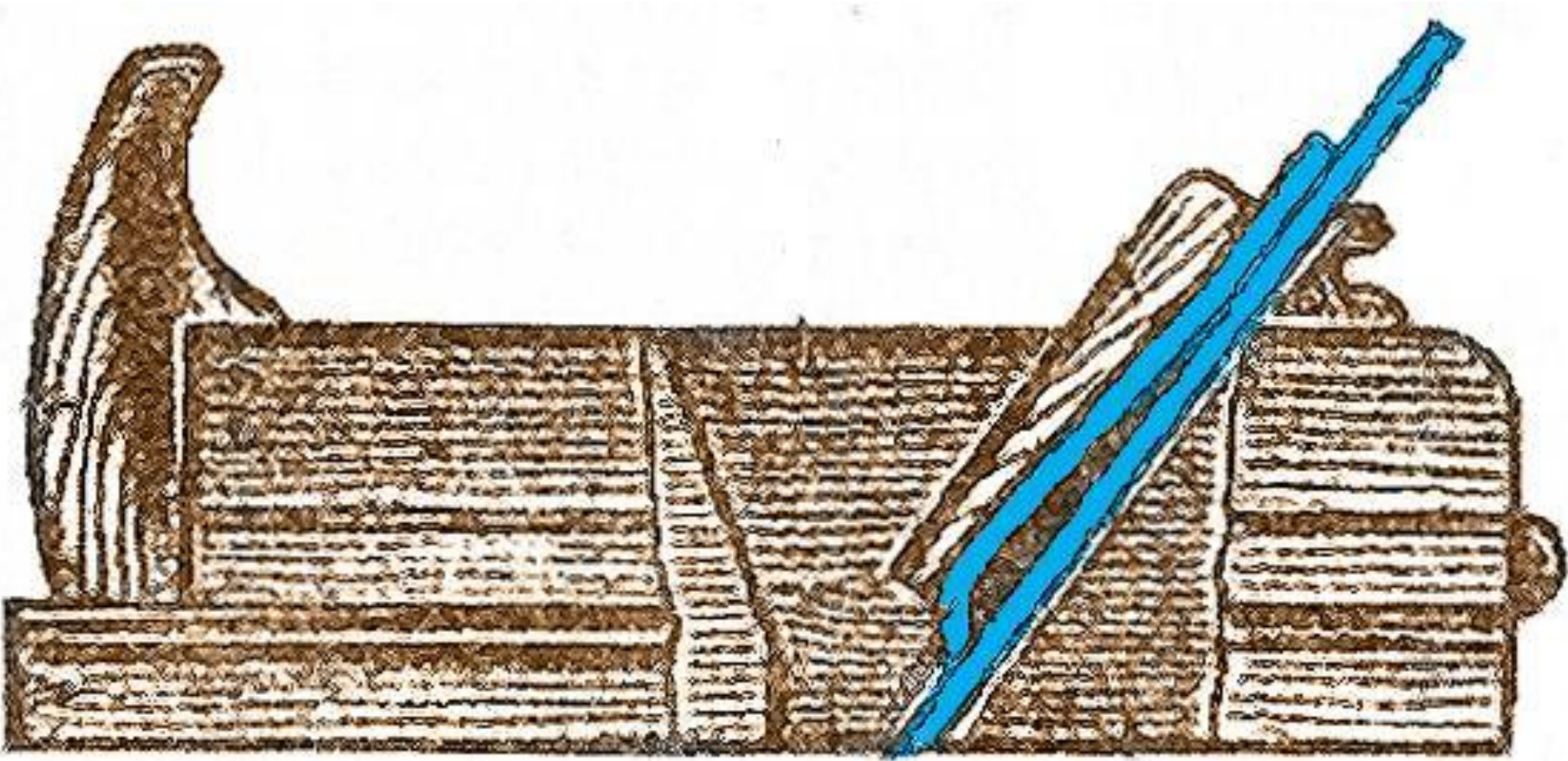

РУБАНОК С ДВОЙНЫМ НОЖОМ

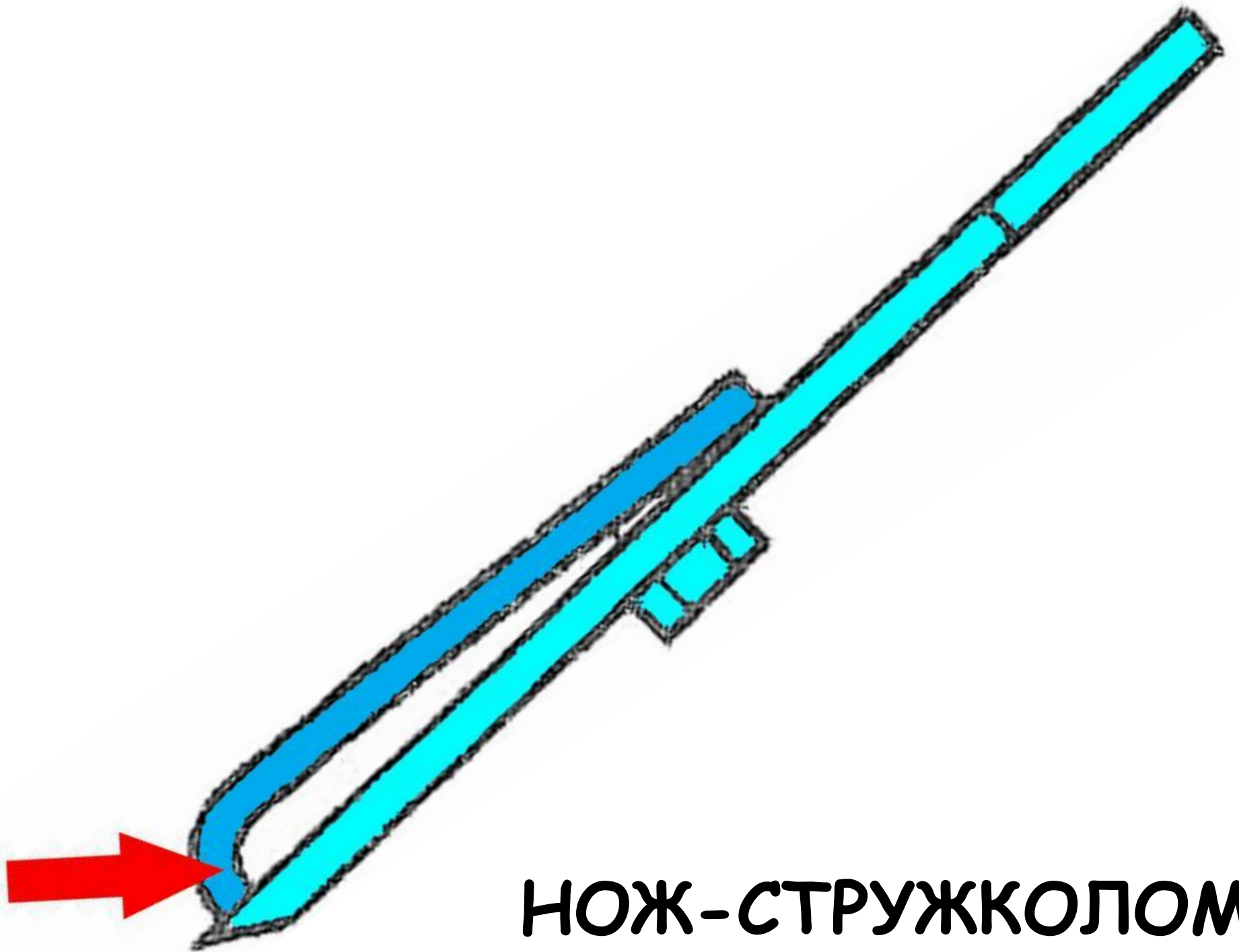

НОЖ-СТРУЖКОЛОМ



ЦИКЛЯ

ФРЕЗЕР РУЧНОЙ





ДОЛОТО



СТAMEЦКА

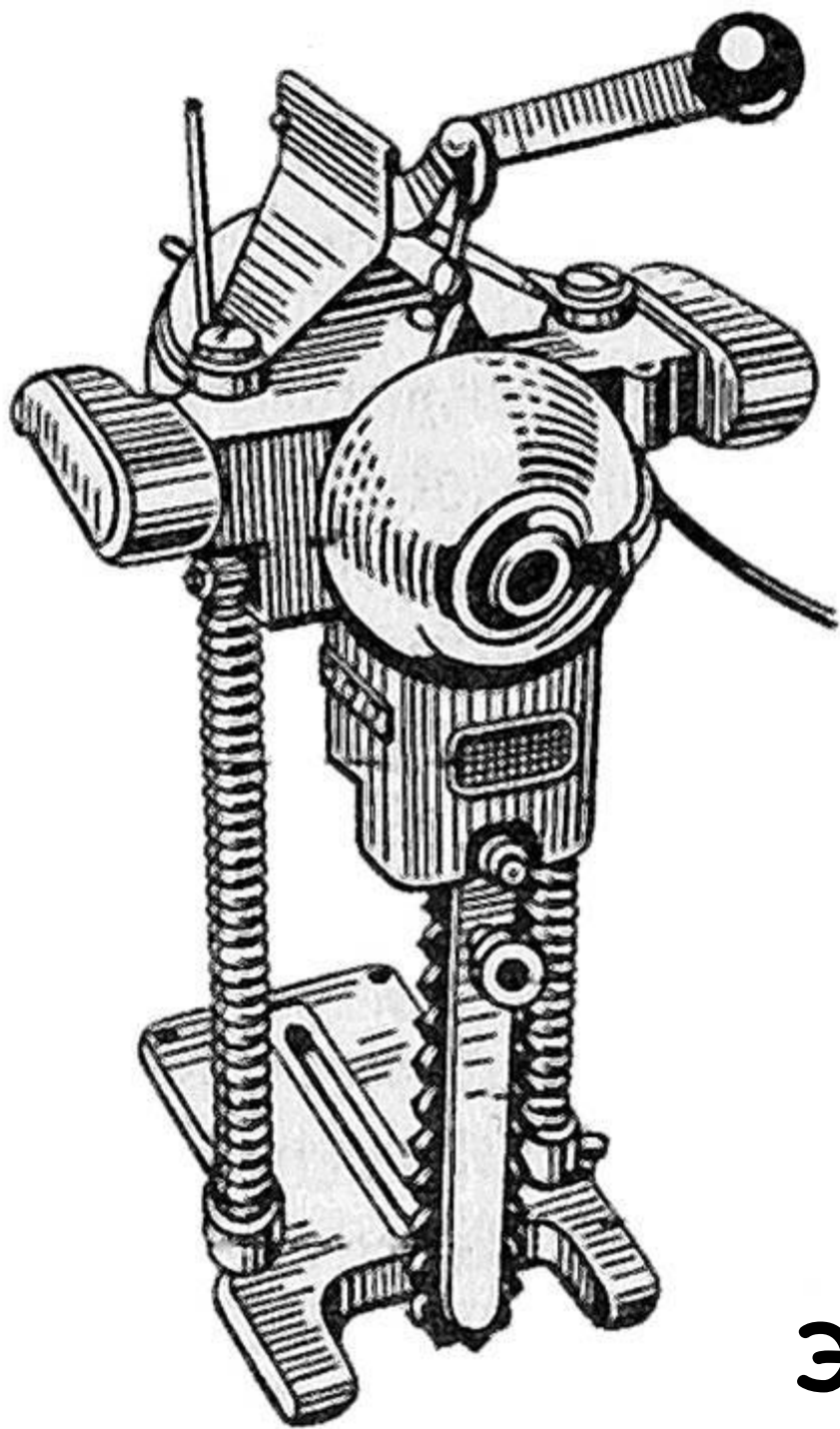

ЭЛЕКТРОДОЛБЁЖНИК



СВЕРЛЮ ФОРСТНЕРА

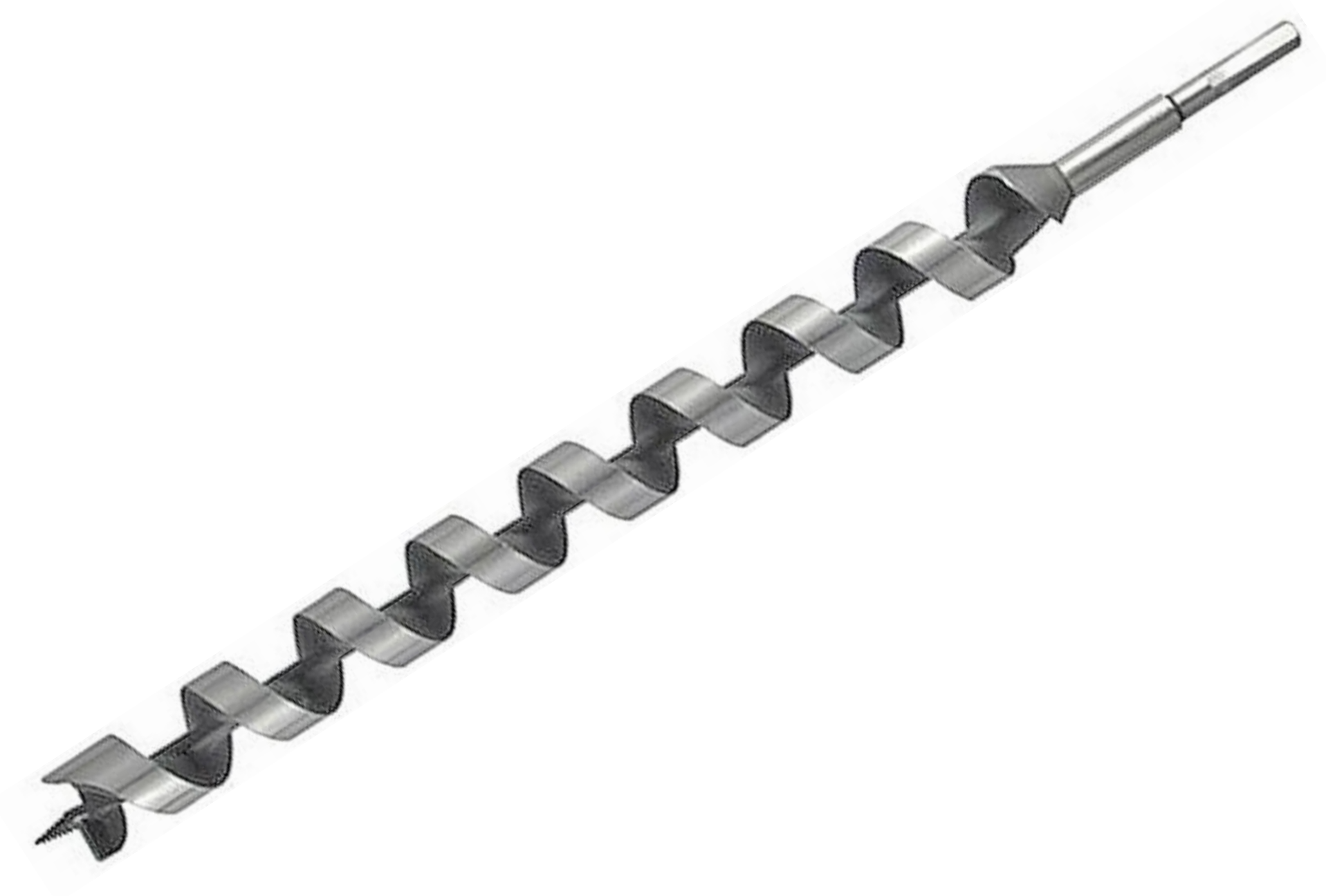

СВЕРЛО ВИНТОВОЕ

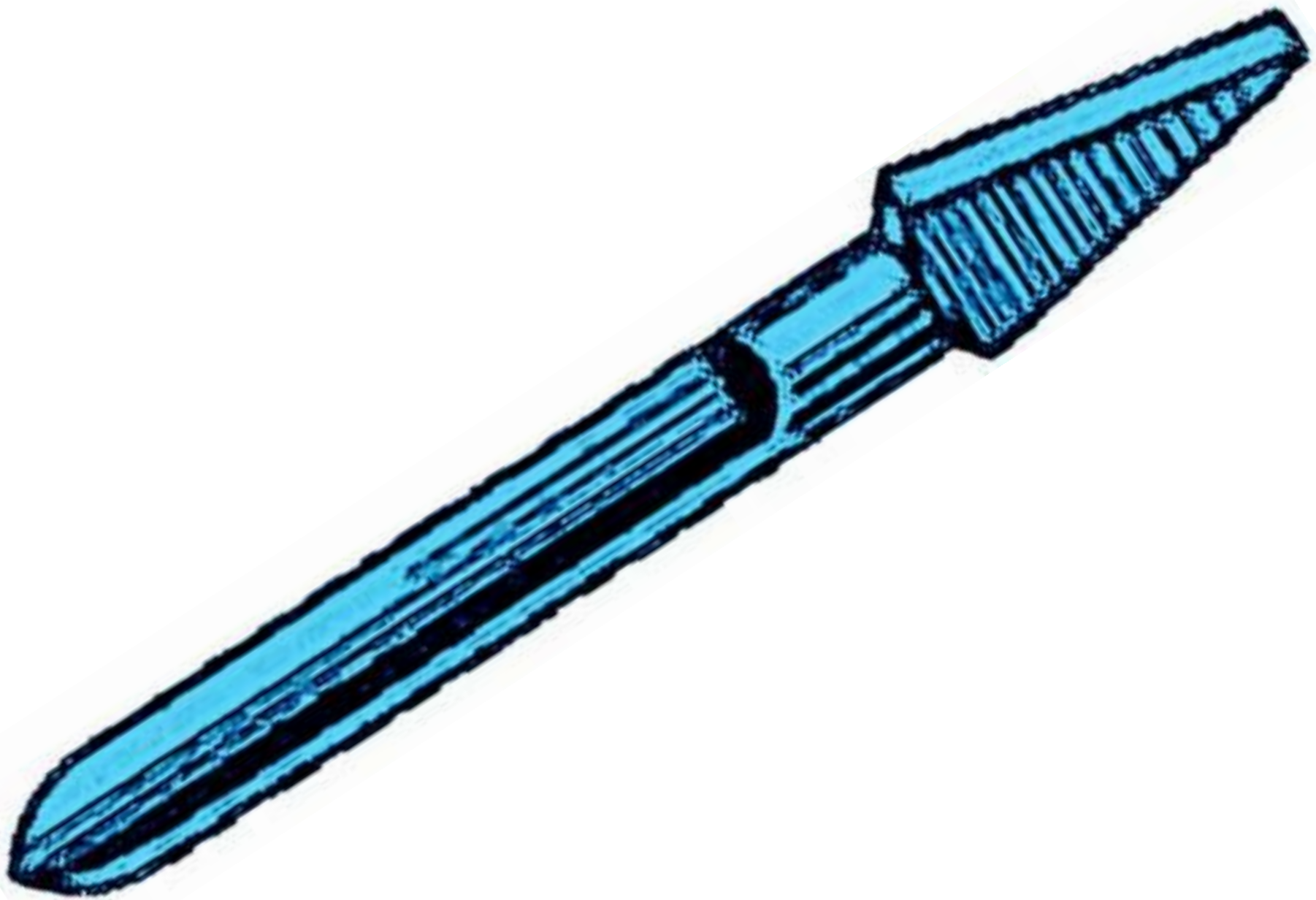

СВЕРЛО ЛОЖЕЧНОЕ



СВЕРЛО ТРИБОЧНОЕ



БУРАВЧИК



ДРЕЛЬ ЭЛЕКТРИЧЕСКАЯ



СЪ_ГЛО ПЕРОВОЕ



СВЕРЛО СПИРАЛЬНОЕ ЦЕНТРОВОЕ



СВЕРЛО СПИРАЛЬНОЕ КОНИЧЕСКОЕ



3EH.



КОЛОВОРОТ

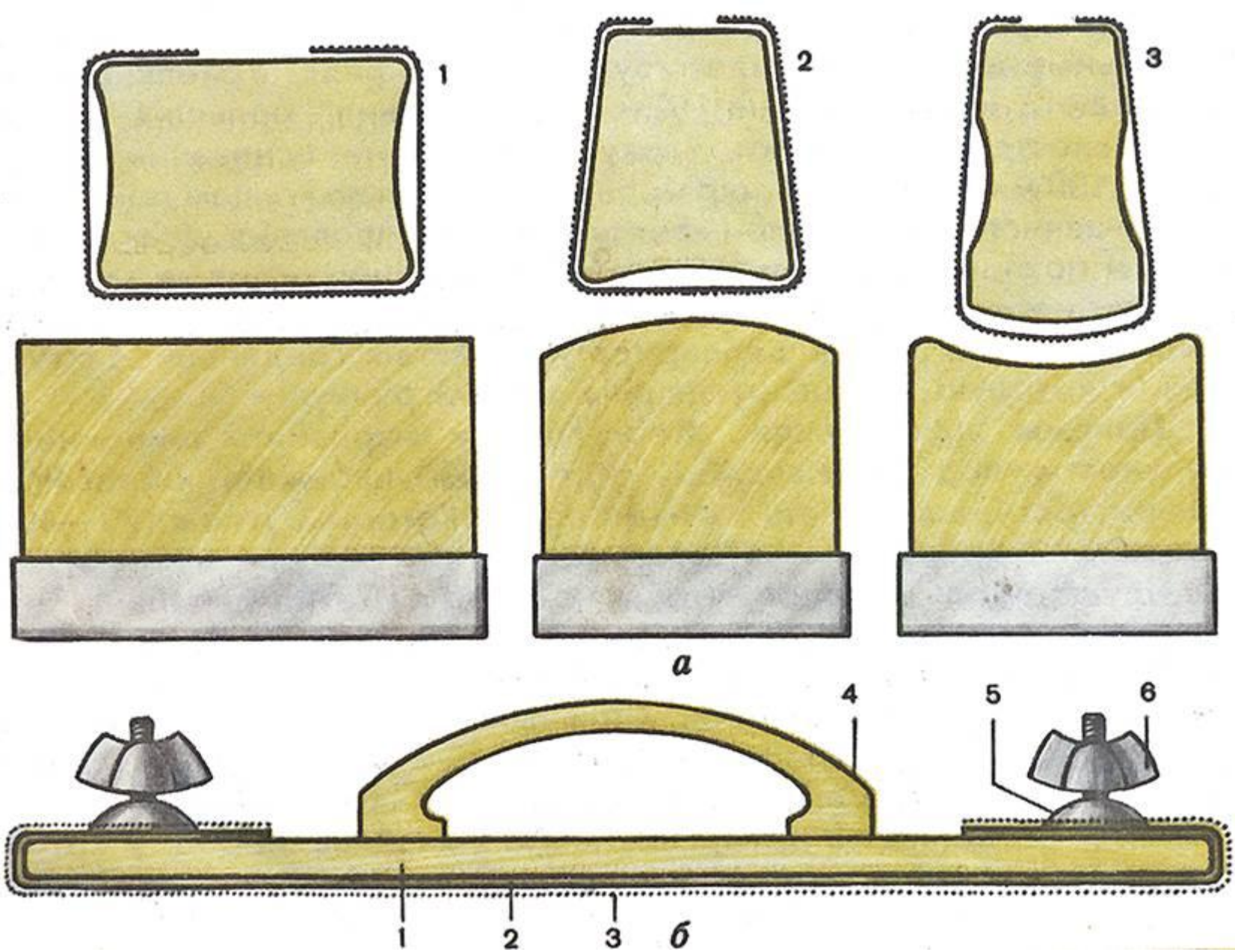

КОЛОДКИ ШЛИФОВАЛЬНЫЕ



ЛЕНТОЧНАЯ ШЛИФМАШИНА



ЭКСЦЕНТРИКОВАЯ ШЛИФМАШИНА



УГЛОВАЯ ШЛИФМАШИНА