

QUESTIONS

HOW MANY?



WHAT?



WHERE?



ESL/EFL Resources for Teachers

ES English.com

www.mes-english.com

What

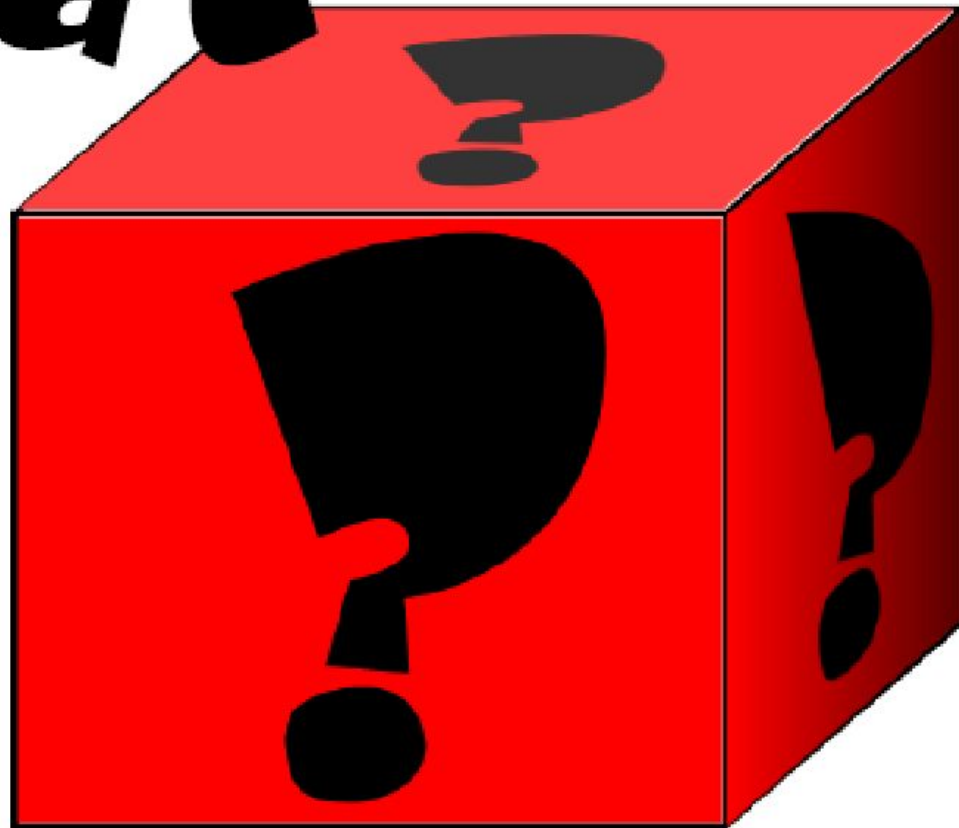

Who

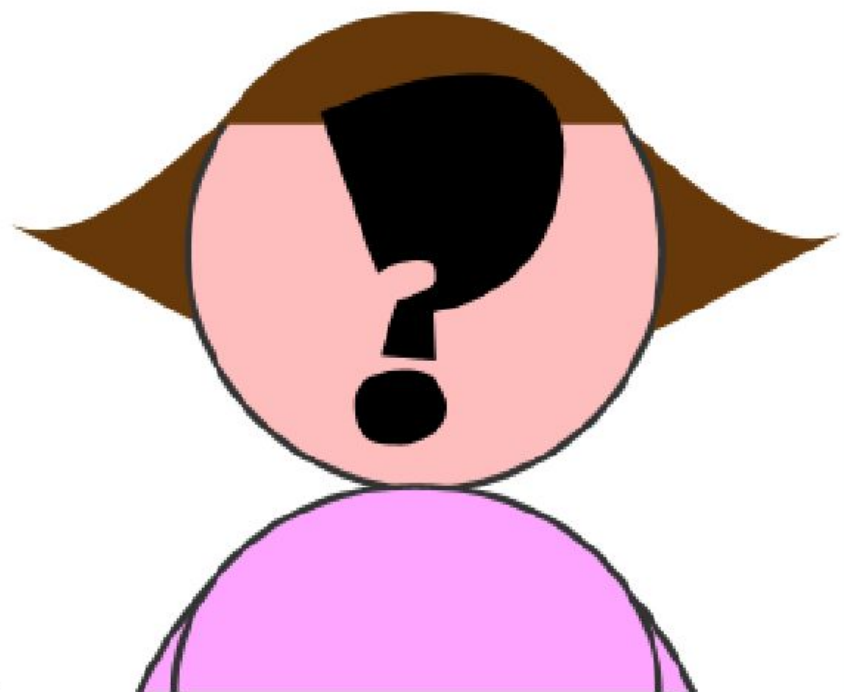
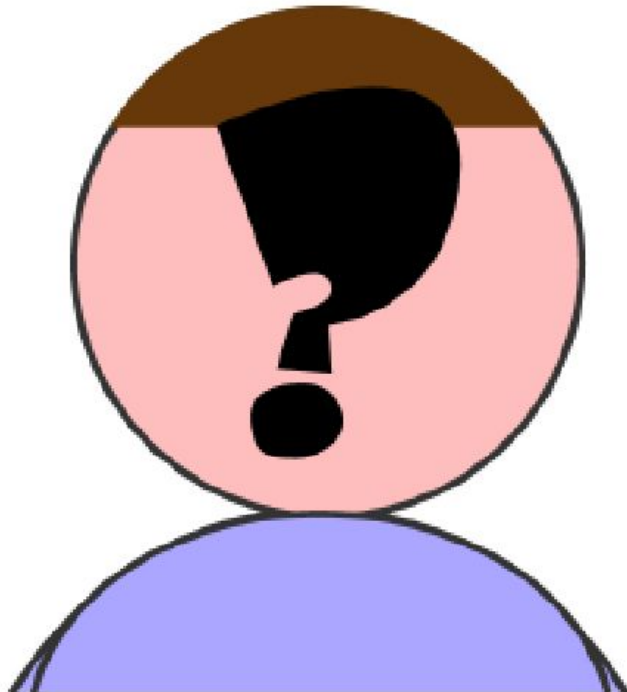

where



Which



When

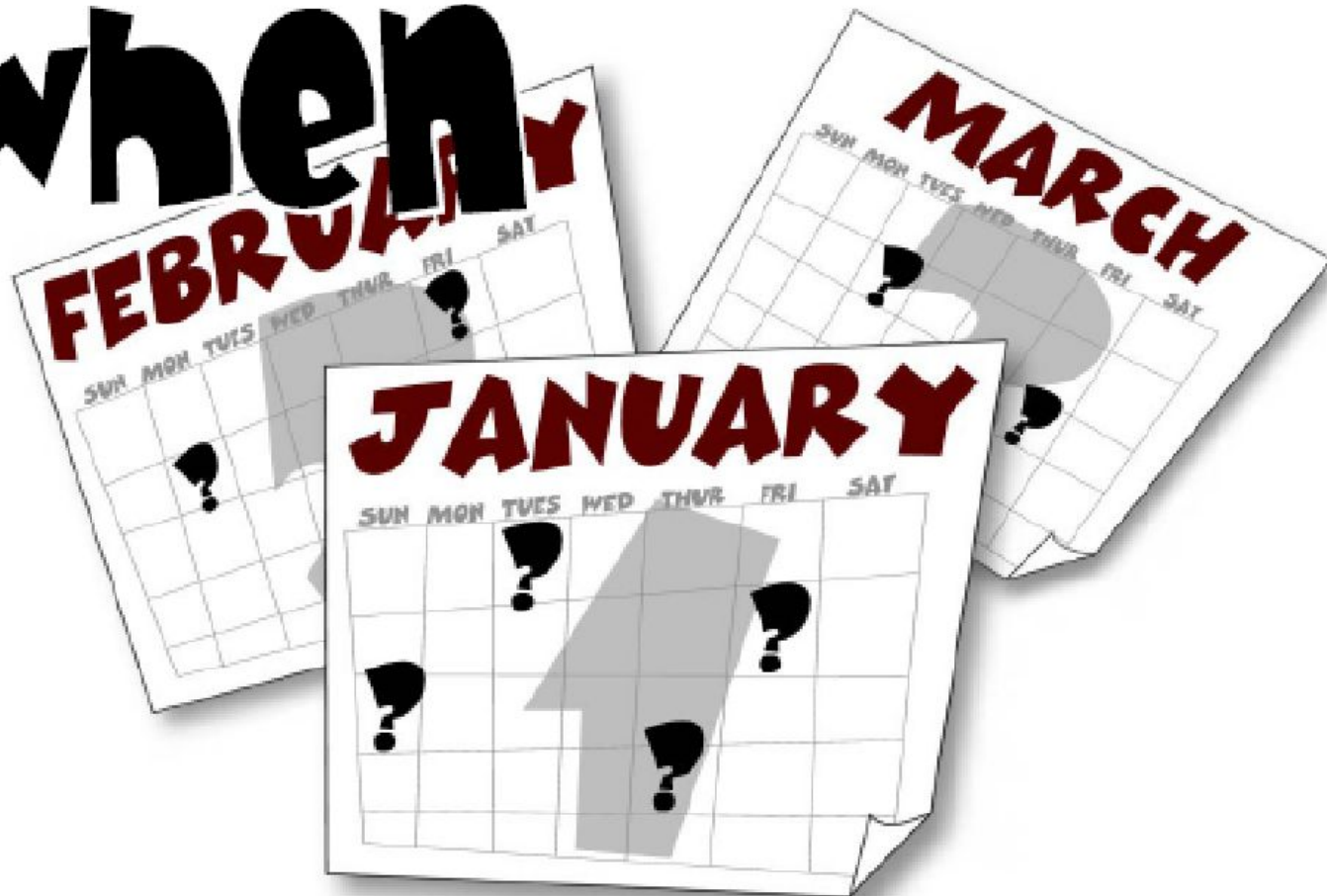

HOW MANY

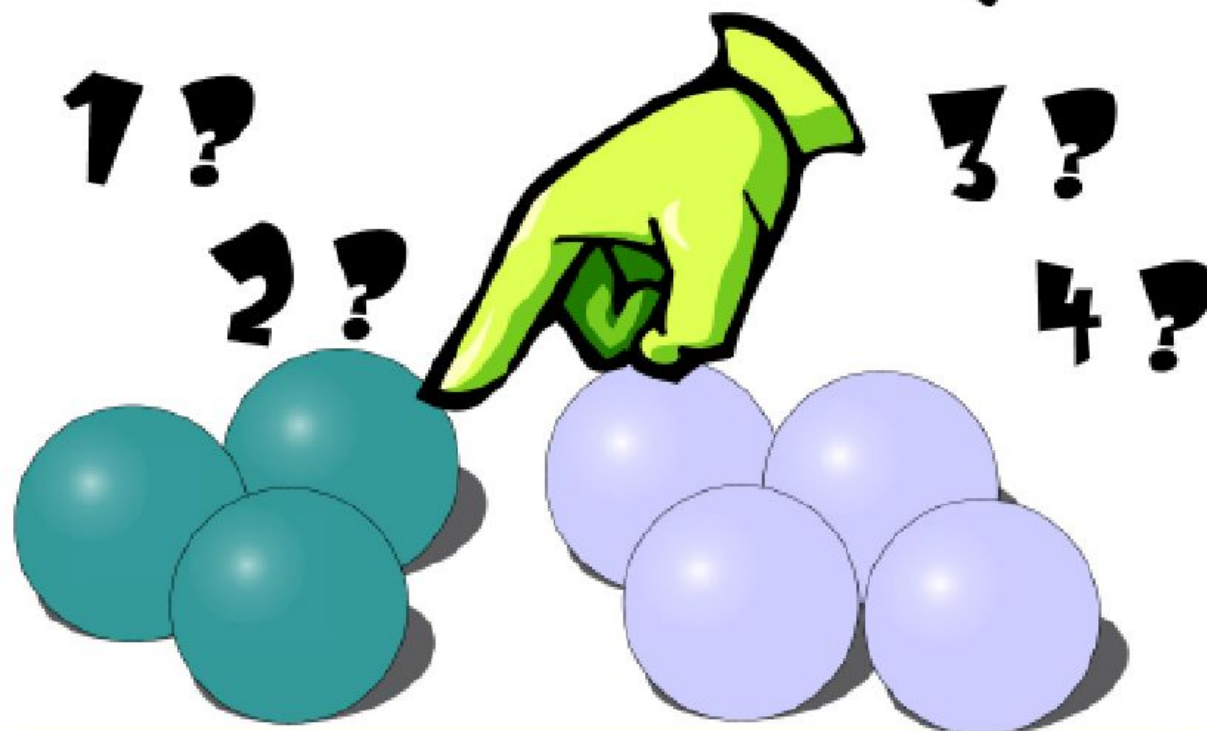

HOW MUCH

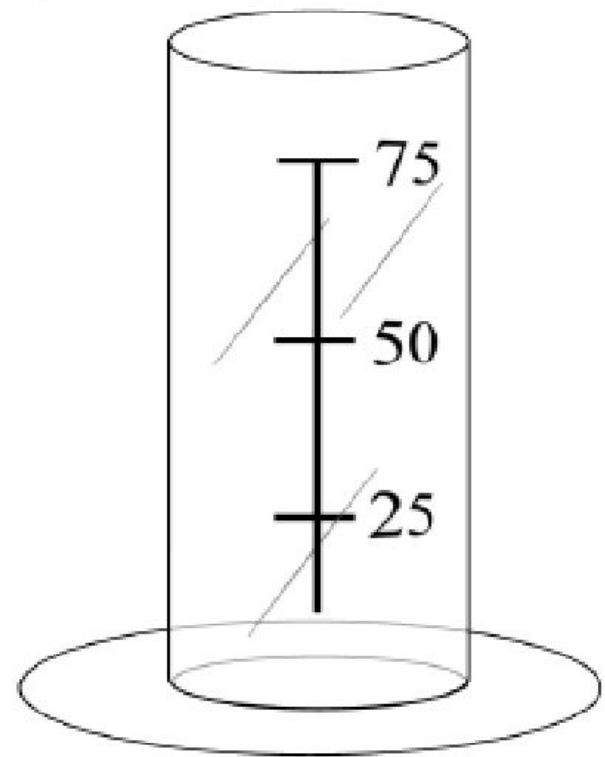
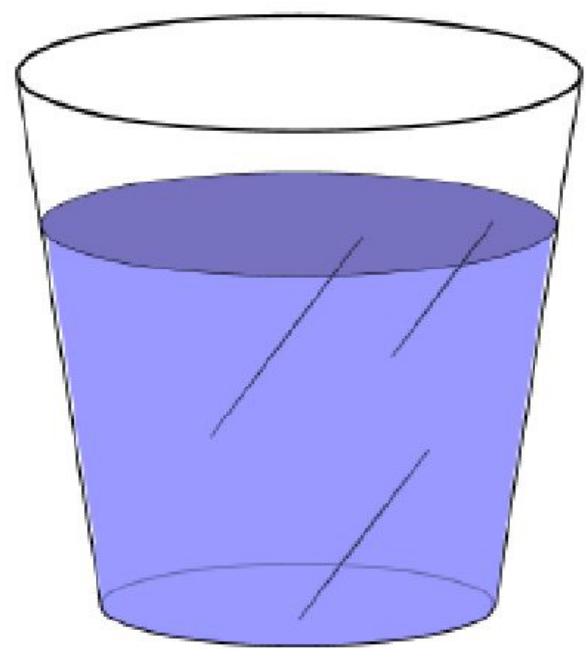

HOW MUCH



What time

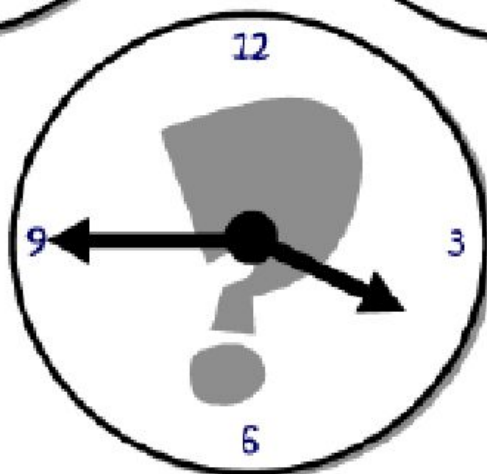
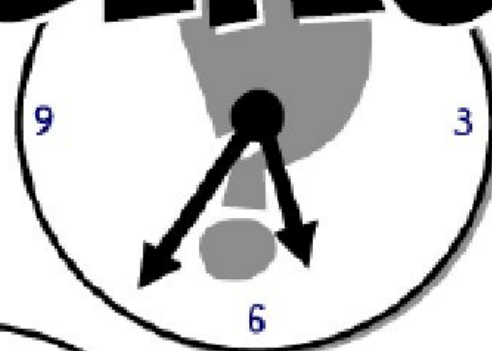
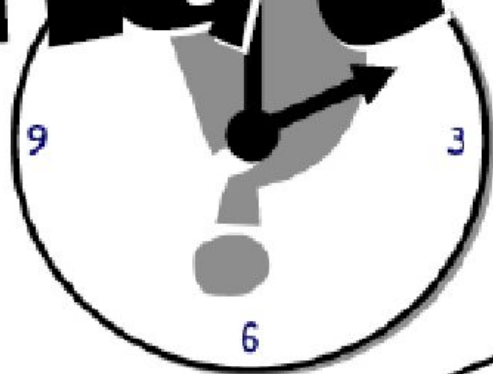



HOW LONG

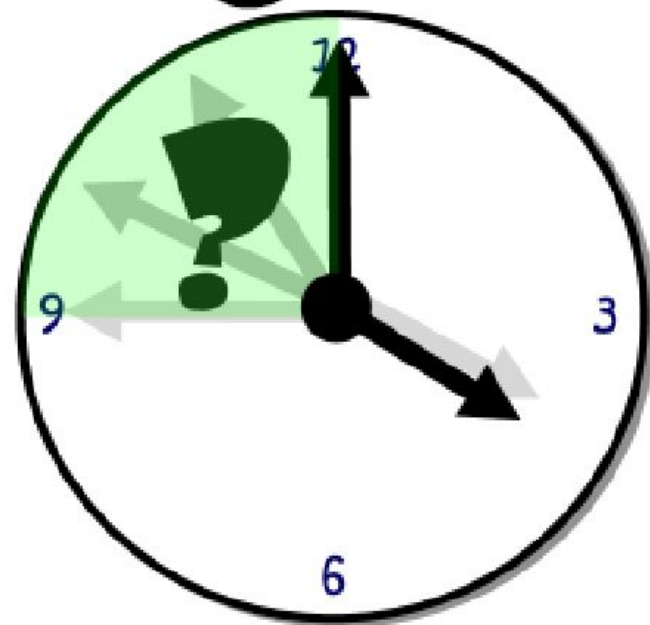

HOW LONG

