

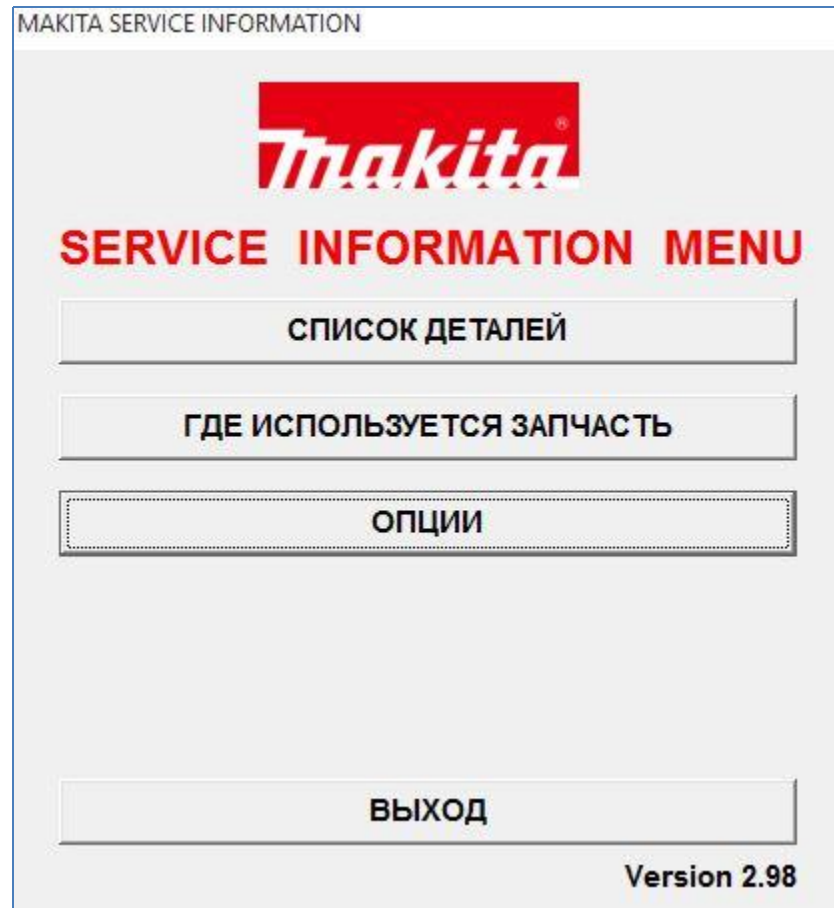

# Масла и Смазки

При проведении ремонта инструмента Makita, важно соблюдать рекомендации производителя и пользоваться сервисной Инструкцией по смазке.

Инструкция по смазке прописана в сервисной программе **MSI**.





Для того чтобы найти информацию по типу применяемой смазки в инструменте, количеству и месту смазывания – откроем сервисную программу **MSI**.

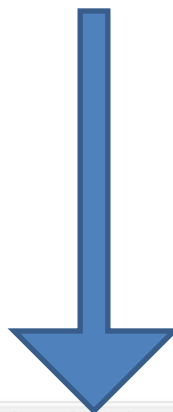
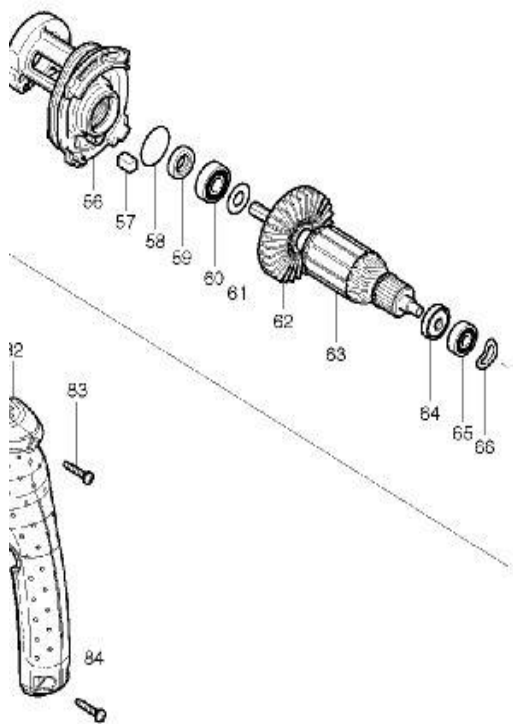



# При открытии файла, ищем **LUBRICATION**

► **Repair**

[2] **LUBRICATION** (for HR2610/ HR2611F)

Apply the following grease/ lubricant to protect parts and product from unusual abrasion.

| Item No.   | Description                                  | Portion to lubricate  | Grease/ Lubricant                 | Amount          |
|------------|--|---|-----------------------------------|-----------------|
| ①          | Cap 35                                       | Lip portion where Bit is to be inserted   |                                   |                 |
| ①⑥         | Gear housing complete                        | Oil seal 25 on the inside of Gear housing complete  |                                   |                 |
| ②①         | Push corn                                    | Portion that contacts Clutch cam A  |                                   |                 |
| ②①         | Compression spring 5                         | Periphery   |                                   | a little        |
| ②⑥         | Steel ball 7.0 (2 pcs.)                      | Entire surface  |                                   |                 |
| ②⑧         | Tool holder complete<br>(140264-5/ 140265-3) | (a) Periphery that contacts ②⑨ Driving flange / ③① Spur gear 51<br>(b) Inside where ④⑥ Piston cylinder reciprocates |                                   |                 |
| ②⑨         | Driving flange                               | Portion that contacts ③① Spur gear 51/ Pins 6 (6 pcs.)  |                                   | 2g              |
| ③②         | Flat washer 30                               | Portion that contacts ③① Spur gear 51/ Pins 6 (6 pcs.)  |                                   |                 |
| ③⑥         | Flat washer 30                               | Portion that contacts Inner housing complete  |                                   |                 |
| ③⑧         | Impact bolt A                                | Entire surface  |                                   |                 |
| HR2611F ④① | Compression spring 20                        | Outer periphery that contacts ②⑧ Tool holder complete   | Makita grease<br>RB No. 00 ◀      | a little        |
| ④②         | O ring 9                                     | Entire surface  |                                   |                 |
| ④④         | Striker                                      |   |                                   |                 |
| ④⑤         | O ring 17.5                                  |   |                                   |                 |
| ⑤①         | Spur gear 51                                 | Gear portion to engage with Spur gear 10/ ⑤⑤ Cam shaft  |                                   |                 |
| ④⑥         | Piston cylinder                              | (c) Inside where ④④ Striker moves<br>(d) Periphery that ②⑧ Tool holder complete contacts                            |                                   | 19g<br>in total |
| ④⑦         | Guide plate                                  | Inside that contacts Piston joint   |                                   |                 |
| ⑤⑤         | Cam shaft                                    | (e) Gear portion that engages ③① Spur gear 51<br>(f) Portion that contacts ⑤⑧ Swash bearing 10                      |                                   | 3g              |
| ⑤⑧         | Swash bearing 10                             | (g) Pole portion to be inserted into Piston joint<br>(h) Ball bearing portion                                       |                                   | a little        |
| ⑥④         | Helical gear 26                              | Gear portion that engages with Armature gear shaft  |                                   | 3g              |
| ⑥③         | O ring 21                                    |   |                                   |                 |
| ⑥⑤         | O-ring 68                                    | Whole portion   |                                   |                 |
| ⑦①         | O ring 26                                    |   |                                   |                 |
| ⑦①         | Oil seal 12                                  | Portion that contacts Sleeve 9  | Makita lubricating<br>oil VG100 ◀ | a little        |



В таблице указывается нумерация смазываемых позиций и тип применяемой смазки.

У каждого типа смазки и пропорции поставки - есть свой артикул. Для удобства поиска артикула – есть **таблица**.

|                                      |                   |  |   |
|--------------------------------------|-------------------|--|---|
|                                      |                   | Смазка для редуктора (Эл.лобзика, акк. инструмент)     | 4 |
| 042025-8A                            | Grease FA №2      |  | E |
|                                      |                   |  | E |
|                                      |                   |  | T |
| 042040-2A - 500 gr (181490-7 - 30gr) | Grease R №00      | Смазка для редуктора (Отбойные молотки, перфораторы)   | E |
| (042009-6A - 500gr.)                 |                   |  | F |
| 042018-5A                            | Grease R №1       | Смазка для редуктора (Ударные дрели, акк. перфораторы) | E |
| 183477-5(30gr)                       | Grease RA №1      | Смазка для поршневой системы перфораторов              | F |
| 042024-0A(2,5kg)                     |                   |  | E |
| 195127-0(30gr)                       | Grease RB №00     | Смазка для редуктора (Аккумуляторные перфораторы)      | E |
| 042016-3A                            | Grease SG №0      | Смазка для редуктора (Ушм)                             | 4 |
|                                      |                   |  | G |
|                                      | Grease SG №00     |  | L |
|                                      | Grease SG №1      |  | G |
| 042011-9A                            | Isoflex NB52      | (Пневмоинструменты, акк. инструменты)                  | E |
| 042019-3A                            | Molybdenum grease | (Углошлифовальные машины, акк. перфораторы)            | E |
|                                      |                   |  | 2 |
| 196804-7                             | Смазка            | Смазка для хвостовиков буров                           | G |
|                                      |                   |  | E |
|                                      |                   |  | T |



**Makita**  
working world  
wide

## OIL

| USE                                      | TYPE   | PART NO. | QUANTITY |
|--|--|----------|----------|
| AS LUBRICANT FOR RUBBING SURFACE *       | MACHINE OIL #120 (C MACHINE OIL)               | 182056-6 | 100cc    |
|  |  | 182470-6 | 30cc     |
| FOR HAMMERS WITHOUT GREASE PACKED SYSTEM | MAKITA HAMMER OIL XLD (HD SUPER HPO MOTOR OIL) | 181118-7 | 100cc    |
|  |  | 181343-0 | 20cc     |

## GREASE

| USE  | TYPE                   | PART NO.  | QUANTITY |
|--|------------------------|-----------|----------|
| GENERAL USE FOR DC TOOLS                     | MAKITA GREASE N NO.2   | 042005-4A | 16.0kg   |
|  |                        | 042005-4  | 12.0kg   |
|  |                        | 181573-3  | 100g     |
| GENERAL USE FOR DC TOOLS                     | MAKITA GREASE N NO.1   | 042017-7A | 2.5kg    |
| FOR BEVEL GEAR OF GRINDERS AND CIRCULAR SAWS | MAKITA GREASE SG NO. 0 | 042016-9A | 500g     |
|  |                        | 042016-9B | 15kg     |
| FOR GREASE PACKED HAMMERS **                 | MAKITA GREASE R NO. 00 | 042009-6A | 500g     |
|  |                        | 181490-7  | 30g      |
| FOR MODEL HR2410 & HR160D                    | MAKITA GREASE R NO. 1  | 182749-5  | 30g      |
| FOR MODELS HR2440 & HR2450                   | MAKITA GREASE RA NO.1  | 042024-0A | 2.5KG    |
|  |                        | 183477-5  | 30g      |
|  | MAKITA GREASE FA NO.2  | 042025-8A | 2.5KG    |
| FOR GRINDERS WITH SJS SYSTEM                 | MOLYBDENUM GREASE      | 042019-3A | 500g     |
| FOR MODEL HR2470,HR2460,HR2470T              | MAKITA GREASE RB No.00 | 195127-0  | 30g      |

**\*THE GENUINE GREASE ARE RECOMMENDED STRONGLY**



**Makita**  
working world  
wide

# EE71000036 Масло для DBM230





**Makita**  
working world  
wide

SC00000106

Смазка для ножниц по  
металлу (35ml)





042016-9B

Смазка для редуктора SG NO.0  
(15Kg)

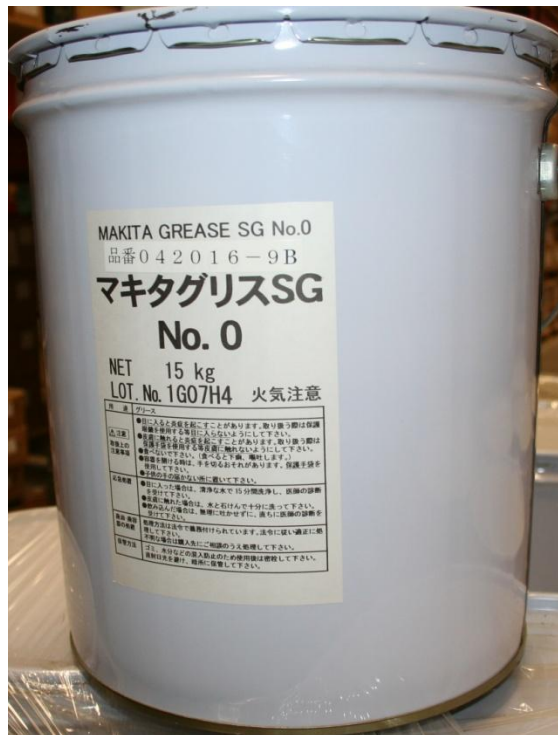





042005-4A

Смазка для редуктора N NO.2  
(16Kg)





# 194659-4

## Смазка для хвостовика бура (100ml)





196804-7

Смазка для хвостовика бура  
(95ml)



# 181573-3

## Смазка для хвостовика бура (100ml)





042016-9A / 042016-9C

Смазка для редуктора SG NO.0  
(500g)



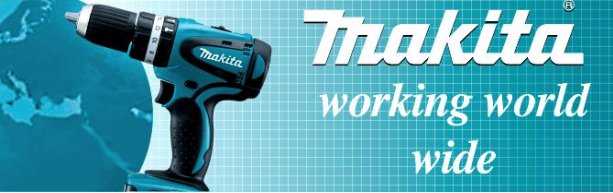

042040-2A / 042009-6A /

042040-2B

Смазка для редуктора R NO.00  
(500g)





**P-08361**

# Смазка для перфораторов и отбойных молотков



188088-1

Смазка для редуктора FA NO.2  
(30g)







181490-7 / 183D90-3

Смазка для редуктора R NO.00  
(30g)



182749-5

Смазка для редуктора R NO.1  
(30 g)



183477-5

Смазка для поршневой системы  
перфораторов RA NO.1 (30g)

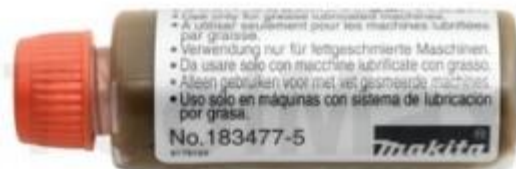



195127-0

Смазка для редуктора RV NO.00(30g)

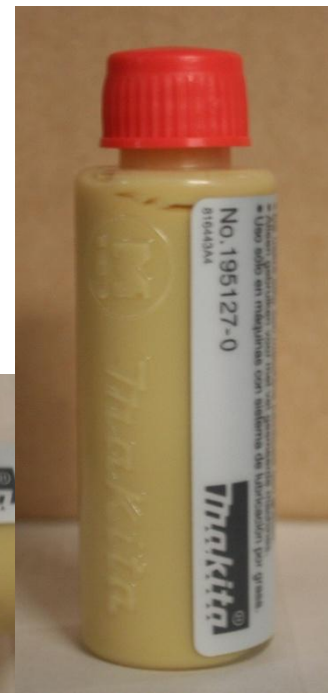
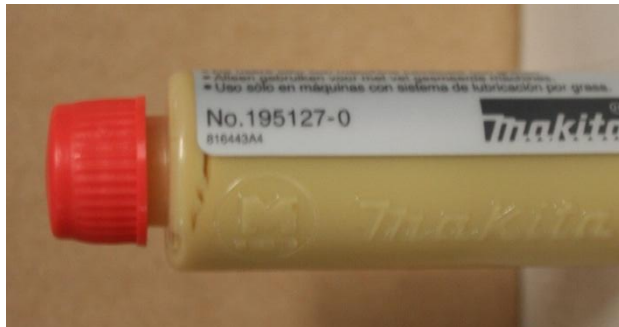



042017-7A / 042025-8A

Смазка для редуктора FA NO.2  
(2.5Kg)



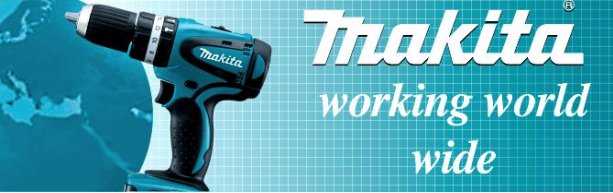

042025-8A / 042025-8B

Смазка для редуктора FA NO.2 (2.5kg)





042024-0A / 042024-0B

Смазка для поршневой системы  
перфораторов RA NO.1 (2.5kg)





191897-9

# Смазка восковая для ленточных и маятниковых пил







980408620

Масло моторное для 4х тактного двигателя (0,6L)





980408607

Масло моторное для 2х  
тактного двигателя (1L)





980408612

# Масло для 2х тактного двигателя в измерительной канистре (1L)





980408606

Масло для 2х тактного двигателя (0,1L)





988402656

Масло для цепи (1L)





980408610

Масло для цепи BioTop (1L)





980007101

Паста силиконовая (90ml)





944360000

Универсальная смазка (50ml)







980009055

# Фиксатор валов и втулок Loctite 620 (50ml)





980009000

Фиксатор резьбы средней прочности  
(10ml)





980009065

Анаэробным герметик средней  
прочности (50ml)





**Makita**<sup>®</sup>  
*working world  
wide*

Мы благодарим Вас за  
выбор оригинальной  
смазки Makita