

Concepts of multilevel parking lots in Vinnytsia

- 06.08.2018
- E. Walas

Location map

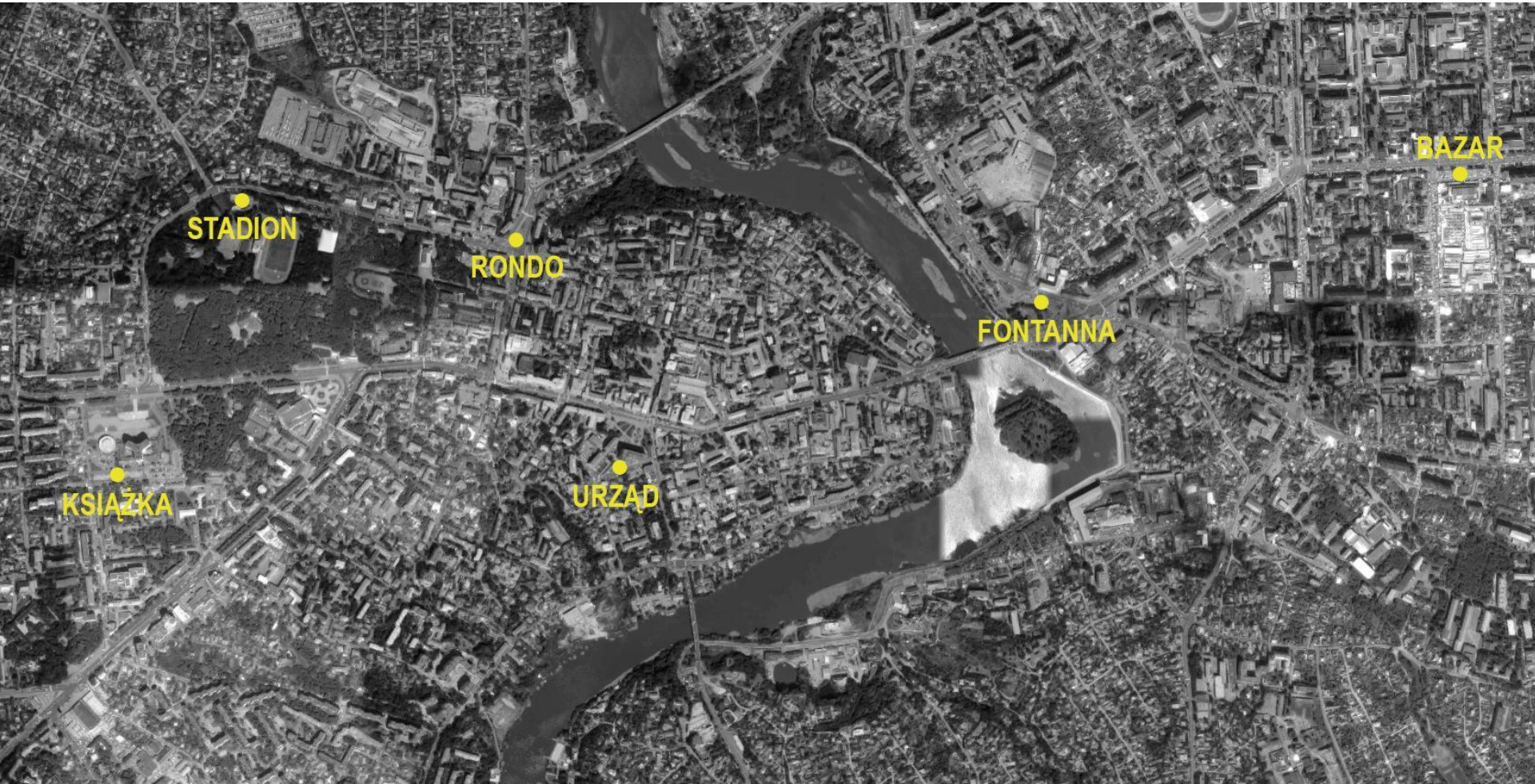

FONTANNA – current view

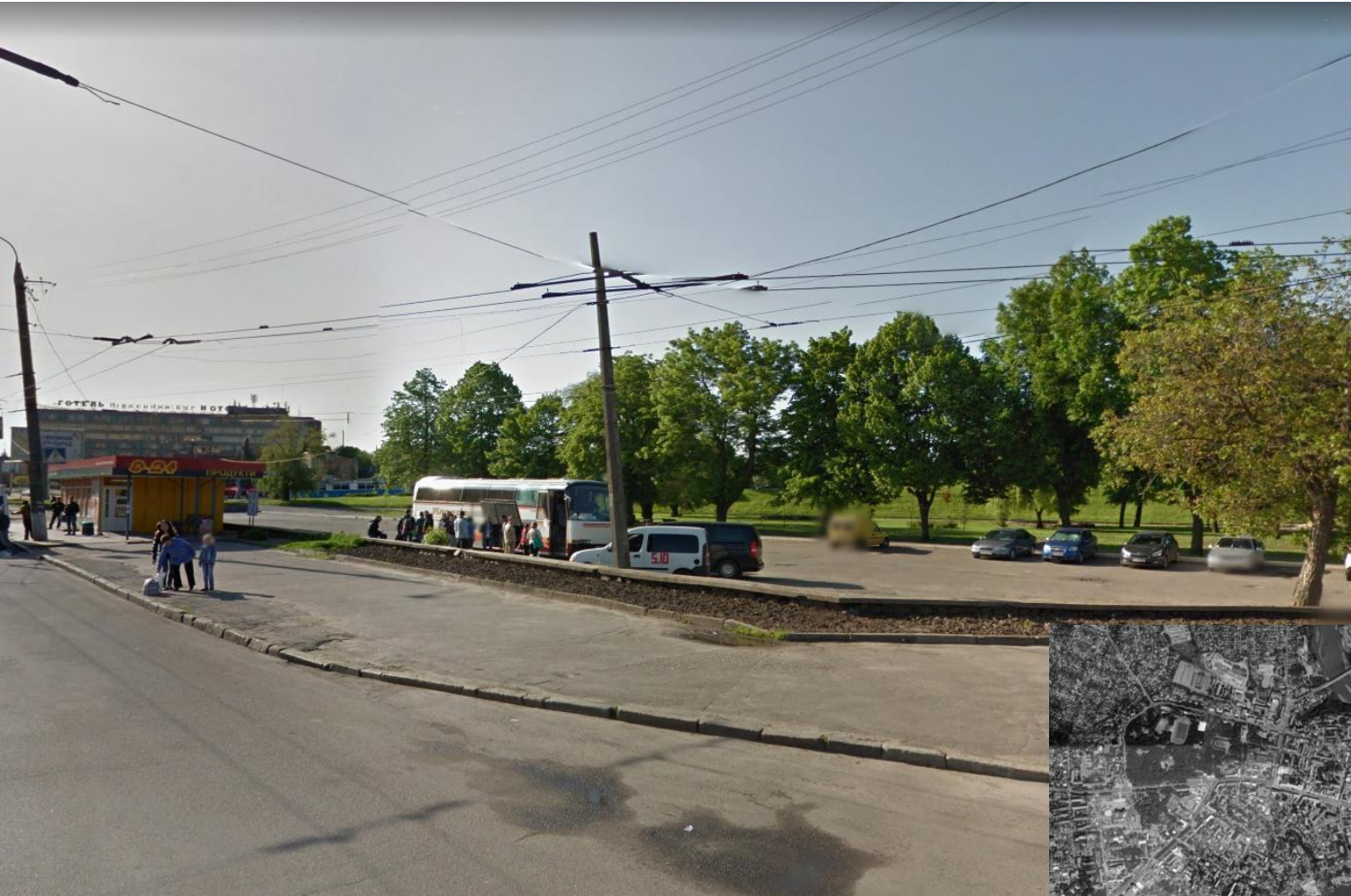

FONTANNA - concept

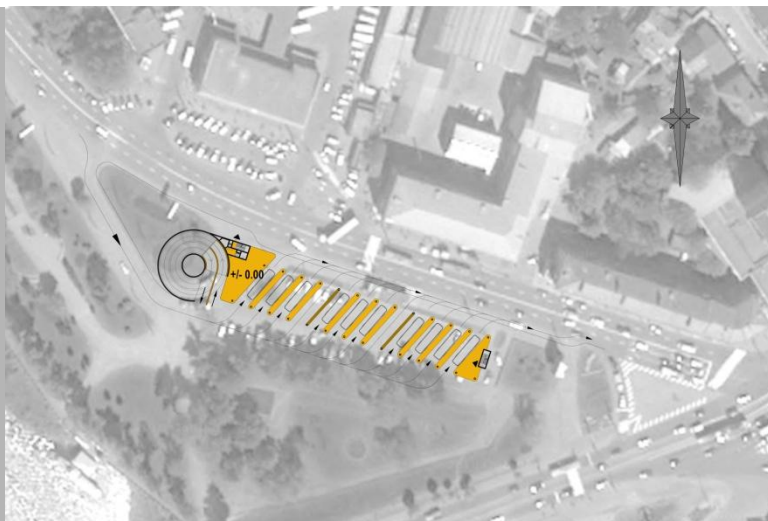

LAND USE PLAN

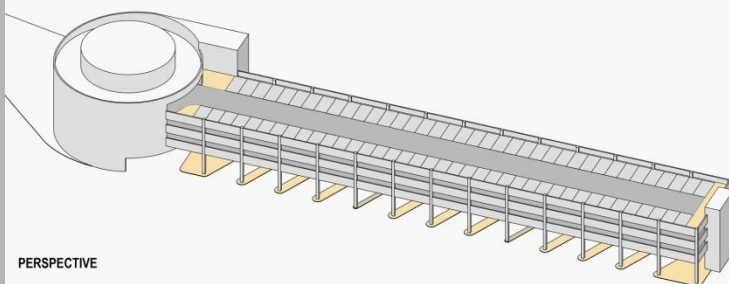

PERSPECTIVE

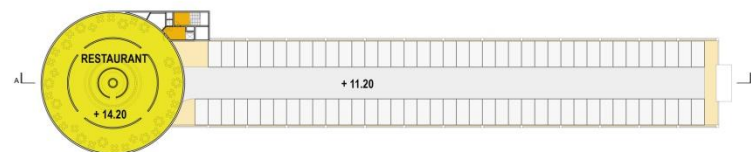

LEVEL 4

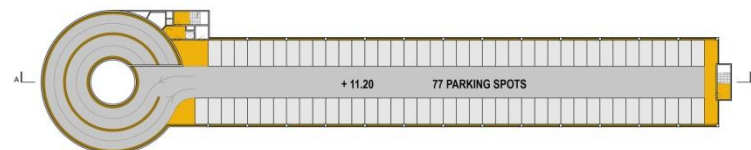

LEVEL 3

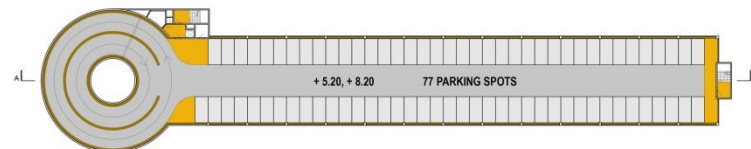

LEVEL 1-2



LEVEL 0

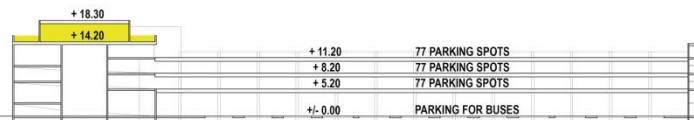

SECTION A-A 231 PARKING SPOTS

FONTANNA – concept – variant 2

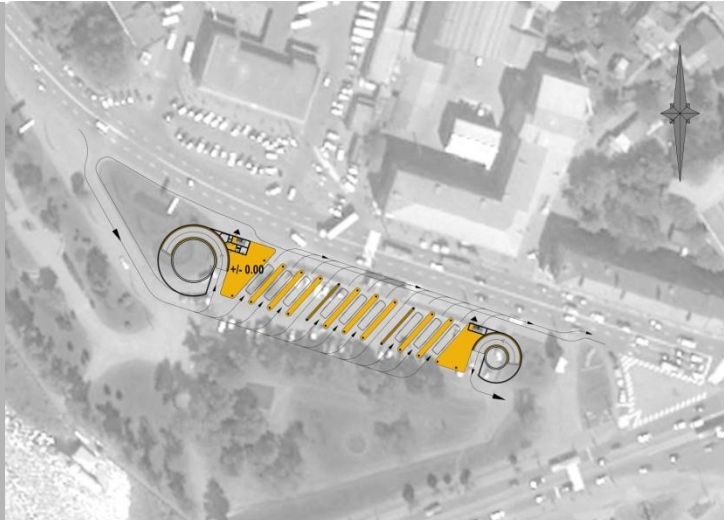

LAND USE PLAN

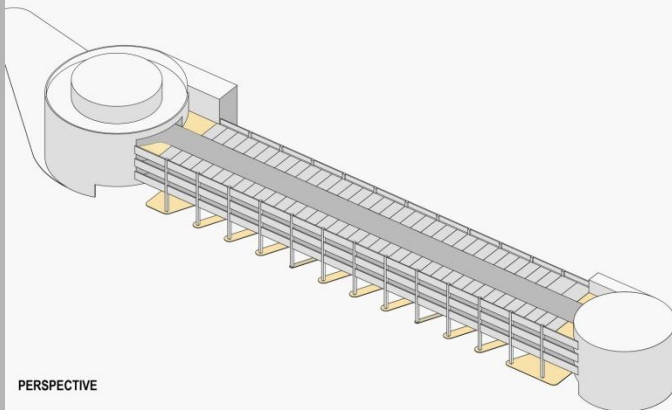

PERSPECTIVE

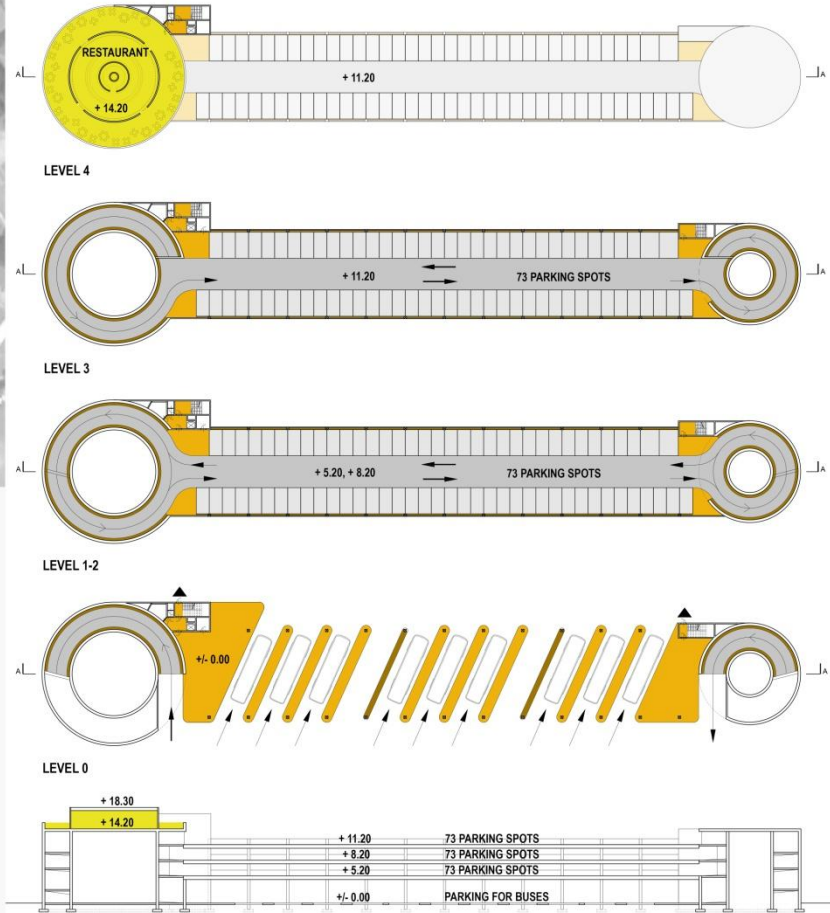

KSIAŻKA - current view



KSIĄŻKA - concept



LAND USE PLAN

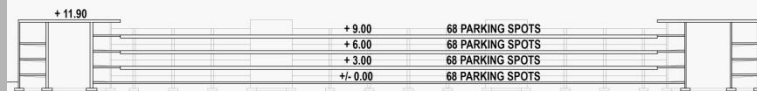

SECTION A-A 272 PARKING SPOTS

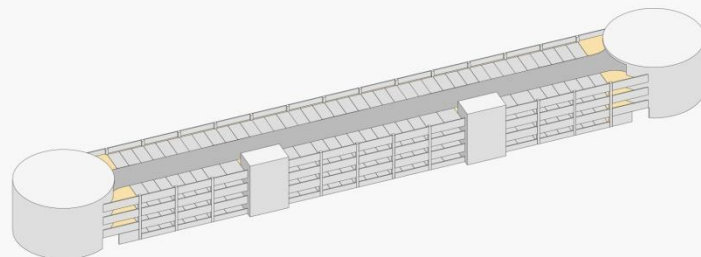

PERSPECTIVE

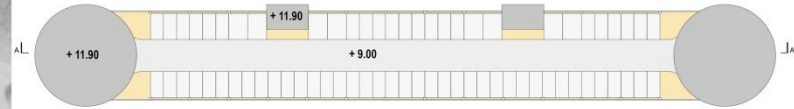

ROOF LEVEL

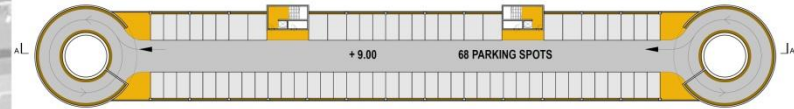

LEVEL 3



LEVEL 1-2

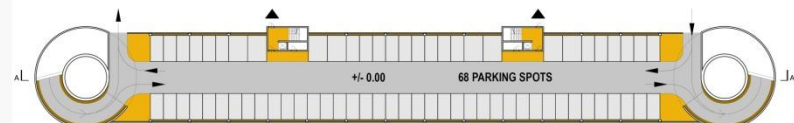

LEVEL 0



STADION - current view



STADION - concept

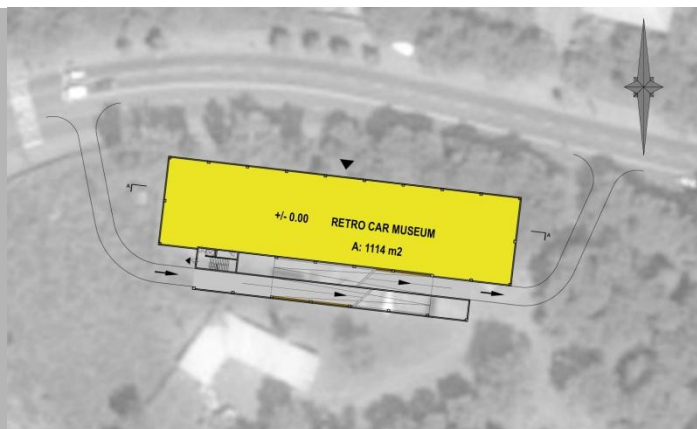

LEVEL 0

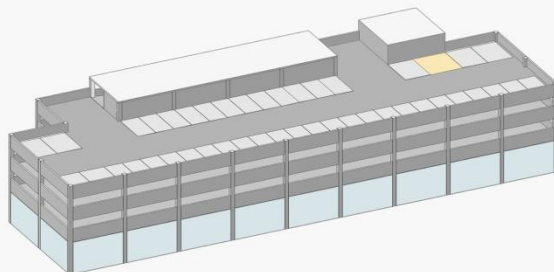
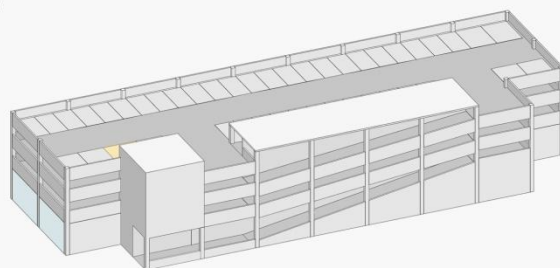

PERSPECTIVES

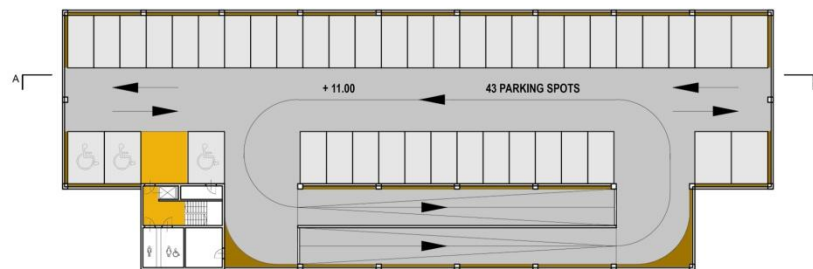

LEVEL 3

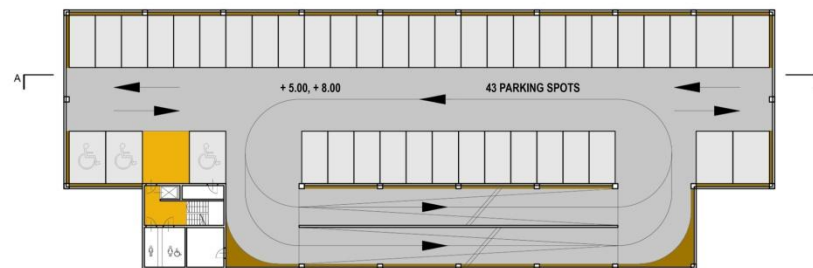

LEVEL 1-2

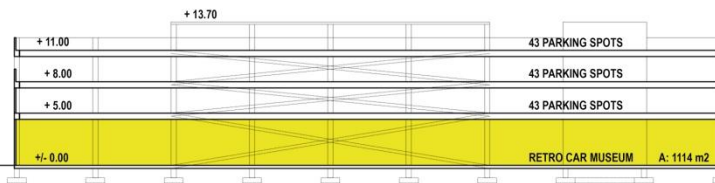

SECTION A-A 129 PARKING SPOTS



URZAÐ - current view



URZAÐ - concept



LEVEL 0



SECTION A-A

176 PARKING SPOTS

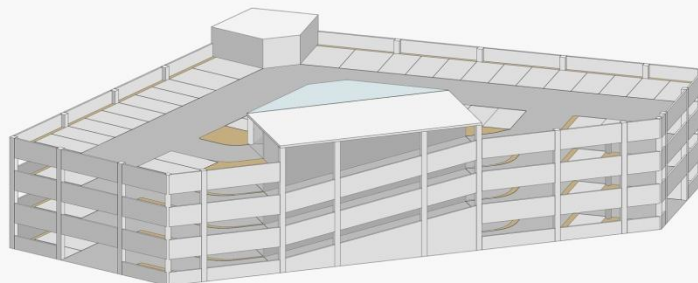

PERSPECTIVE

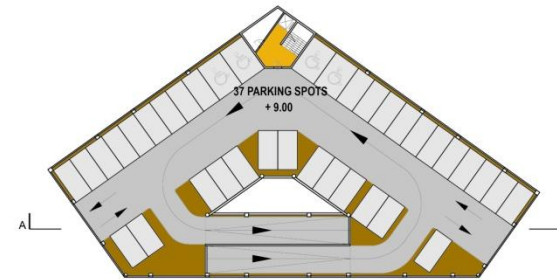

LEVEL 3

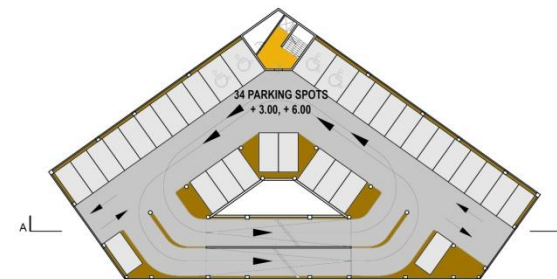

LEVEL 1-2

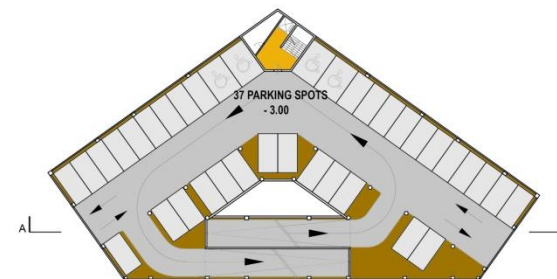

LEVEL -1

RONDO - current view



RONDO - concept



LEVEL 0

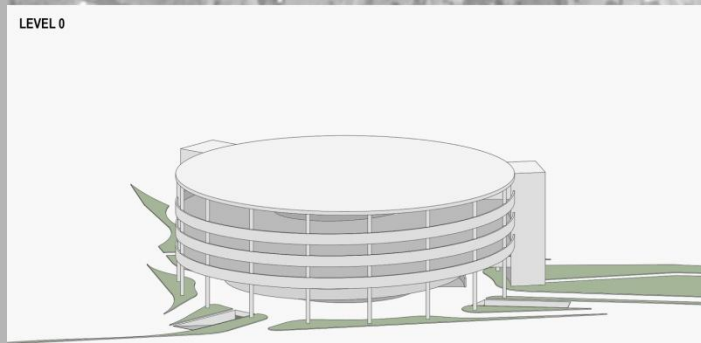

PERSPECTIVE

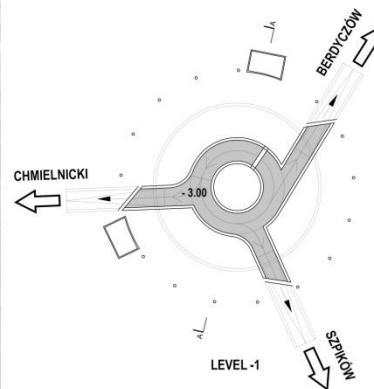

LEVEL -1

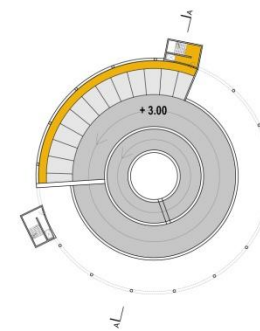

LEVEL 1

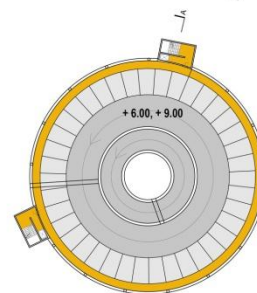

LEVEL 2-3

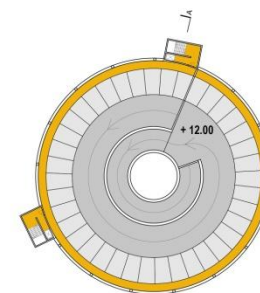

LEVEL 4



SECTION A-A
117 PARKING SPOTS

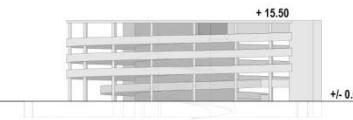

SIDE VIEW



BAZAR - current view



BAZAR - concept

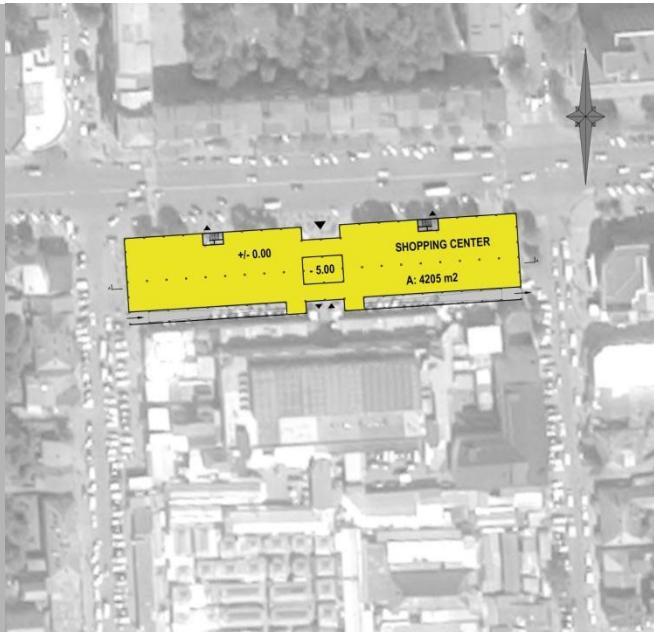

LEVEL 0

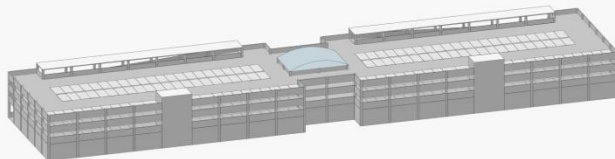
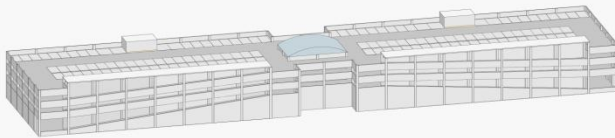

PERSPECTIVE

BAZAR

CONCEPT OF THE PARKING GARAGE IN VINNITSA; MAY, 2018; PREPARE: MGR INŻ. ARCH. EWELINA WALAS

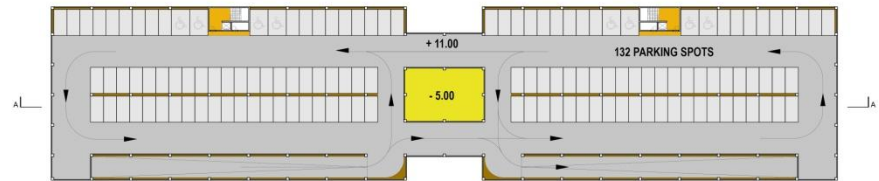

LEVEL 3

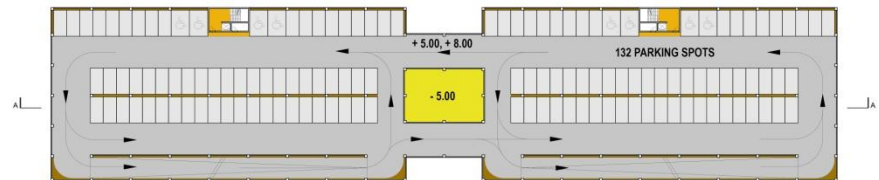

LEVEL 1-2

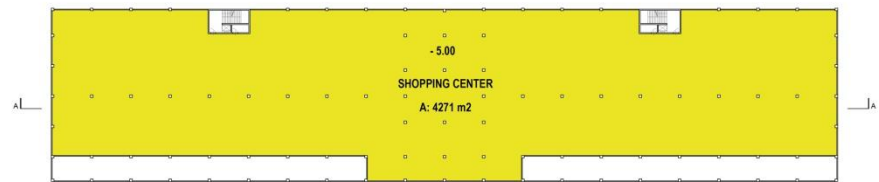

LEVEL -1

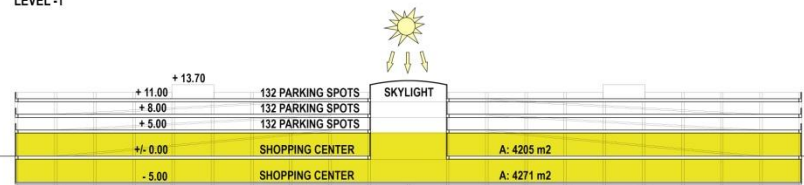

SECTION A-A 396 PARKING SPOTS

