

# MTG

No limits innovation

PROMET

ProMet: innovative hammerless system for bucket protection

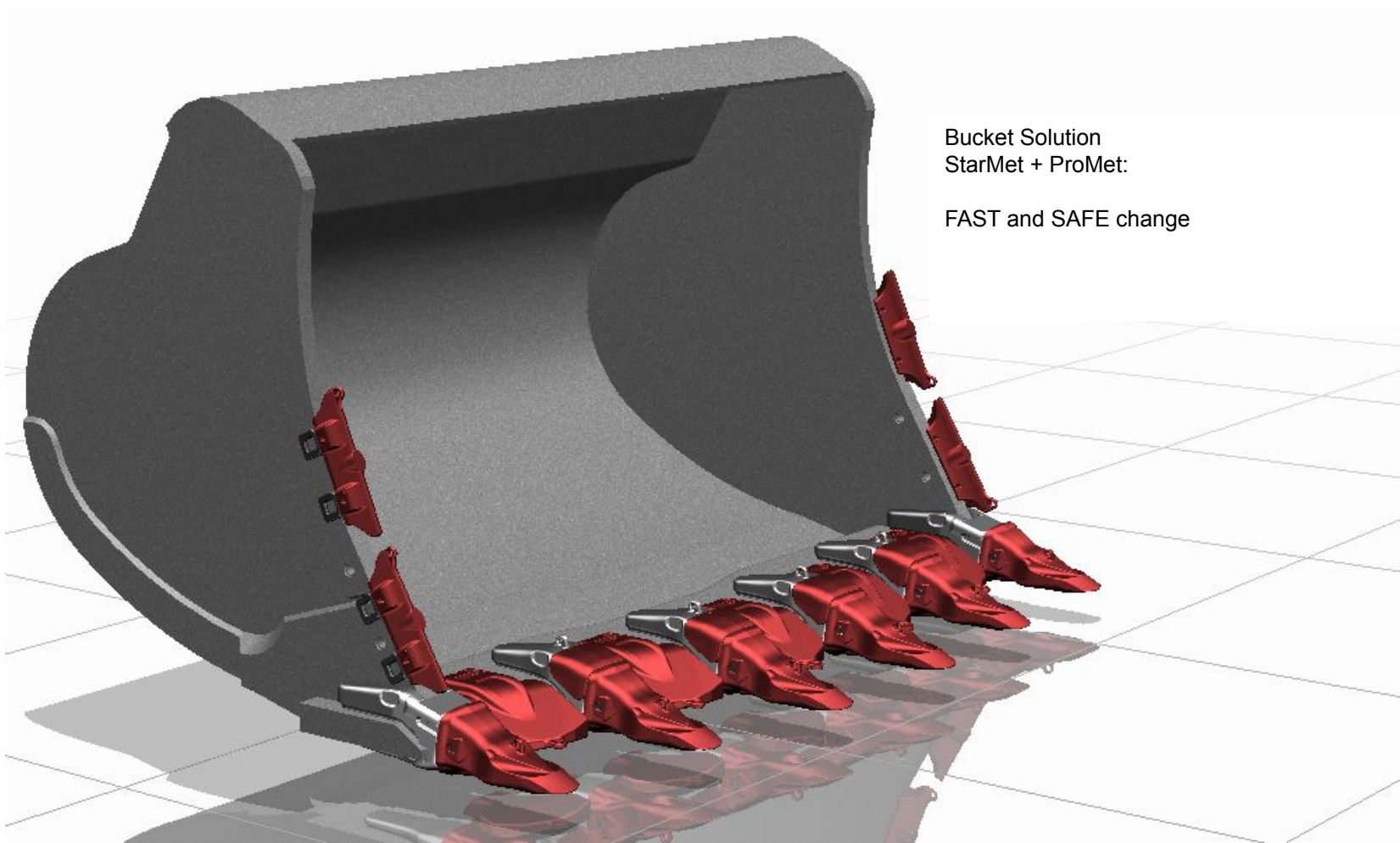

Bucket Solution  
StarMet + ProMet:

FAST and SAFE change

# System components

## MTG Systems ProMet

Uses **MTGtwist**, the innovative hammerless solution

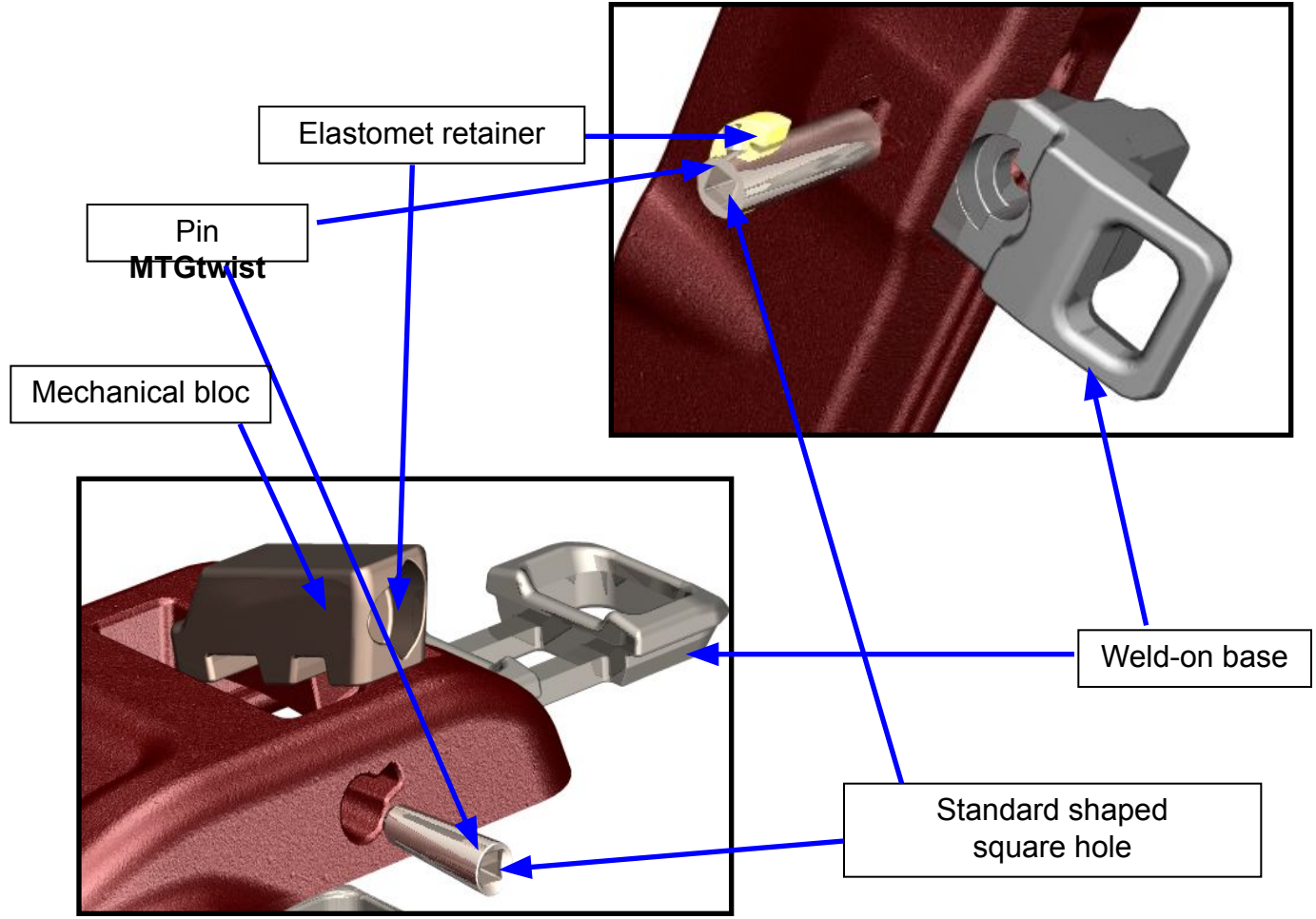

# ADVANTAGES

- Fast and Safe change
- Reduced machine downtimes
- Extend bucket life
- Enlarge bucket capacity and penetration
- Longer Shrouds wear life

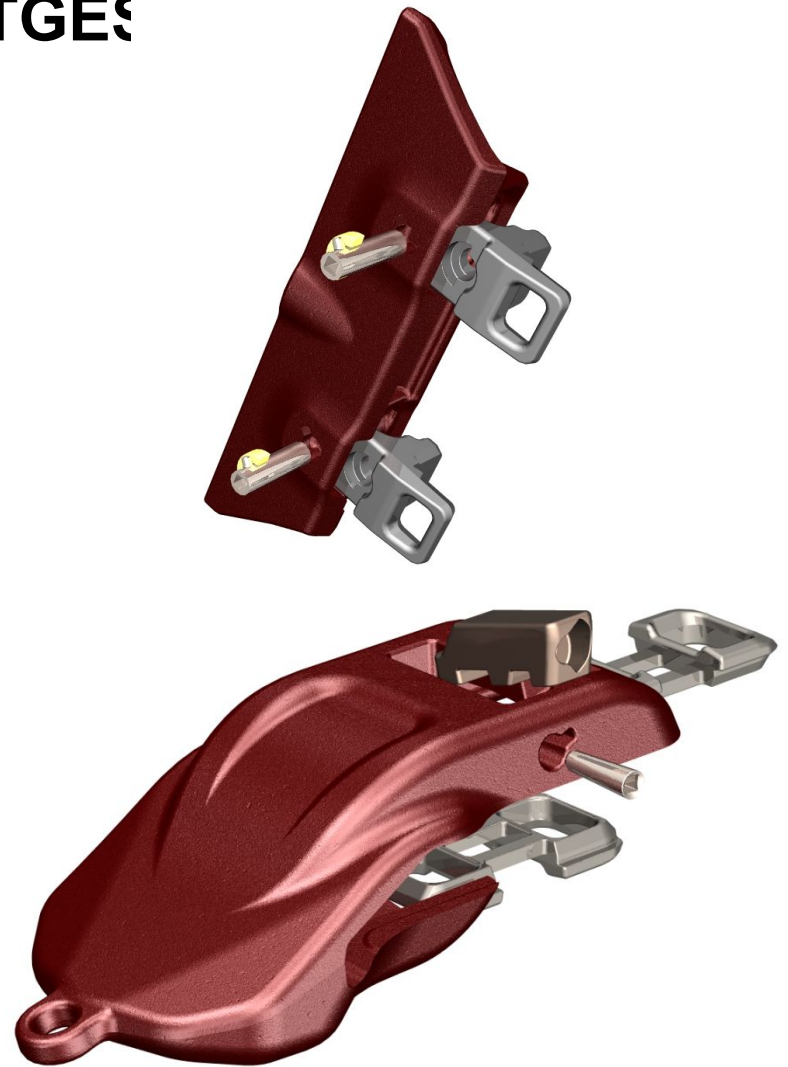

# FAST AND SAFE CHANGE

Lateral ProMet change



Lip ProMet change

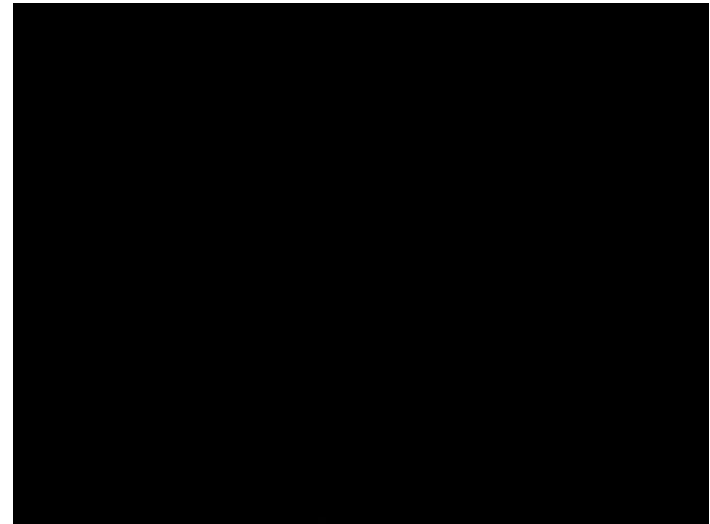

- **Reduces machine downtimes**
- **No hammer, no accidents**

# FAST AND SAFE CHANGE

**MTGtwist** offers in the change of teeth:

- Safety:** no hammer, no accidents.
- Comfort:** Less effort required. Just turn the pin.
- Reduced cost:** no need for two people.
- Quick change:** machine with less time stopped.

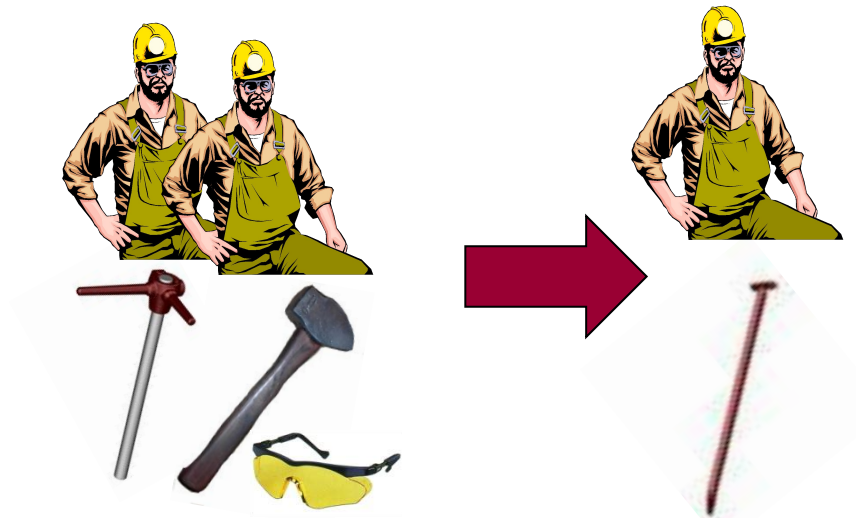



# EXTEND BUCKET LIFE

Extend the lip life



Extend the lateral plate life



Protect the adapter weldings



Reduces the bucket maintenance

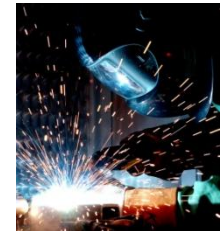

# ENLARGE BUCKET CAPACITY AND PENETRATION

**More material into  
bucket**

Increased productivity





# LONGER SHROUDS WEAR LIFE

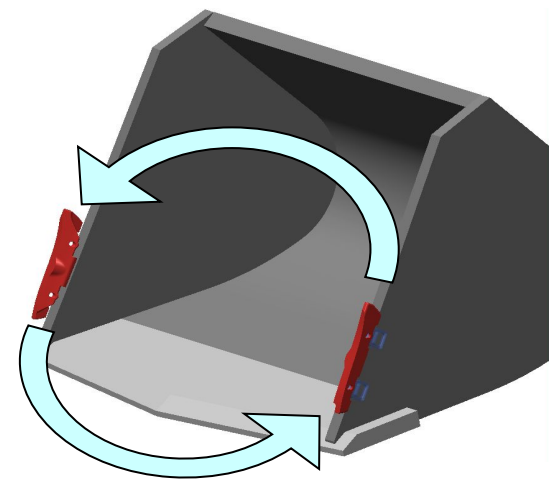
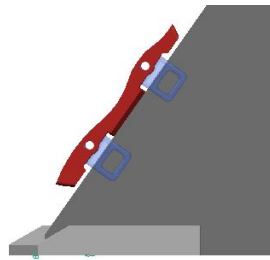
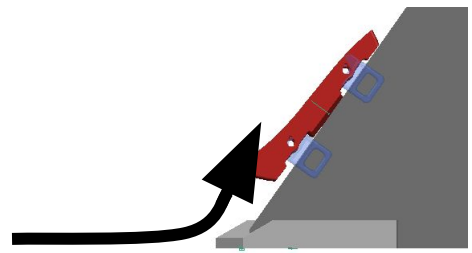
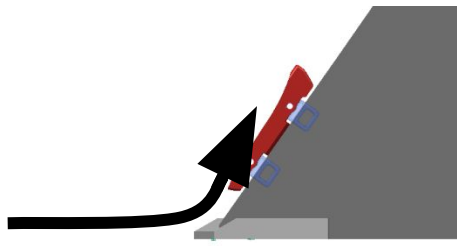
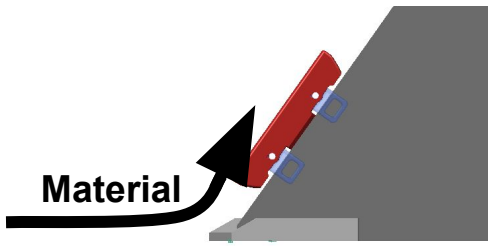

- ProMet lateral is**
- Reversible
  - Self-sharpening.

# LONGER SHROUDS WEAR LIFE

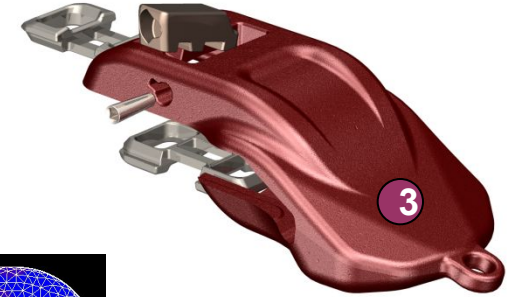
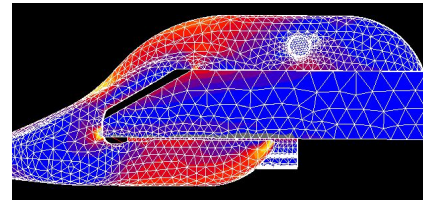
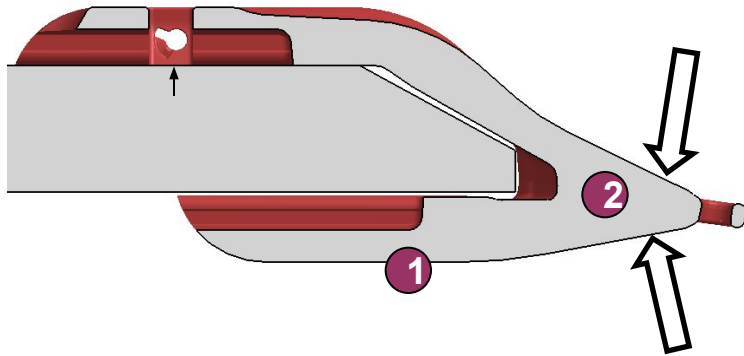

## 1. Lip ProMet more resistant to impacts

Double legs increase the resistance and durability

## 2. Lip ProMet with more wear material

longer wear life

More material in the bottom leg to protect the adapter weldings

## 3. Lip ProMet with self-sharpening design

# GREATER BUCKET PROTECTION

**PROMET PROTECTS THE BUCKET AND IMPROVES PRODUCTIVITY IN THE SAFEST WAY.**

- Easy instalation
- Fast and safe change
- Less machine downtimes
- Extend the bucket life
- Increase bucket capacity and penetration

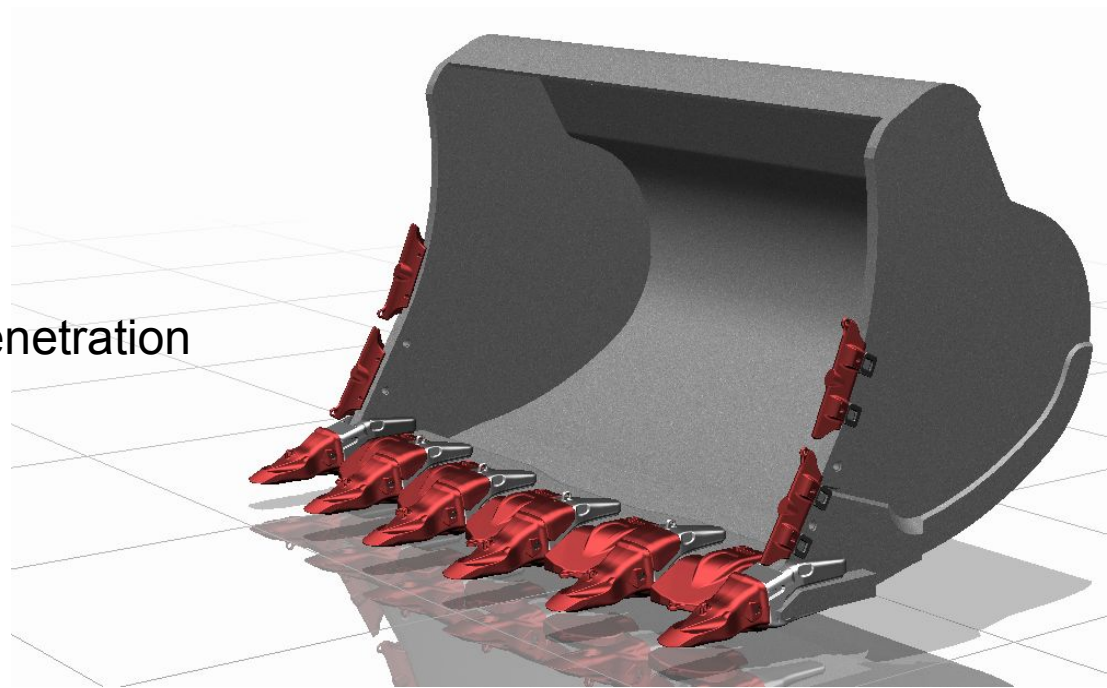

# RANGE OF PRODUCTS

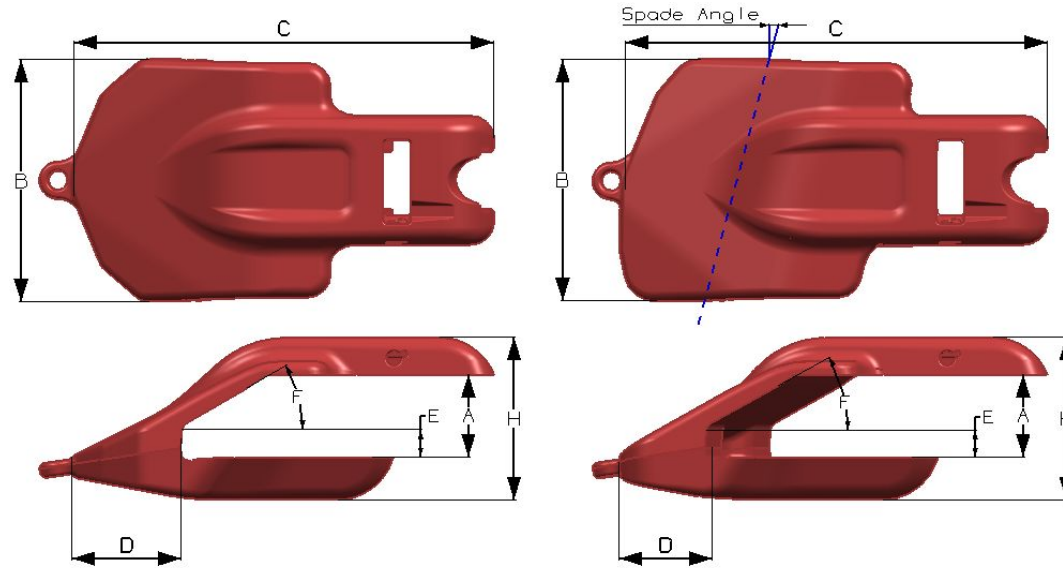

Reference	Weight (Kg)	Spade Angle	A	B	C	D	E	F	H
4MX100LD290	74	15-22	100	290	615	180	25-30	30	226
4MX100C290	72,3	15-22	100	290	615	180	25-30	30	226
4MX100RD290	74	15-22	100	290	615	180	25-30	30	226
4MX120LD410	110,2	15-22	120	410	615	185	35-42	30	258
4MX120C410	106,8	15-22	120	410	615	185	35-42	30	258
4MX120RD410	110,2	15-22	120	410	615	185	35-42	30	258
4MX140LD420	150,7	15-22	140	420	740	190	44-46	30	281
4MX140C420	145,3	15-22	140	420	740	190	44-46	30	281
4MX140RD420	150,7	15-22	140	420	740	190	44-46	30	281

# RANGE OF PRODUCTS

Symmetric

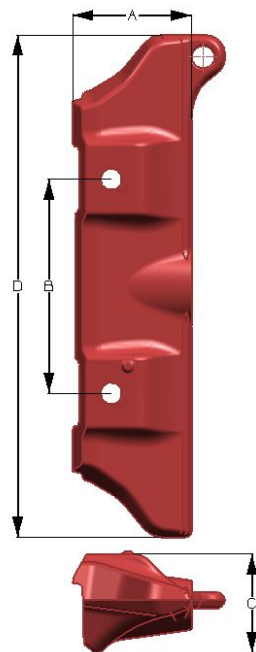

Asymmetric

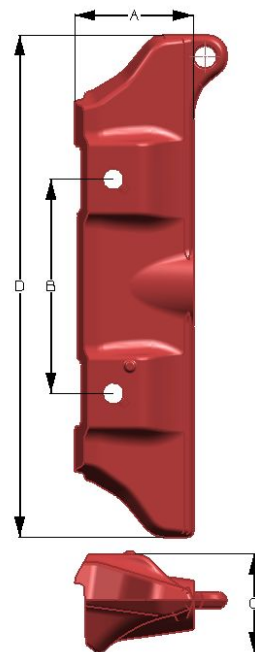

Reference	Weight (Kg)	Lateral Bucket	A	B	C	D
4MX30/50LS	12,3	30-50	103,4	225	95	480
4MX30/50LA	11,4	30-50	89	225	96	480
4MX60/80LS	28,4	60-80	144	260	120	610
4MX60/80LA	24,6	60-80	145	260	122	610



# STARMET + PROMET

	Adapter	Lip Shrouds			Lateral Protector	
		Left	Center	Right	Symmetric	Asymmetric
Size 180	1MA180W 1MA180WC/					
Size 240	MMA240WC 1MA240WC3/ MMA240WS	4MX100LD29 0	4MX100C29 0	4MX100RD29 0		
	3MA240W 1MA240WC/					
Size 500	MMA500WC 1MA500WC5/ MMA500WS	4MX120LD41 0	4MX120C41 0	4MX120RD41 0	4MX60/80L S	4MX60/80L A
	5MA500WC 1MA500WC3/ M1MA500W 1MA500WC/ M1MA500W	4MX140LD42 0	4MX140C42 0	4MX140RD42 0		

S



Thank  
you