

ЗЕРТХАНАЛЫҚ ЖҰМЫС

ОРЫНДАҒАН: АЙДЫНБЕКОВА А
ҚАБЫЛДАҒАН: АШИРБЕКОВА Ж
ТОБЫ: ИП183К2

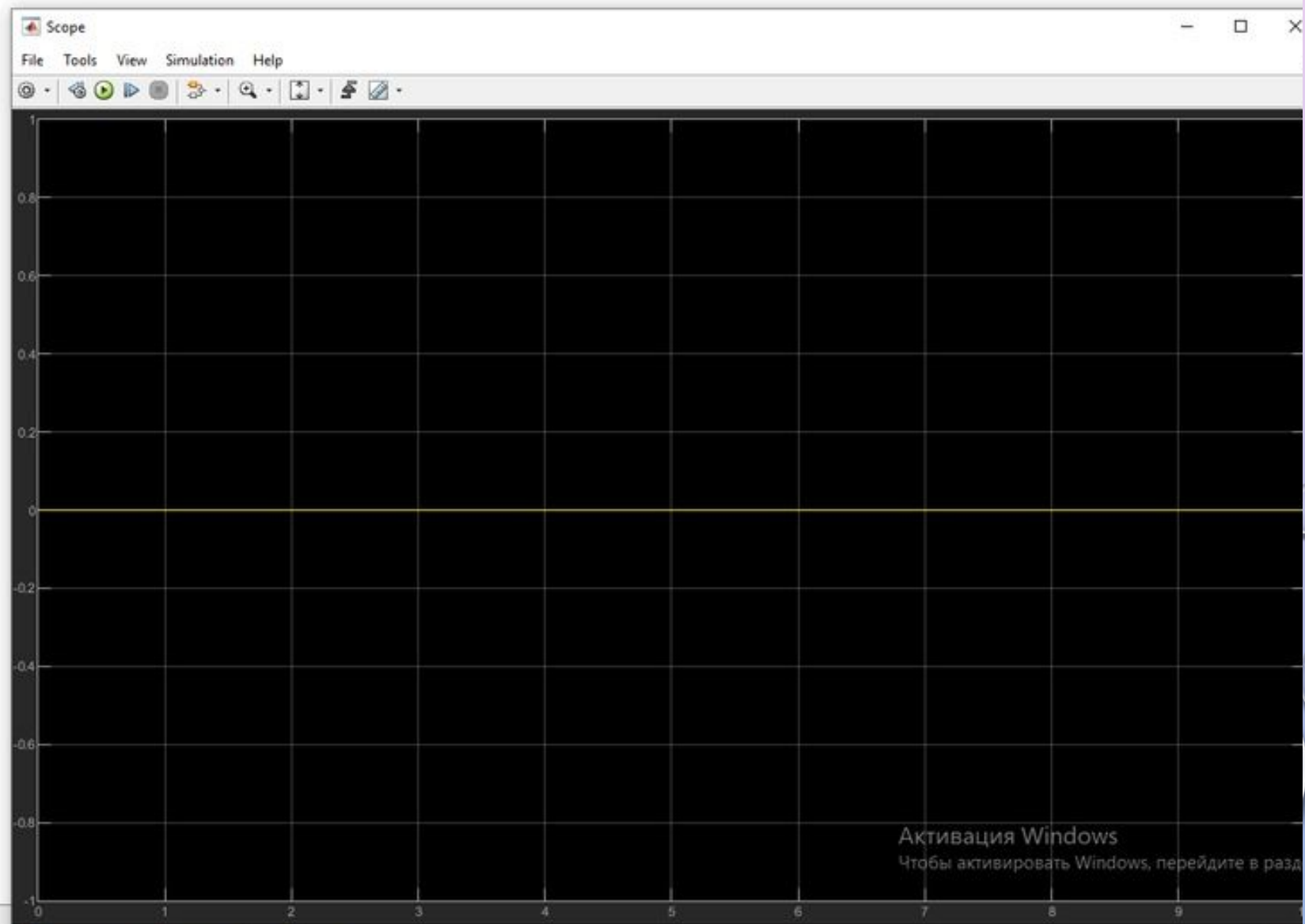

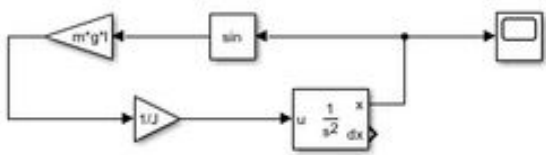
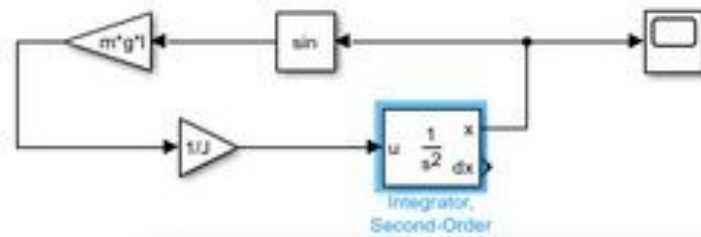

Block Parameters: Integrator, Second-Order

Second-Order Integrator

Second-order continuous-time integration of the input signal.

x dx/dt Attributes

Initial condition source x: internal

Initial condition x:
0.01

Limit x

Wrap x

Absolute tolerance x:
auto

State name x:

OK Cancel Help Apply

SIMULATION DEBUG MODELING FORMAT APPS **SCOPE**

Stop Time: 10.0
Normal
Fast Restart

Step Back Run Step Forward Stop

Data Inspector Logic Analyzer Bird's-Eye Scope

REVIEW RESULTS

untitled

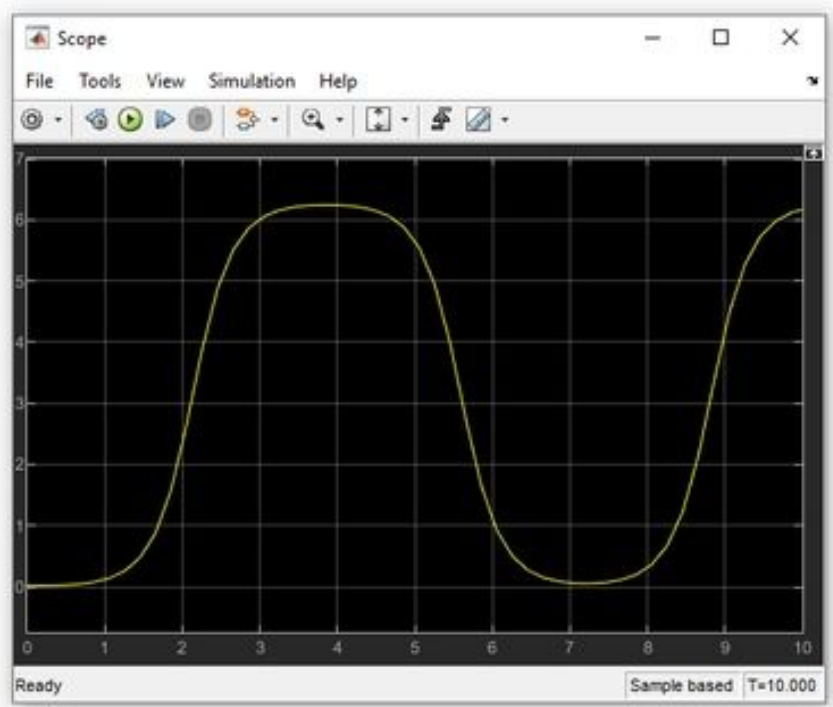

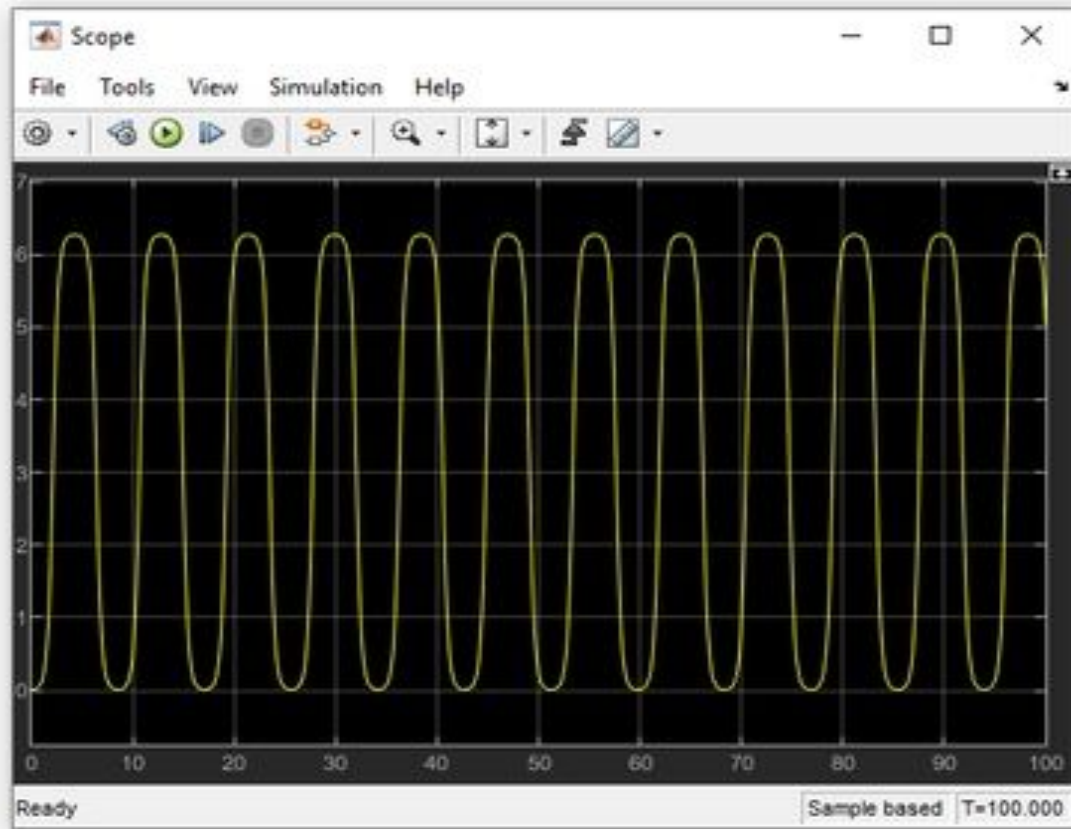
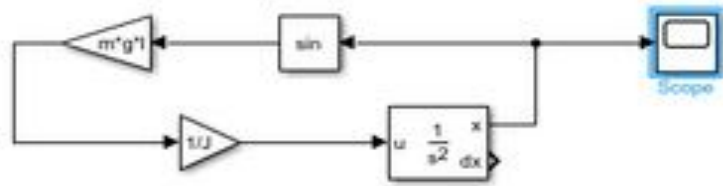

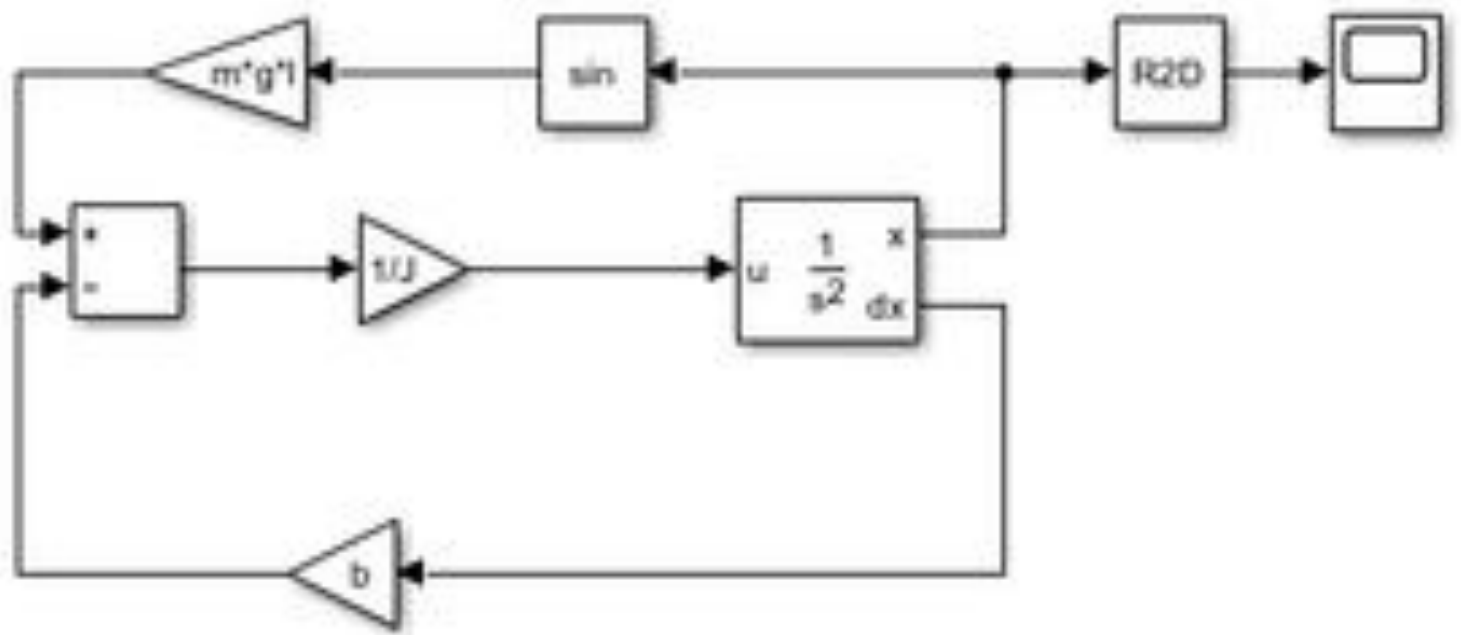

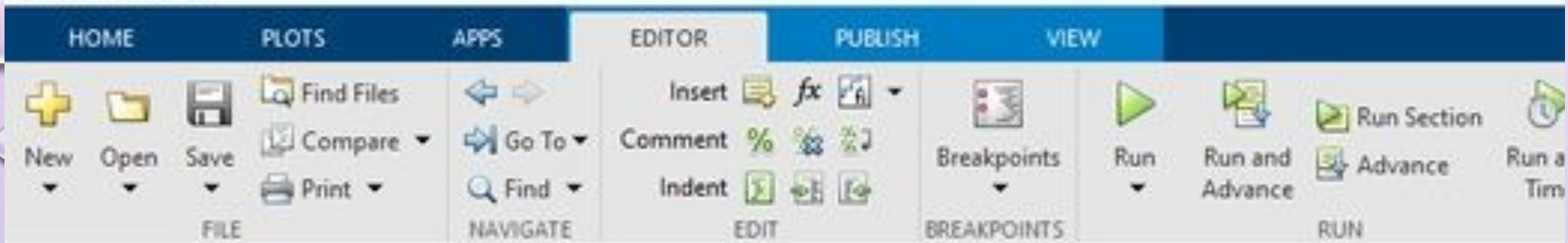

E:\Polyspace\R2020a\bin

Current Folder

Name

- icutzdata
- m3iregistry
- util
- win32
- win64
- crash_analyzer.cfg
- deploytool.bat
- init.m
- lcdata.xml
- lcdata.xsd
- lcdata_utf8.xml
- matlab.exe
- mbuild.bat
- mcc.bat
- mex.bat
- mexext.bat
- mw_mpiexec.bat

Editor - E:\Polyspace\R2020a\bin\init.m

```
init.m x +  
1 - m=1;  
2 - l=1;  
3 - J=m*l^2;  
4 - g=9.8;  
5 - b=0.1;  
6 - b=0.1;  
7
```

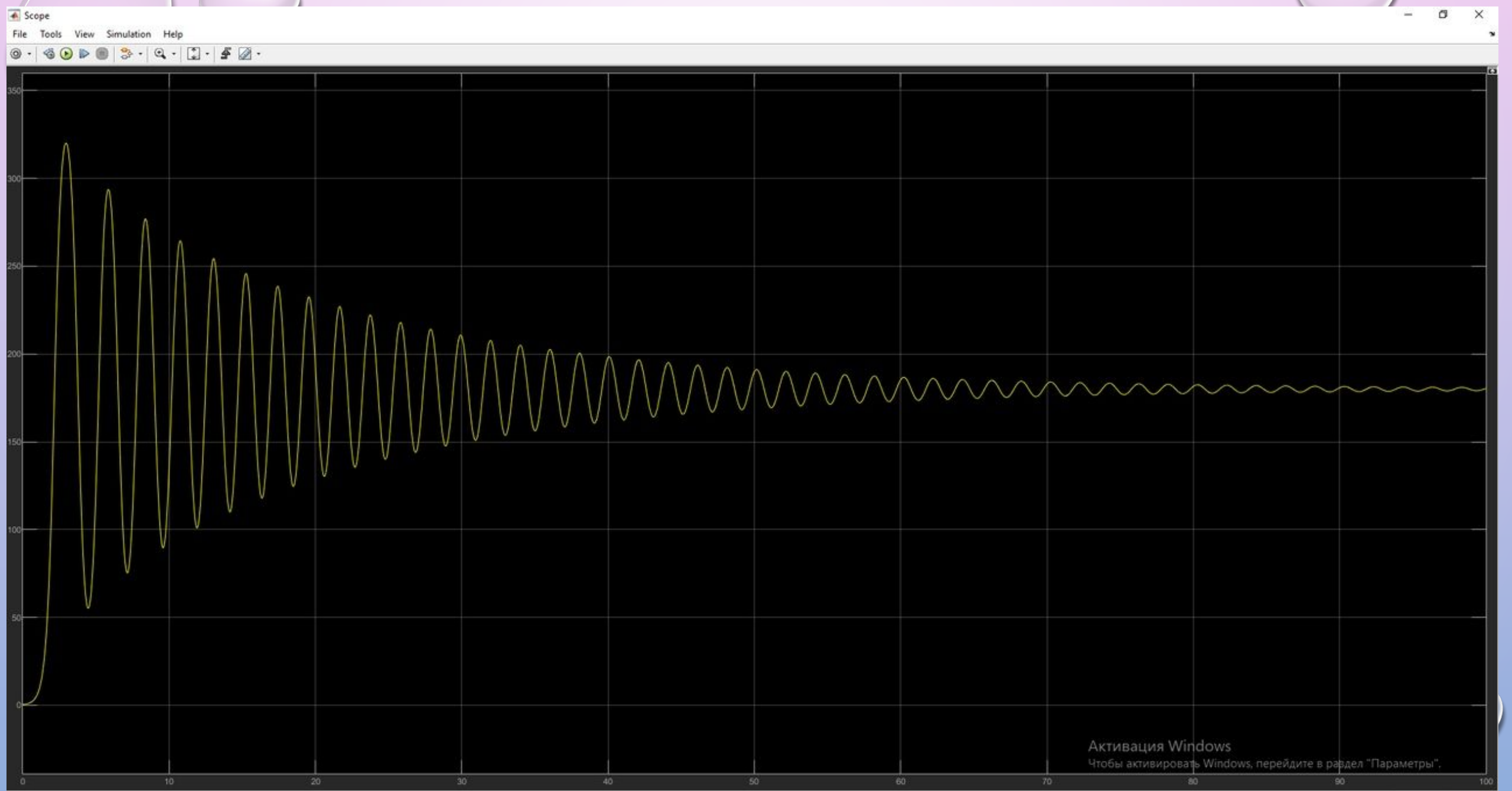

Активация Windows
Чтобы активировать Windows, перейдите в раздел "Параметры".