

Задачи на ГОТОВЫХ чертежах

Вписанные и невписанные углы

1	5	9	13	17	21	25	29
2	6	10	14	18	22	26	30
3	7	11	15	19	23	27	31
4	8	12	16	20	24	28	

Литература

Задача 1

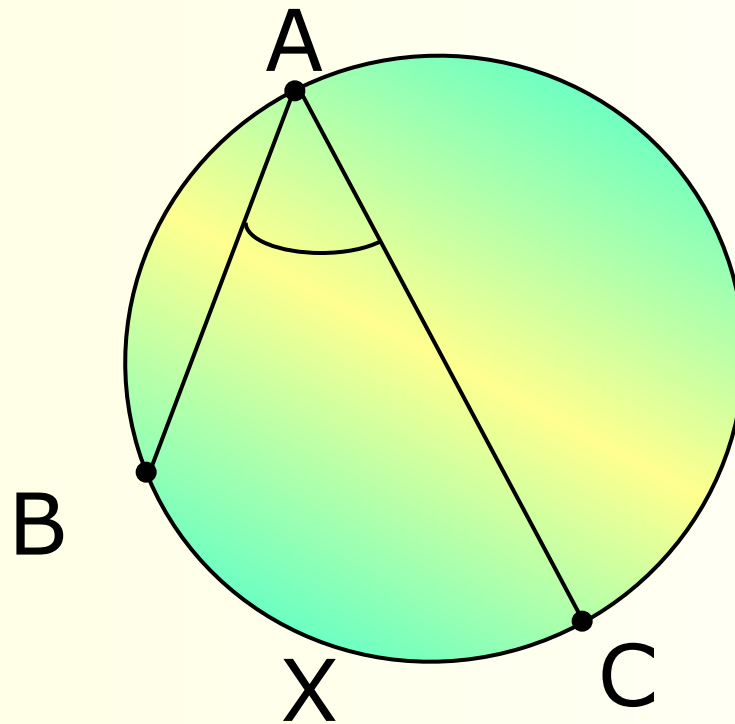

$$\square BAC = 41^{\circ}15'$$

$$\square BAC, \square BXC - ?$$



Задача 2

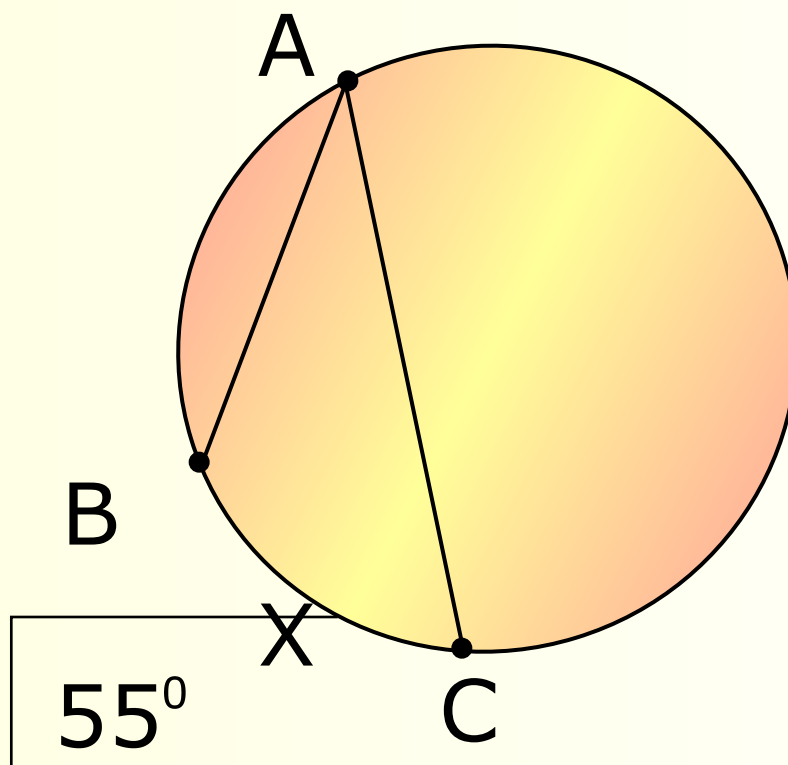

$BXC = 55^\circ$

$BAC = ?$



Задача 3

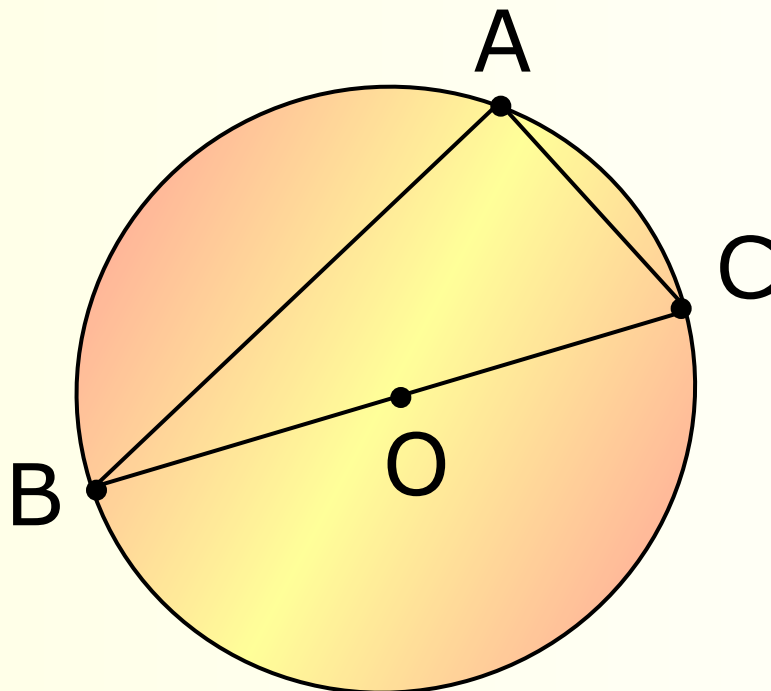

$BAC - ?$



Задача 4

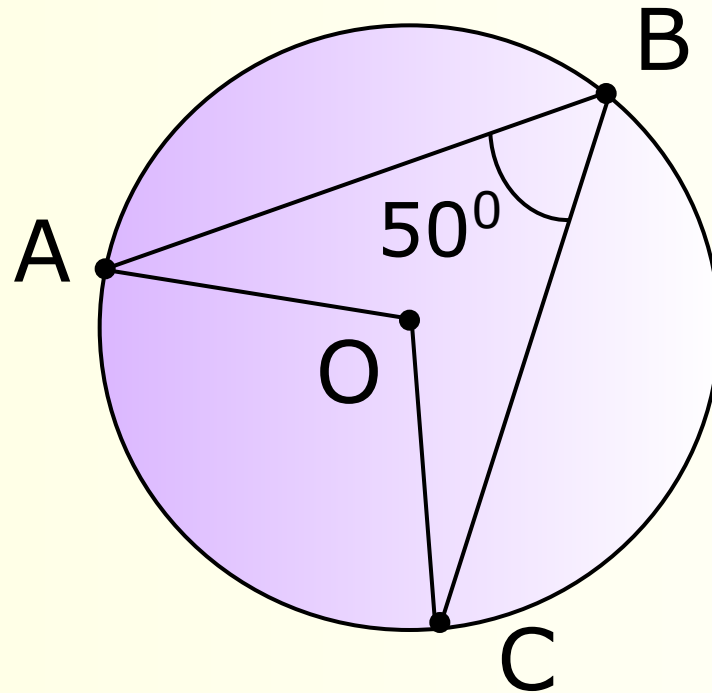

$$\square AB : \square BC = 5 : 8$$

$$\square ABC = 50^\circ$$

$$\square AB, \square BC, \square AC, \square AOC$$



Задача 5

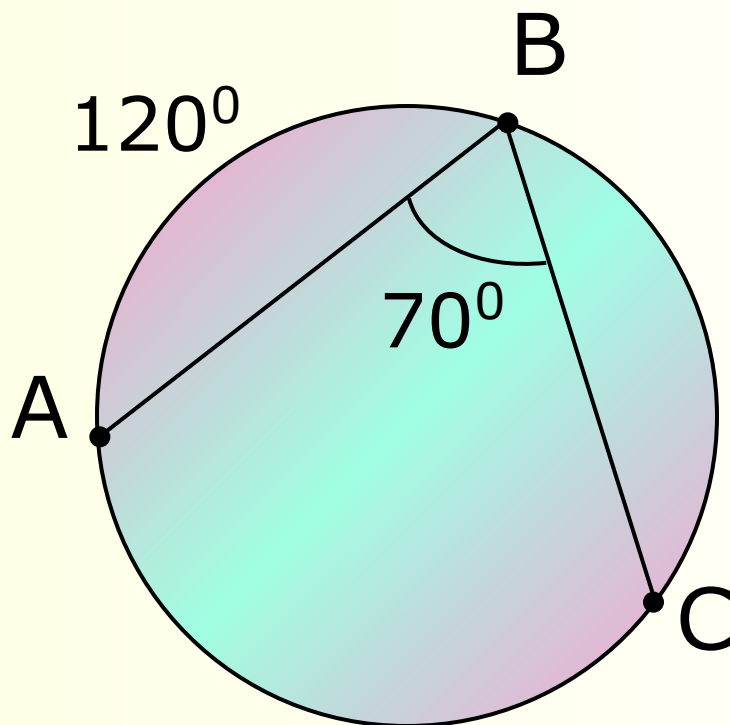

$\square AB = 120^\circ, \square ABC = 70^\circ$

$\square BC = ?$



Задача 6

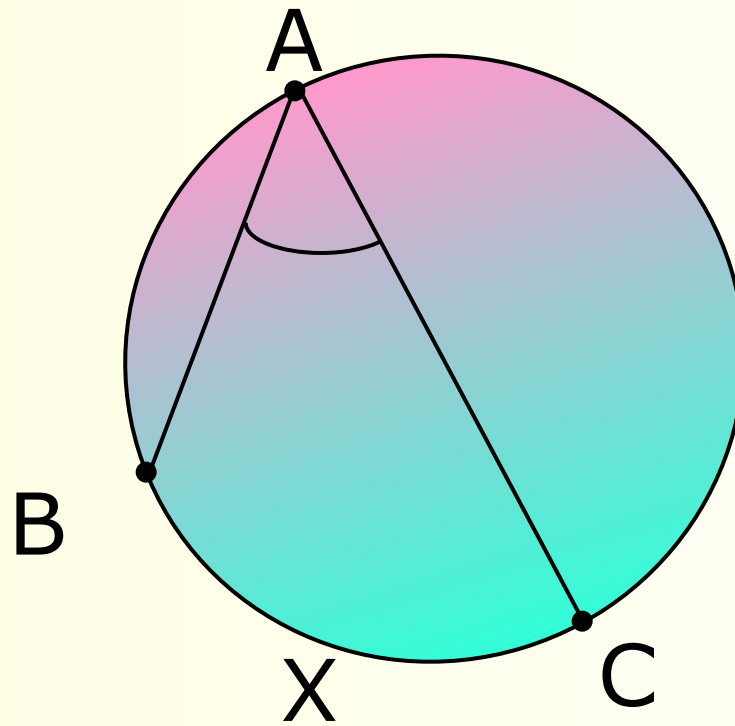

$$\angle BAC : \angle BXC = 5 : 3$$

$$\angle BAC = ?$$



Задача 7

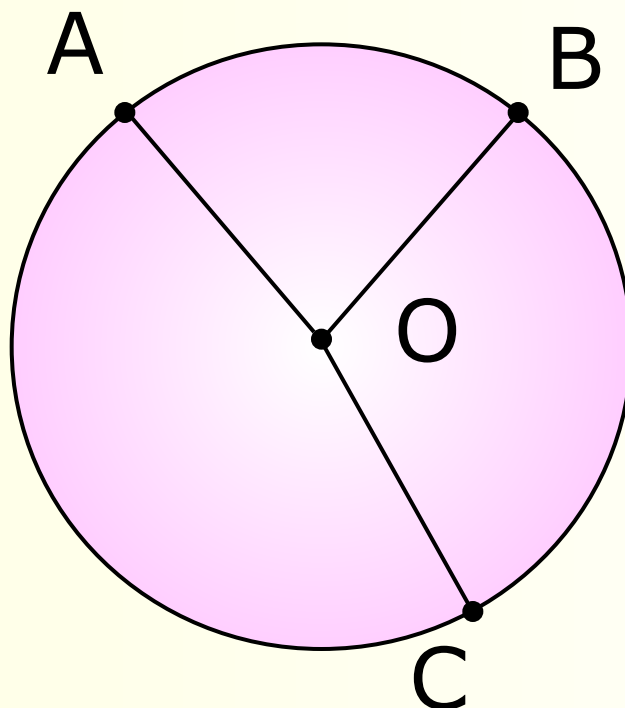

$$\square AB : \square BC : \square AC = 2 : 7 : 9$$

$$\square AOB, \square BOC, \square AOC$$



Задача 8

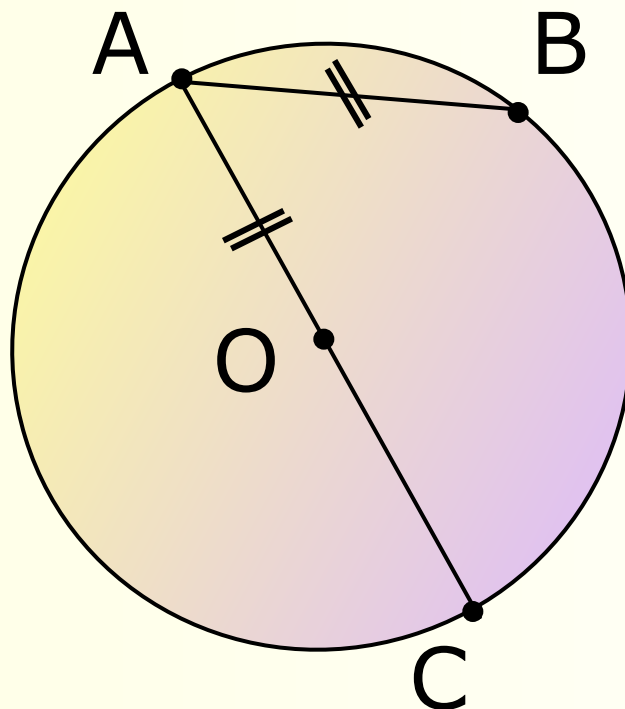

$$AB = AO$$

□ CAB - ?



Задача 9

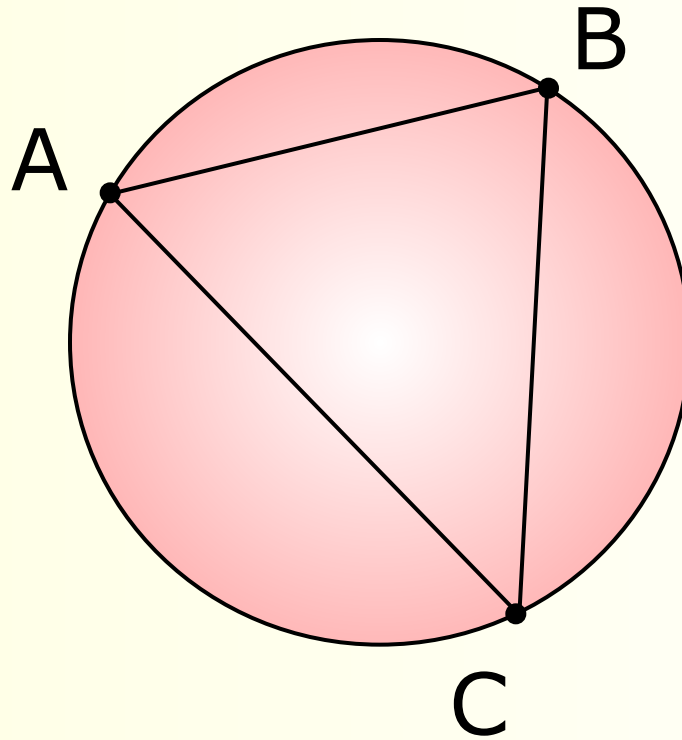

$$\square AB : \square BC : \square AC = 5 : 6 : 7$$

$\square ACB, \square BAC, \square ABC - ?$



Задача 10

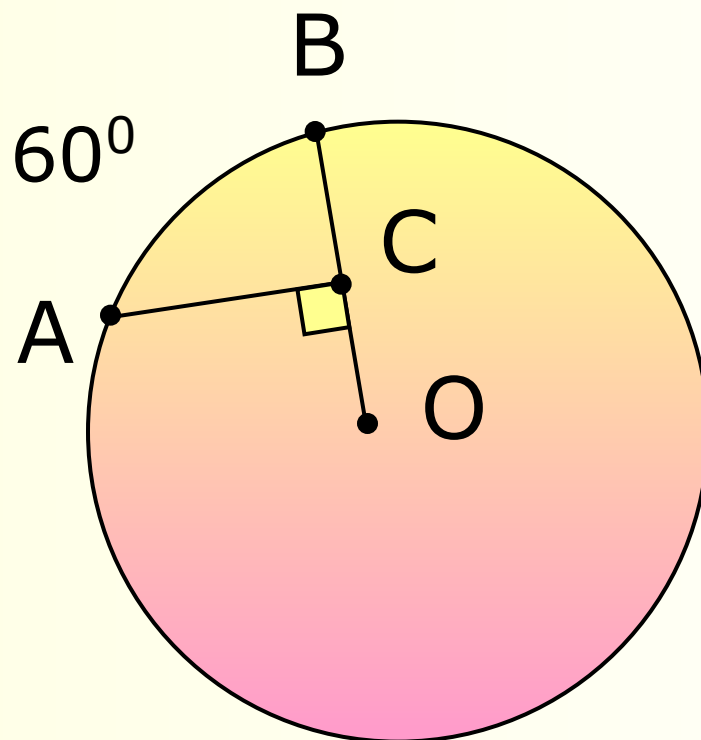

$$\square AB = 60^\circ, OB = 6 \text{ см}$$

$AC = ?$



Задача 11

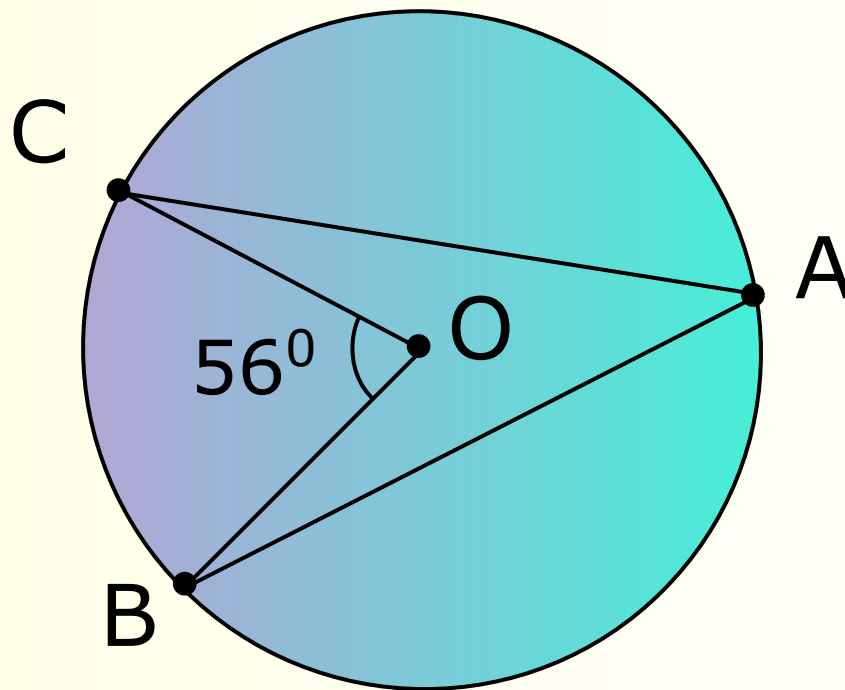

$\angle CAB - ?$



Задача 12

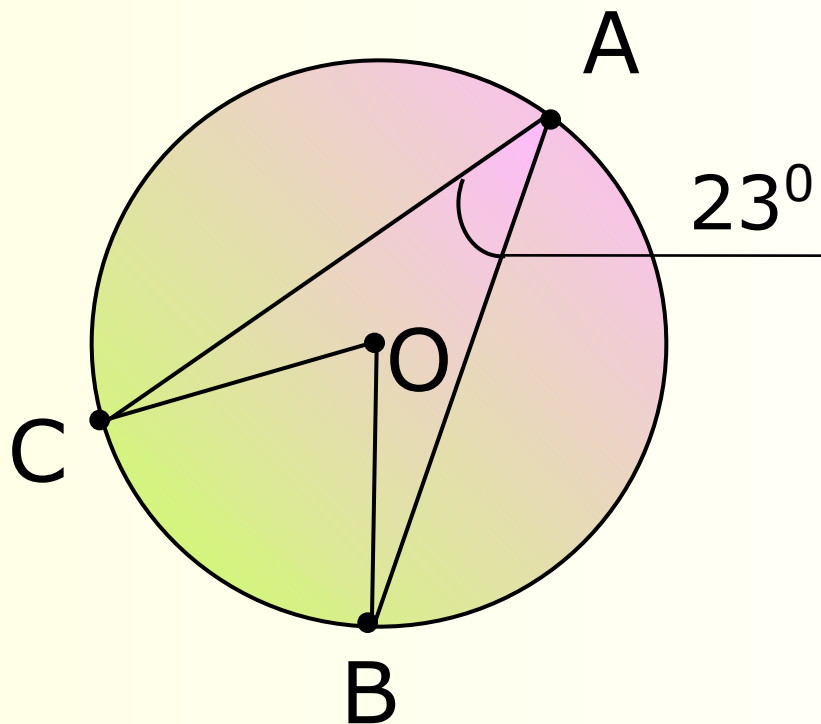

□ $\angle COB = ?$



Задача 13

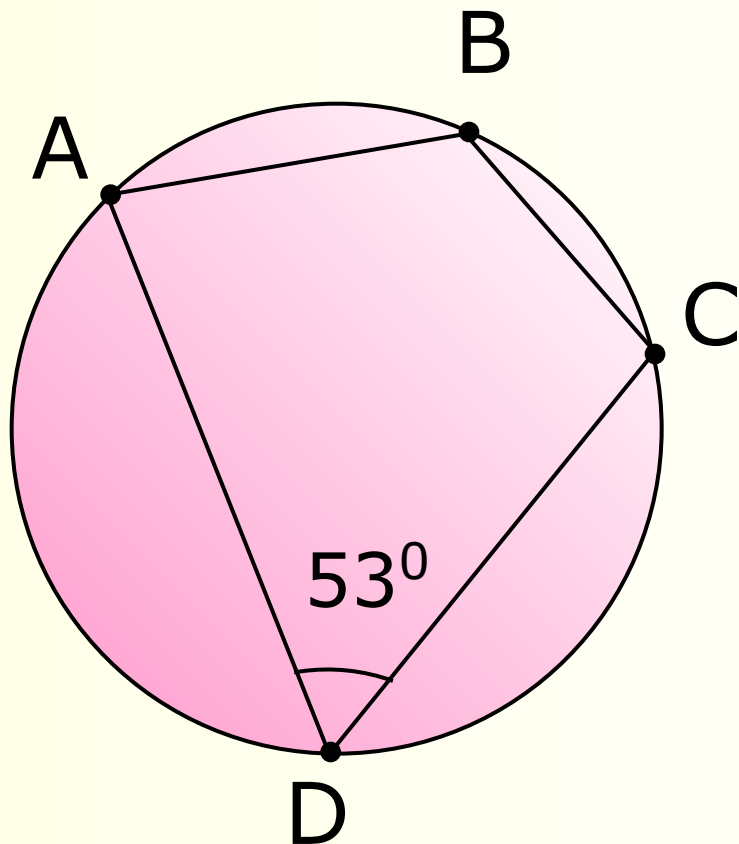

$ABC - ?$



Задача 14

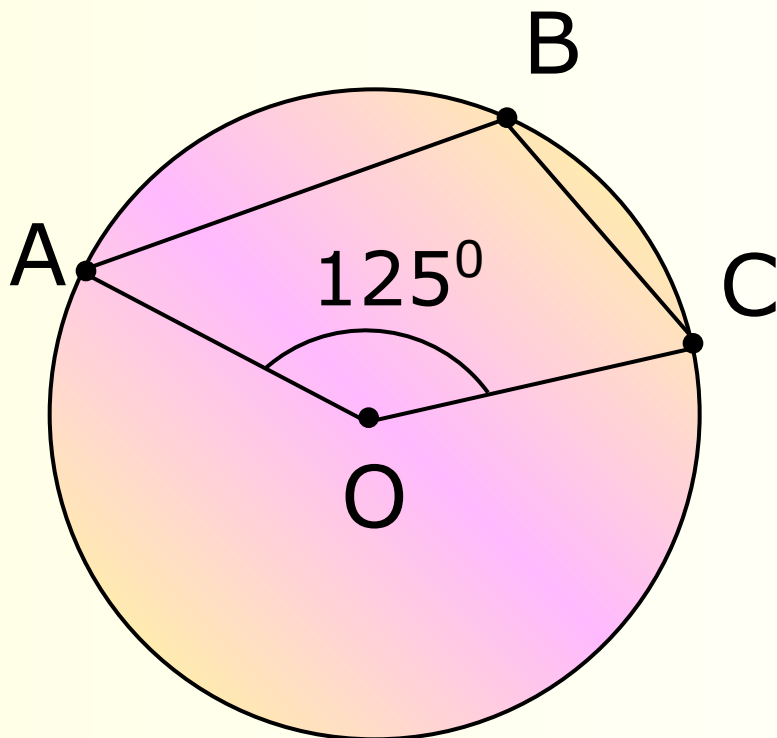

$ABC - ?$



Задача 15

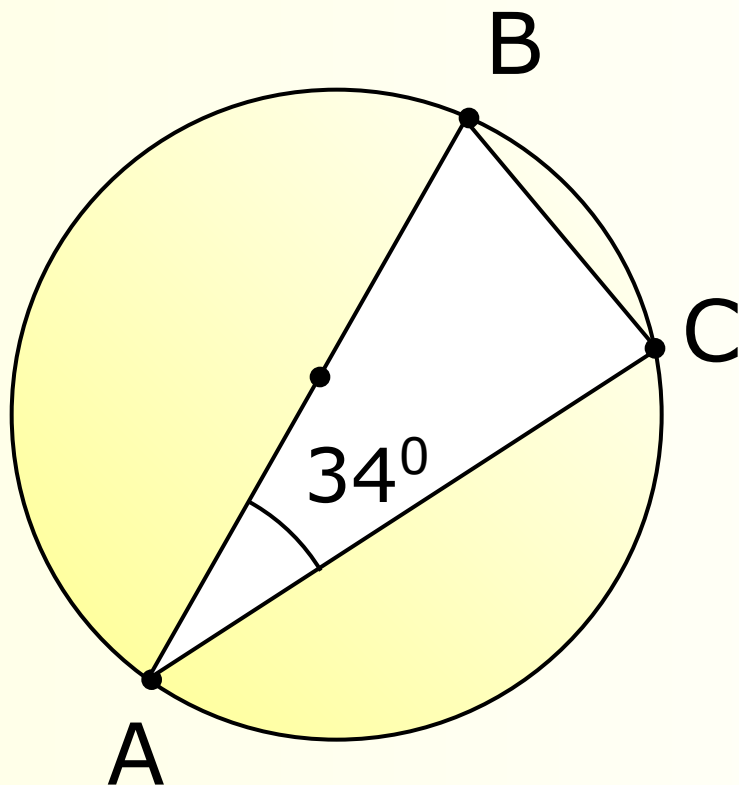

$ABC - ?$



Задача 16

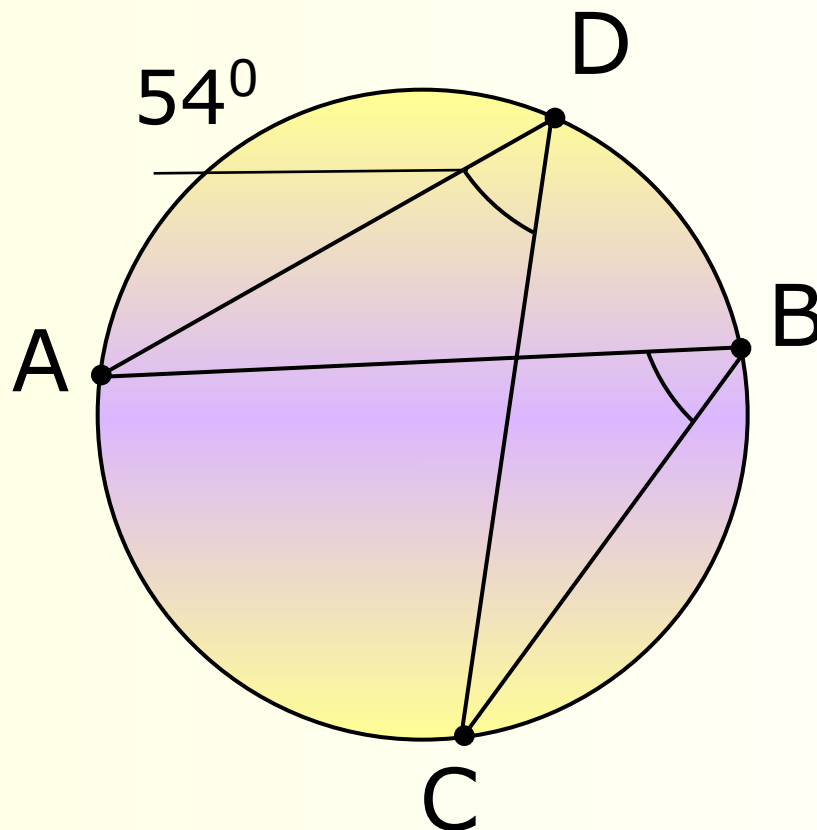

ABC - ?



Задача 17

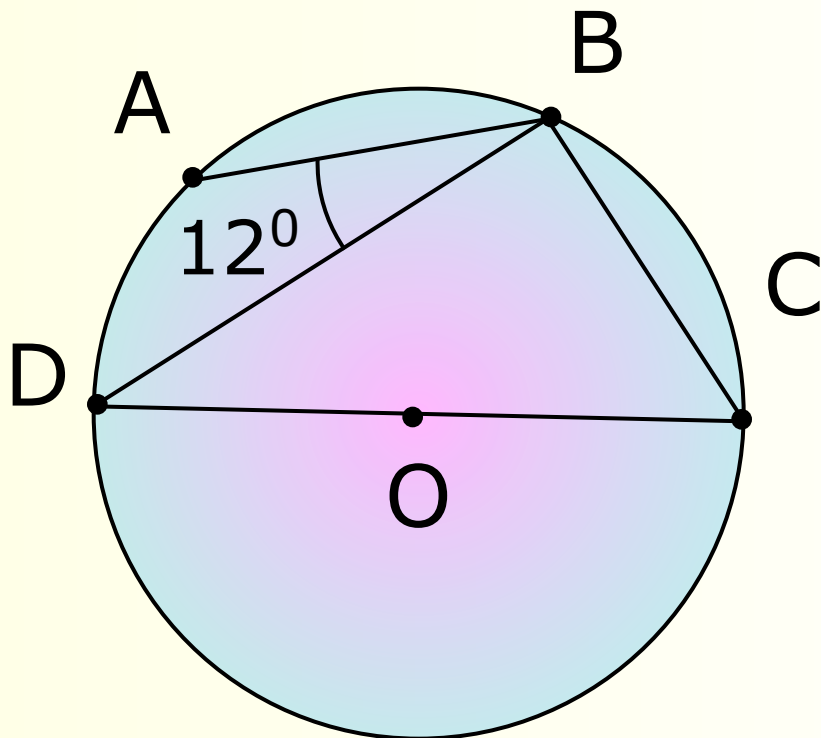

$ABC - ?$



Задача 18

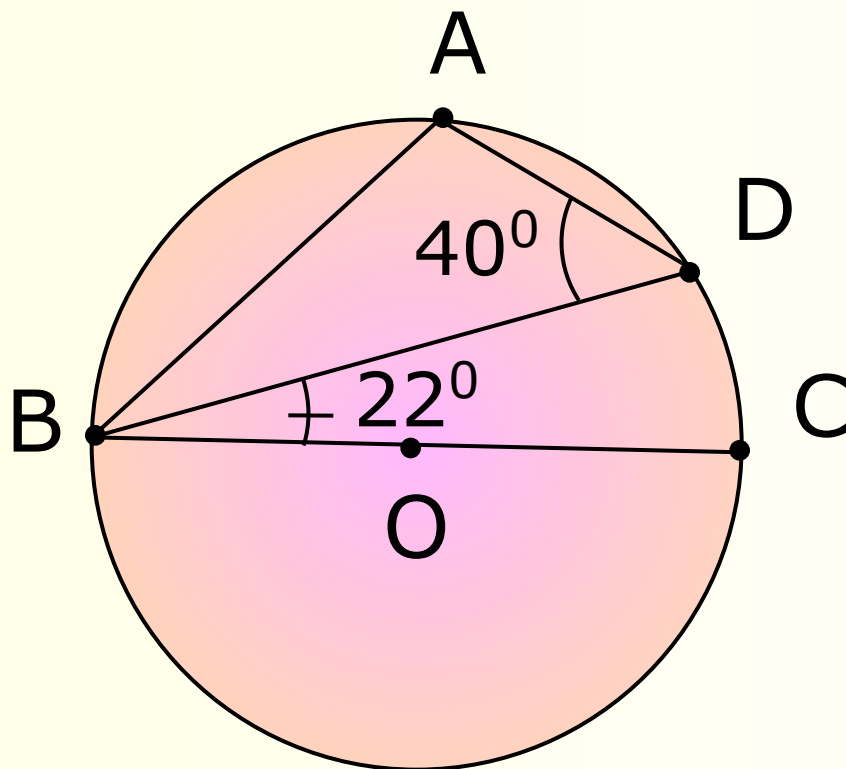

$ABC - ?$



Задача 19

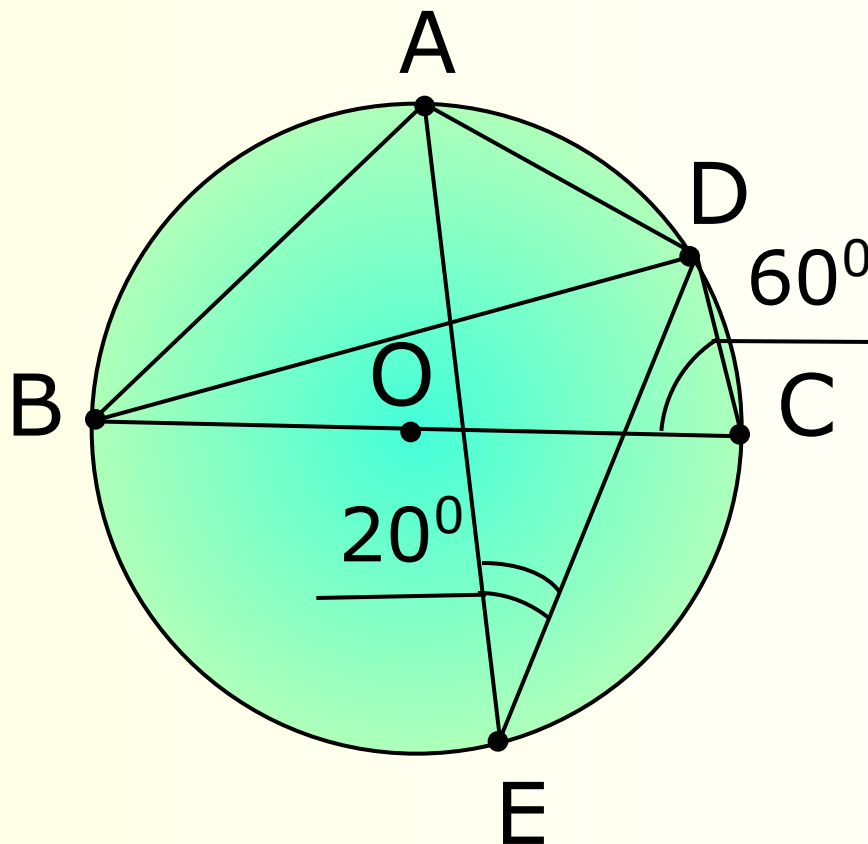

$ABC - ?$



Задача 20

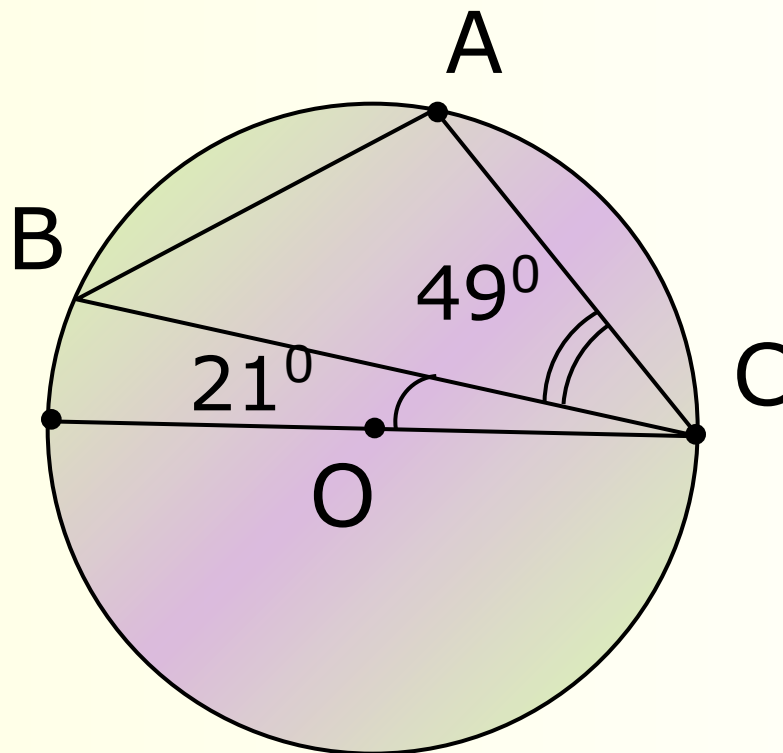

$ABC - ?$



Задача 21

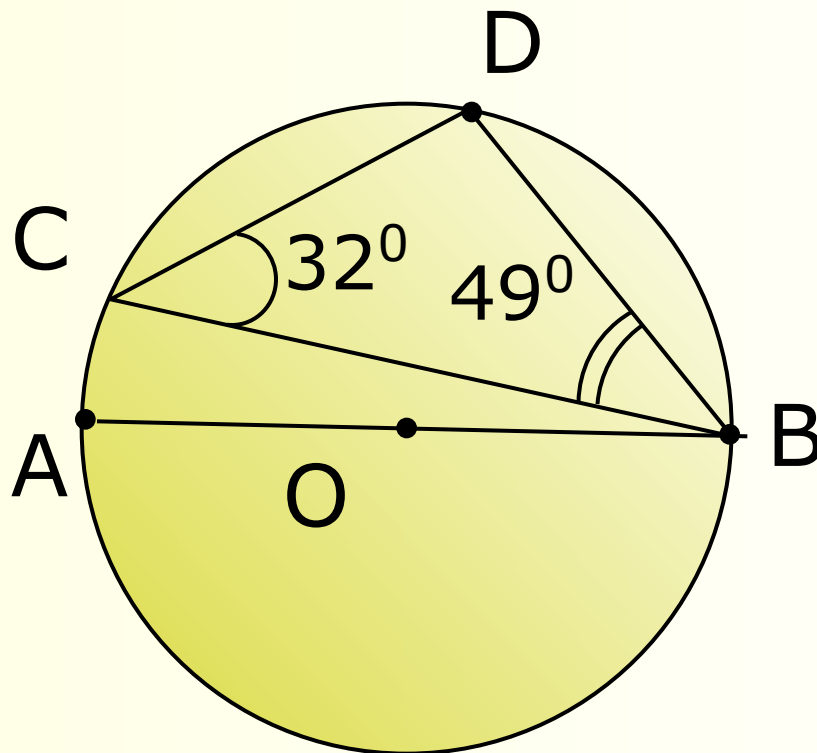

$ABC - ?$



Задача 22

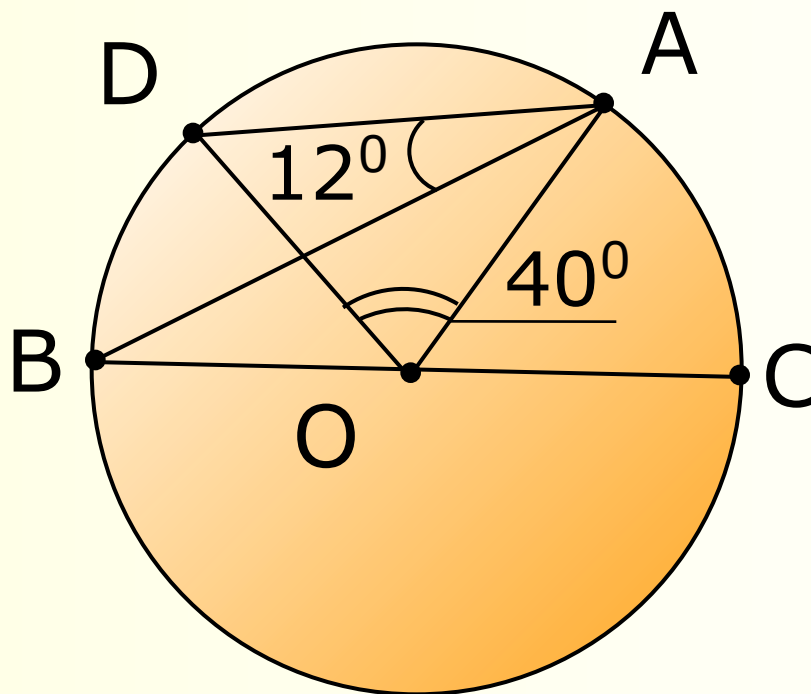

$ABC - ?$



Задача 23

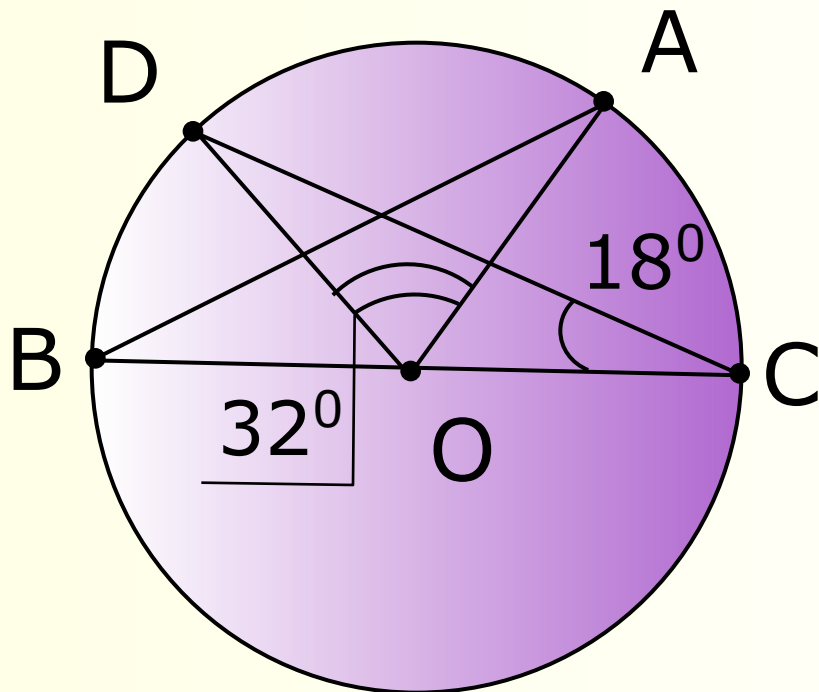

$ABC - ?$



Задача 24

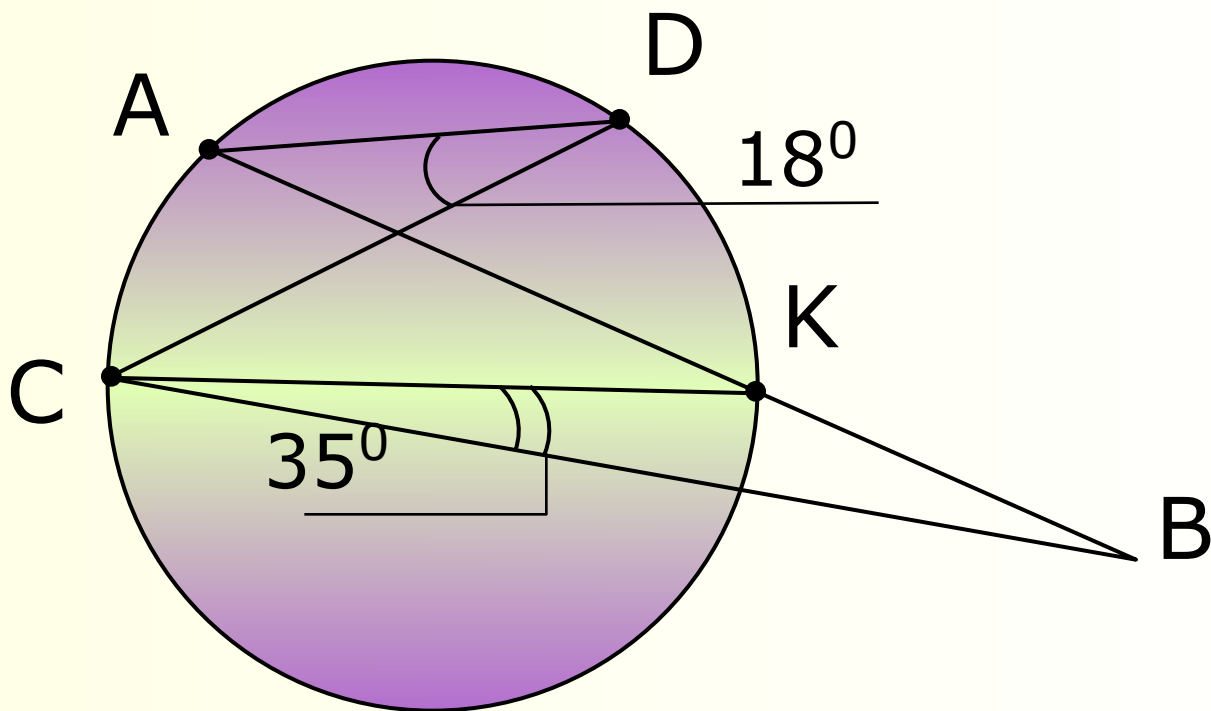

□ ABC - ?



Задача 25

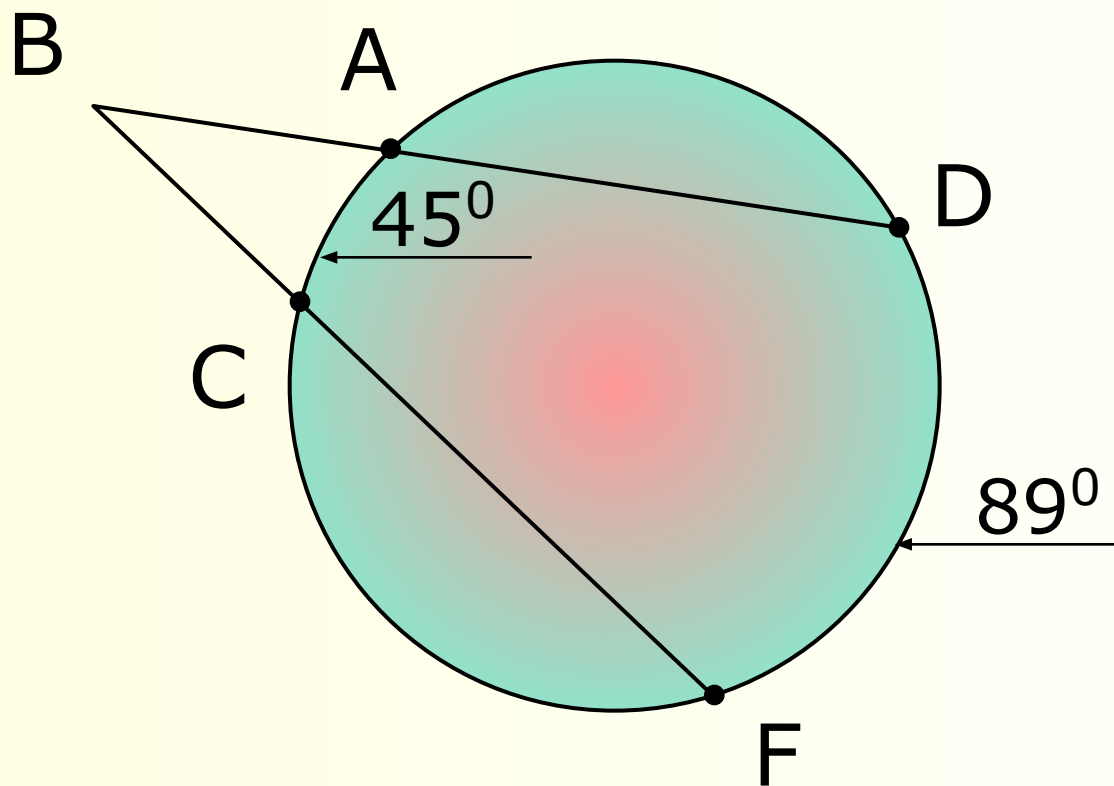

ABC - ?



Задача 26

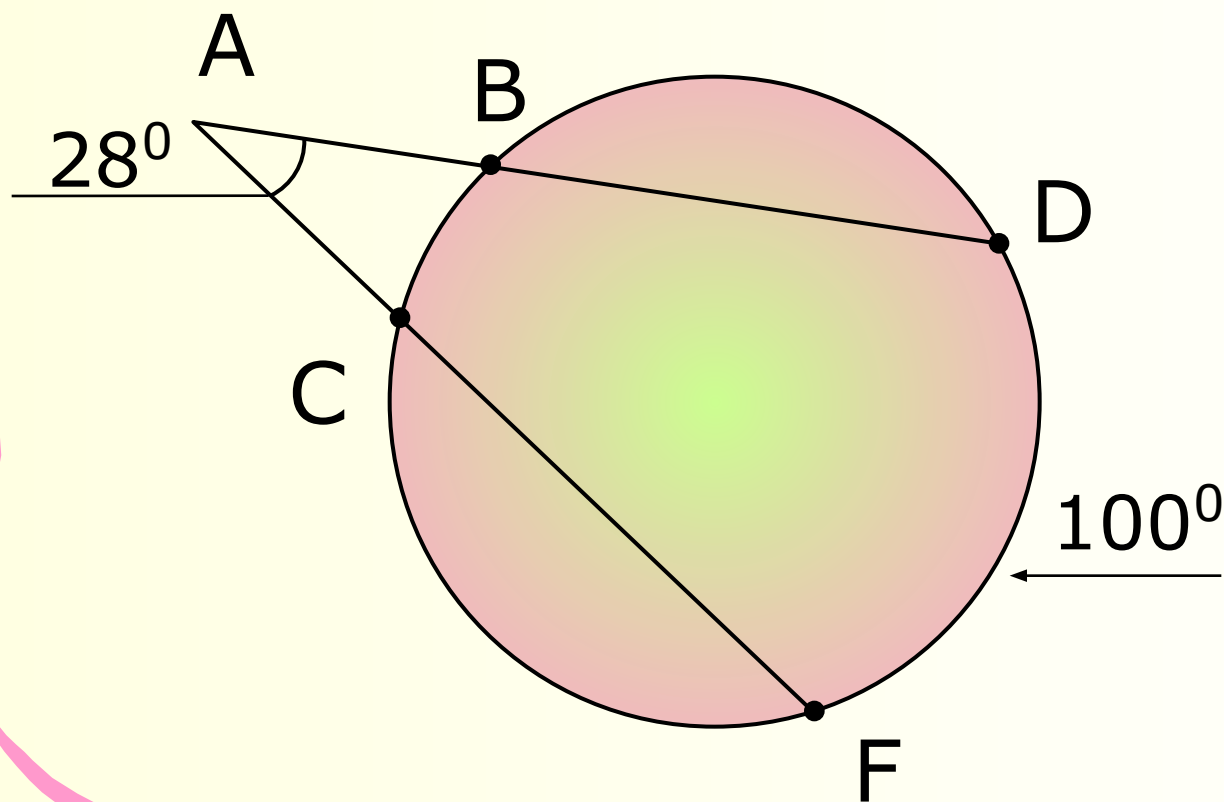

□ BC - ?



Задача 27

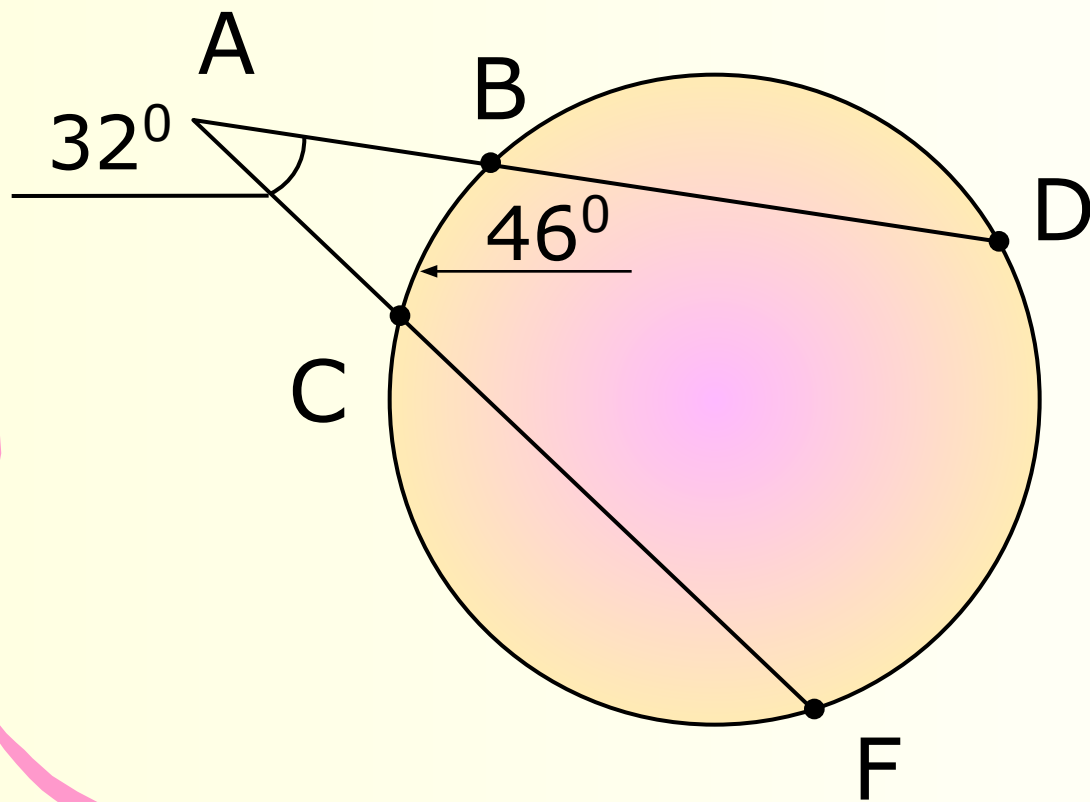

□ FD - ?



Задача 28

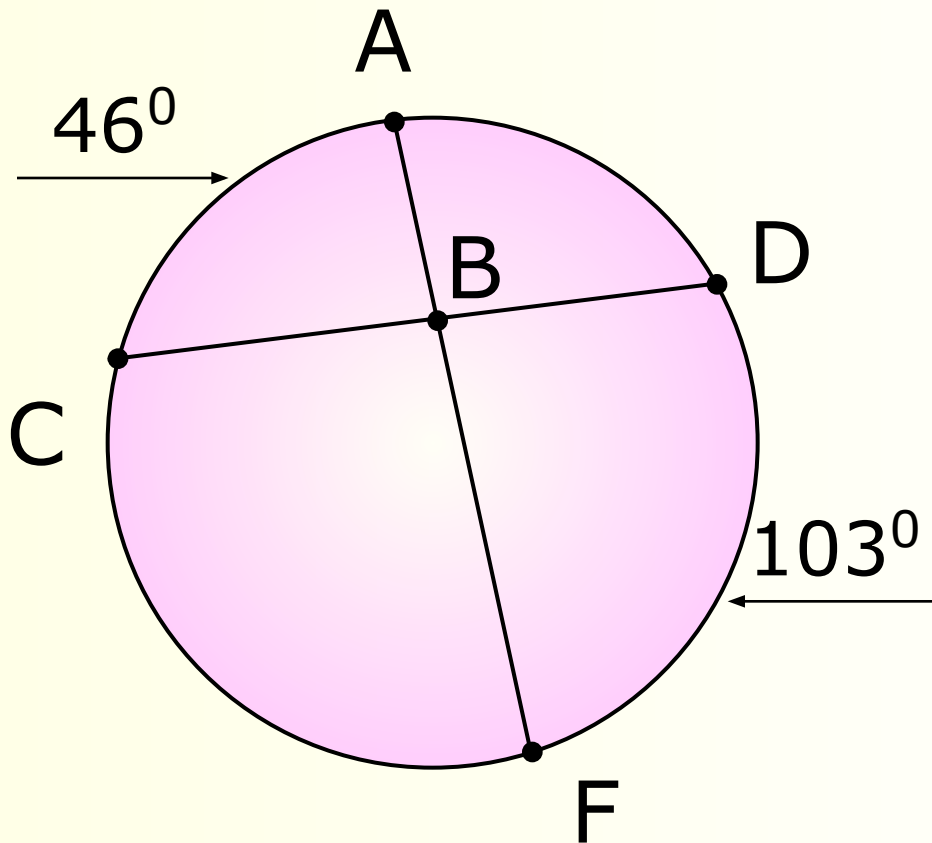

$ABC - ?$



Задача 29

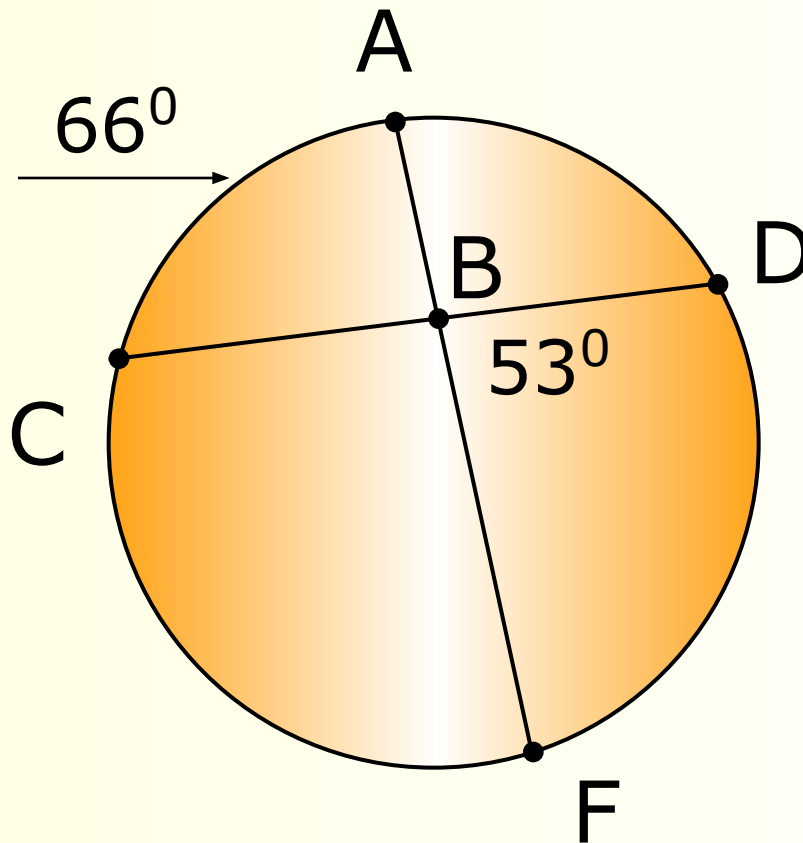

$FD - ?$



Задача 30

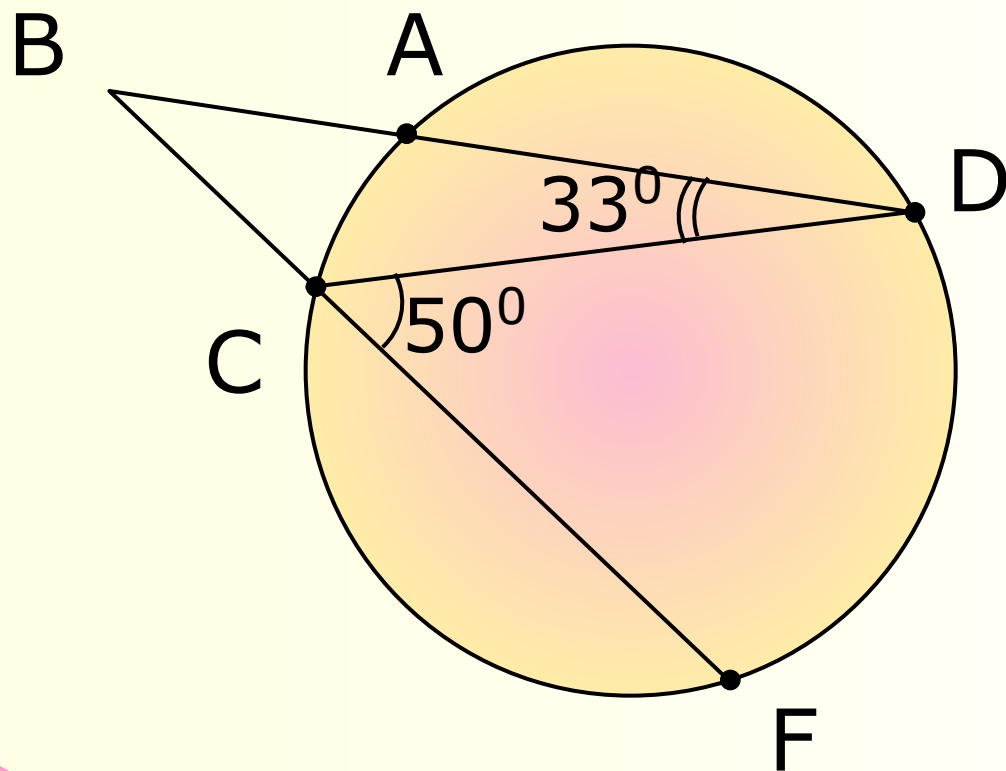

ABC - ?



Задача 31

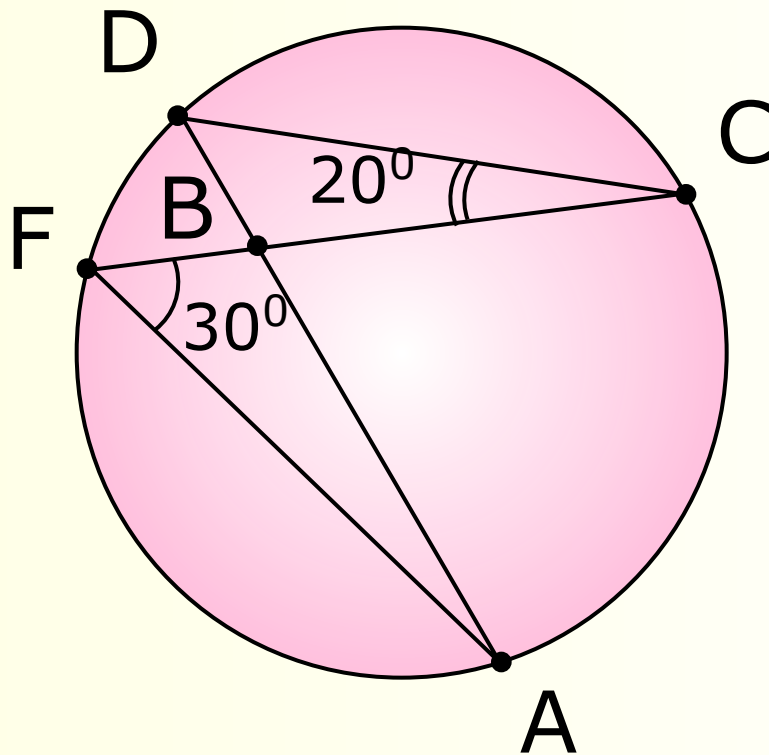

ABC - ?





Список литературы

1. Ершова А.П., Голобородько В.В, Ершова А.С
Самостоятельные и контрольные работы по алгебре и геометрии для 7-8 класса.-М:Илекса, 2004.-176с.

2. Саврасова С.М., Ястребинецкий Г.А.
Упражнения по планиметрии на готовых чертежах.-
М.: просвещение, 1987.-112 с.: ил.

3. Зив Б.Г. и др.
Задачи по геометрии: Пособие для учащихся 7-11 кл.
общеобразоват.учреждений.-М.:Просвещение, 2000.-271 с.: ил.

4. Рабинович Е.М.
Сборник задач на готовых чертежах.-К.:1996.-56с.

5. Гаврилова Н.Ф.
Поурочные разработки по геометрии: 8 класс.-2-е изд.,
перераб. и доп.-М.: ВАКО,2009.-304 с.

