

**ПОСТРОЕНИЕ
ТРЕТЬЕГО ВИДА
ПО ДВУМ
ДАННЫМ**

Ковалёв А.Н.

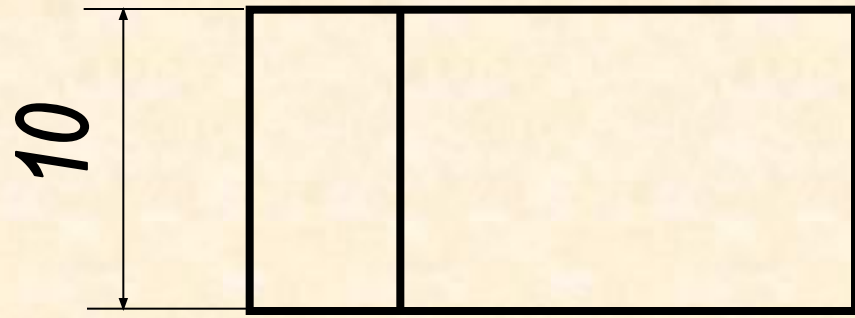

Задание.
Построить третий вид по двум данным

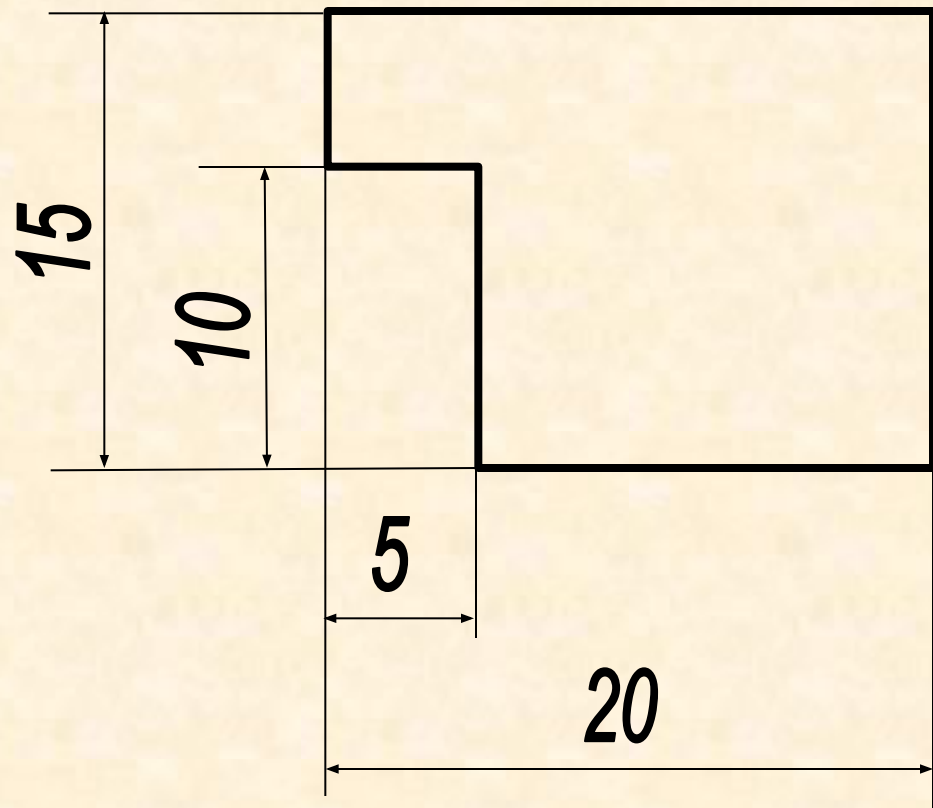

1. Построить оси

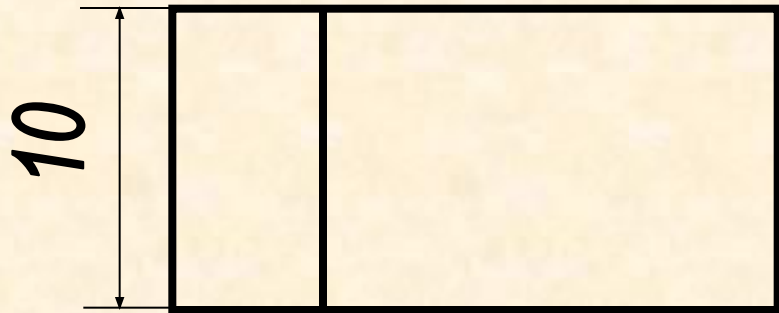

x

z

45°

y

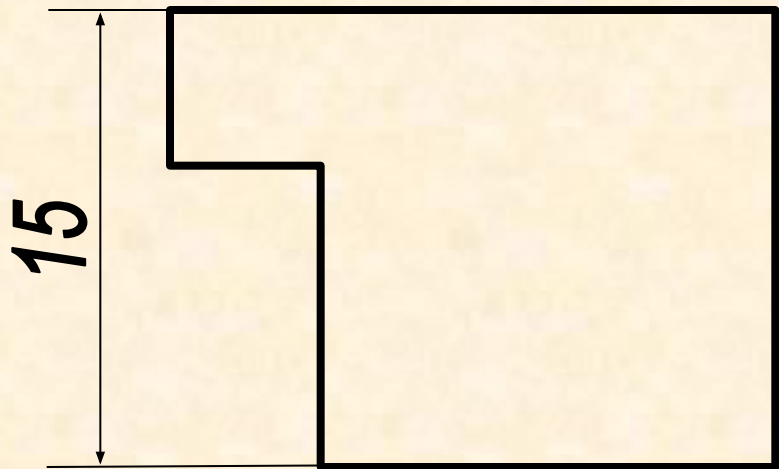

2. Построить общую форму вида слева

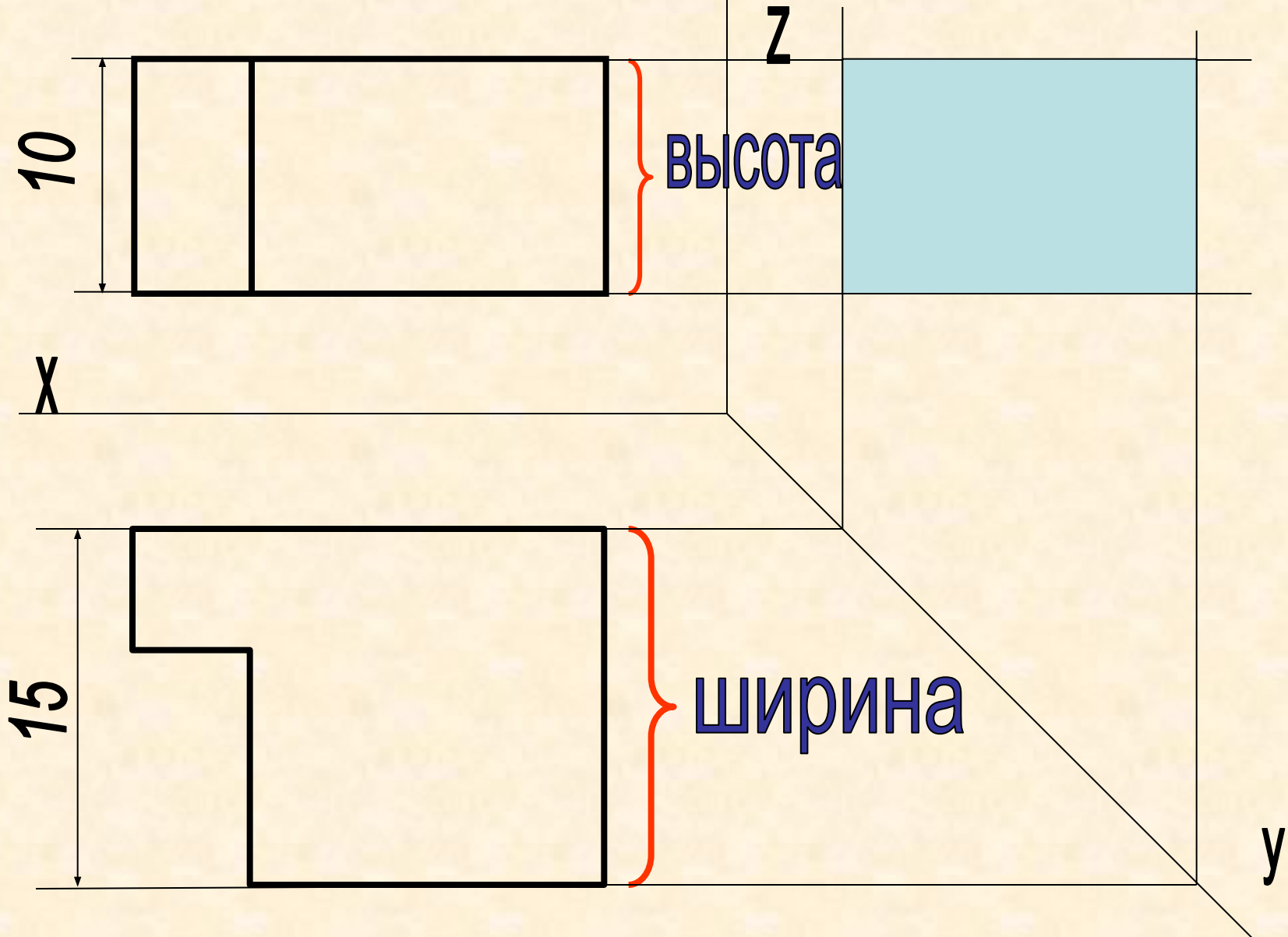

3. Построить вырез

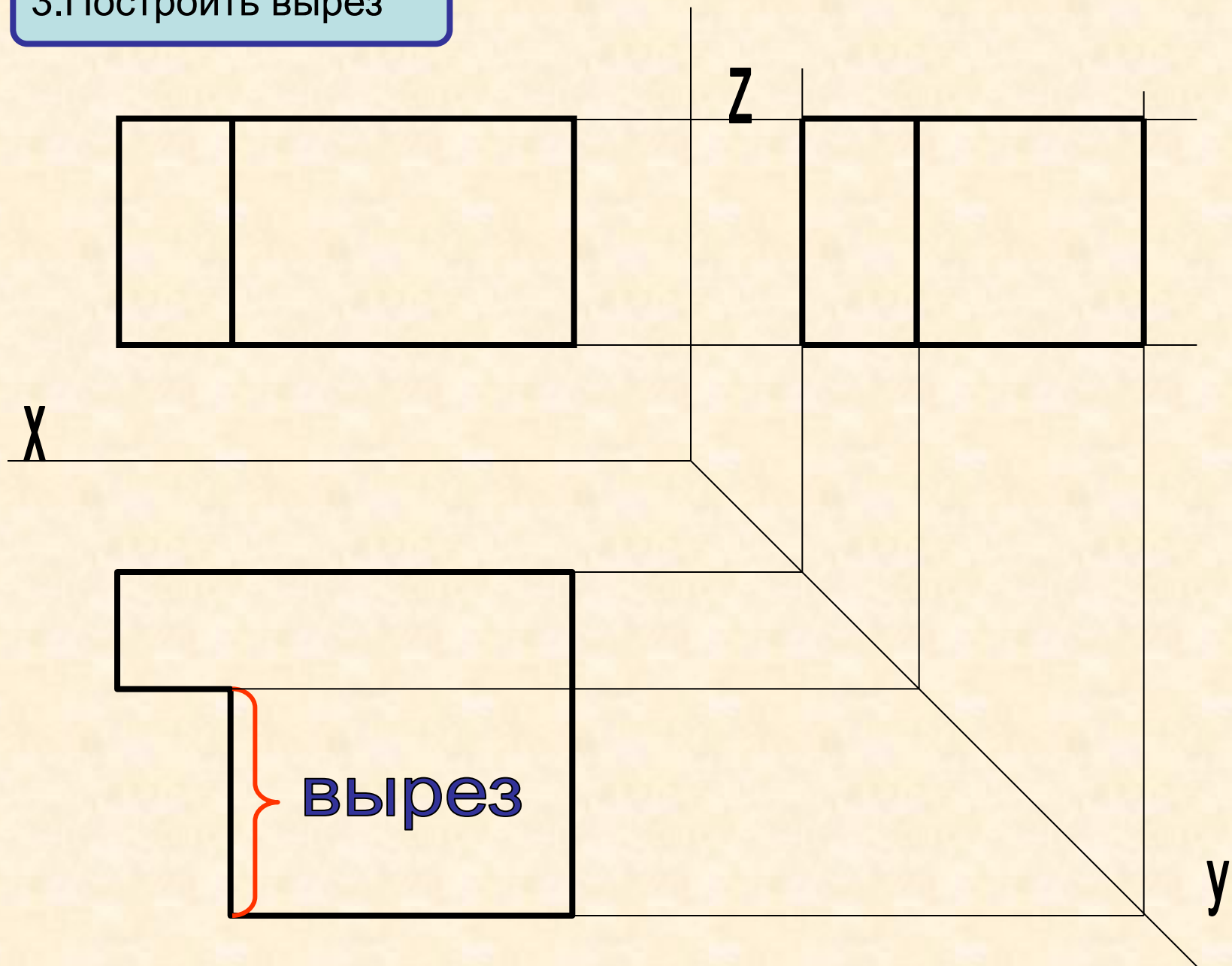

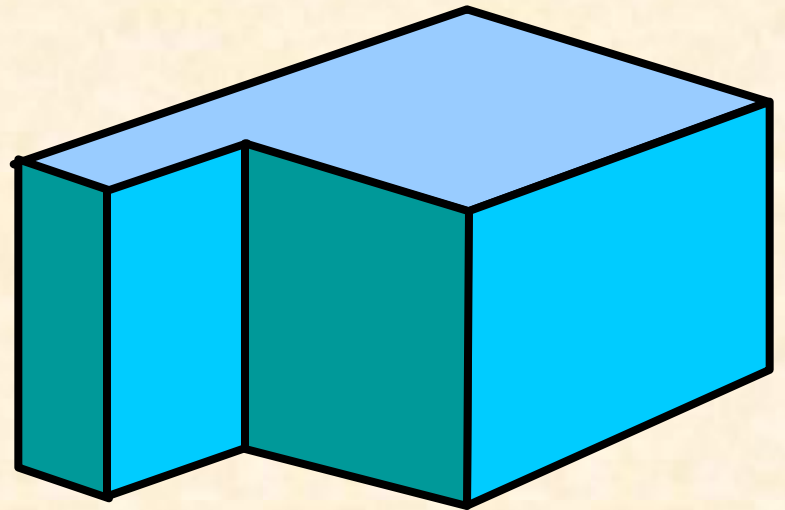
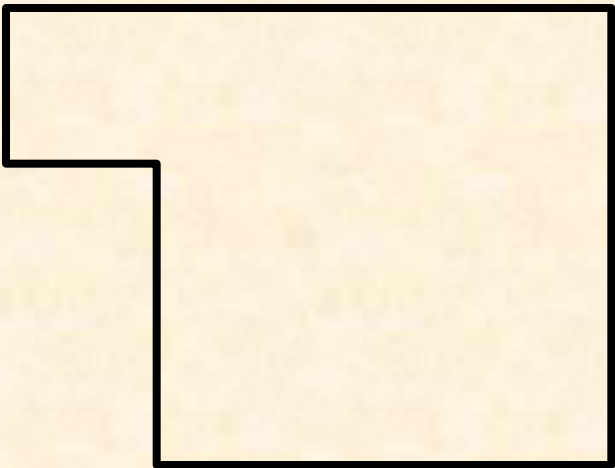
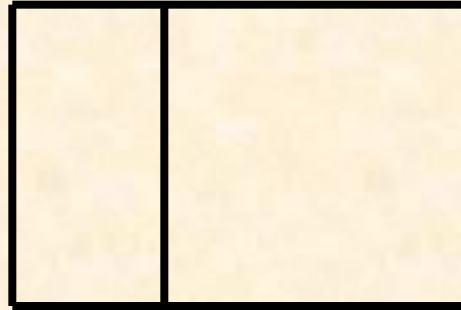

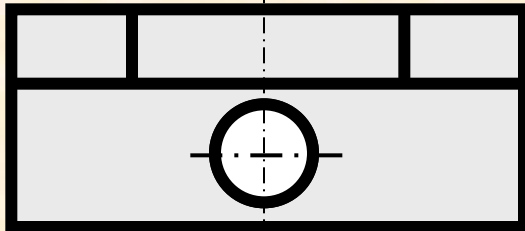
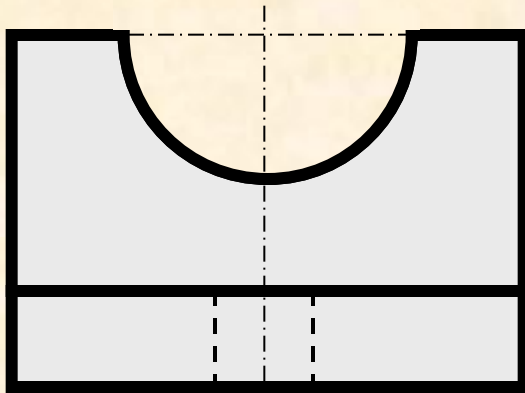

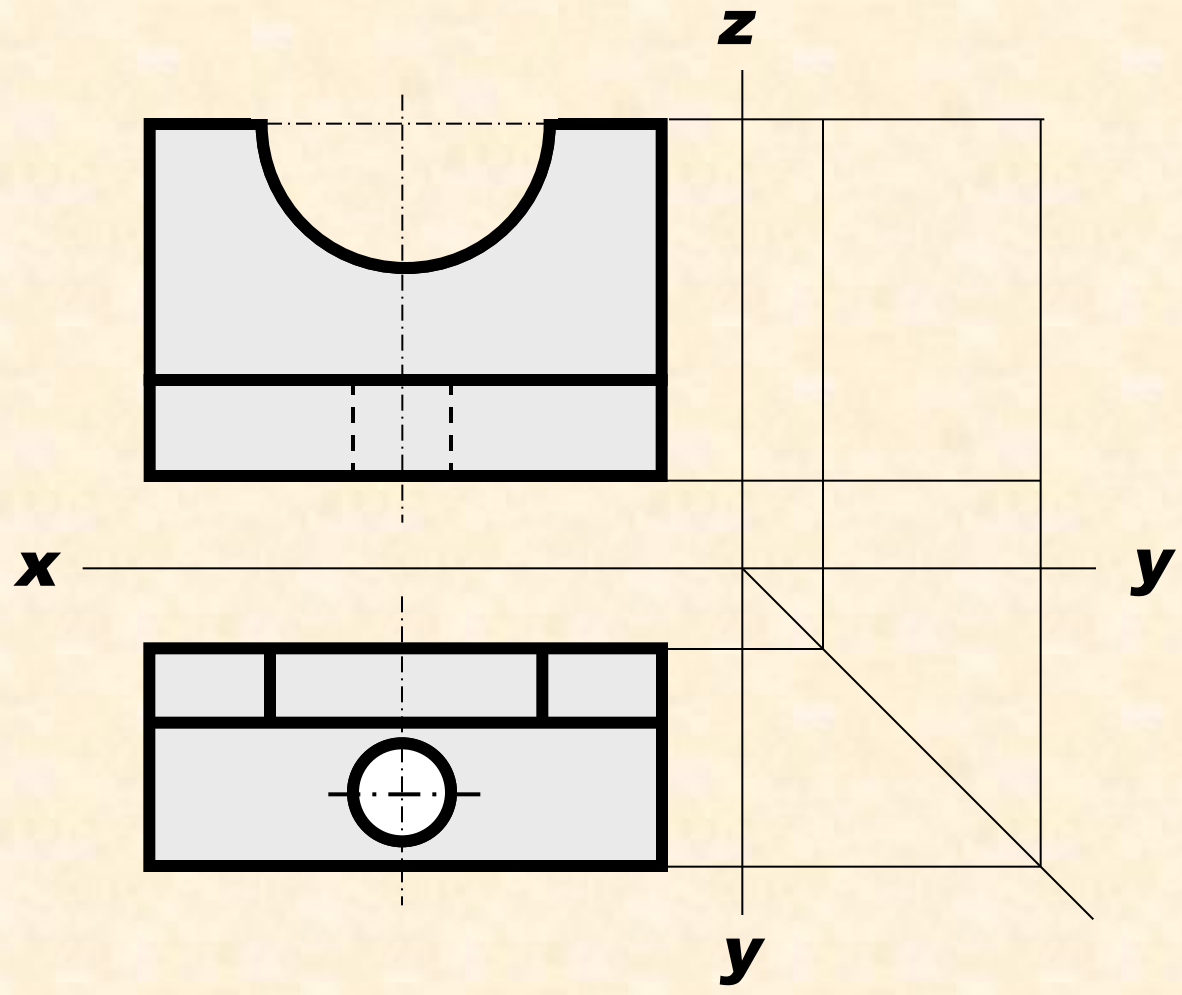

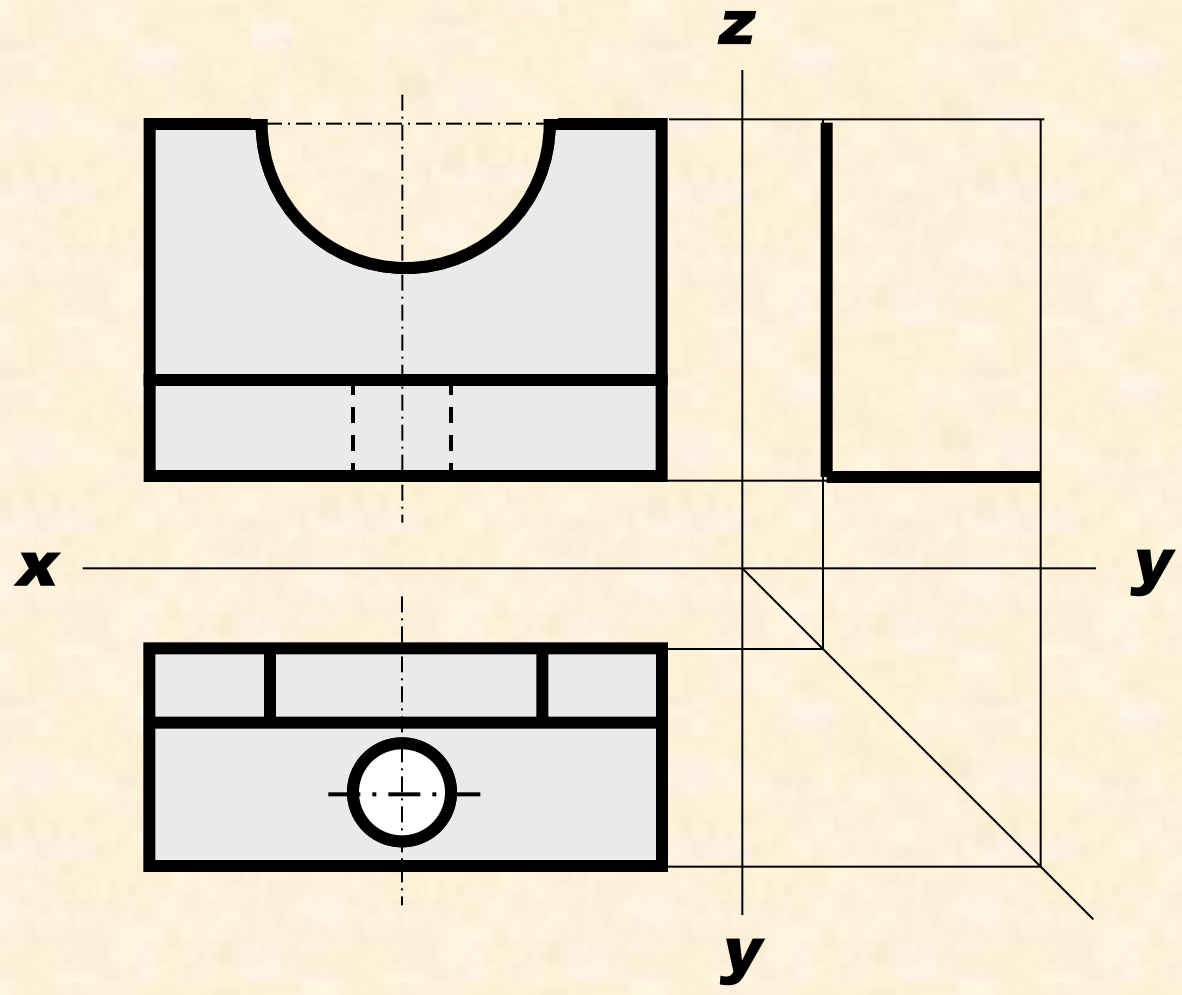

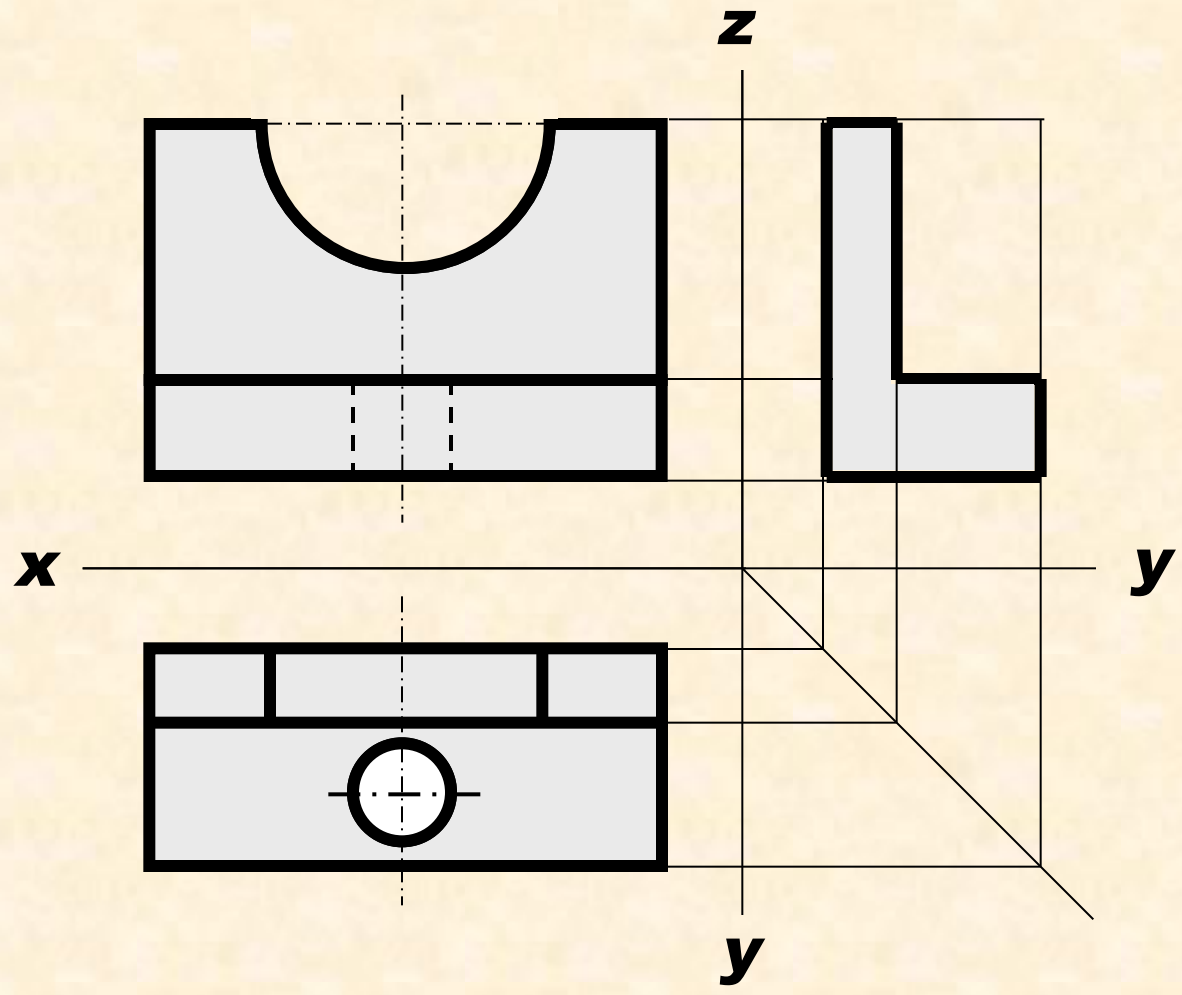

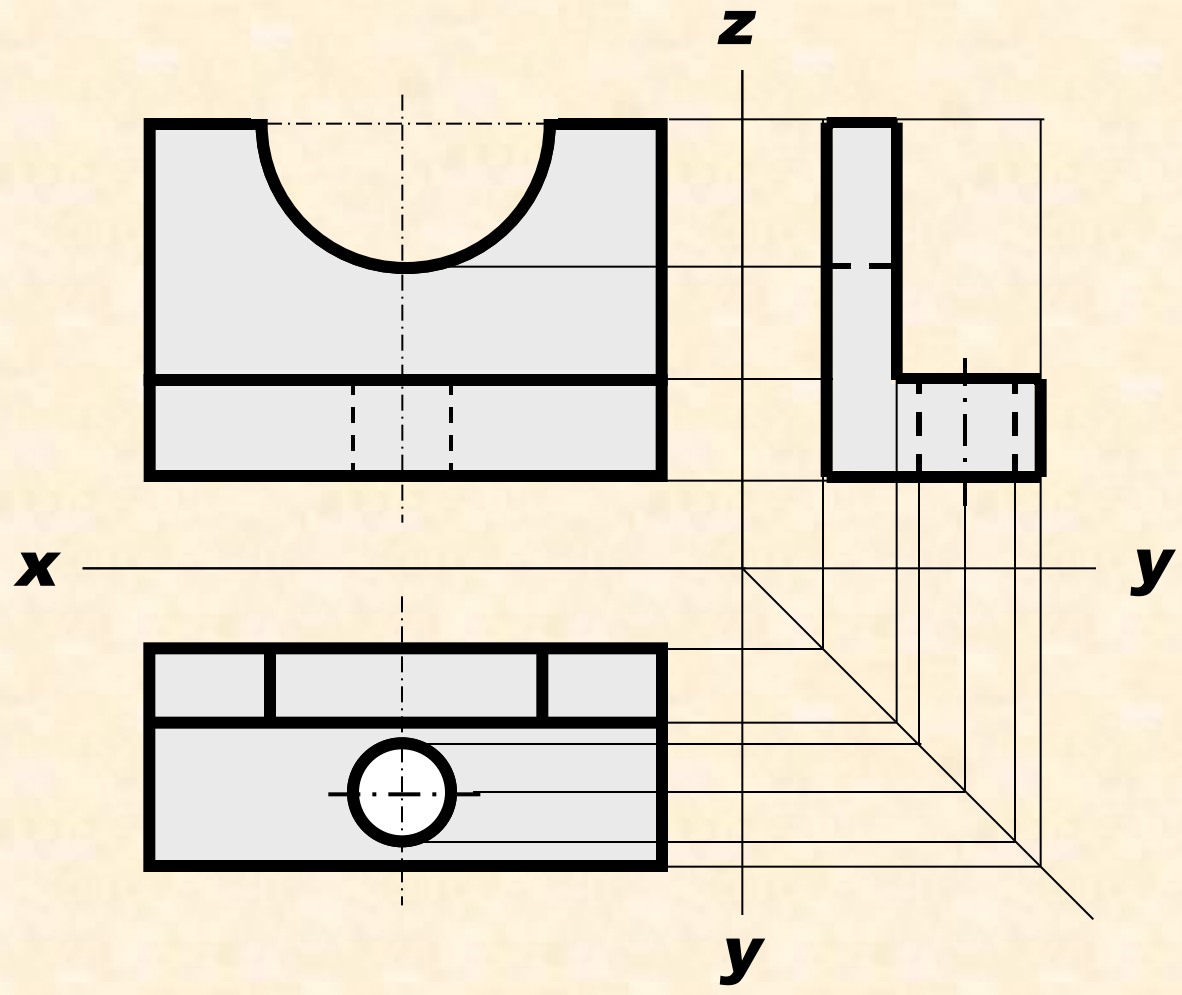

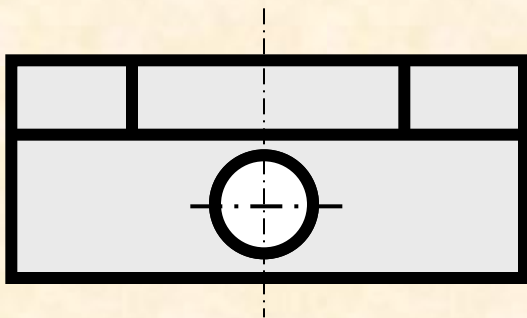
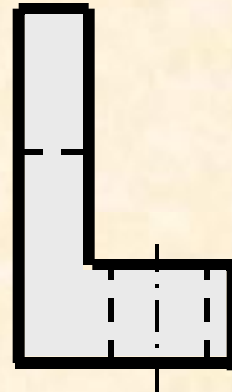
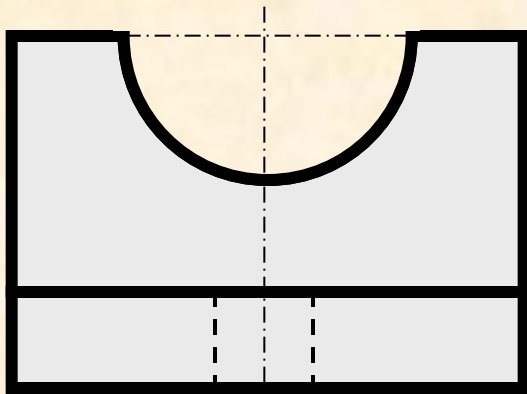

Построить третий вид

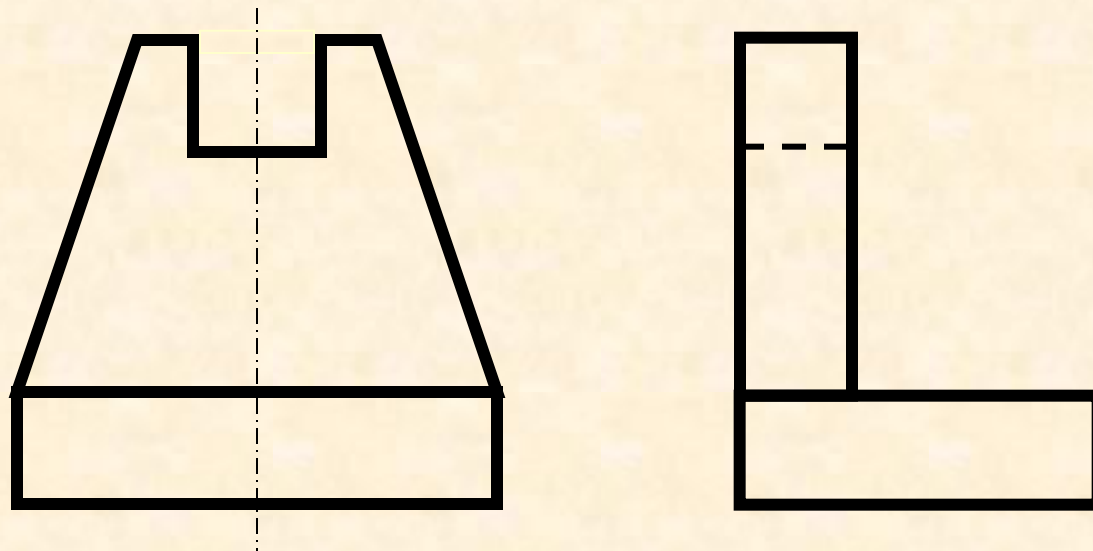

?

Построить третий вид

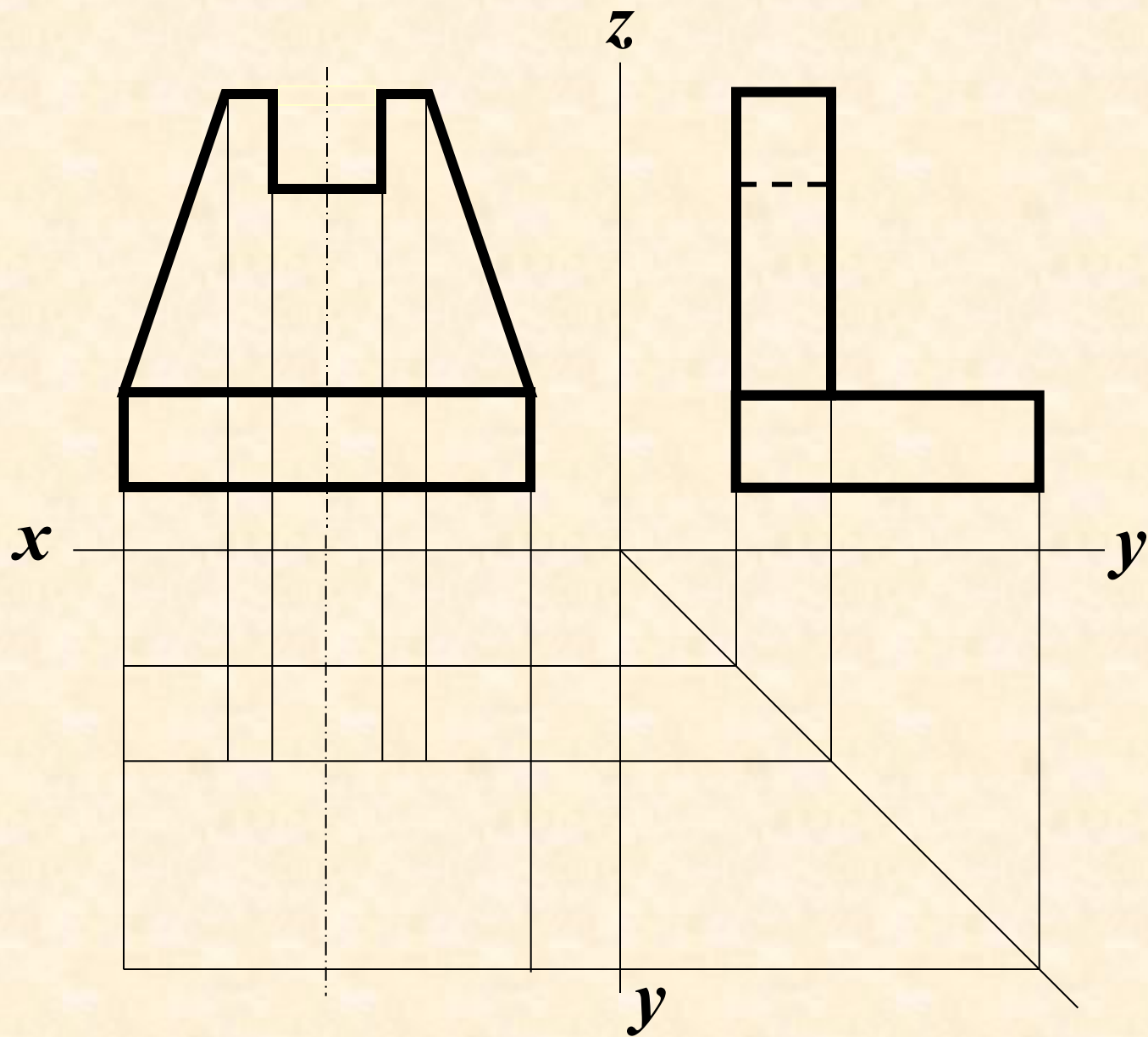

Построить третий вид

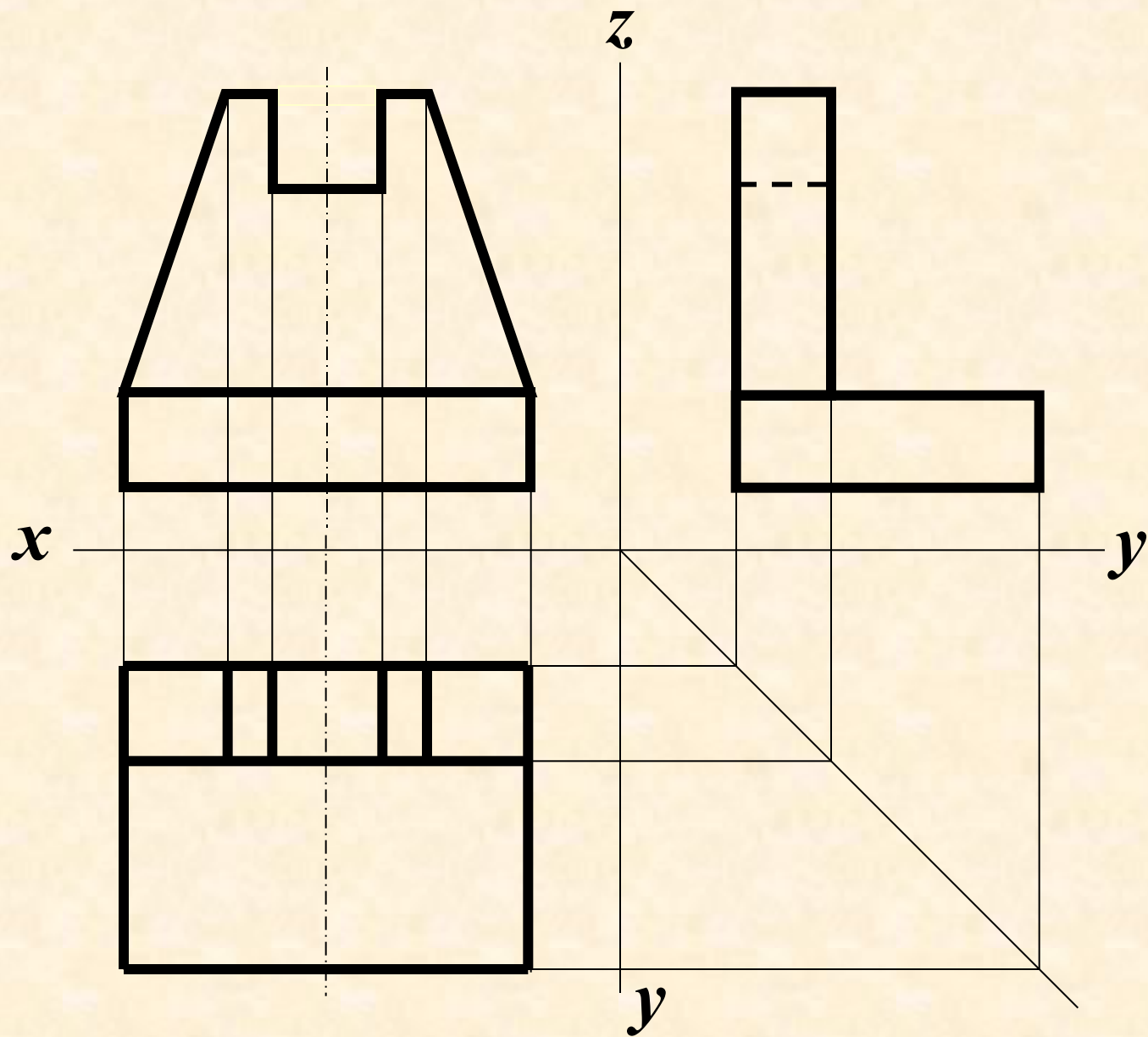

Построить третий вид

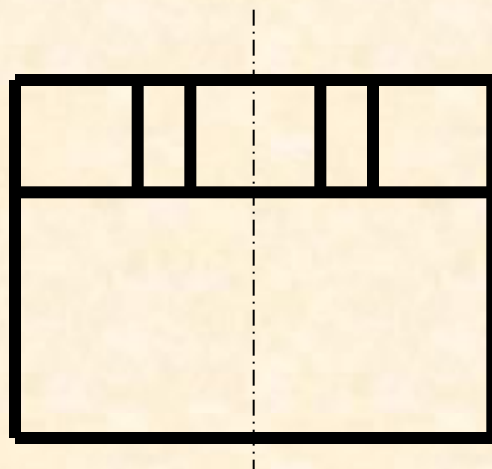
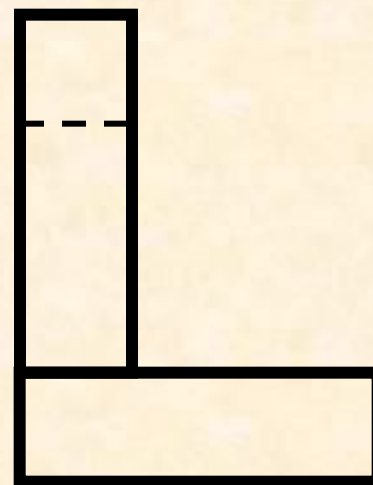
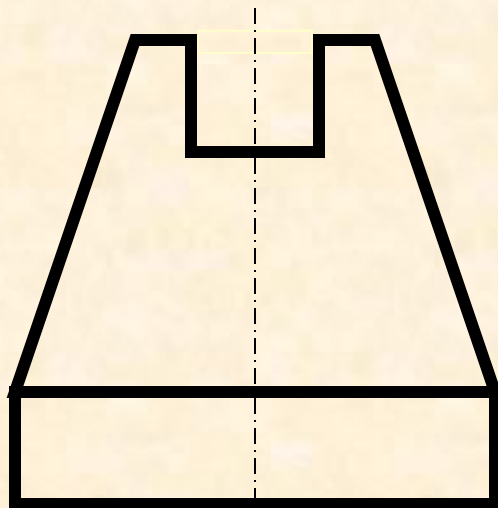

ДЕТАЛЬ

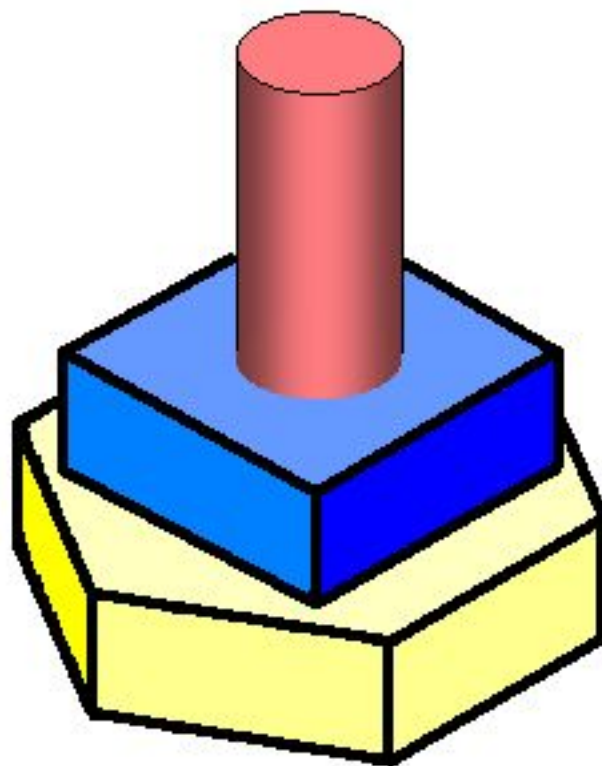

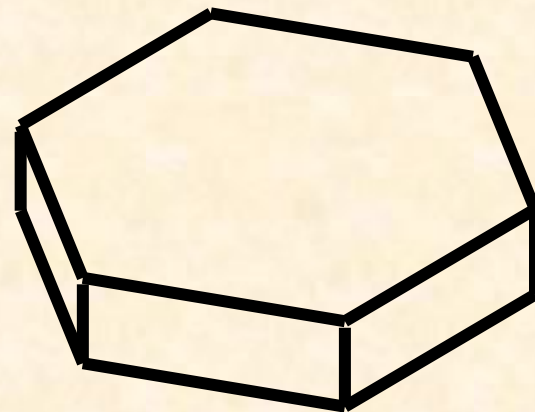
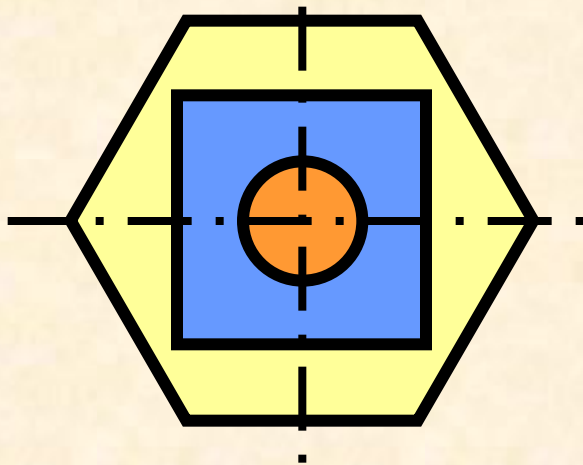
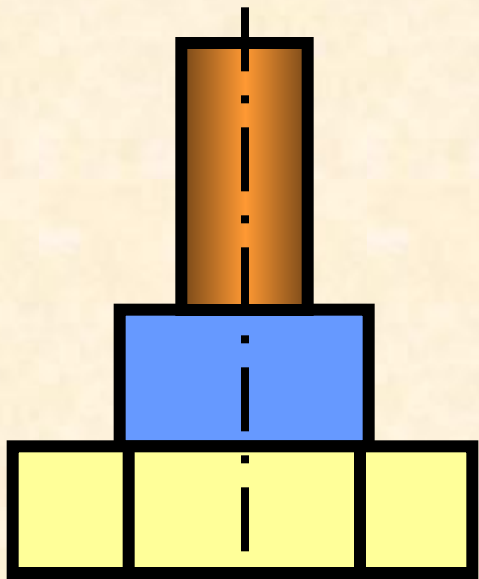

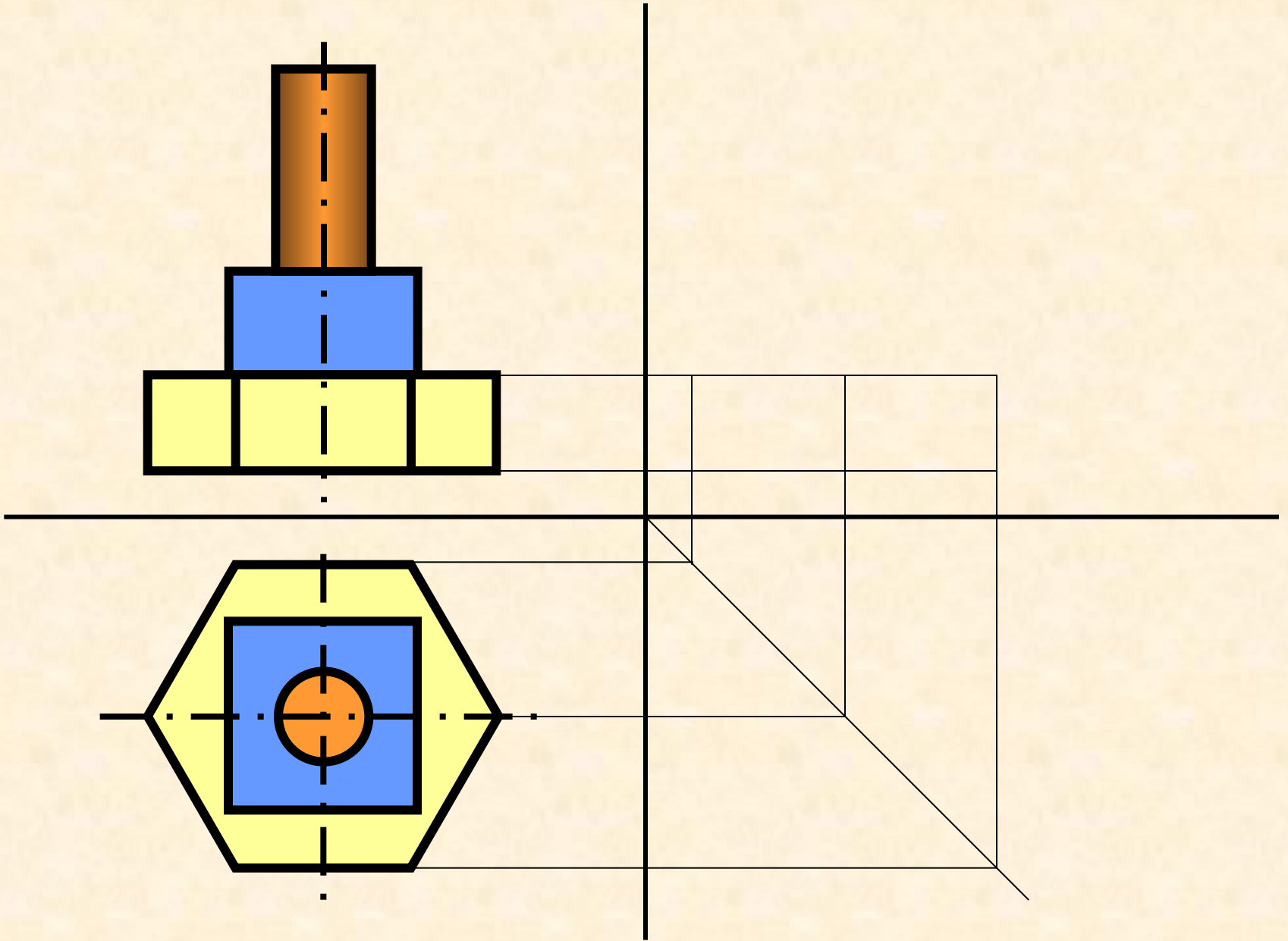

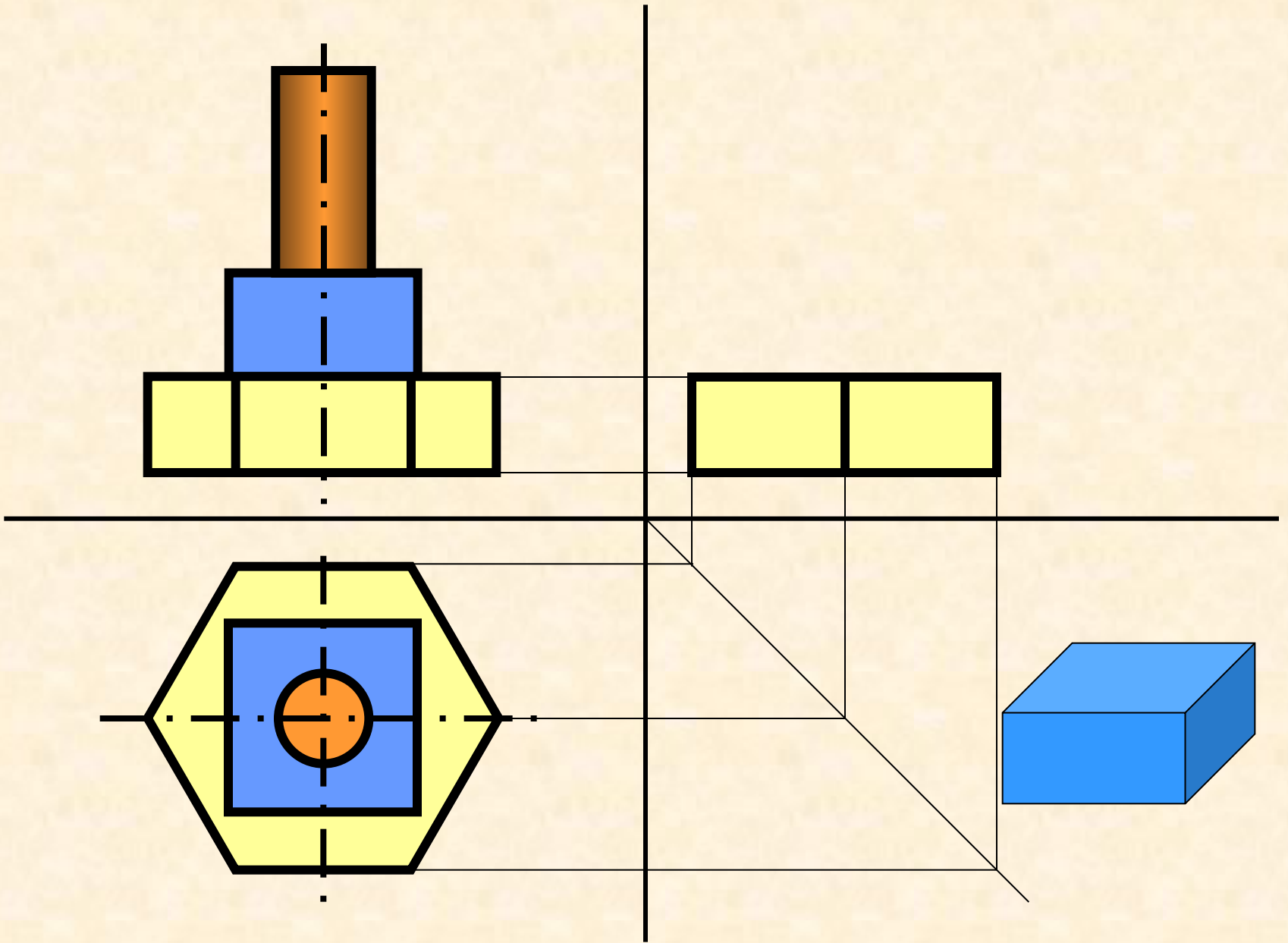

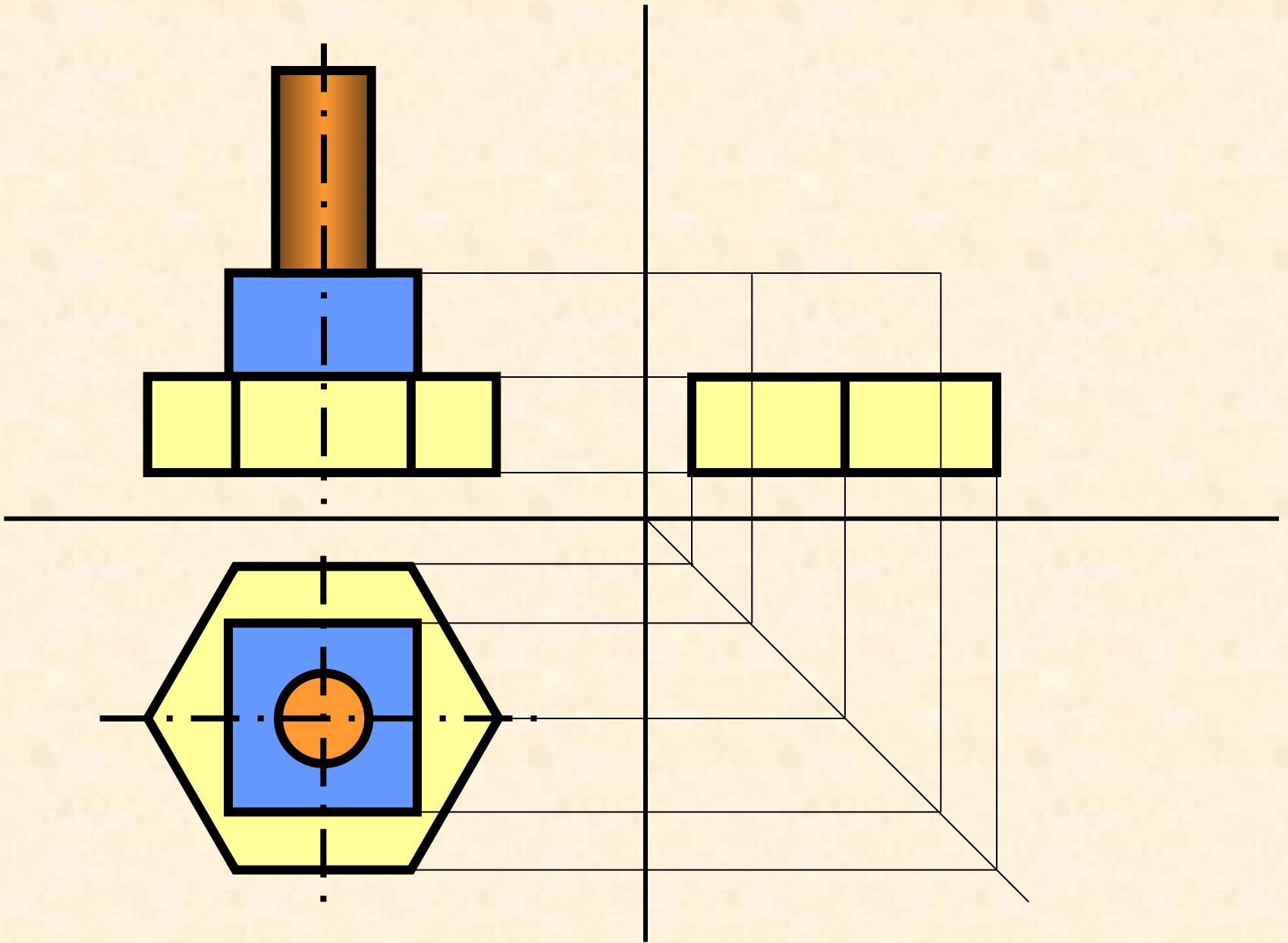

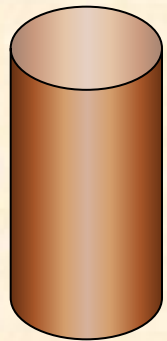
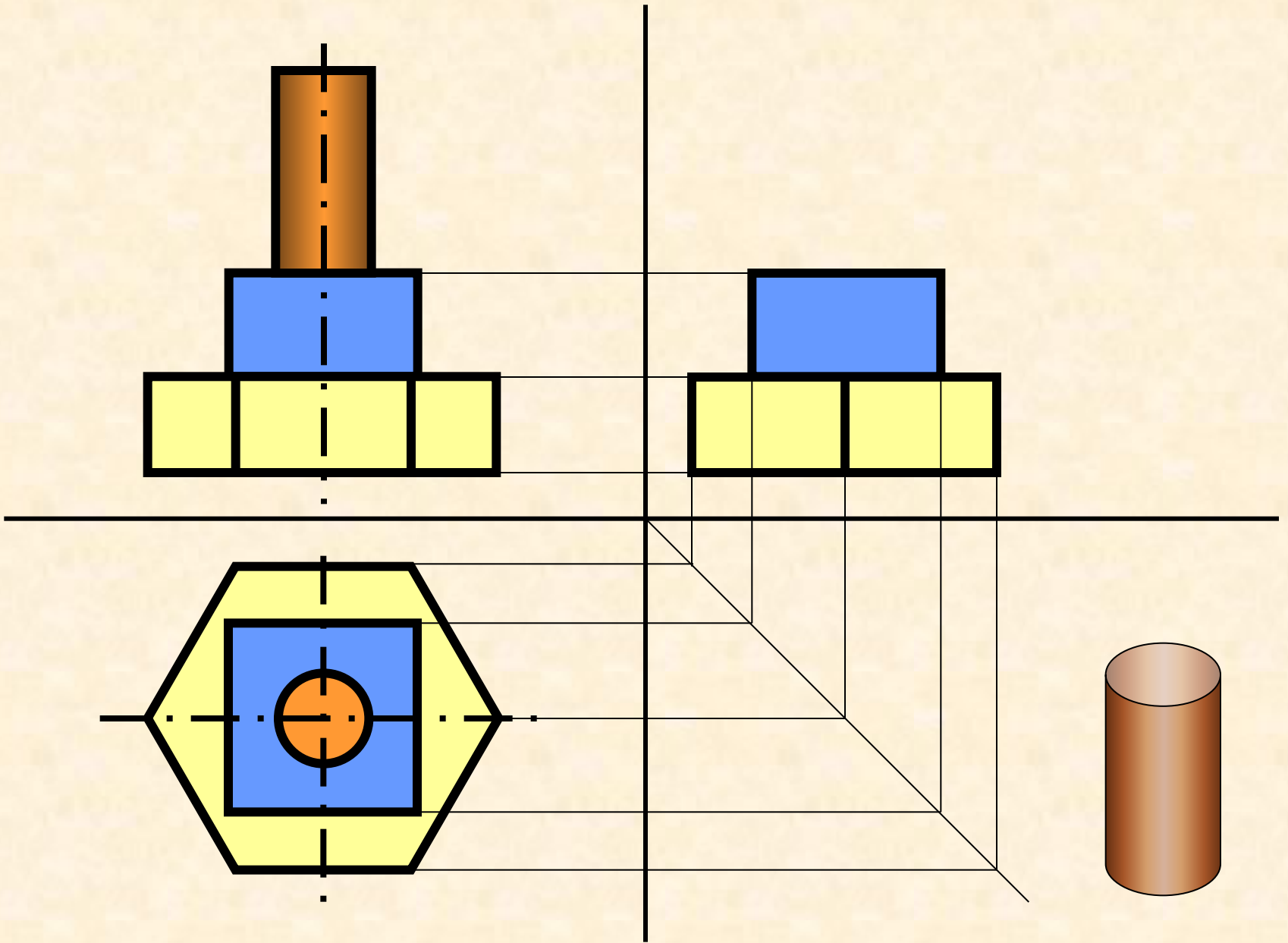

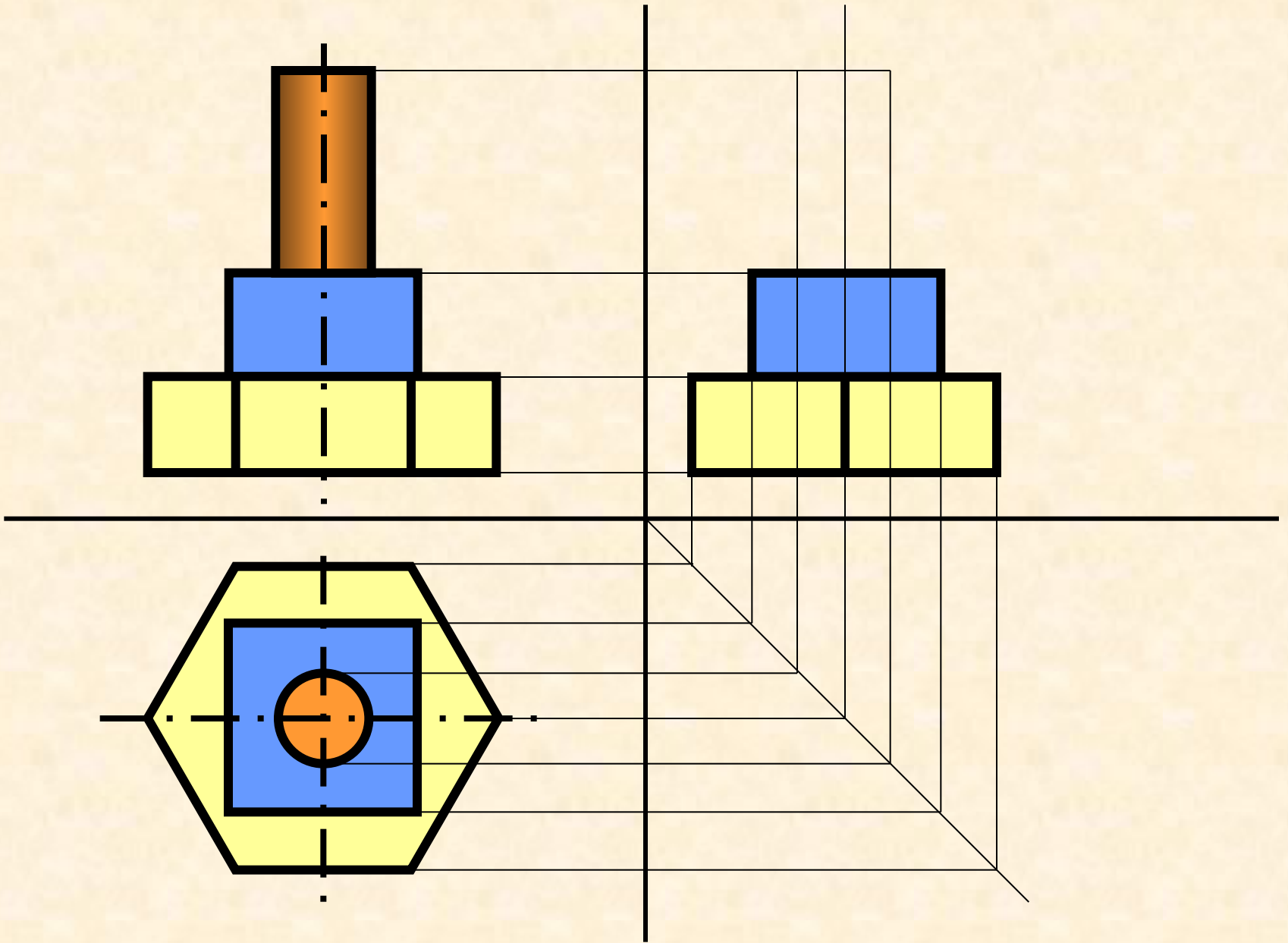

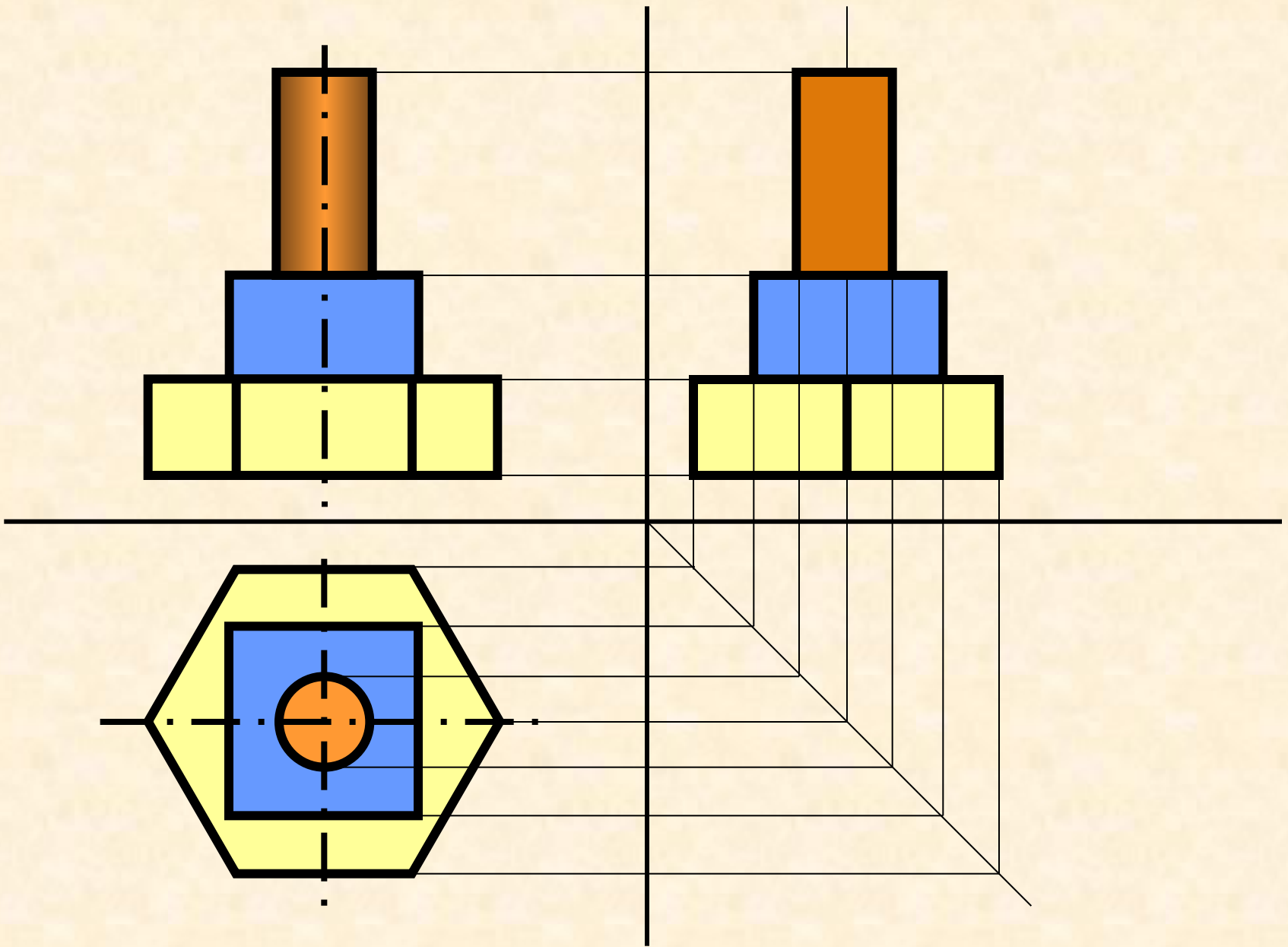

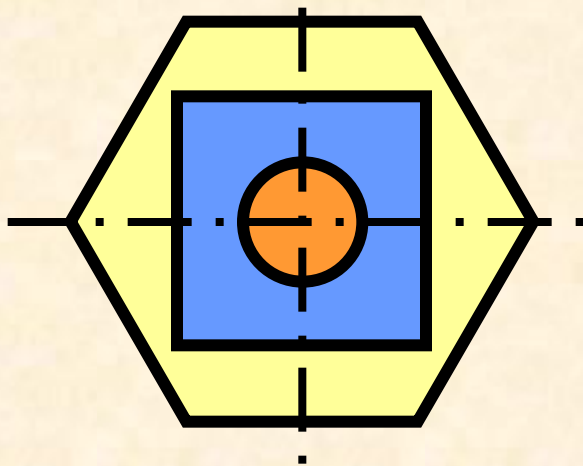
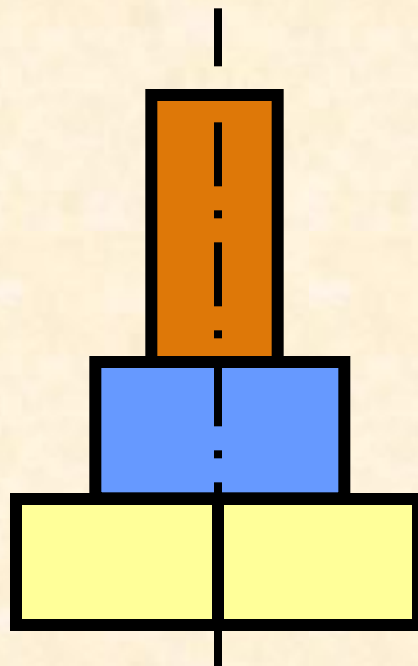
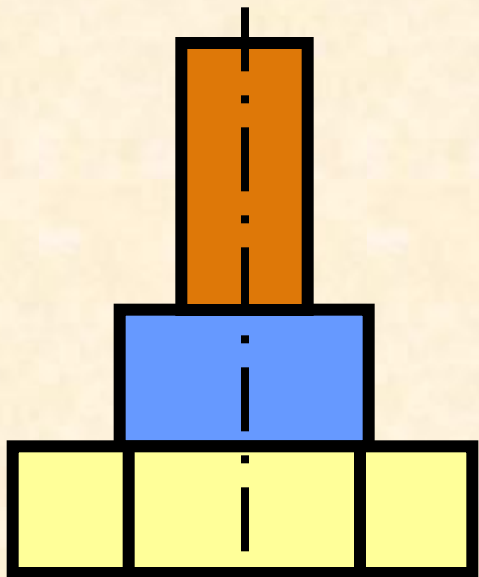

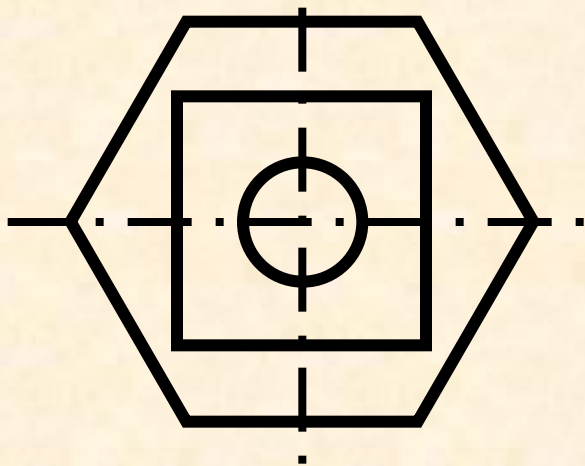
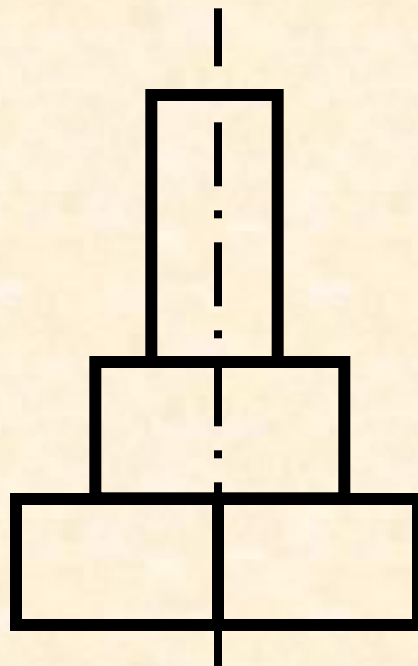
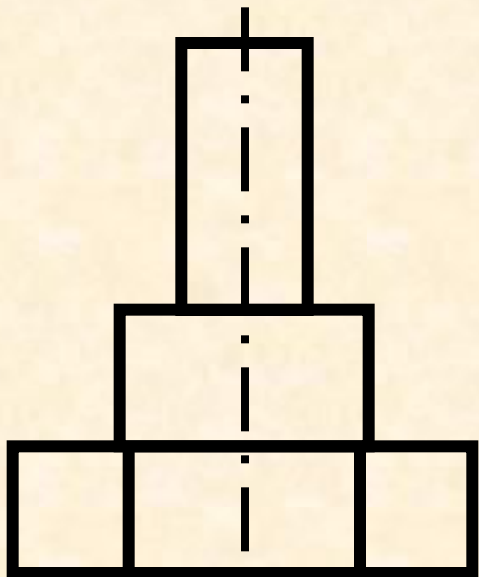

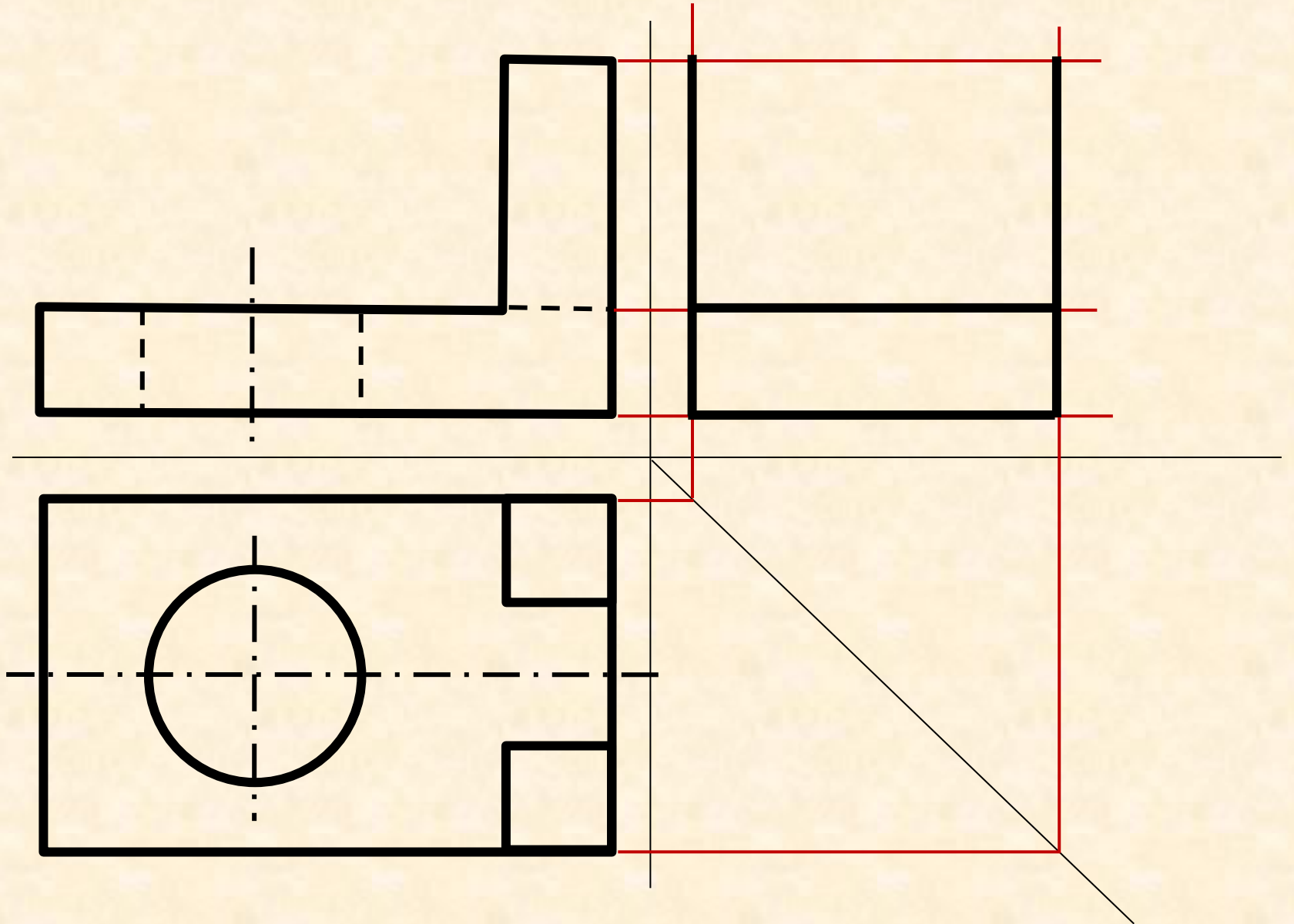

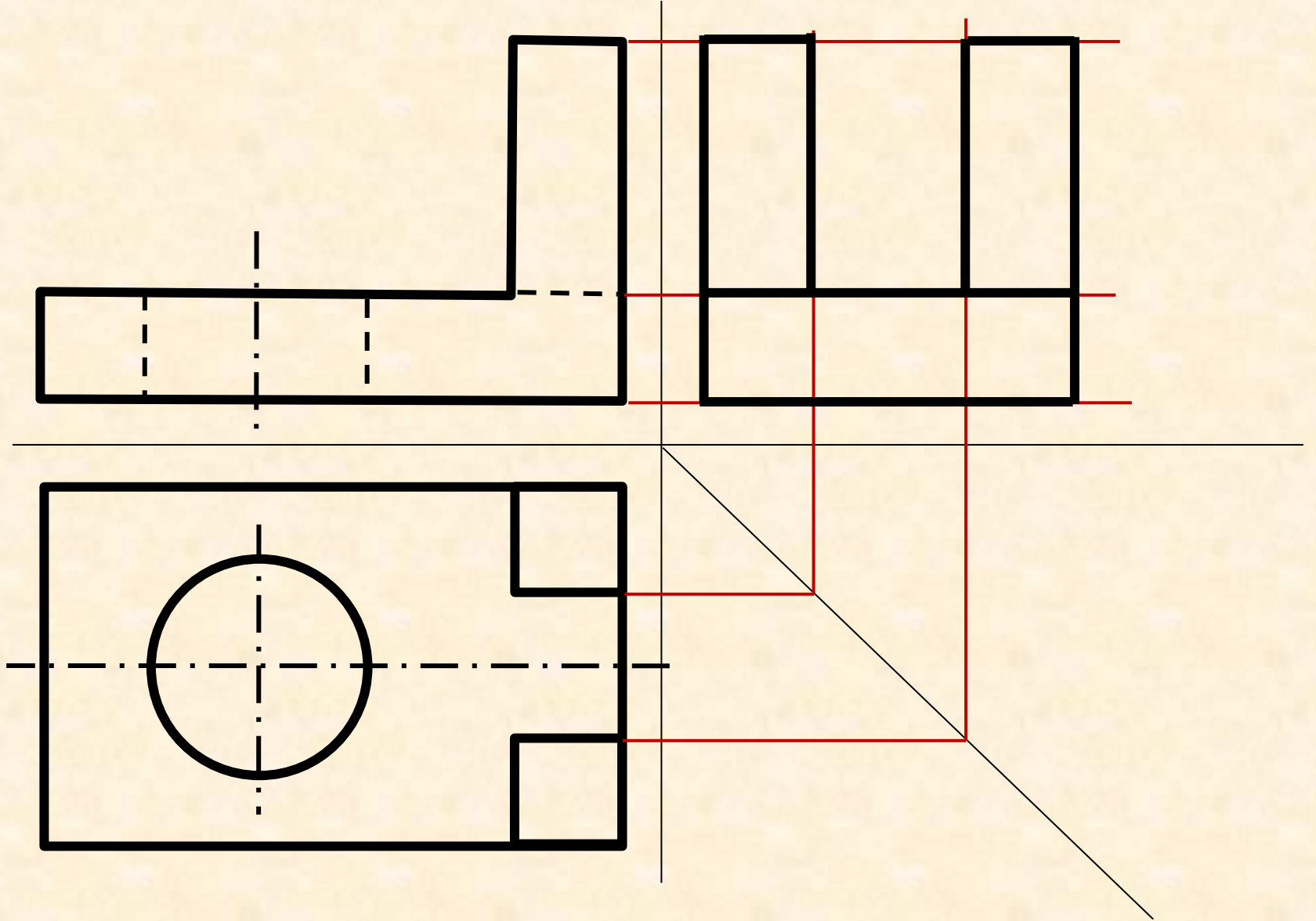

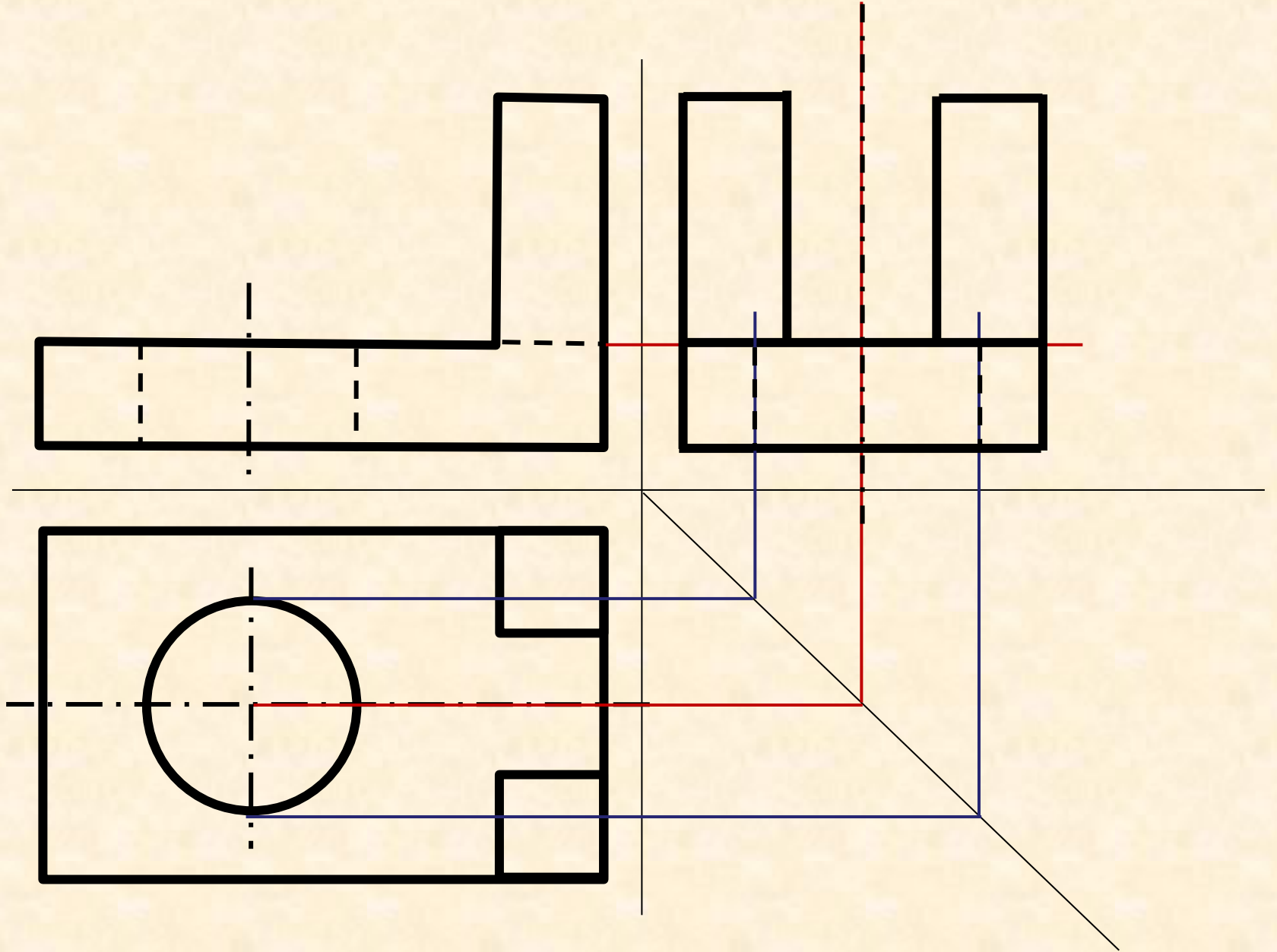

Построить третий вид

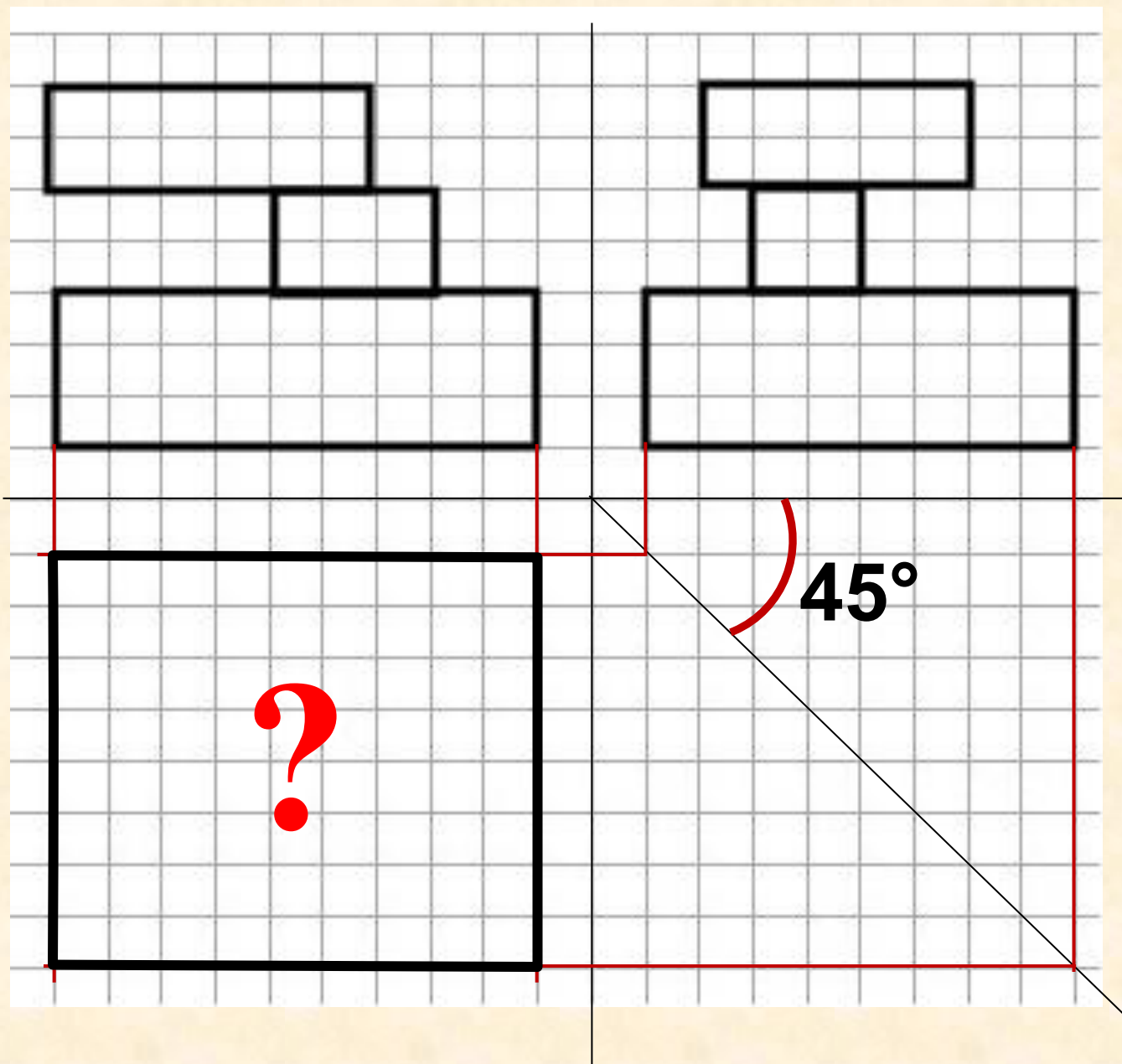

Построить третий вид

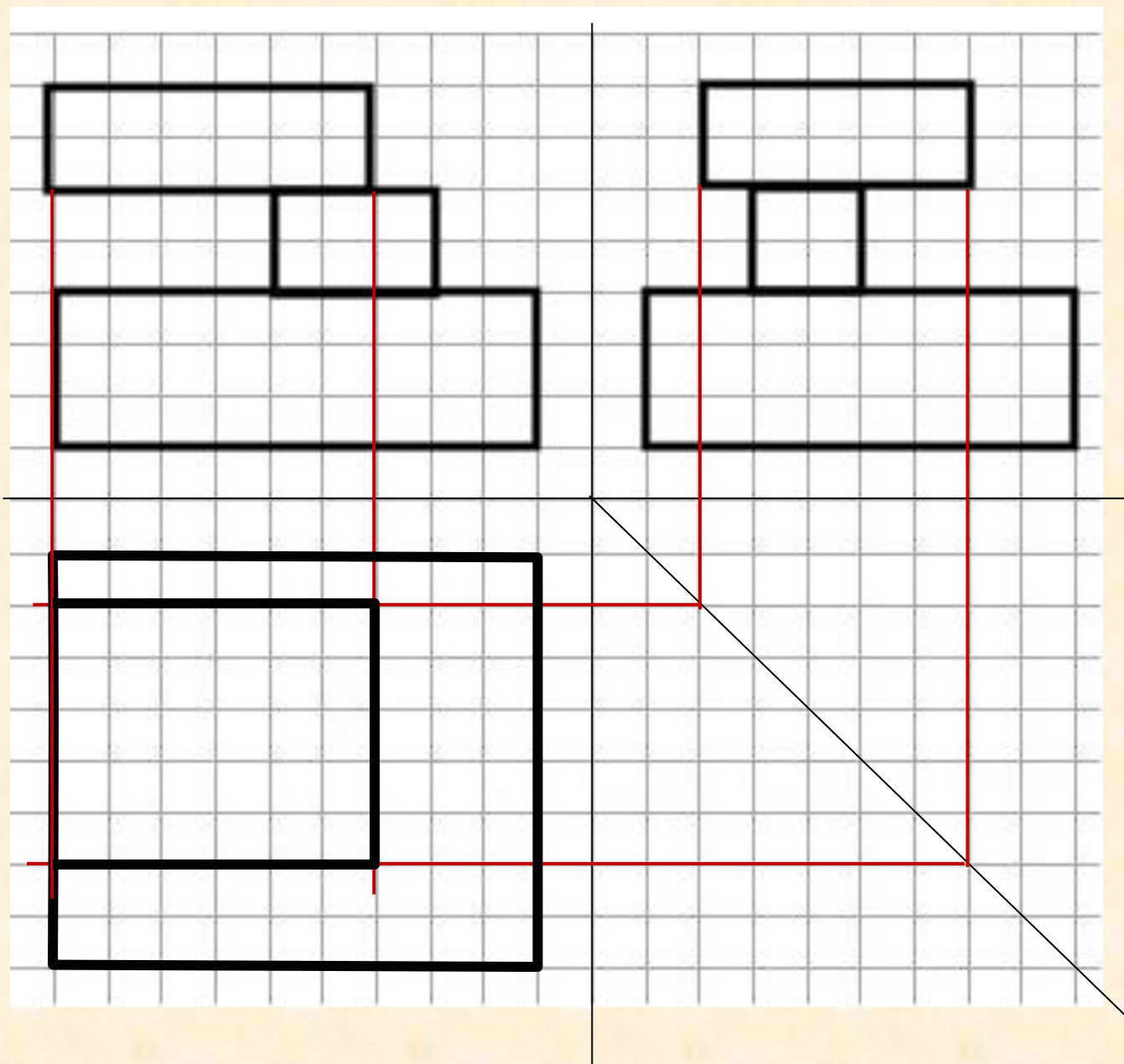

Построить третий вид

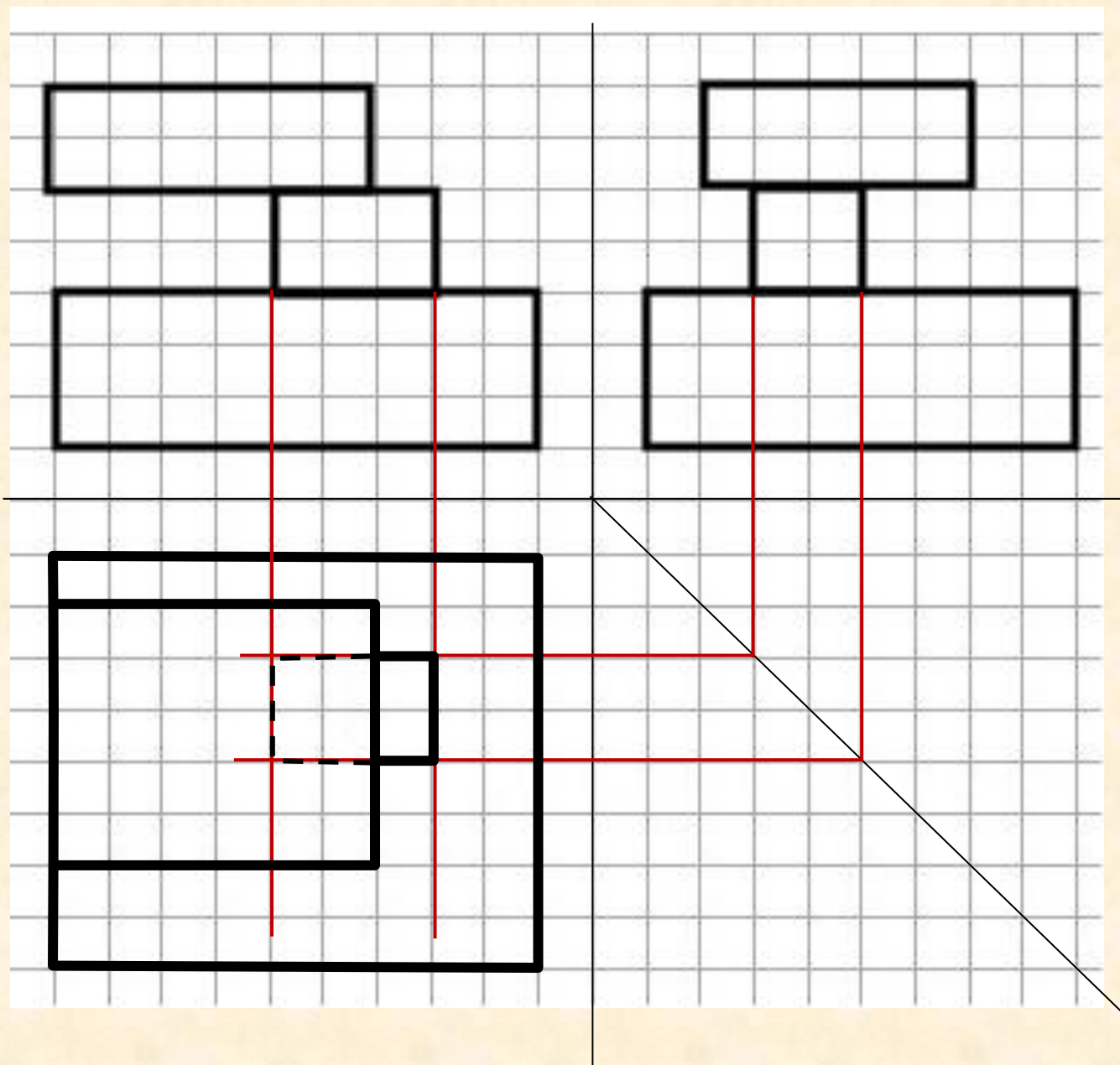

Построить третий вид

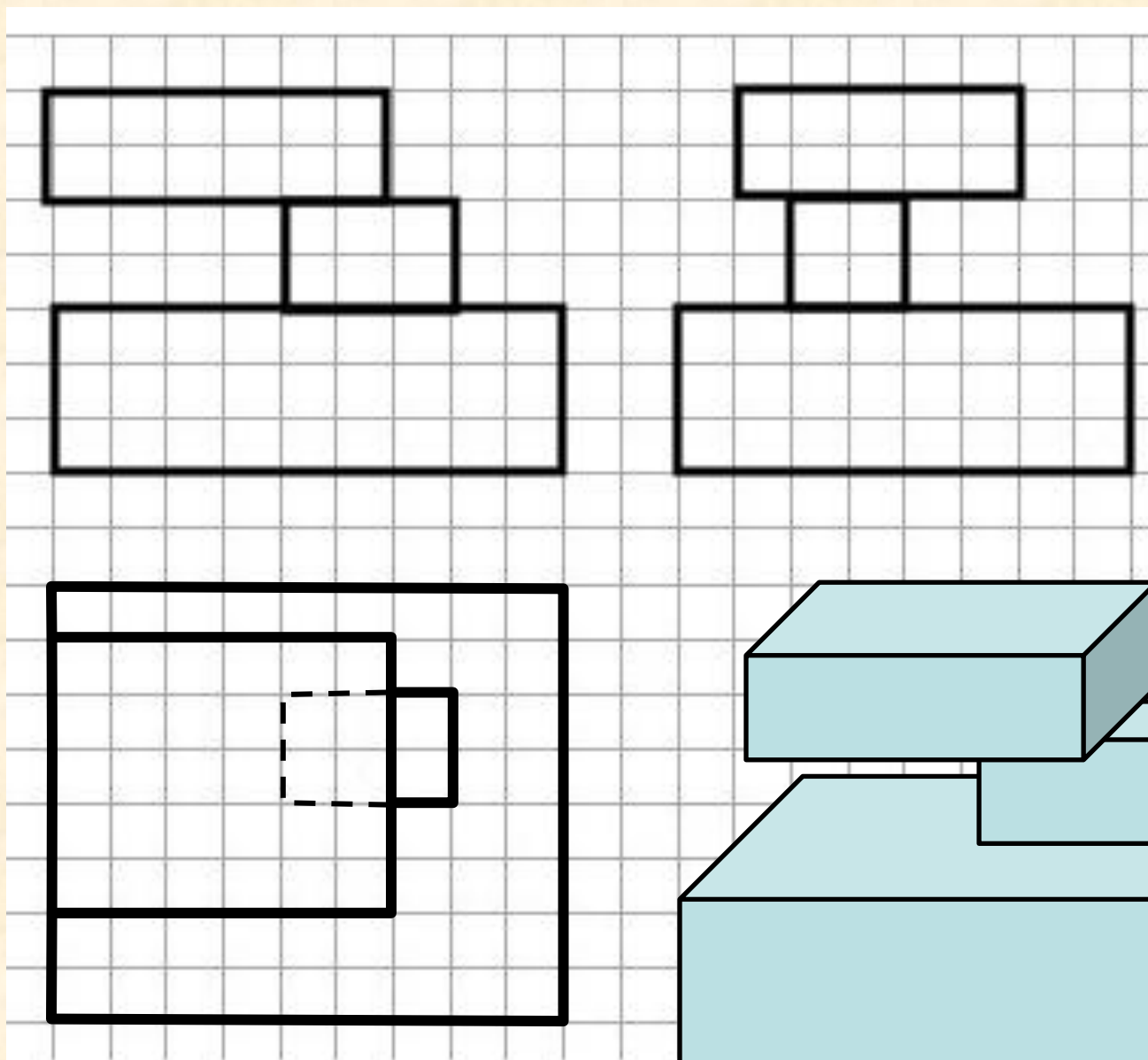

Построить третий вид

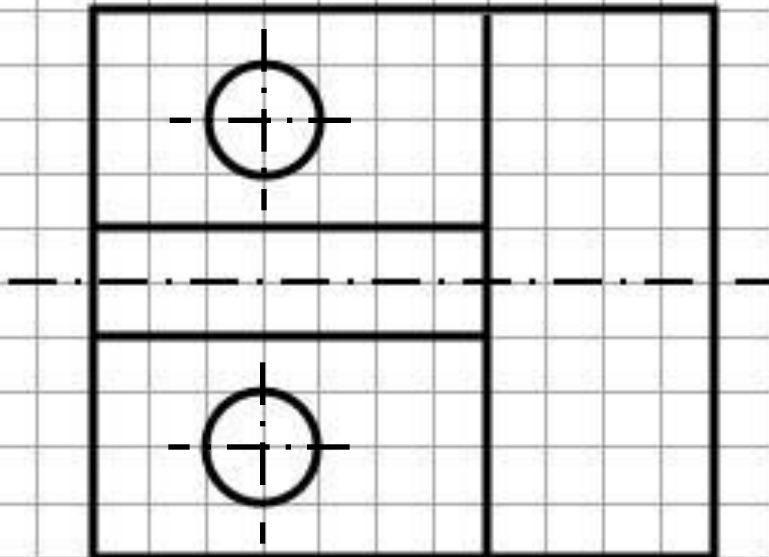
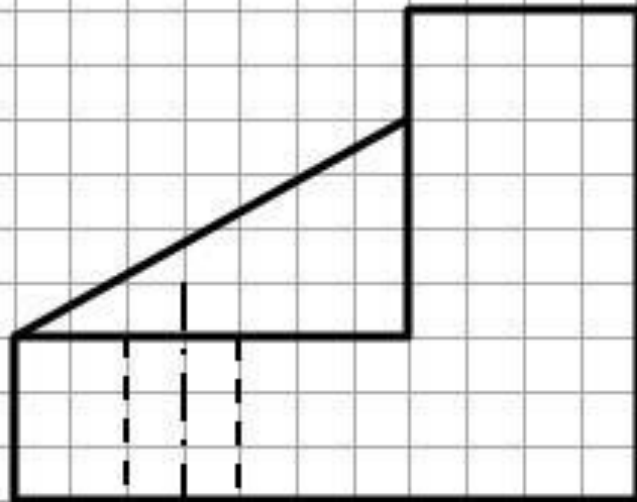

Построить третий вид

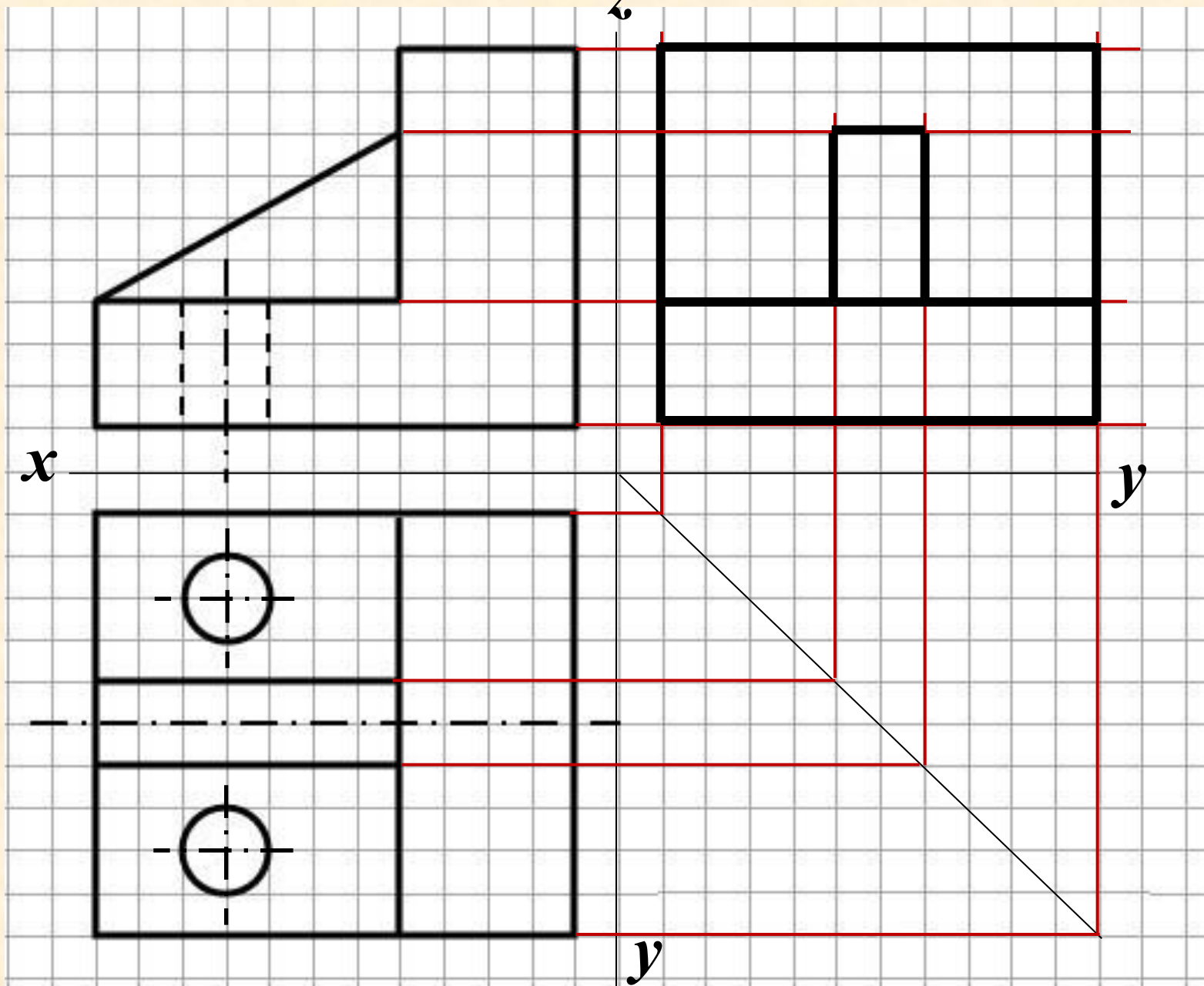

Построить третий вид

