



Hello Friends

# All About ME

Hello!

My name

is... Pete



I am... 9.

I live in.



I like...



I don't like



**7** Write **am, is** or **are**.

1 .....<sup>is</sup>..... it a bike?

3 ..... they lions?

5 ..... I slow?

7 ..... he a boy?

2 ..... you thirsty?

4 ..... we fast?

6 ..... she a queen?

8 ..... they rabbits?

# All About \_\_\_\_\_

I am

\_\_\_\_\_ years old.

This is me...

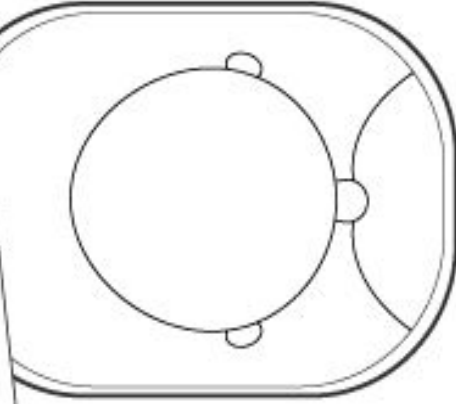

This is my family

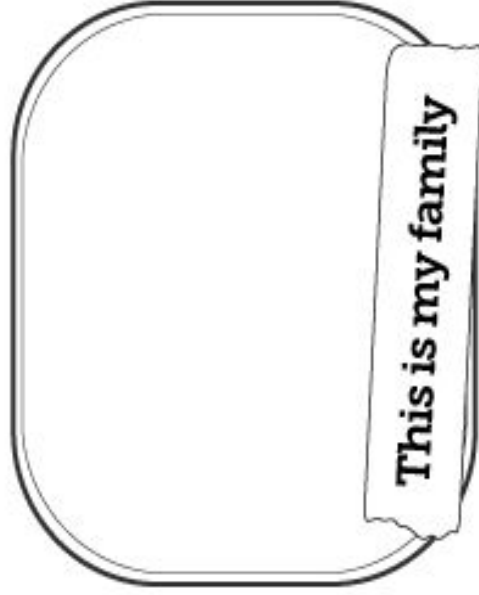

My favorite food is...



My Favorite color is...



I want to be...

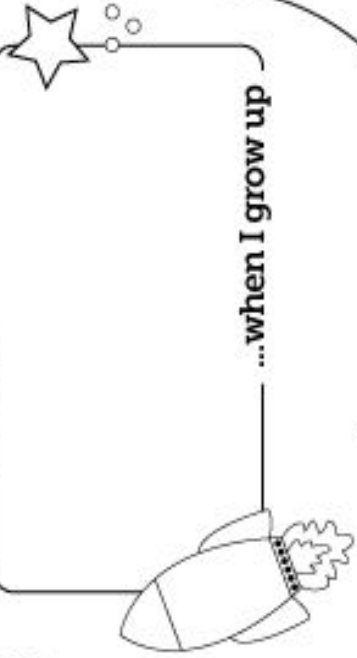

...when I grow up

I love...



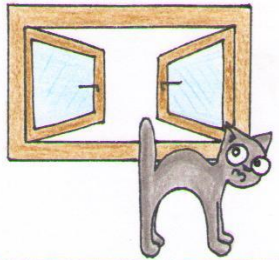

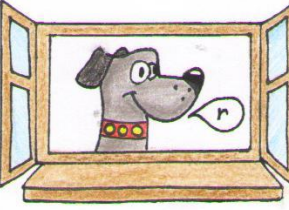
10	wh		why	/w/
----	----	--	-----	-----

11	wr		write	/r/
----	----	---	-------	-----

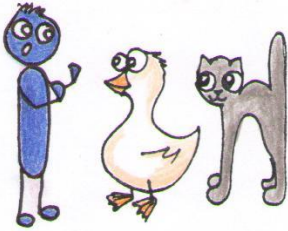
12	qu		queen	/kw/
----	----	---	-------	------

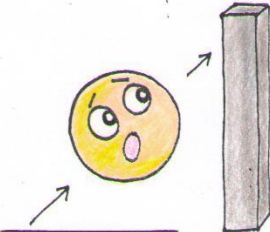
13	igh		high	/aI/
----	-----	--	------	------

14	al		ball	/ol/
----	----	---	------	------

5	sh		she	/ʃ/	III
---	----	--	-----	-----	-----

6	ch		chess	/tʃ/	Ч
---	----	---	-------	------	---

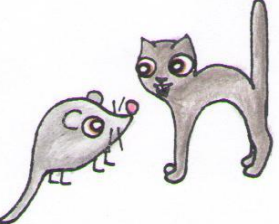
7	ph		photo	/f/	Ф
---	----	---	-------	-----	---

8	ck		black	/k/	К
---	----	--	-------	-----	---

9	ng		long	/ŋ/	НГ
---	----	---	------	-----	----

15

ai



Spain

/ eɪ /

эй

16

ay



day

/ eɪ /

эй

17

oi



point

/ oɪ /

ой

18

oy

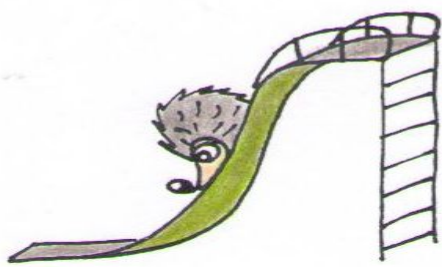

boy

/ oɪ /

ой

19

19

ow

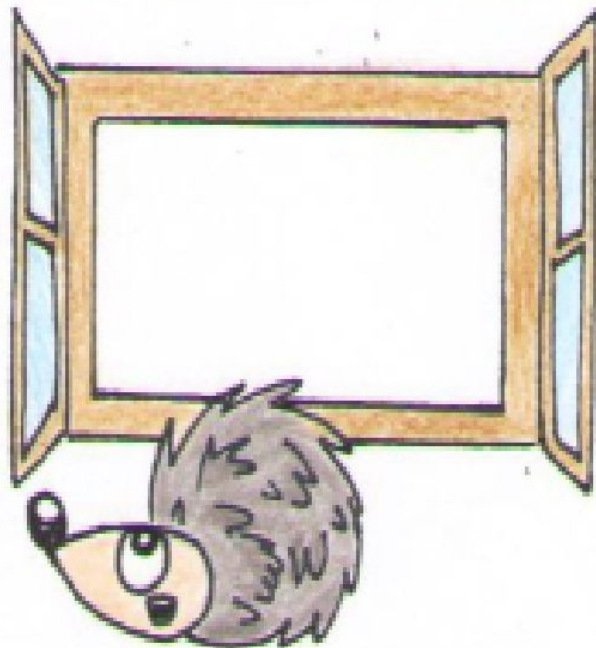

brown

/ au /

oy

20

ou

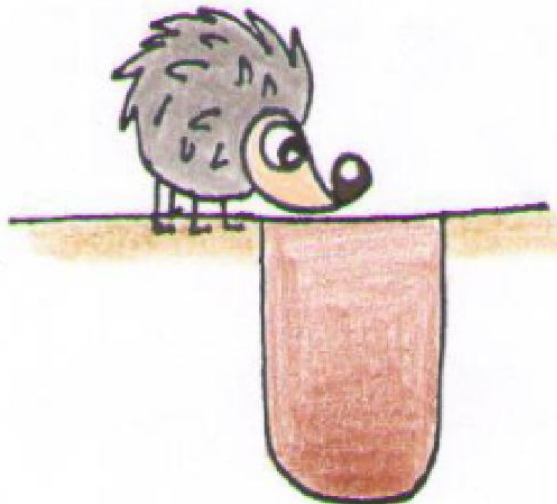

out

/ au /

o

# Make Your Own Bingo!

**ou**

**oi**

**ay**

**ai**

**ow**

**wr**

**oy**

**wh**

**qu**





# DANCE



**READING  
IS COOL**

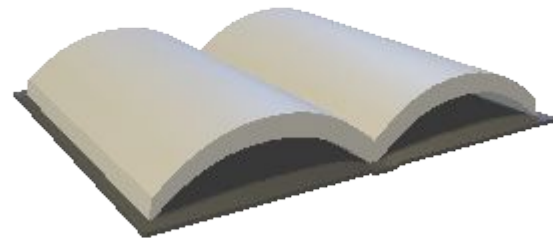

Andy sees ten rabbits in the zoo.  
What can ten rabbits do?

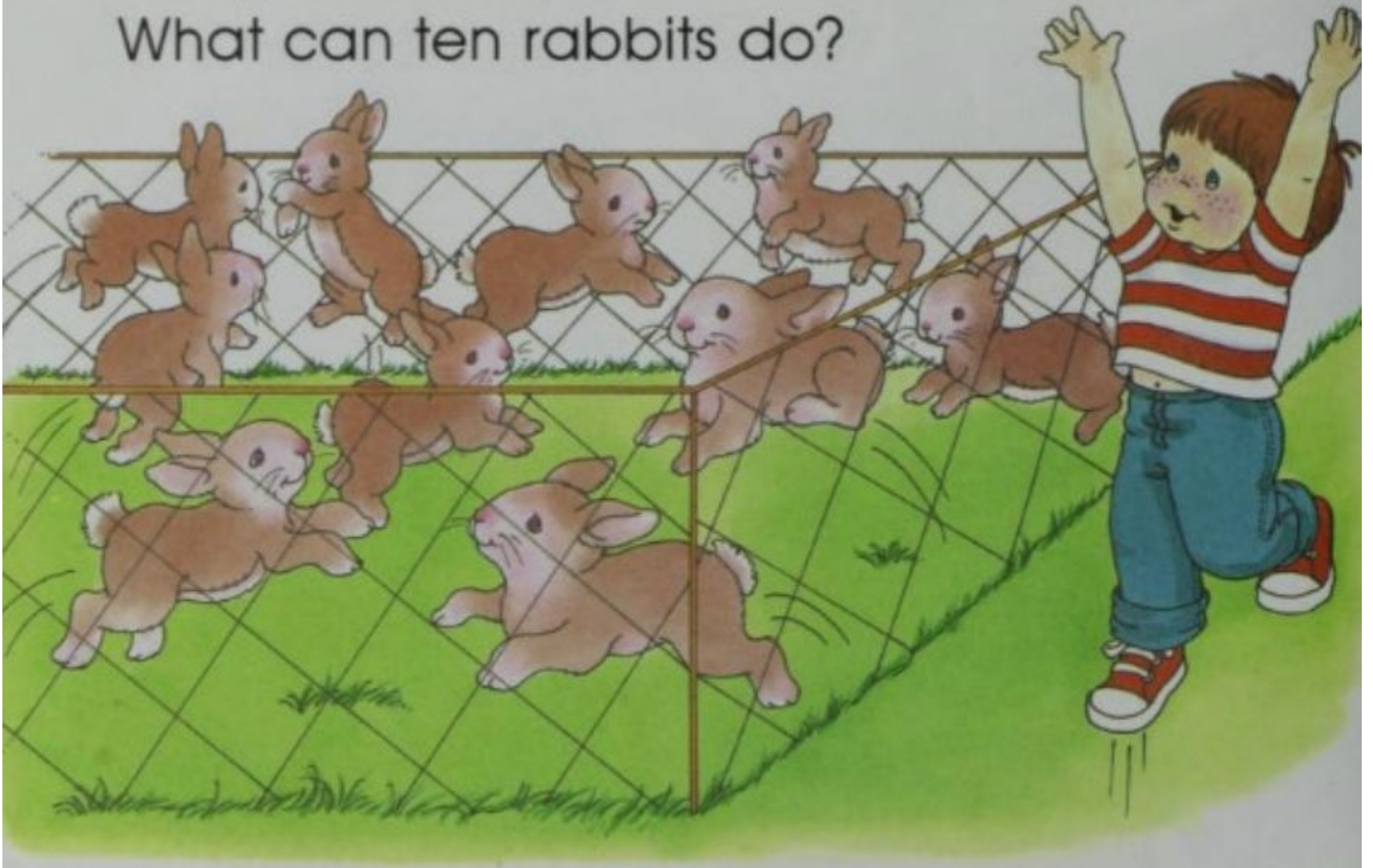

They can hop, hop, hop. Then they can stop. Andy can do that too. Can you?

Then Andy sees his friend, Ann,  
at the ice-cream stand.



What do the two friends do?



They eat ice cream. They count to ten.



Then Ann hops, skips, jumps through the zoo again. And Andy closes the Word Window.

# Let's watch a cartoon



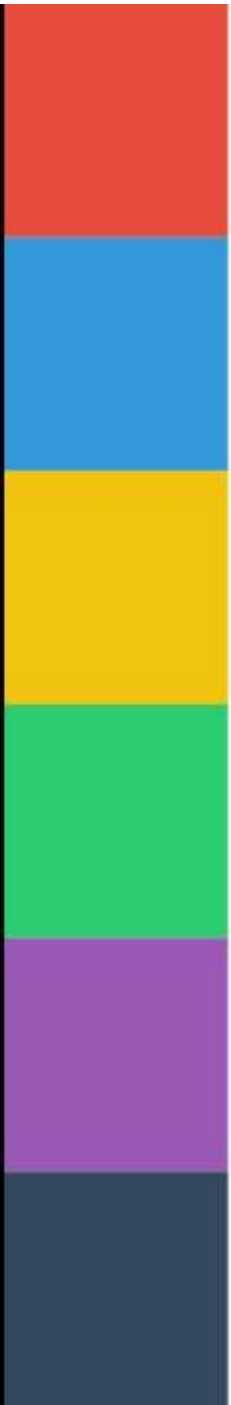





**chair**



**table**



**bowl**

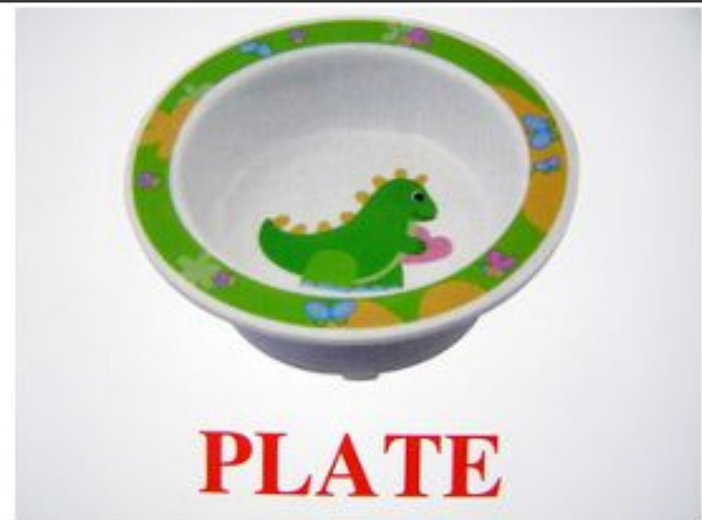

**plate**



**mug**

NEW ACROSS



**knife**



**fork**



**spoon**



**Lay the table.**



**Put the...**



**Very good.**



**Wash the...**

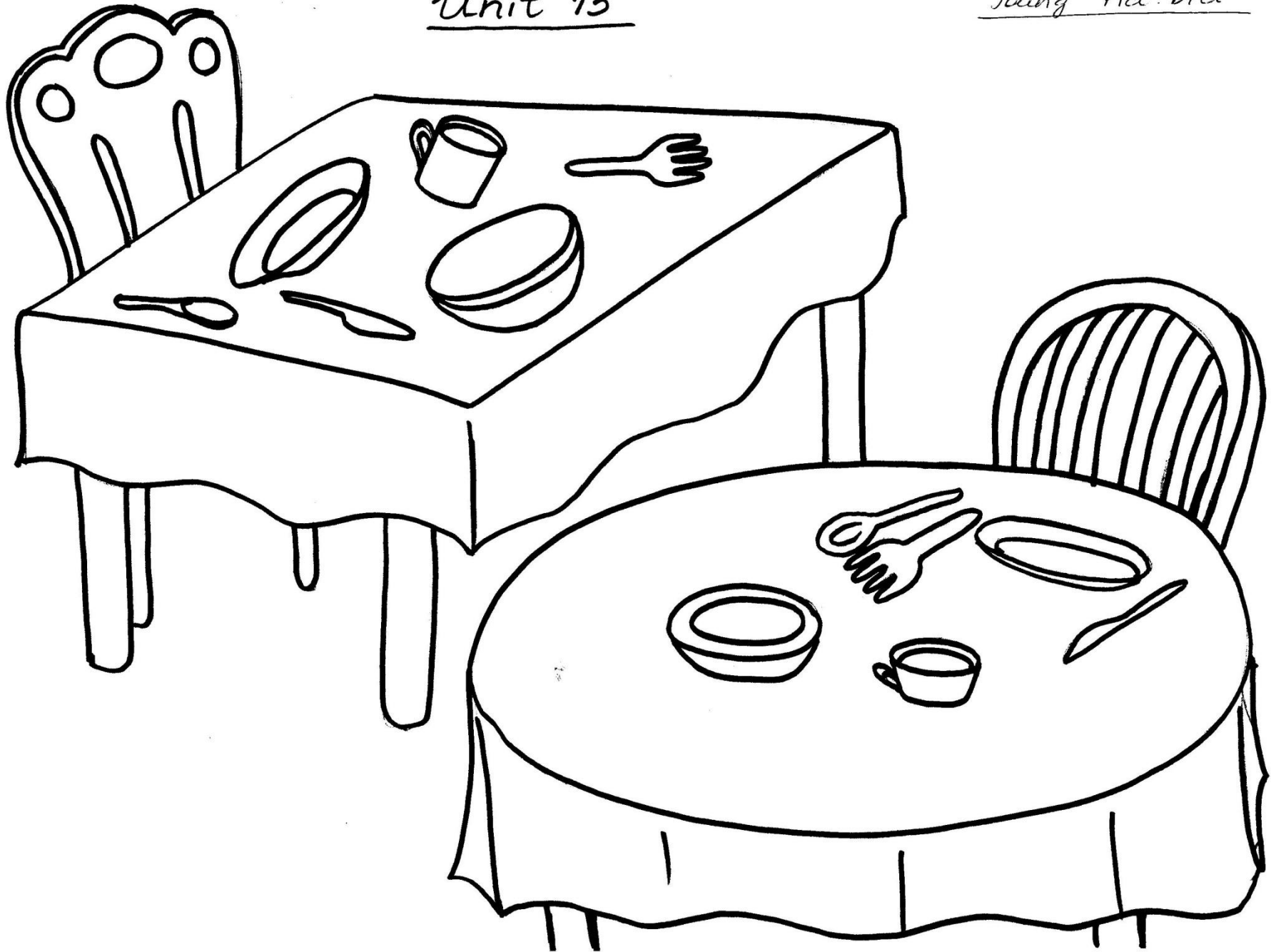

# Kitchen Chant

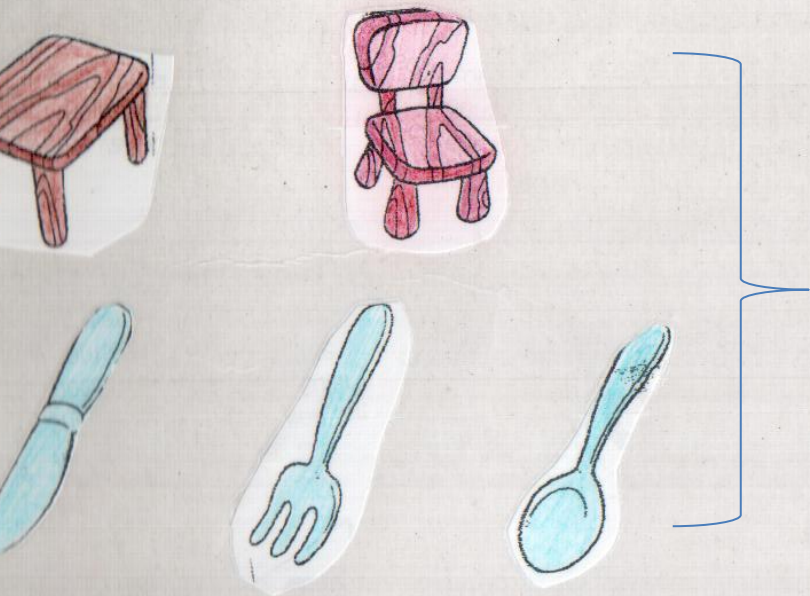

2

What's on the

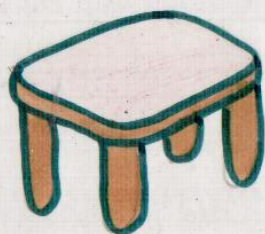

?

1 → a  
 2 → a  
 3 → a

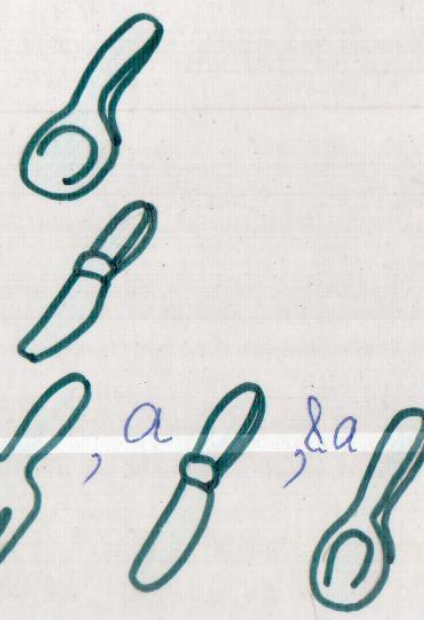



am I  
are you  
is he  
is she  
is it  
are we  
are you  
are they



happy?







## 6 Поставь предложения в вопросительную форму.

1 It is a crocodile.

Is it a crocodile?

---

2 He is Tony.

---

3 She is Anna.

---

4 It is a radio.

---

5 It is a classroom.

---

6 He is a teacher.

---

# GRAMMAR BALLOONS

*By Artem Morozou*

**START**





Hometask for 10.02:

- 1)
- 2)

Copy 13 B

Copy (to be)

# 13B In the Kitchen

 Trace the letters. Match.

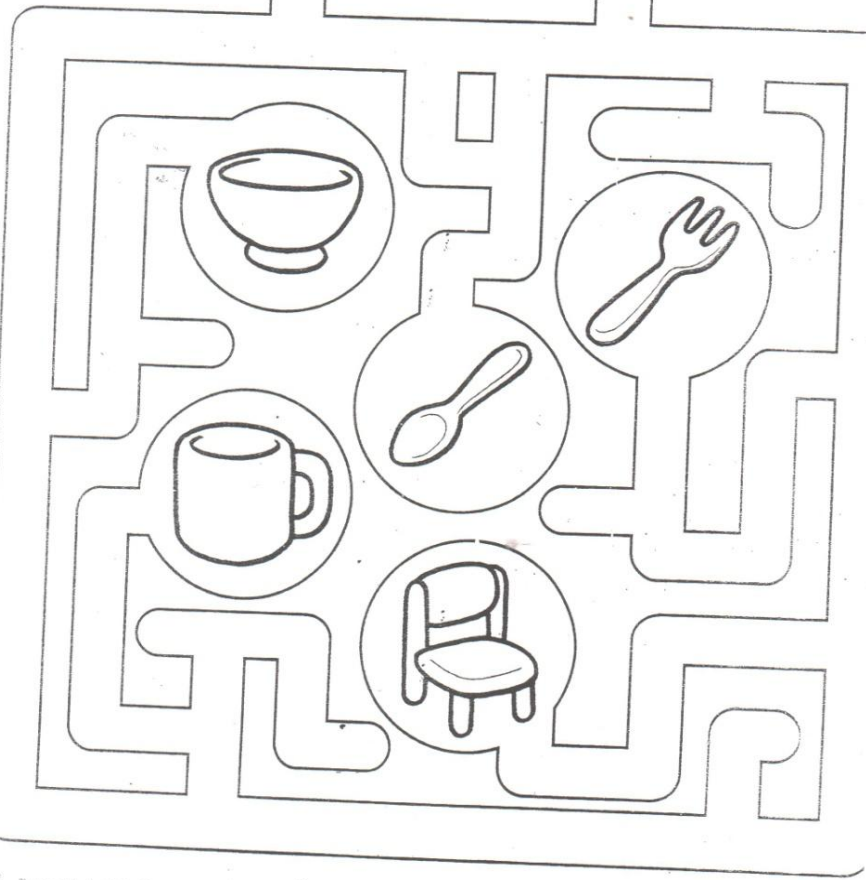
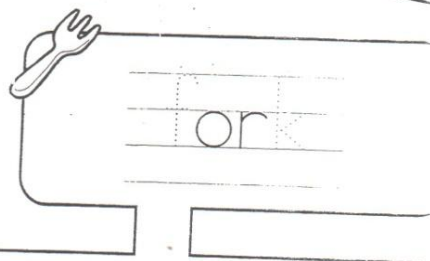
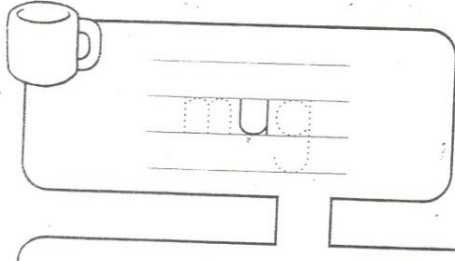

# 13B In the Kitchen

 Trace the letters. Match.

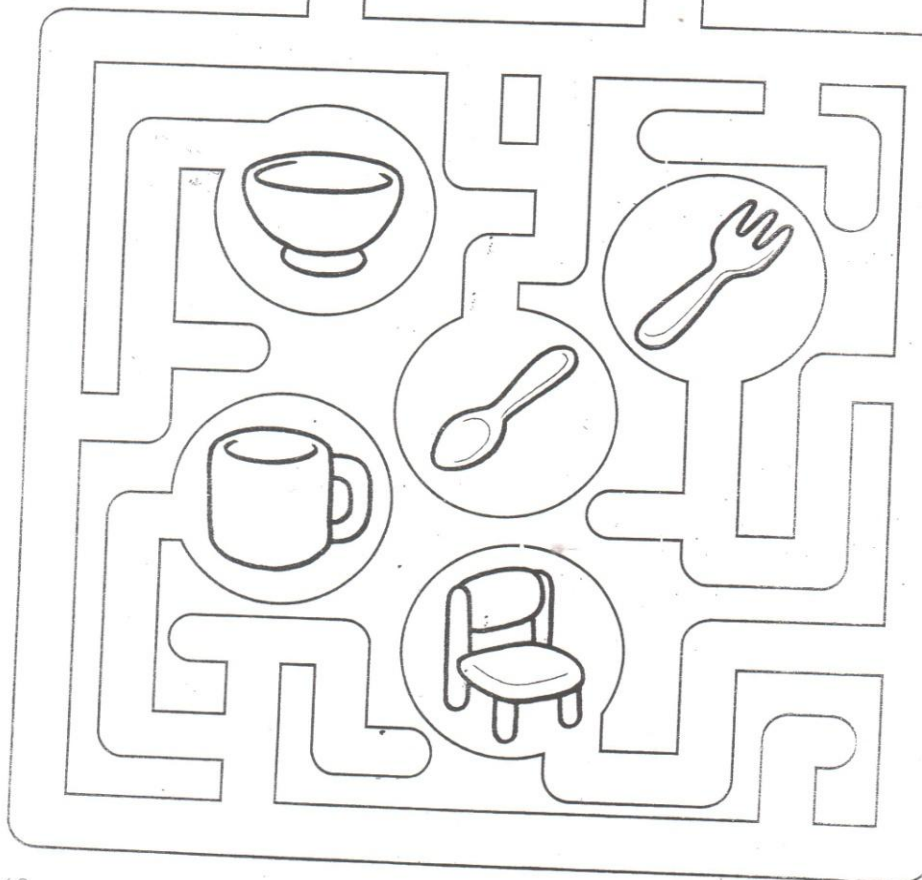
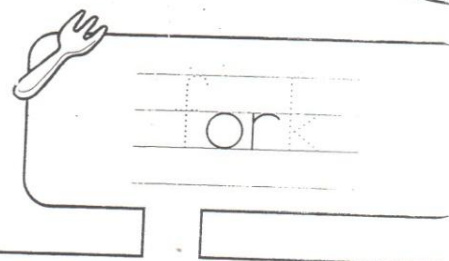
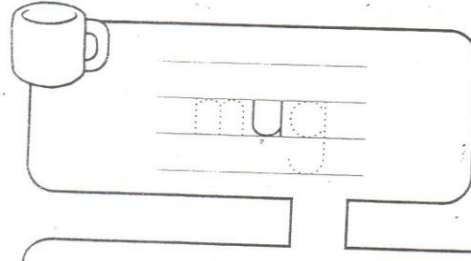

**6** Поставь предложения в вопросительную форму.

1 It is a crocodile.

*Is it a crocodile?*

4 It is a radio.

2 He is Tony.

5 It is a classroom.

3 She is Anna.

6 He is a teacher.

**6** Поставь предложения в вопросительную форму.

1 It is a crocodile.

*Is it a crocodile?*

4 It is a radio.

2 He is Tony.

5 It is a classroom.

3 She is Anna.

6 He is a teacher.

# All About \_\_\_\_\_

I am

\_\_\_\_\_ years old.

This is me...

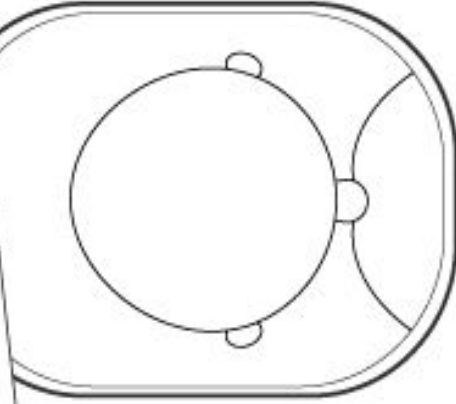

This is my family

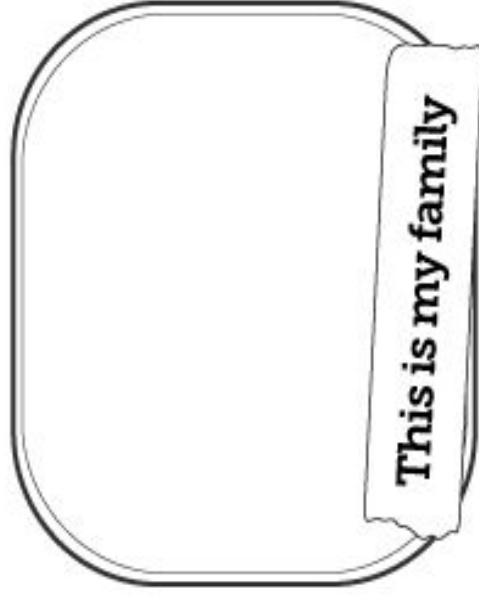

My favorite food is...



My Favorite color is...



I want to be...

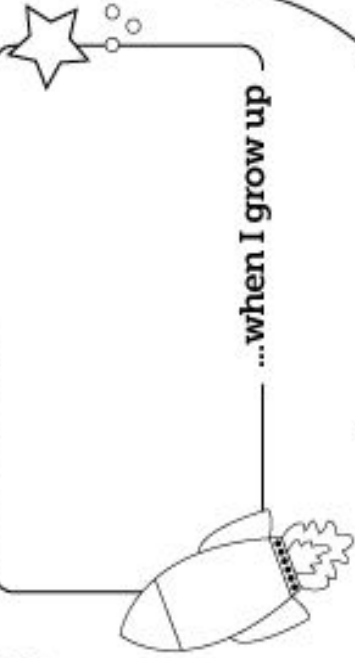

...when I grow up

I love...



# READING SHIP

*By Artem Morozov*

**START**





PLATE





# General questions with TO BE

**AM**



I **am** a student  
of the college.

**IS**



She **is** a  
serious girl.

**ARE**



They **are** at  
college.

**Am** I a student  
of the college?

**Is** she a  
serious girl?

**Are** they at  
college?

---

Yes, I **am**./

Yes, she **is**./

Yes, they **are**./

No, I **am** not.

No, she **is** not.

No, they **are**  
not.