

Элементы цифровой логики

Простейшие логические схемы

Инверторы ($Y = \bar{X}$)

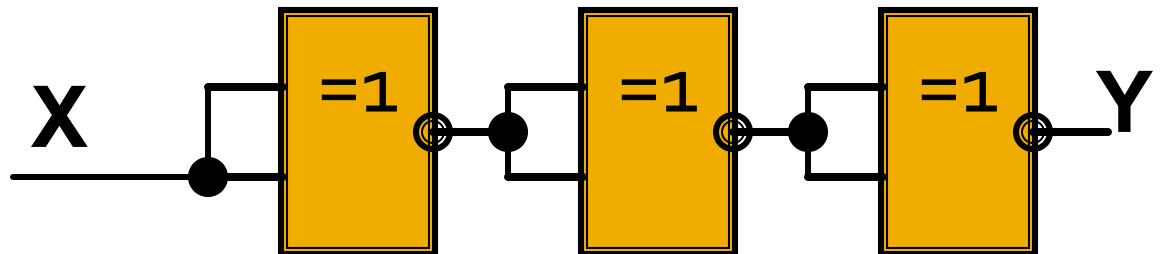
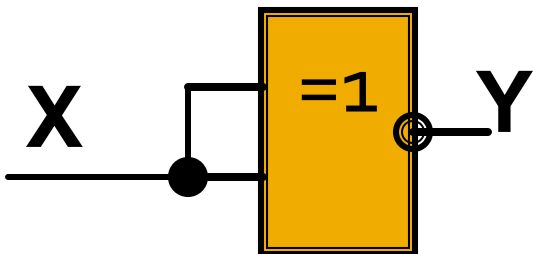
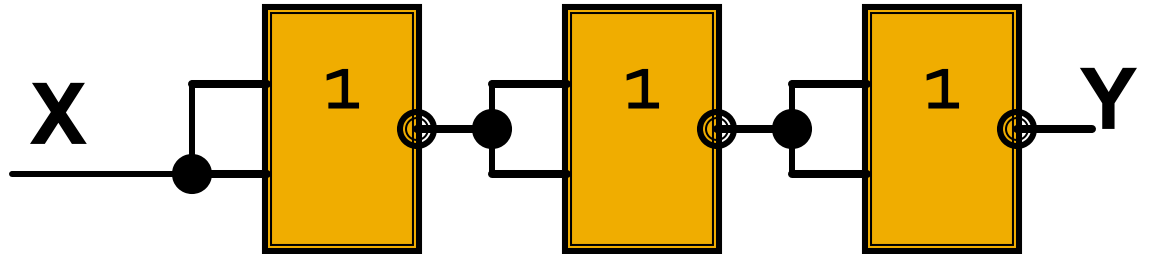
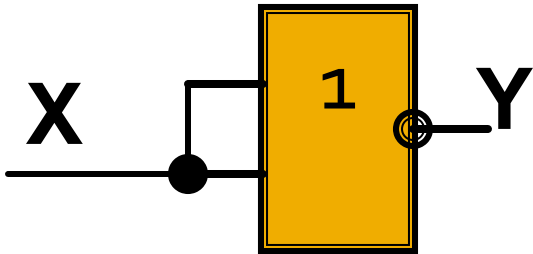
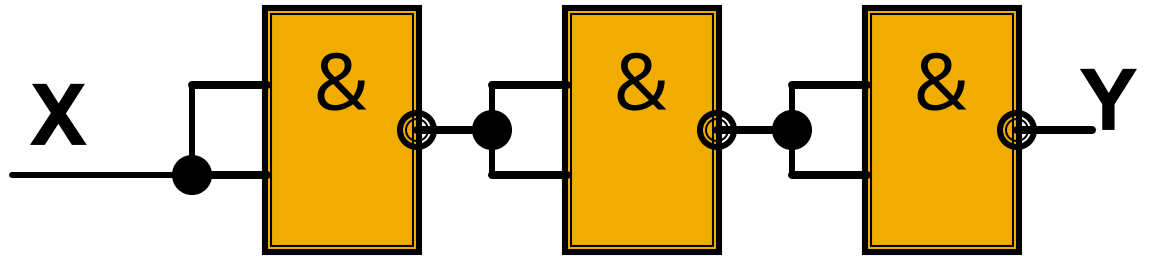
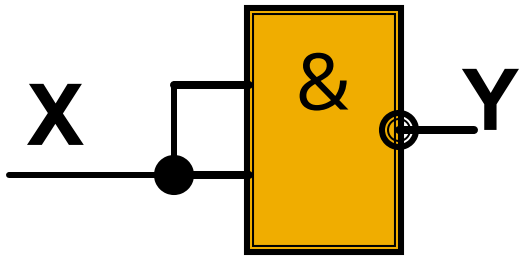
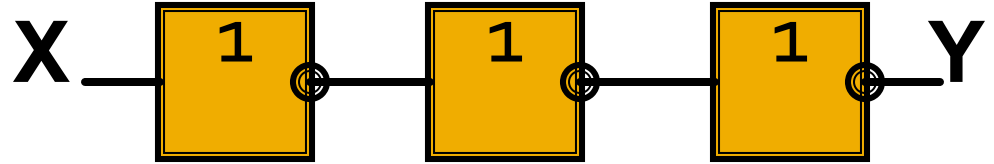
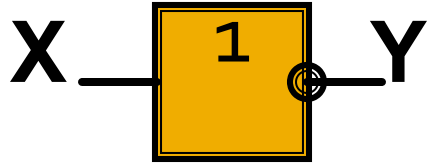

Повторители ($Y=X$)

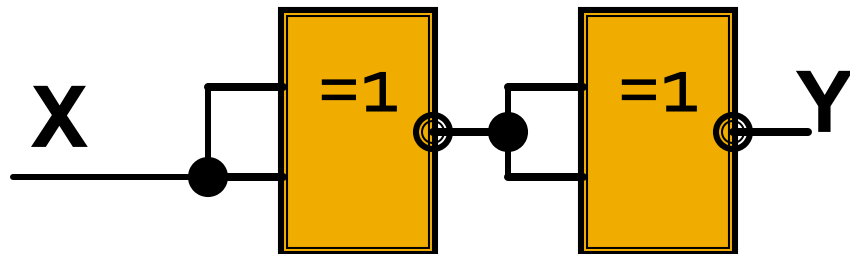
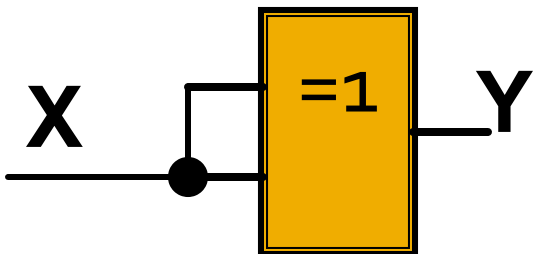
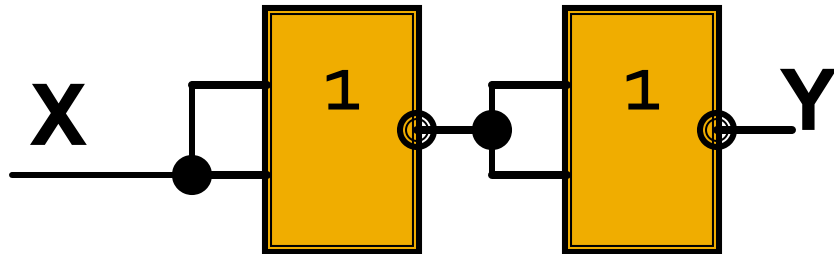
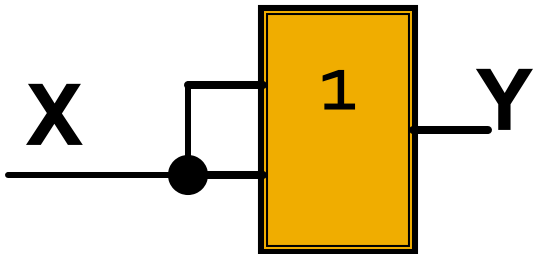
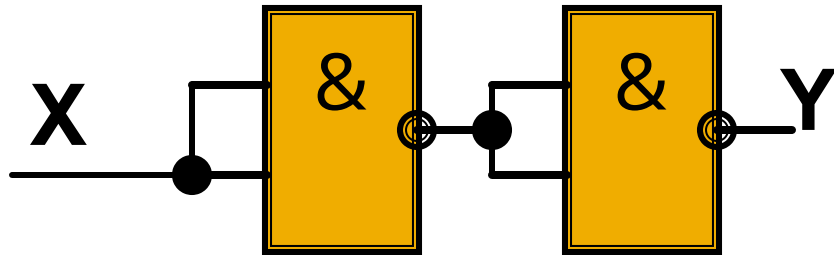
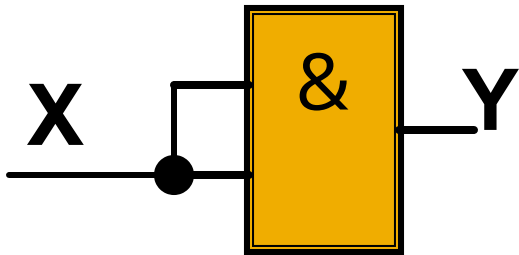
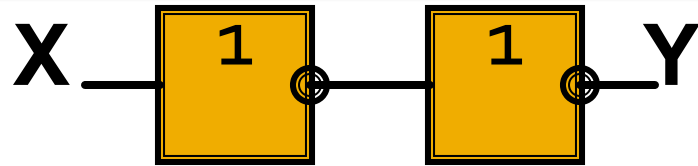
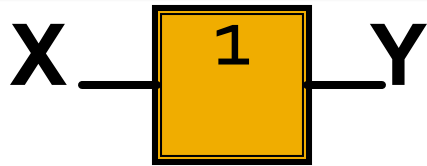

Инверторы ($Y = \bar{X}$)

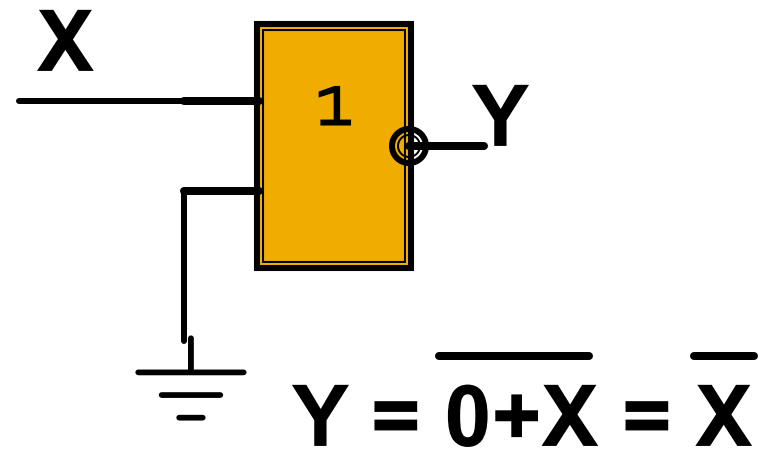
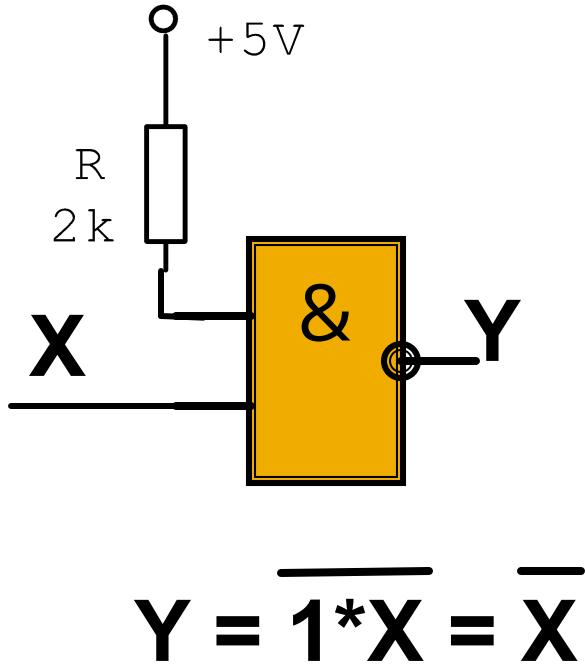

Повторители ($Y=X$)

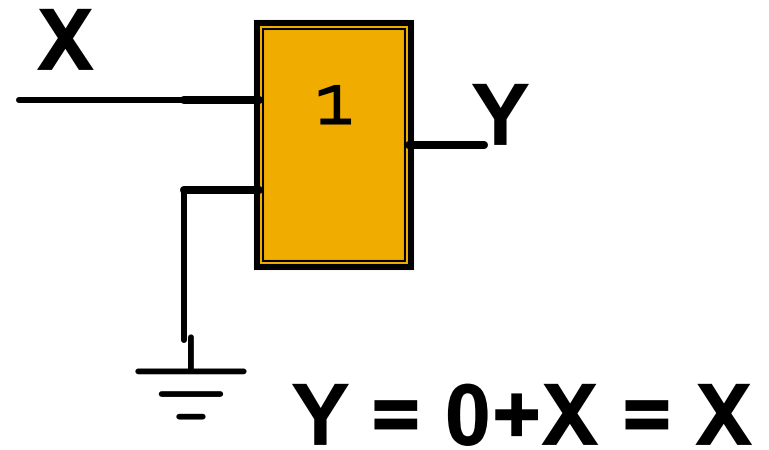
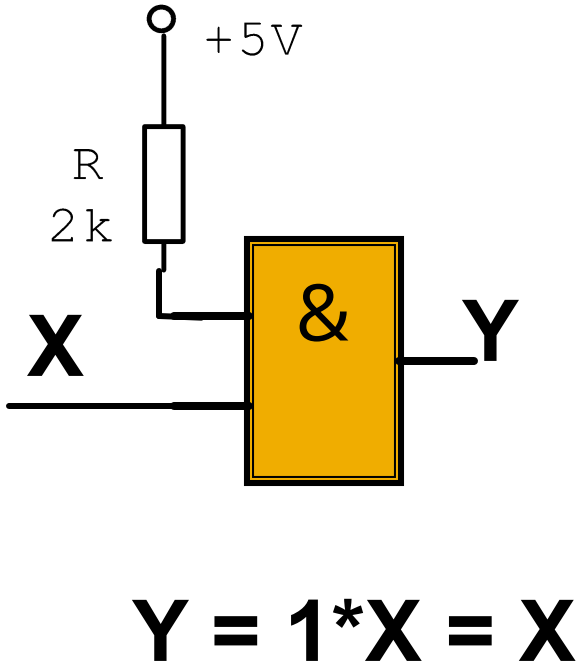

Задание уровня лог "1"

$D_0=D_1=D_2=D_3="1"$

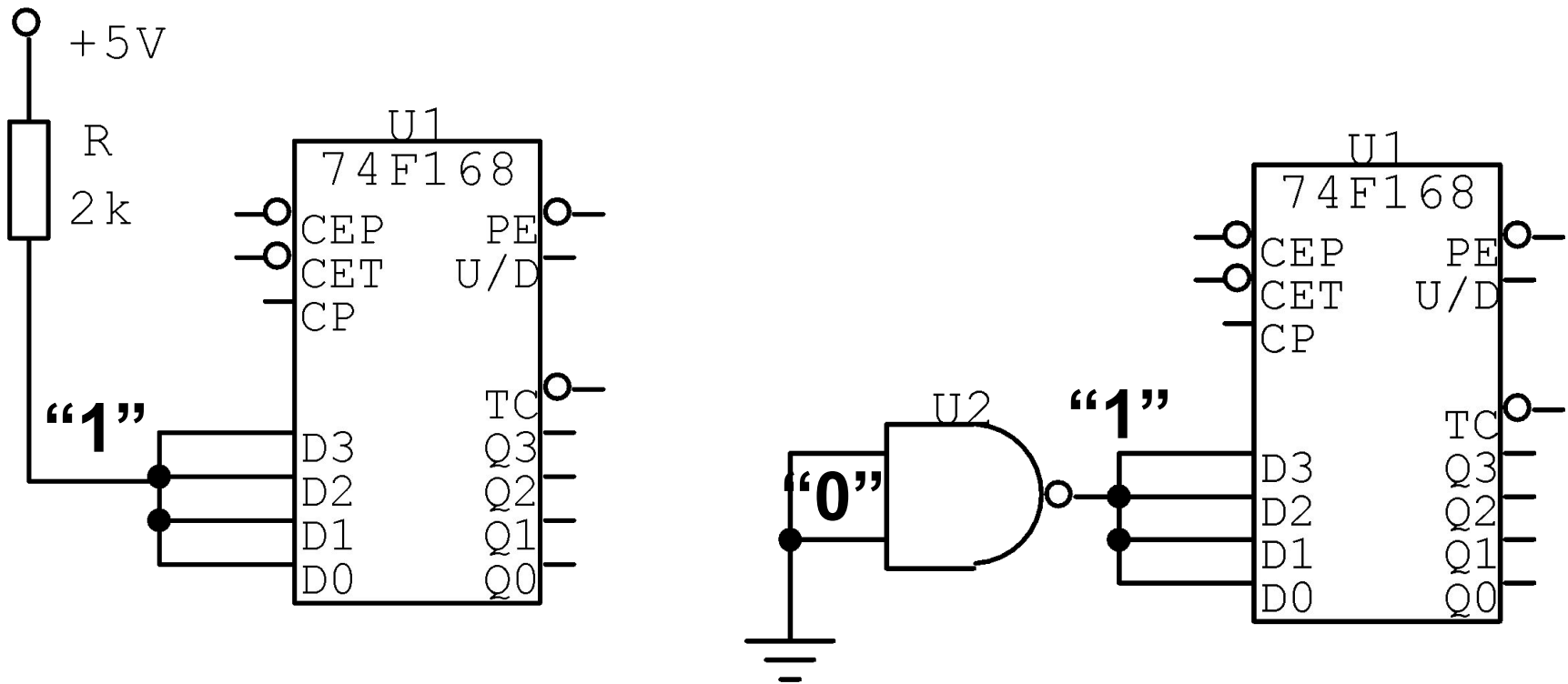

Задание уровня лог "0"

$D_0=D_1=D_2=D_3="0"$

