

Рычаги в технике, быту и природе

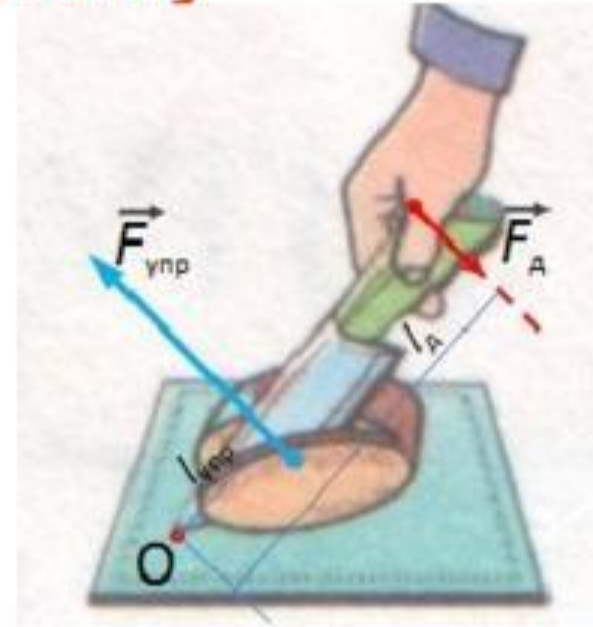

92 249

Рычаги в быту

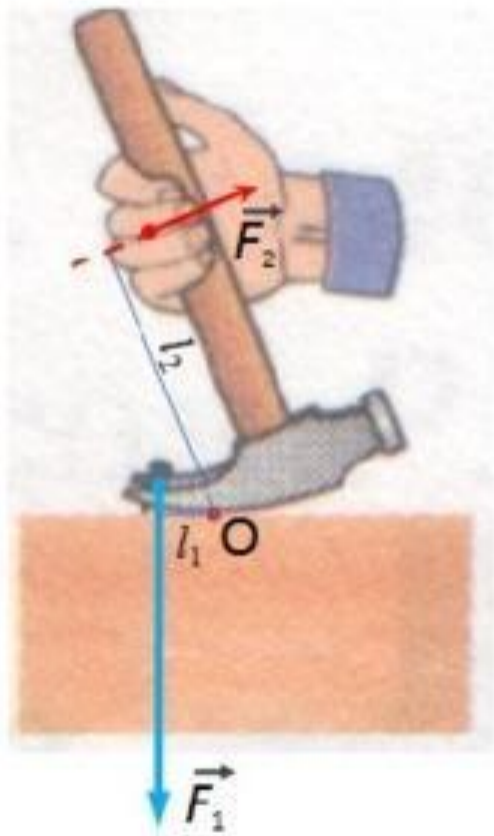







SINGER



SINGER



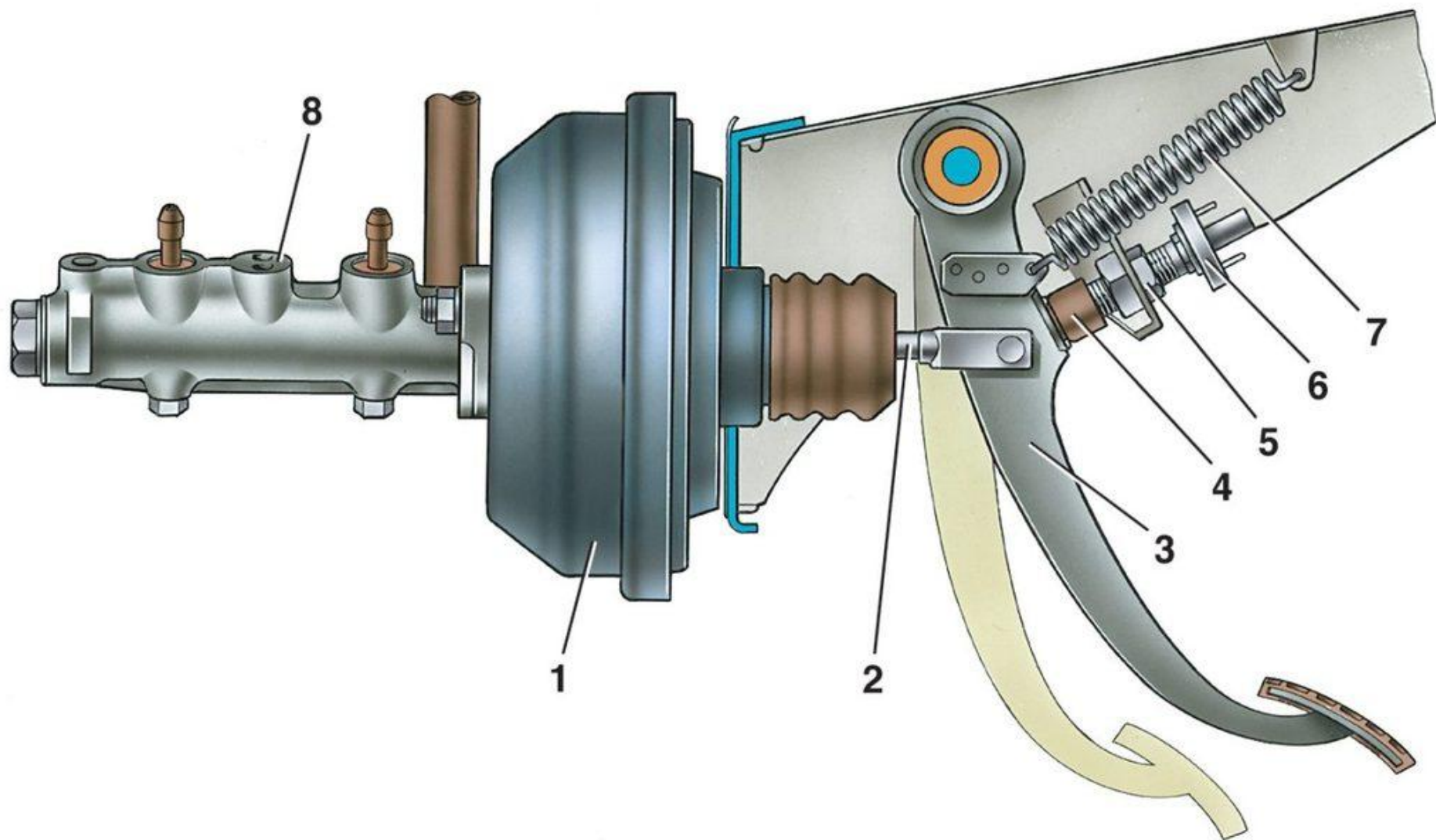









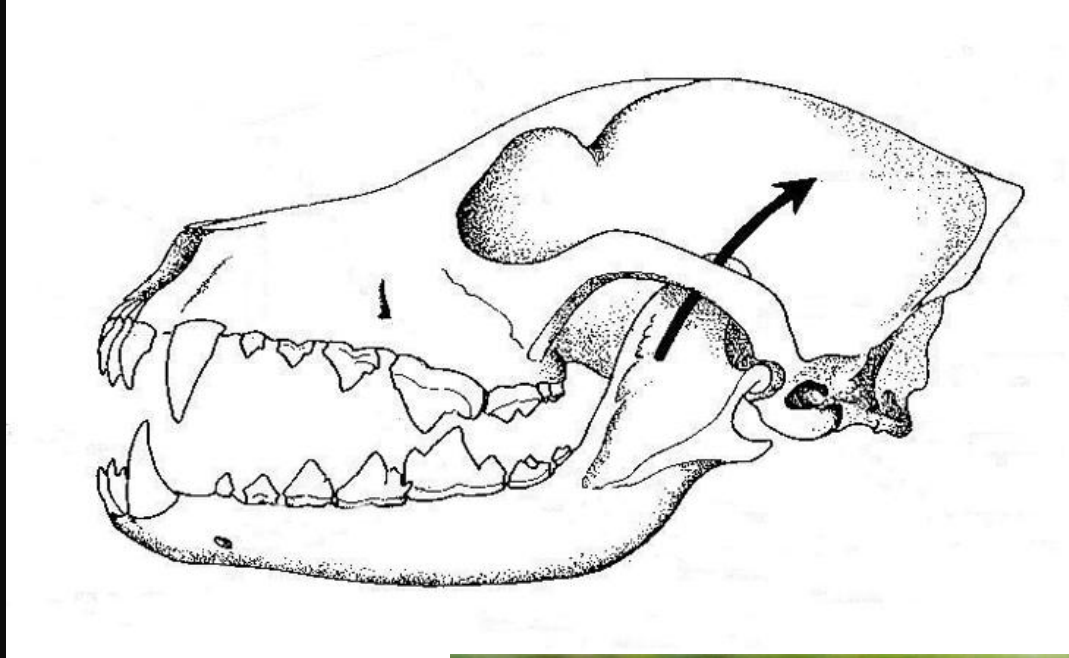

Рука – это «рычаг скорости»

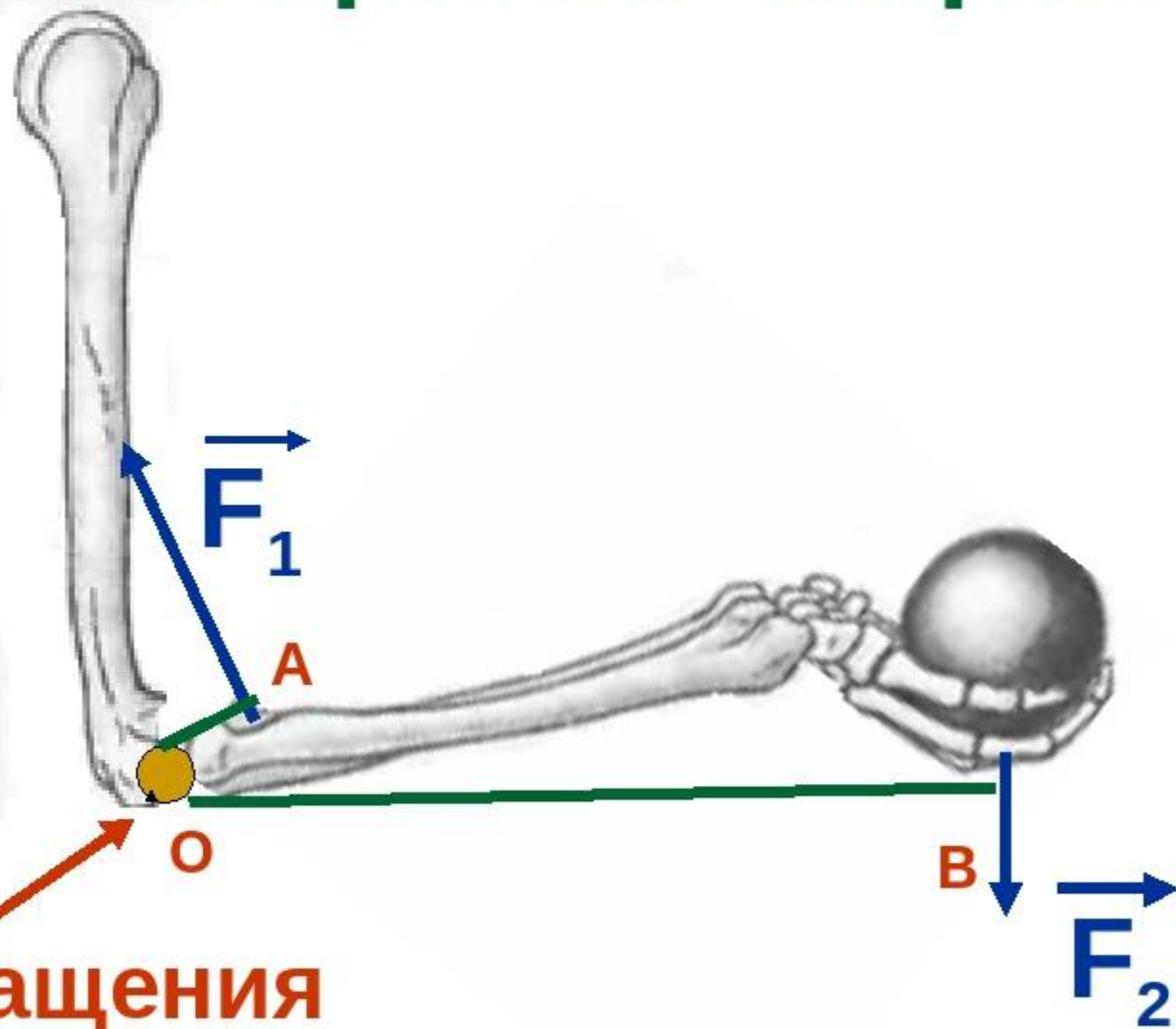

Ось вращения

Начало и место прикрепления мышцы

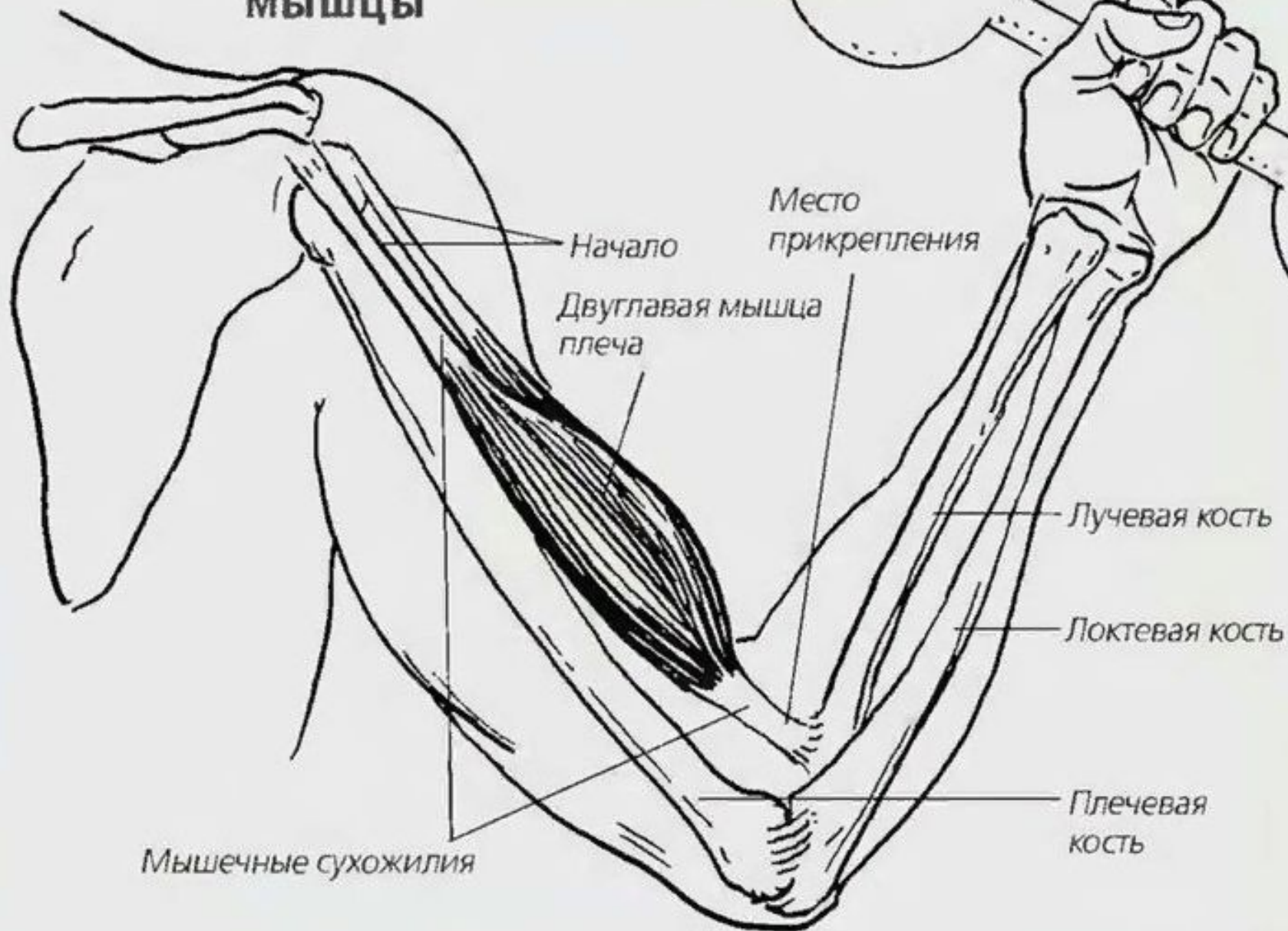

Система

Ка

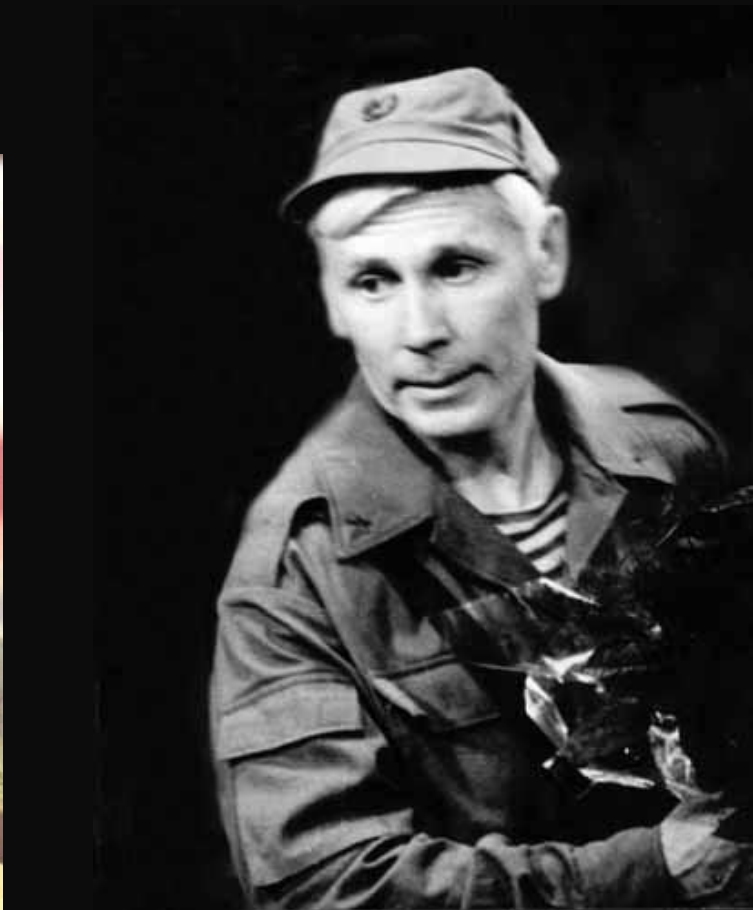

НИКОЛАЙ
ВНУКОВ

СЛУШАЙТЕ
ПЕСНЮ
ПЕРЬЕВ

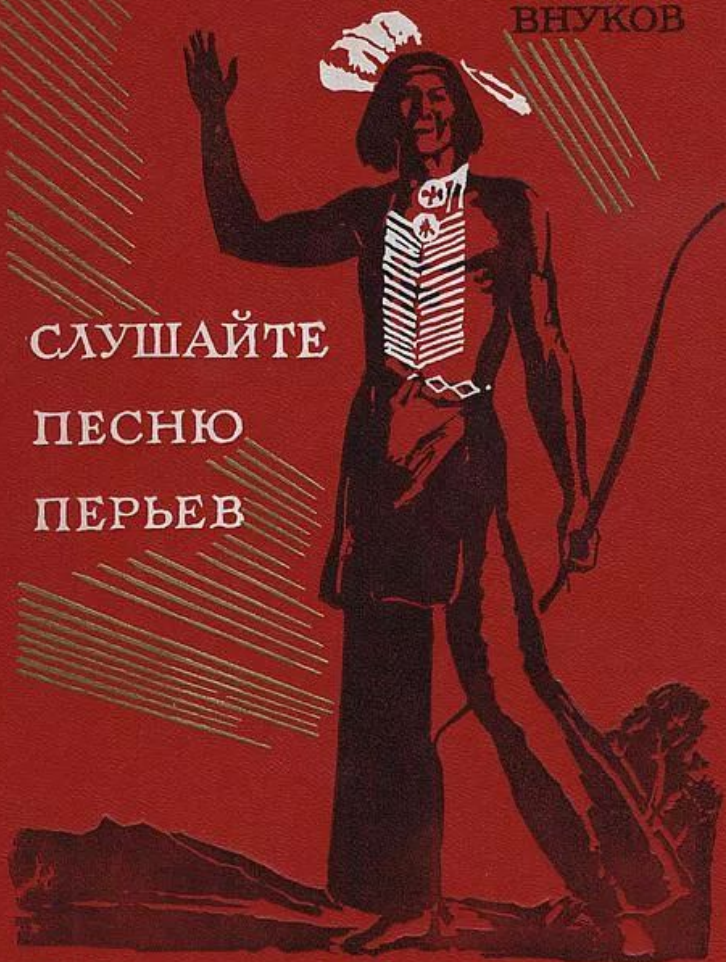

ИЗДАТЕЛЬСТВО «ДЕТСКАЯ ЛИТЕРАТУРА»



Sat-Okb

