



ΦΟΡΜΥΛΑ IQ

The title is rendered in a playful, stylized font. The Greek letters 'Φ' and 'Ω' are integrated into a blue gear. The 'Ρ' is a yellow cylinder. The 'Μ' has a small yellow figure with a starburst above it. The 'Υ' is a yellow cylinder. The 'Λ' is a yellow cylinder. The 'Α' is a yellow cylinder. The 'Ι' is a yellow cylinder. The 'Q' is a yellow cylinder with a blue outline. The background is white with a yellow border that has a mechanical, industrial feel with various panels and buttons.

Κυρς 5+



**Давайте знакомиться!**



# Такие удивительные пауки



**Не боимся пауков!**

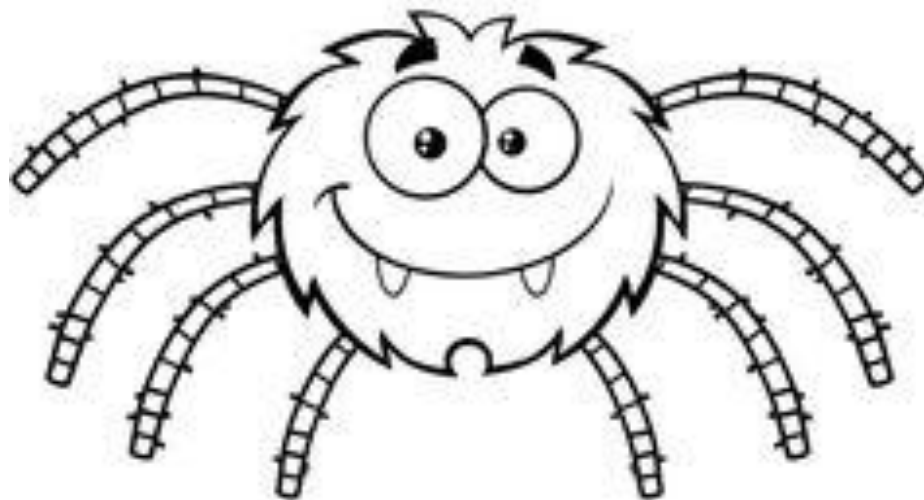

# Поможем пауку выйти из лабиринта



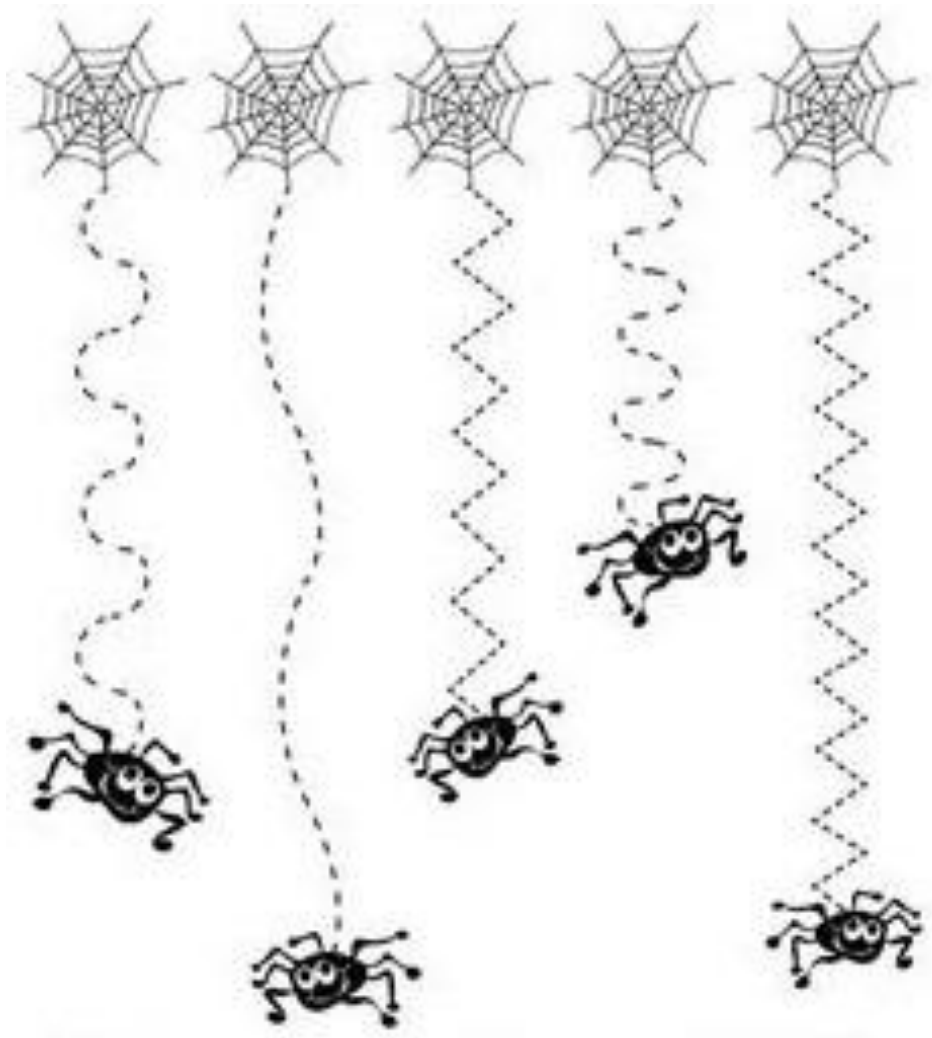

# Подуем на паучка



# Физминутка





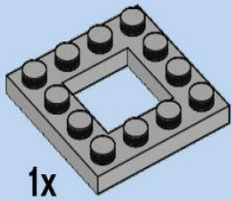

1x

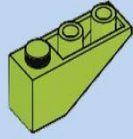

2x

1

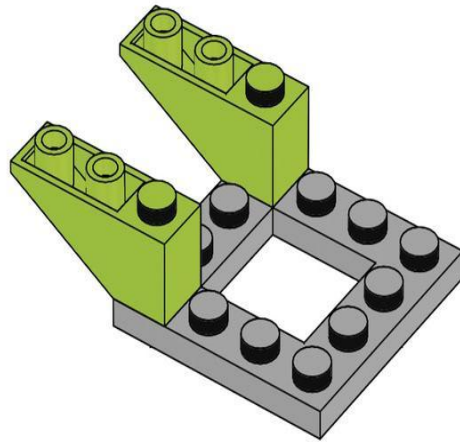

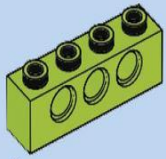

2x

2

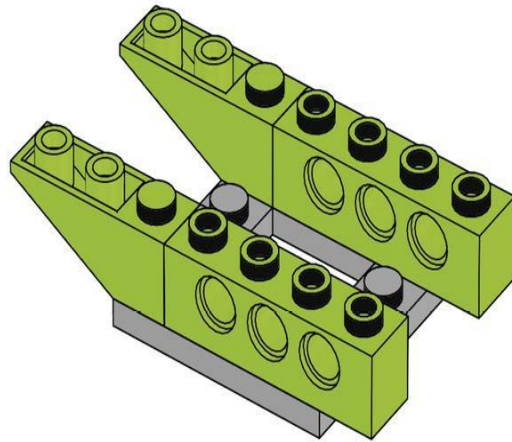

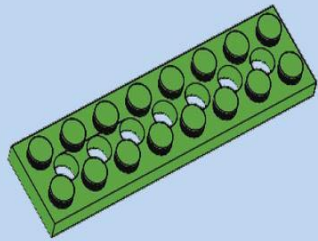

2x

3

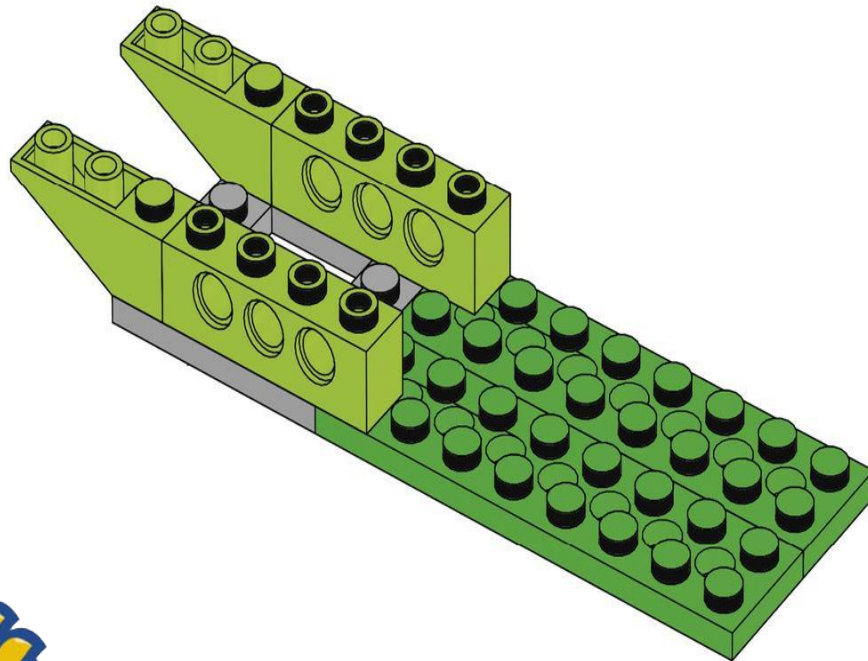



2x

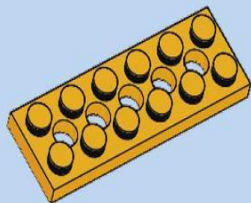

1x

4

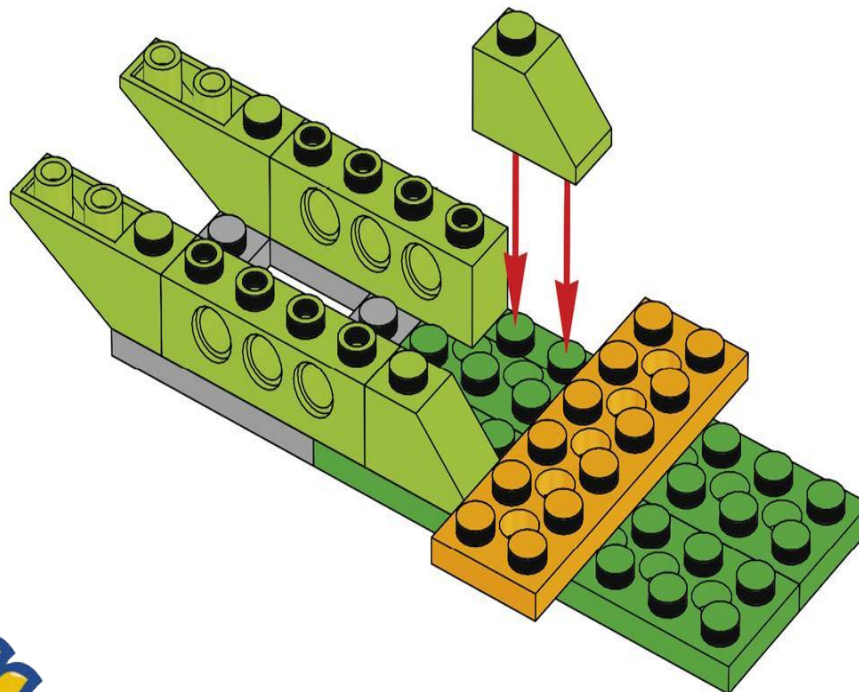



2x

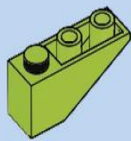

2x

5

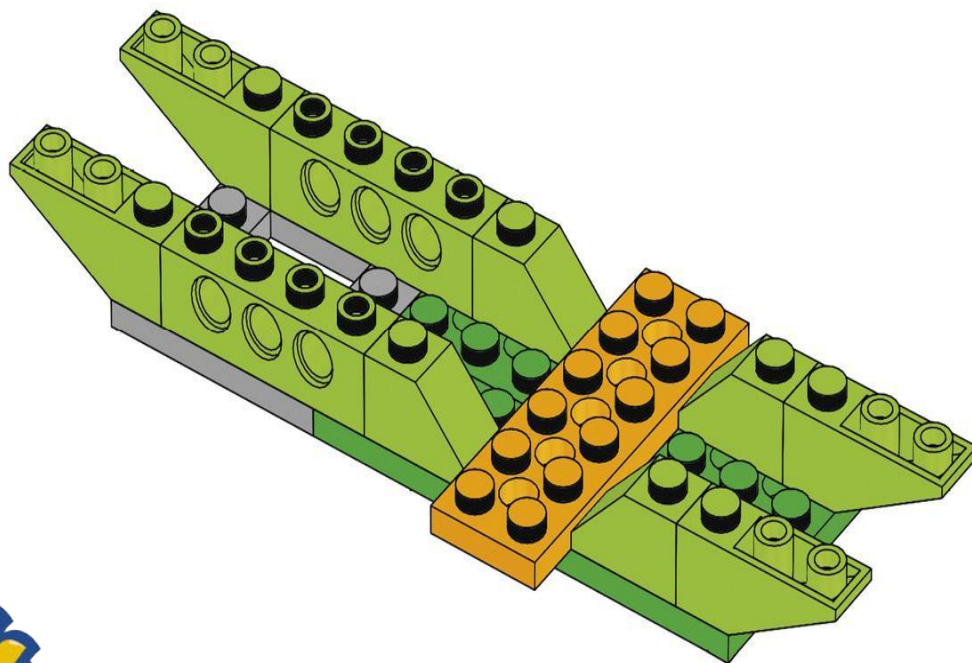

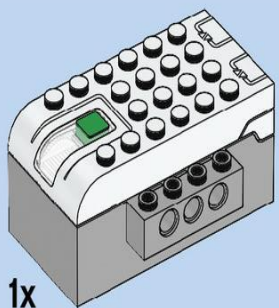

1x

6

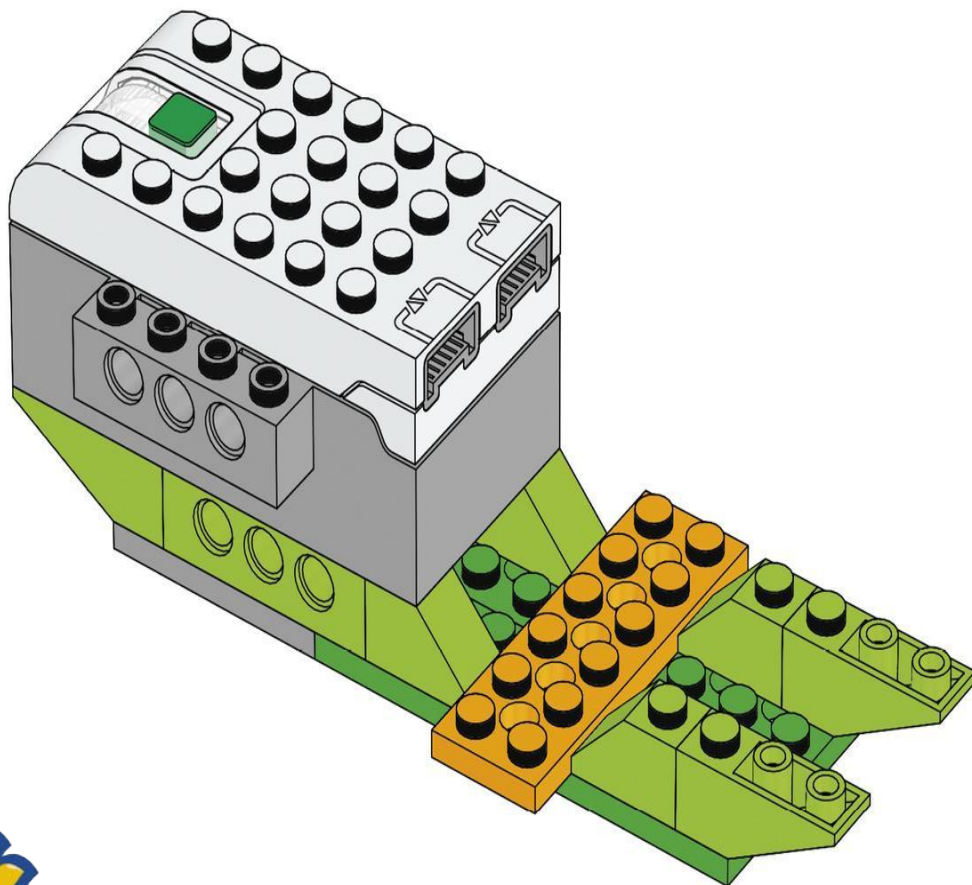

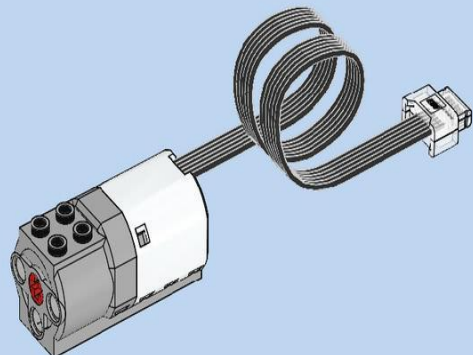

1x

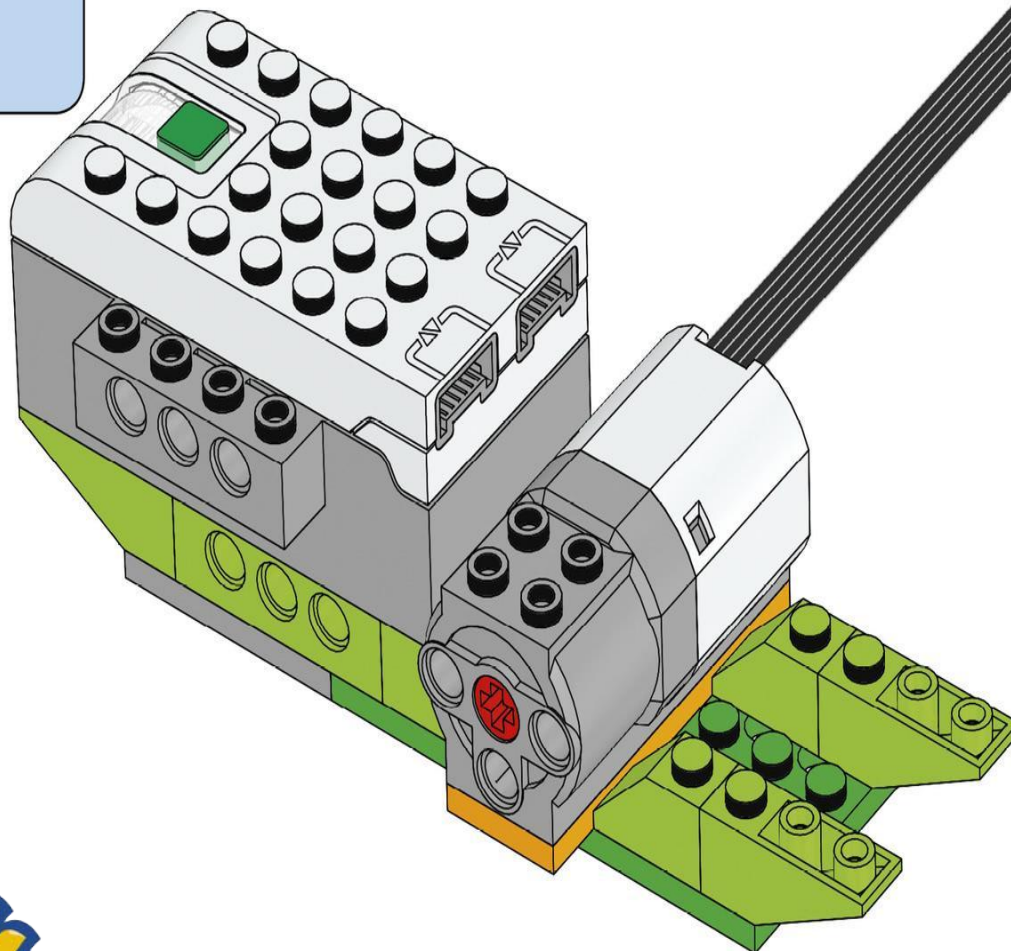



1x



1x

8

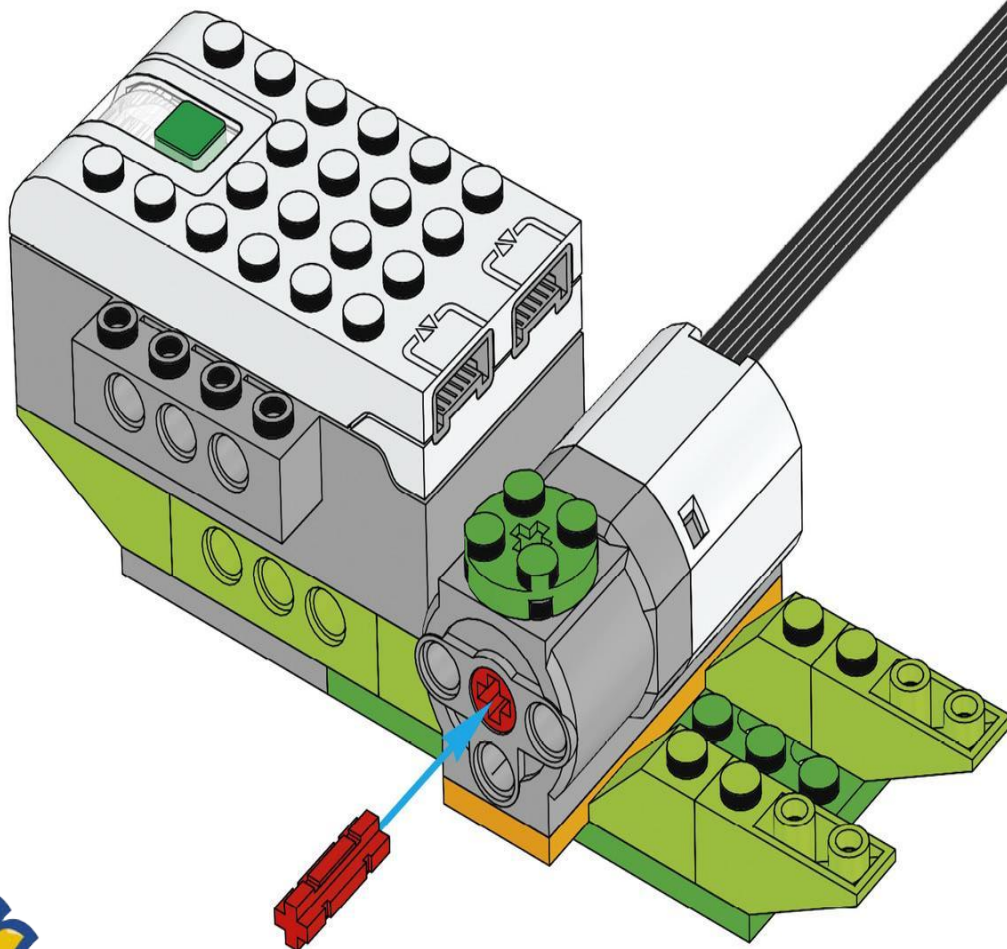





2x

9

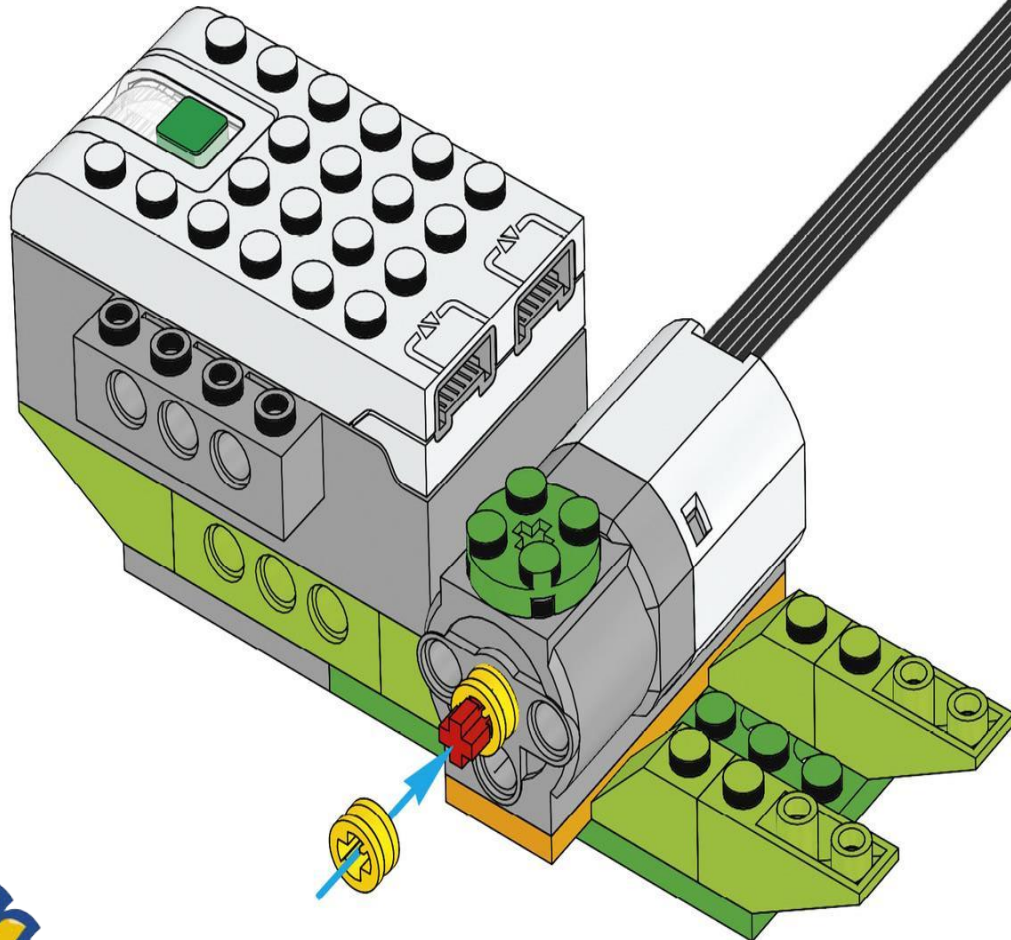

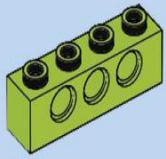

2x

10

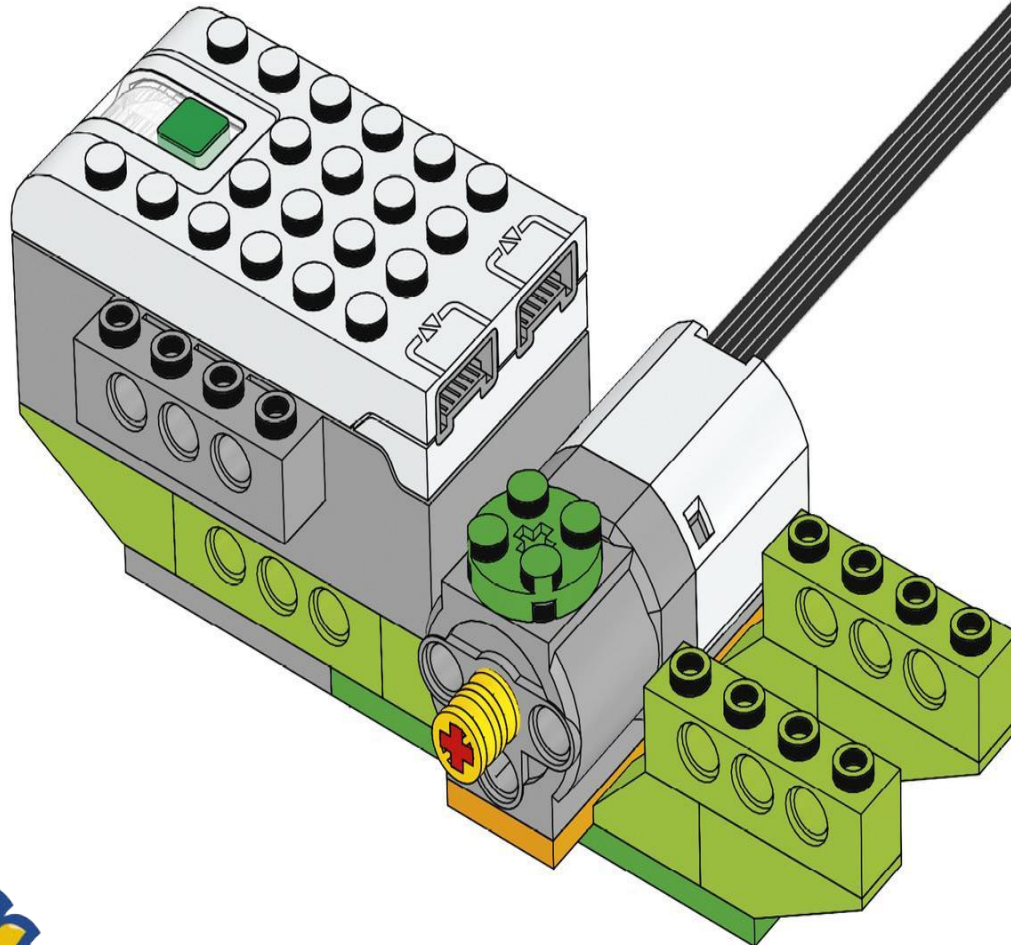

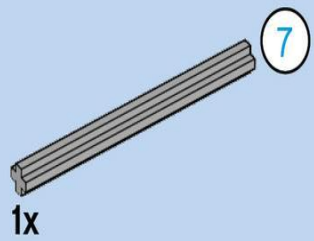

11

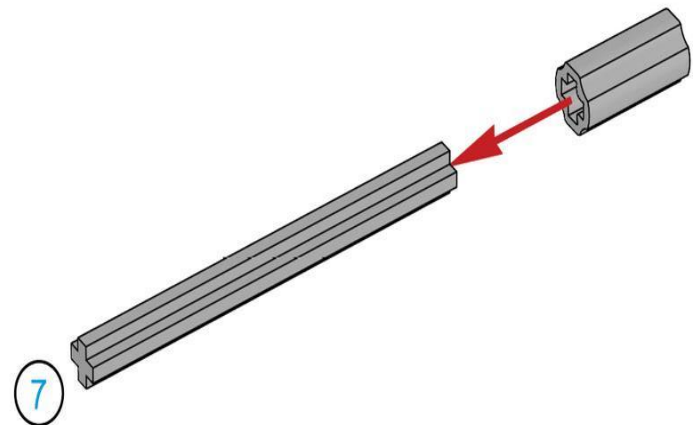



1x

12

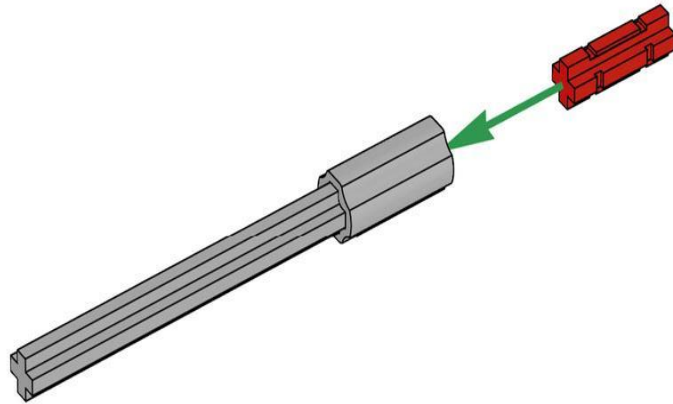



1x

13

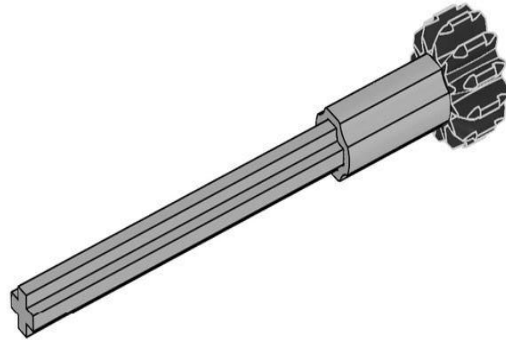

14

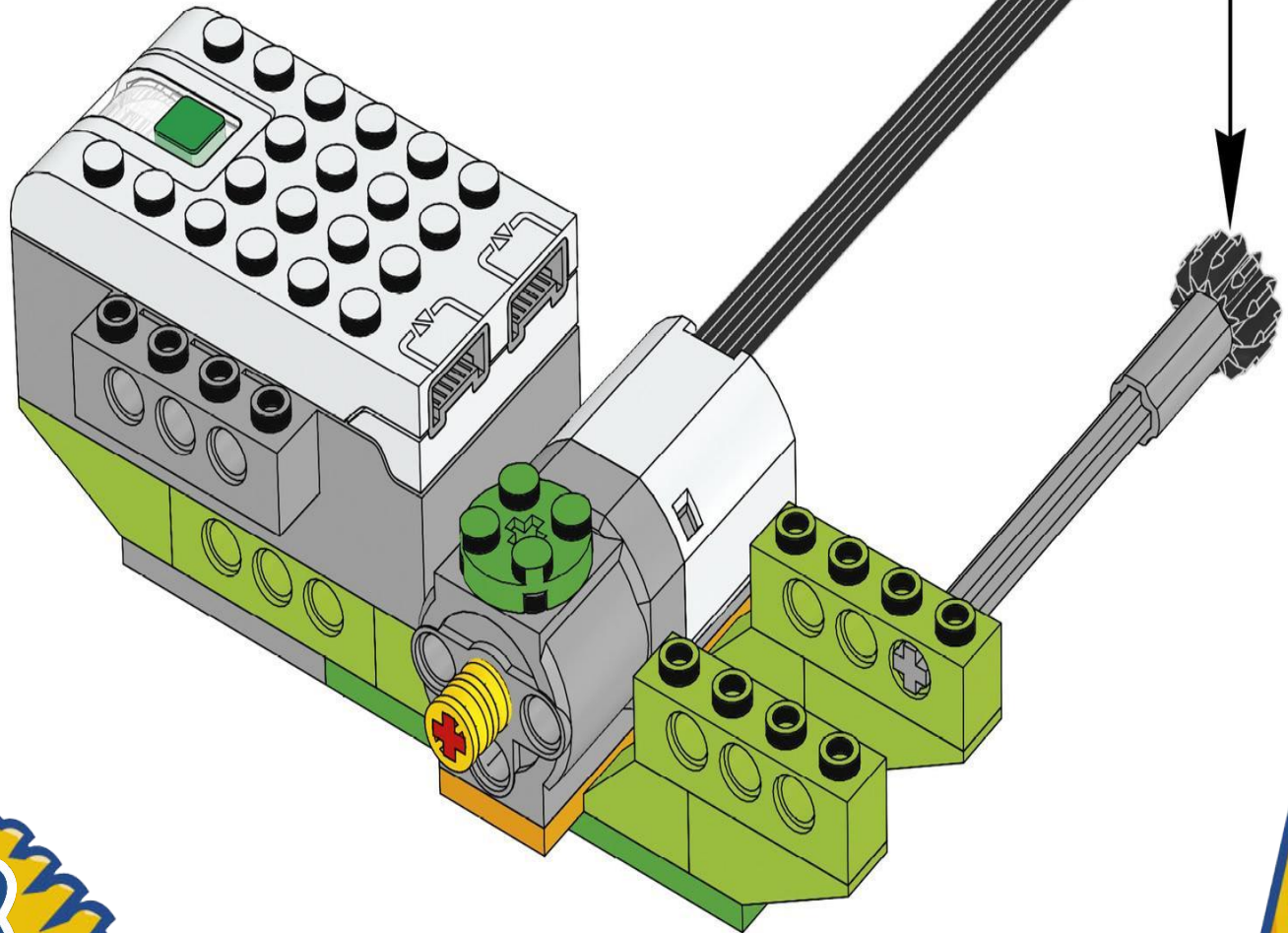



1x



1x

15

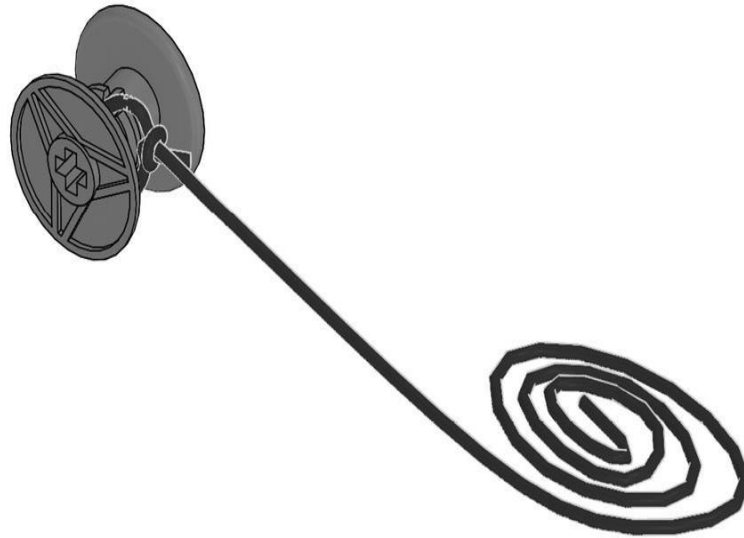



1x

# 16

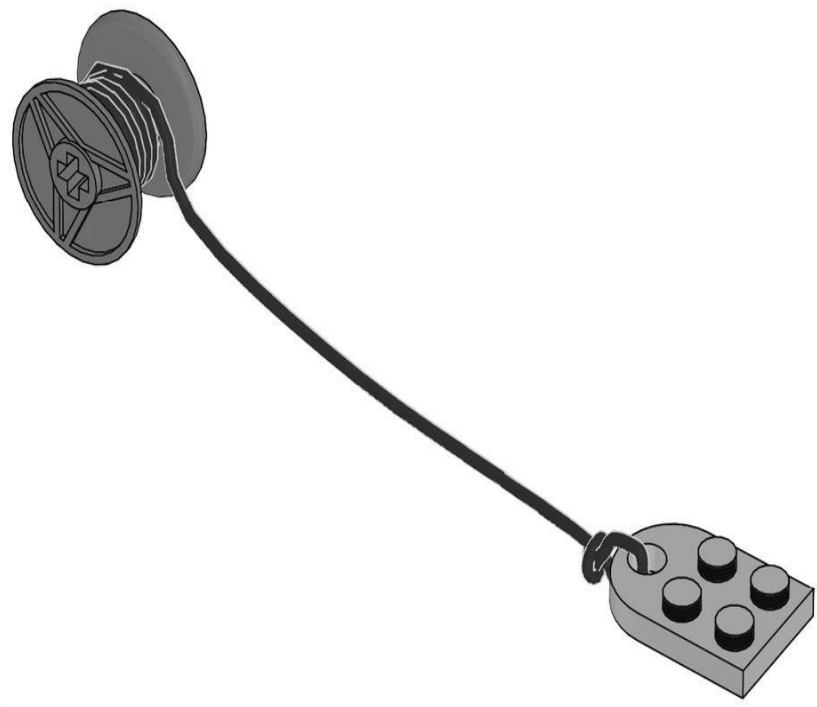



17

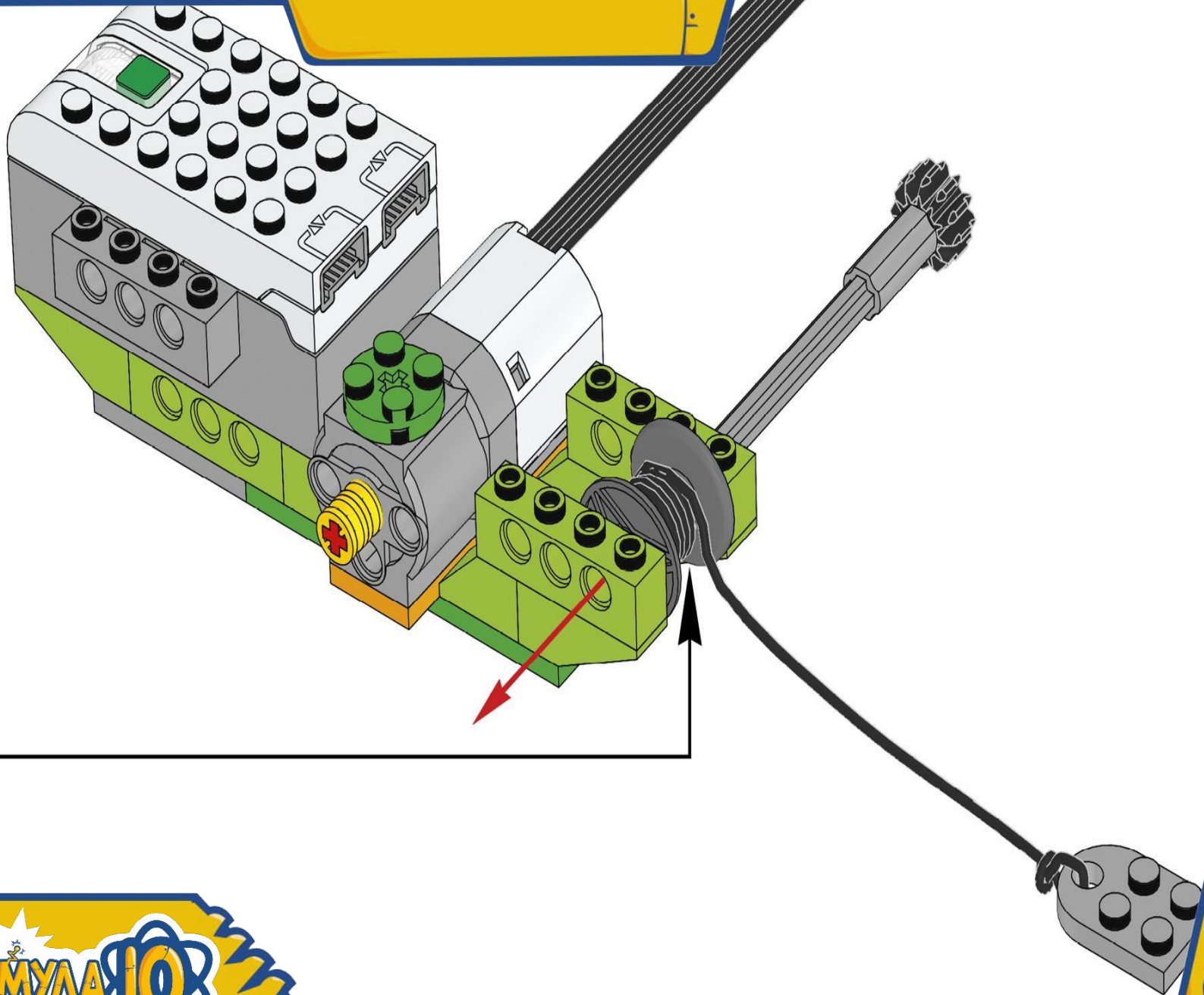



1x

18

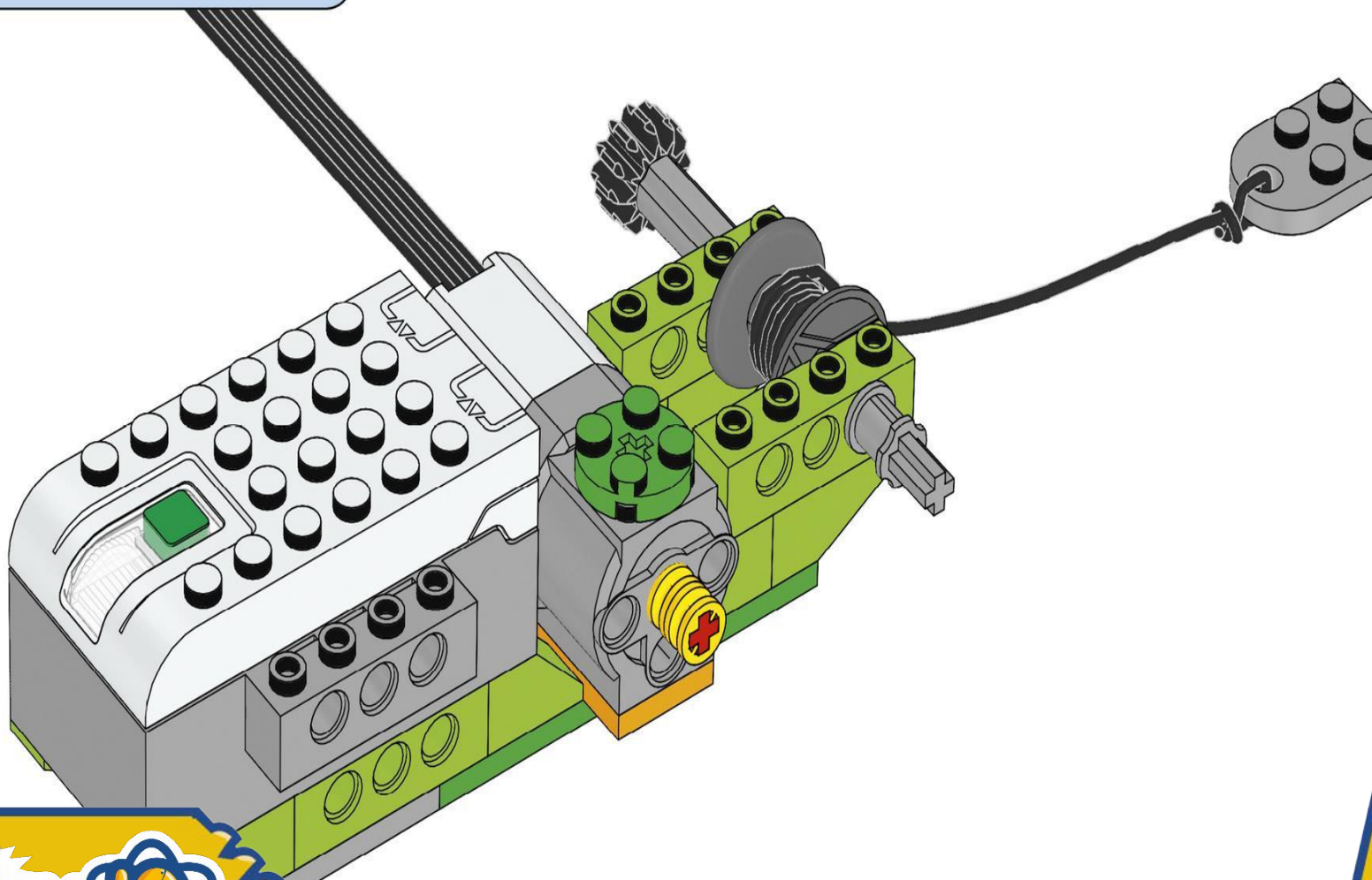





4x

20

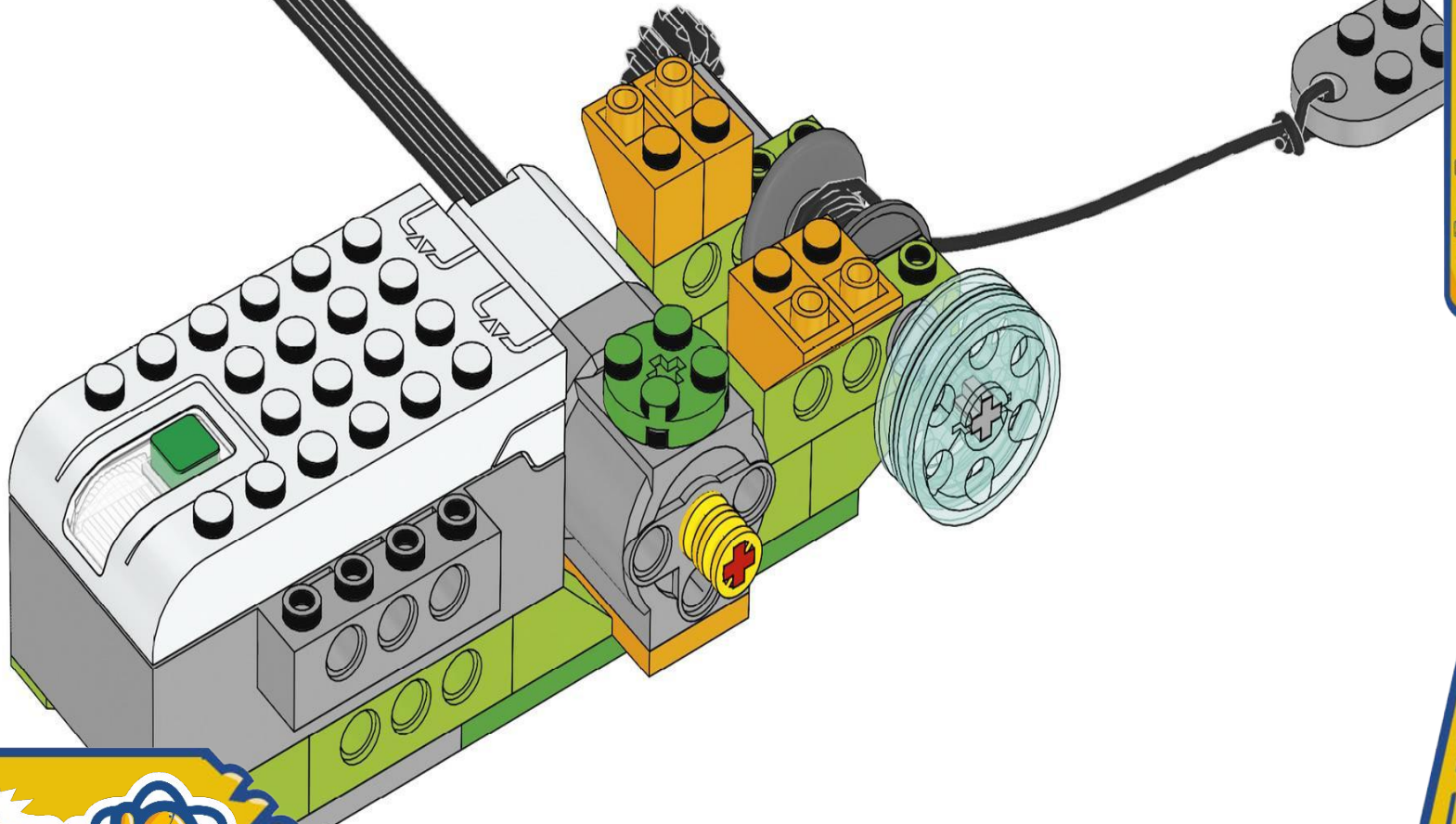

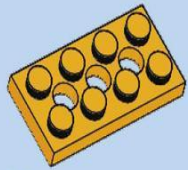

1x

21

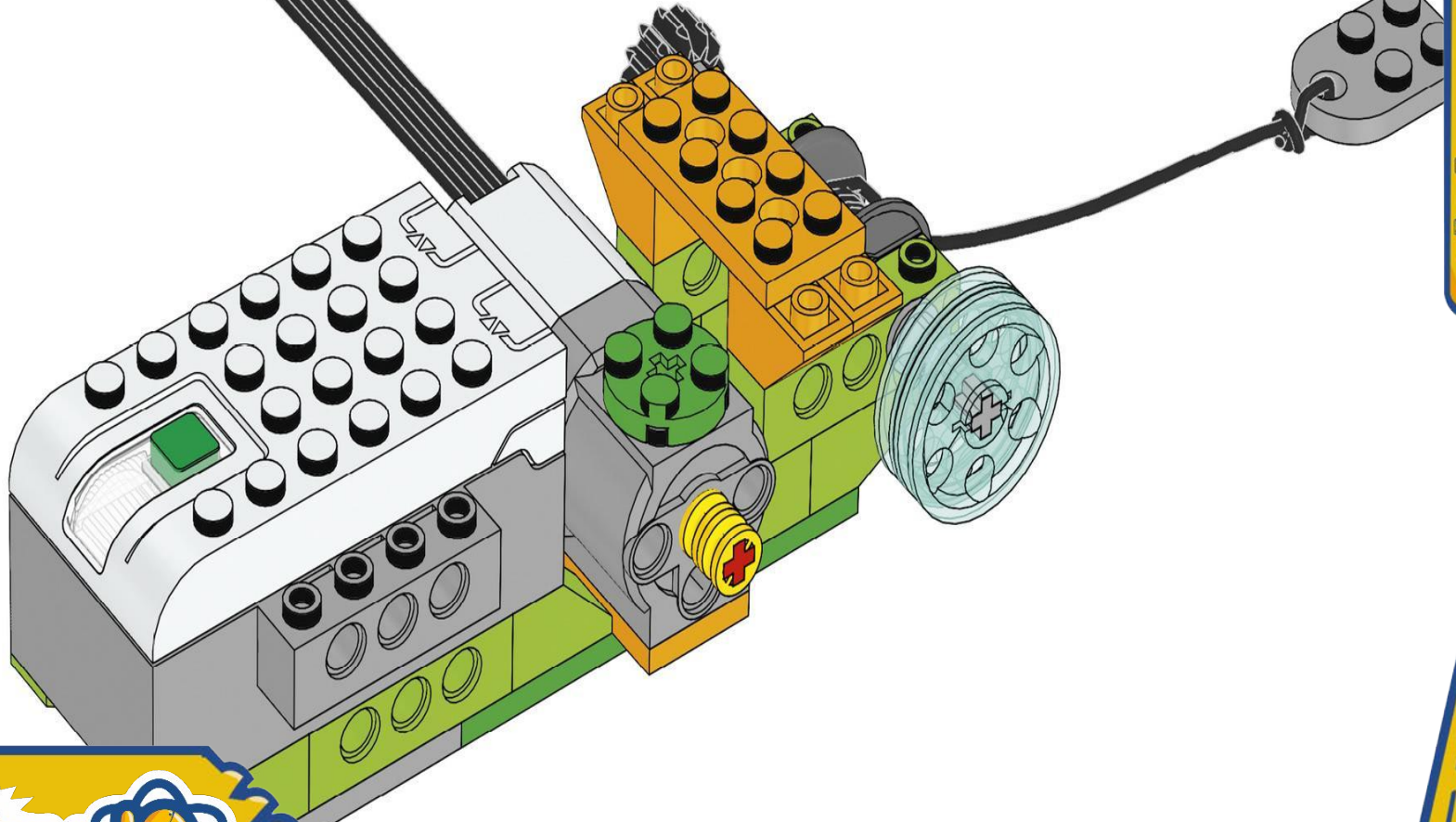

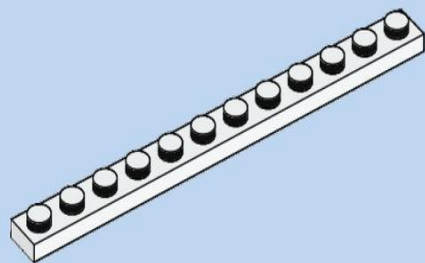

2x

22

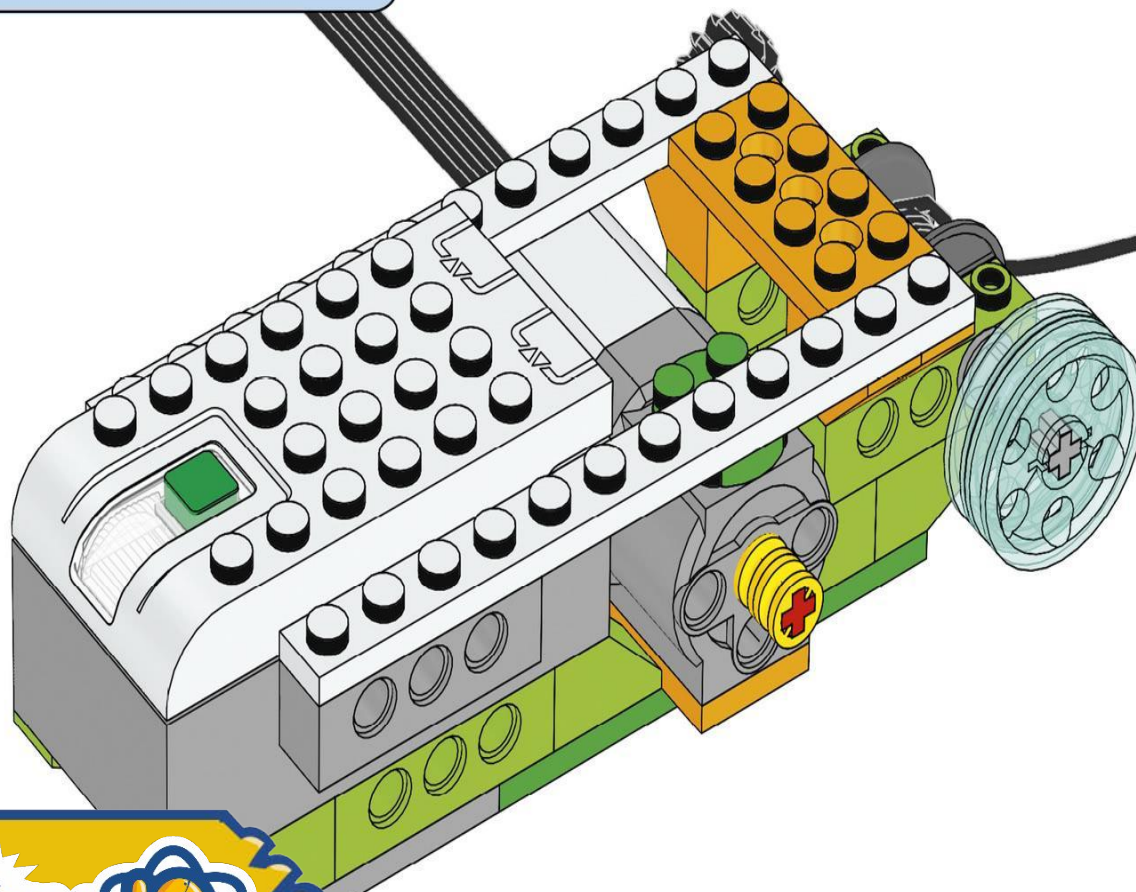

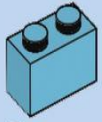

2x

23

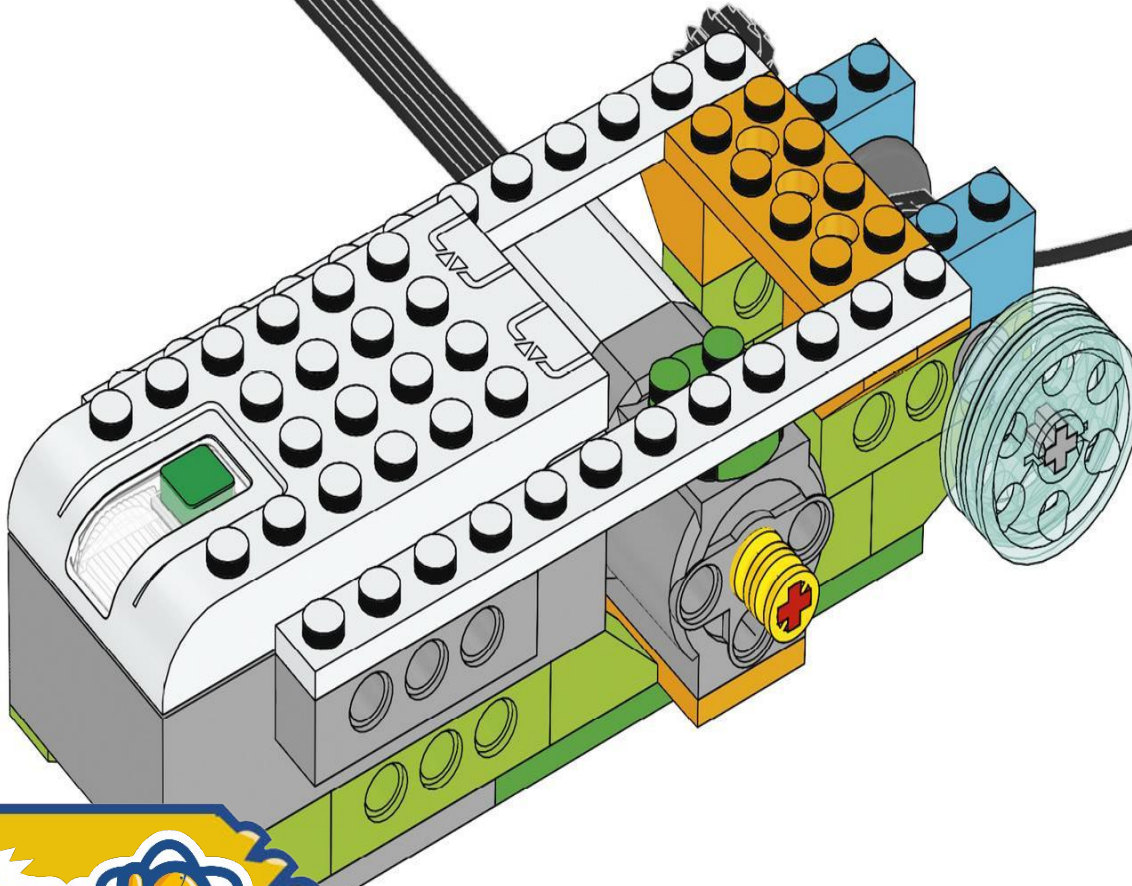



1x

24

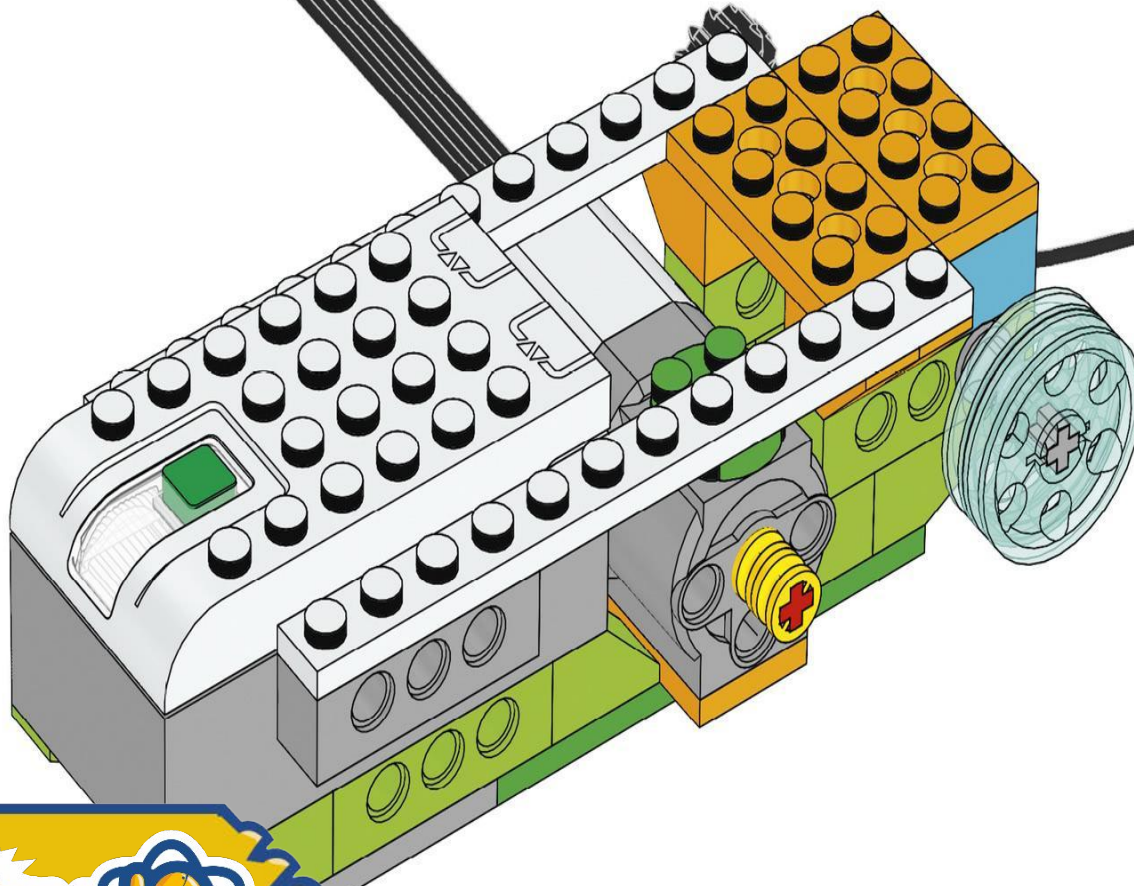



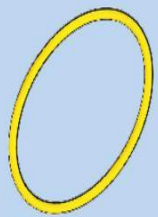

2x

25

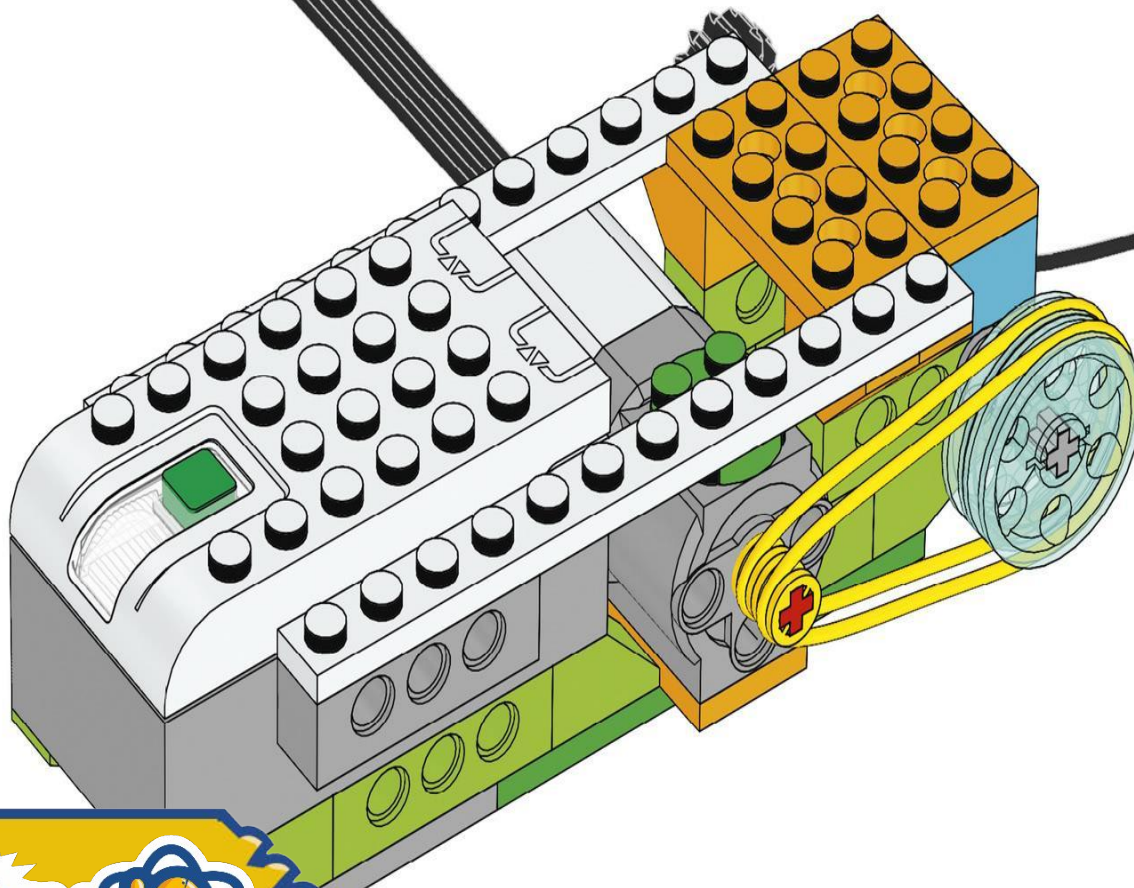

26

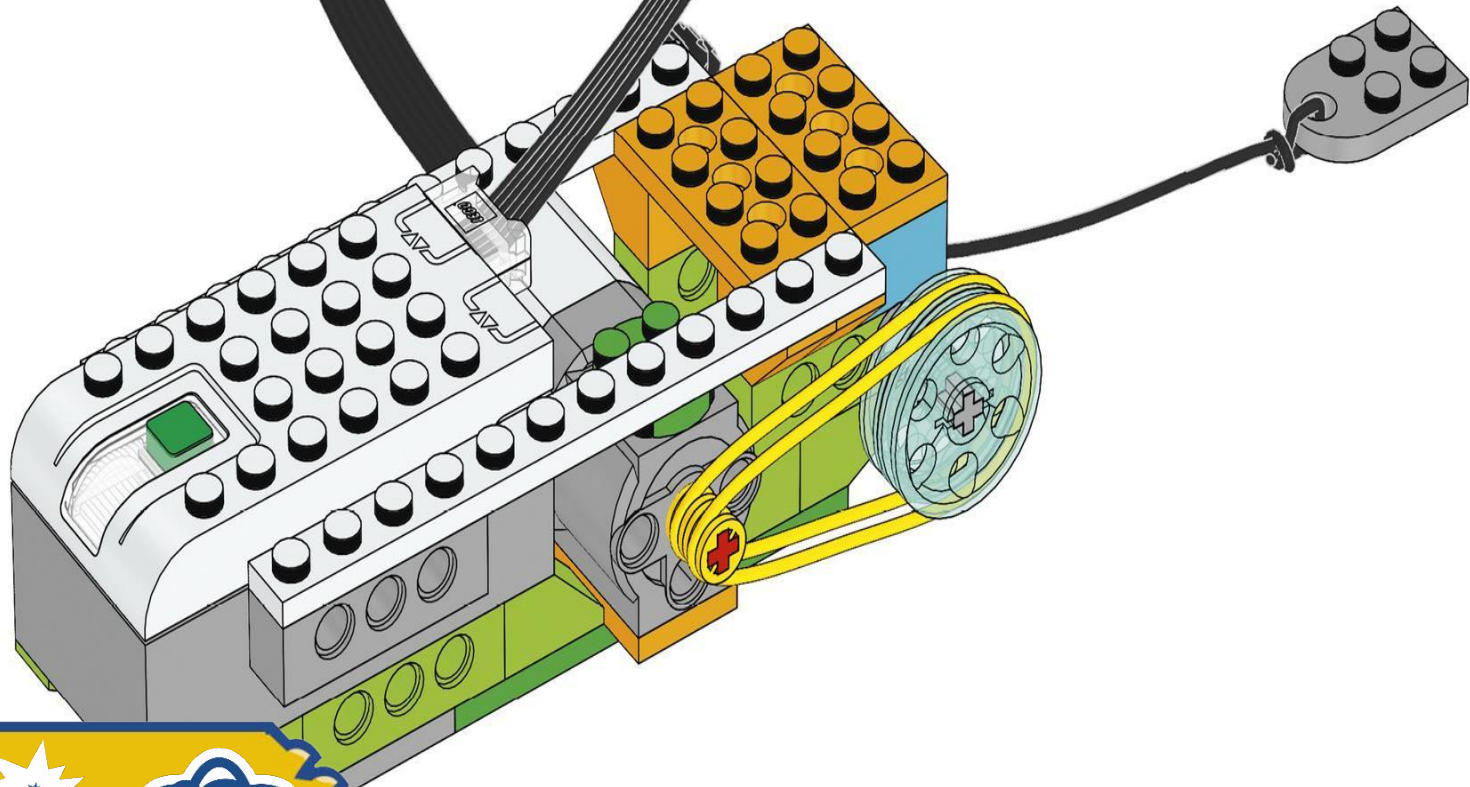

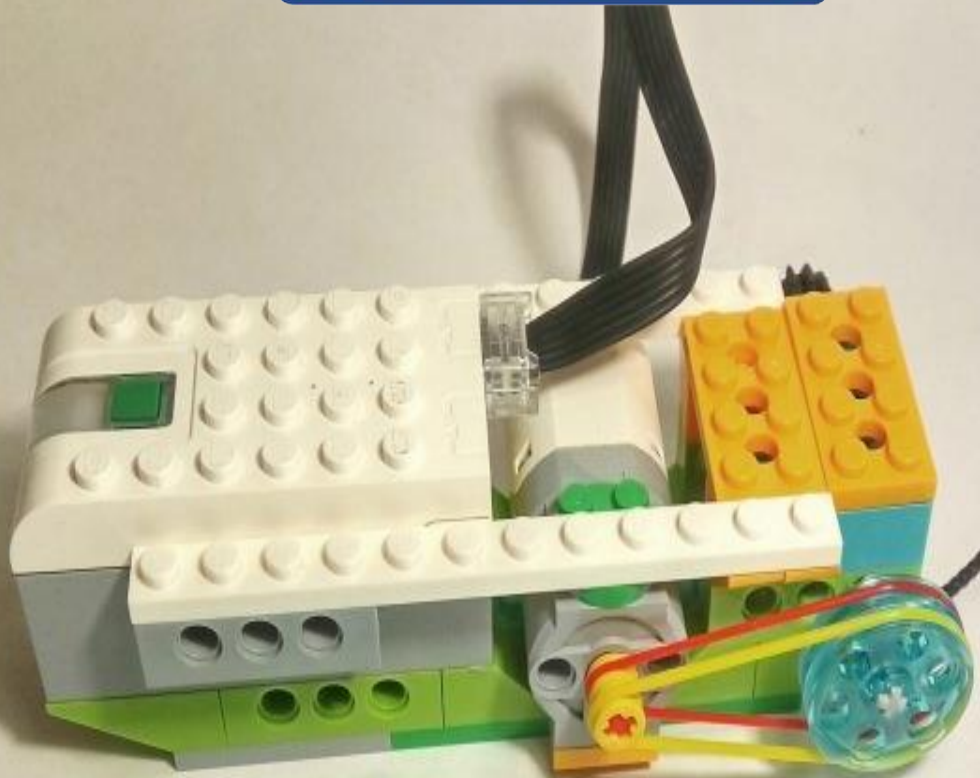

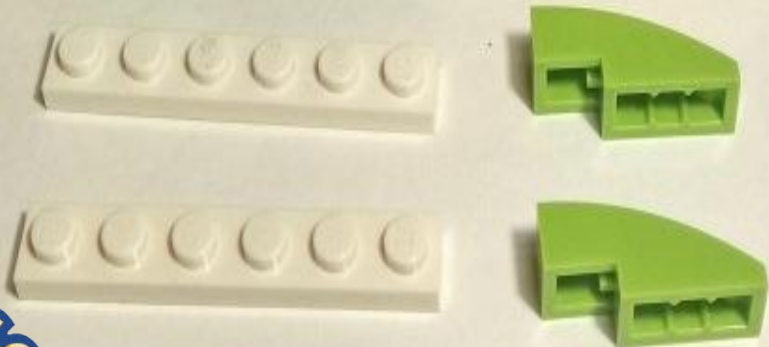
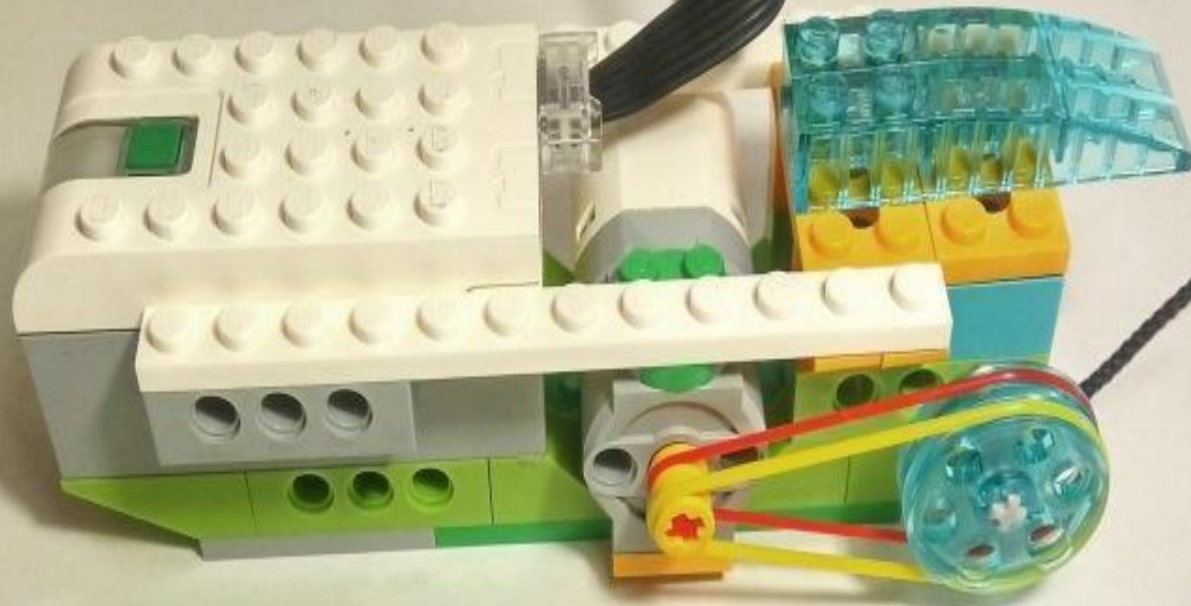

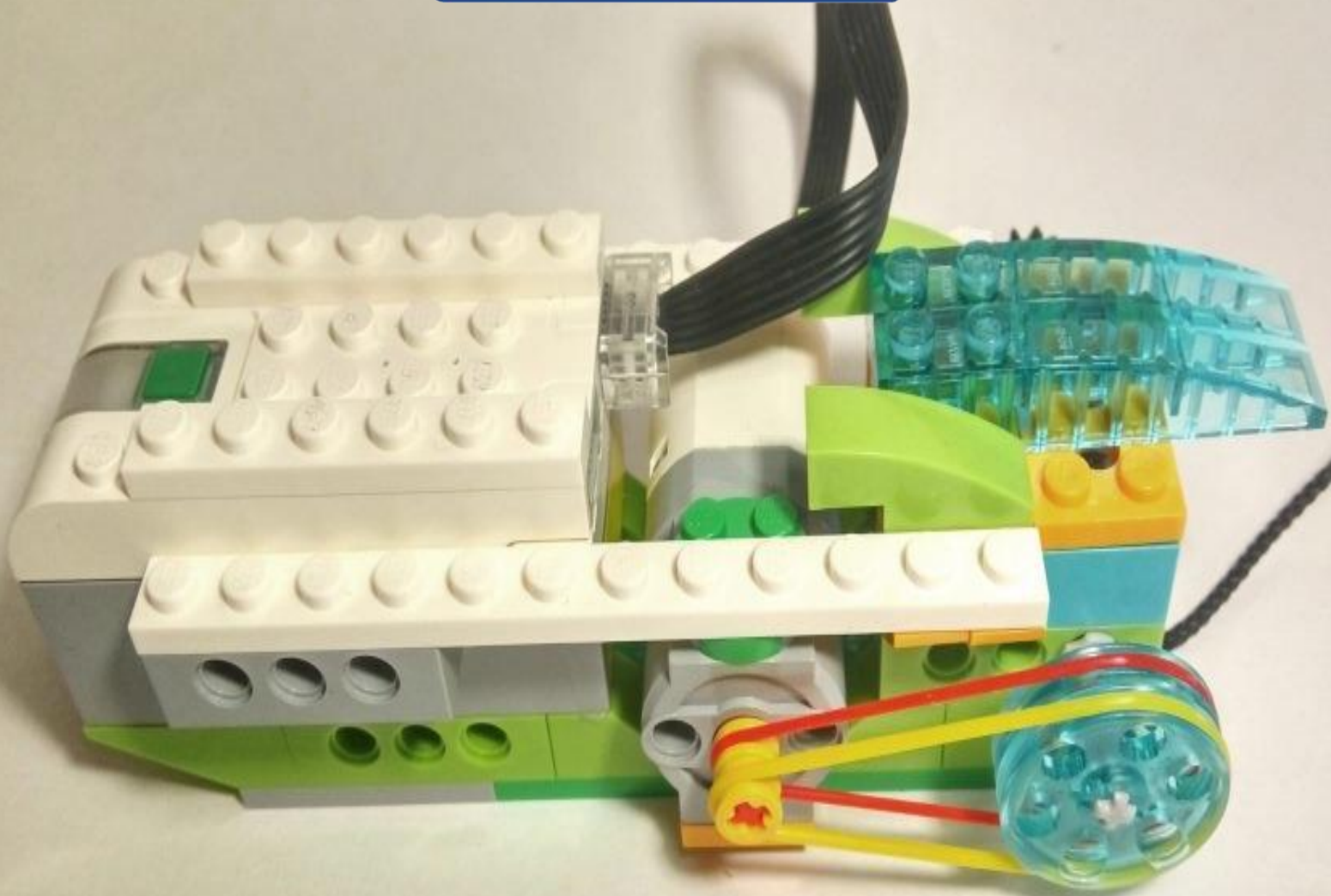









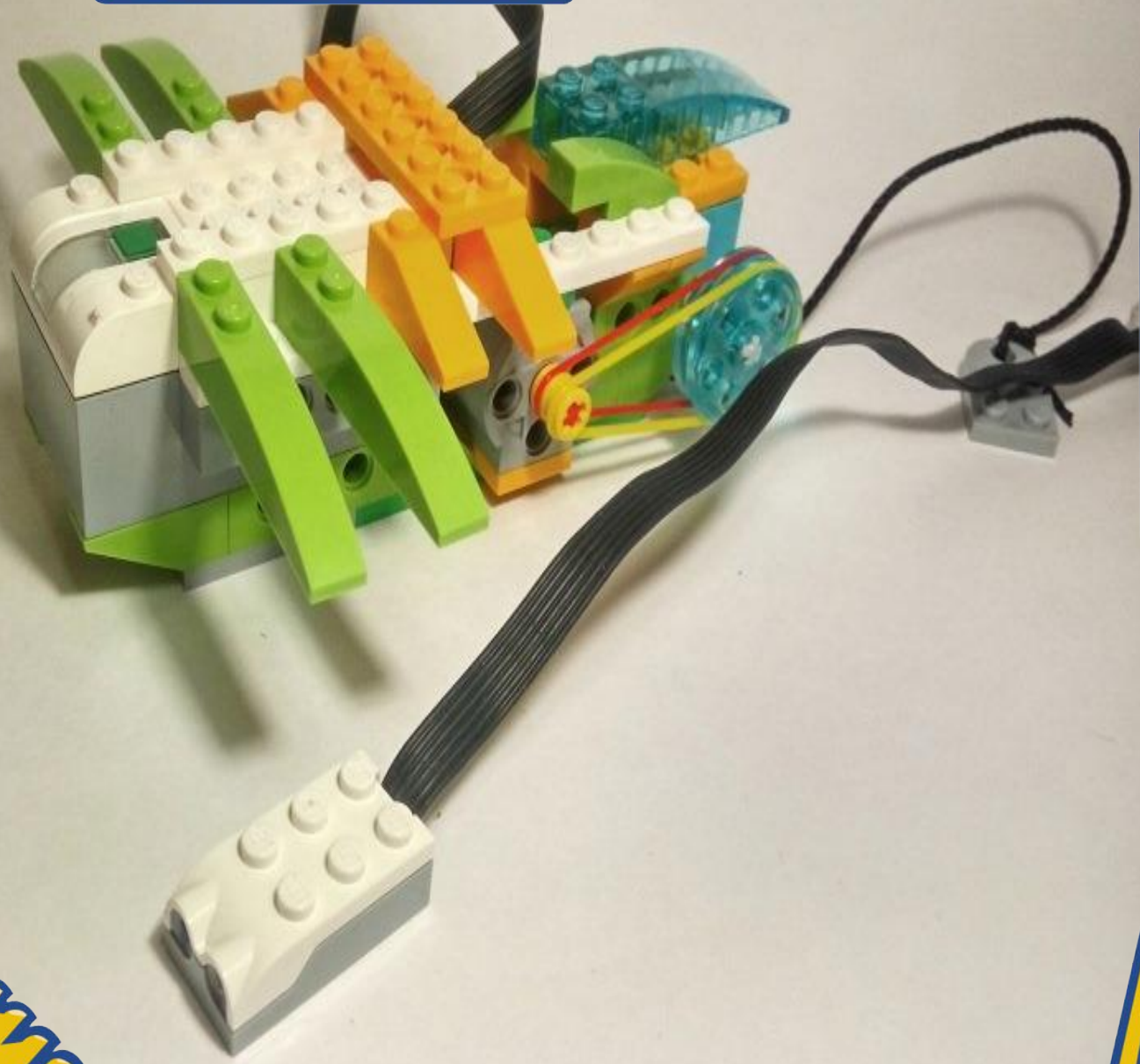



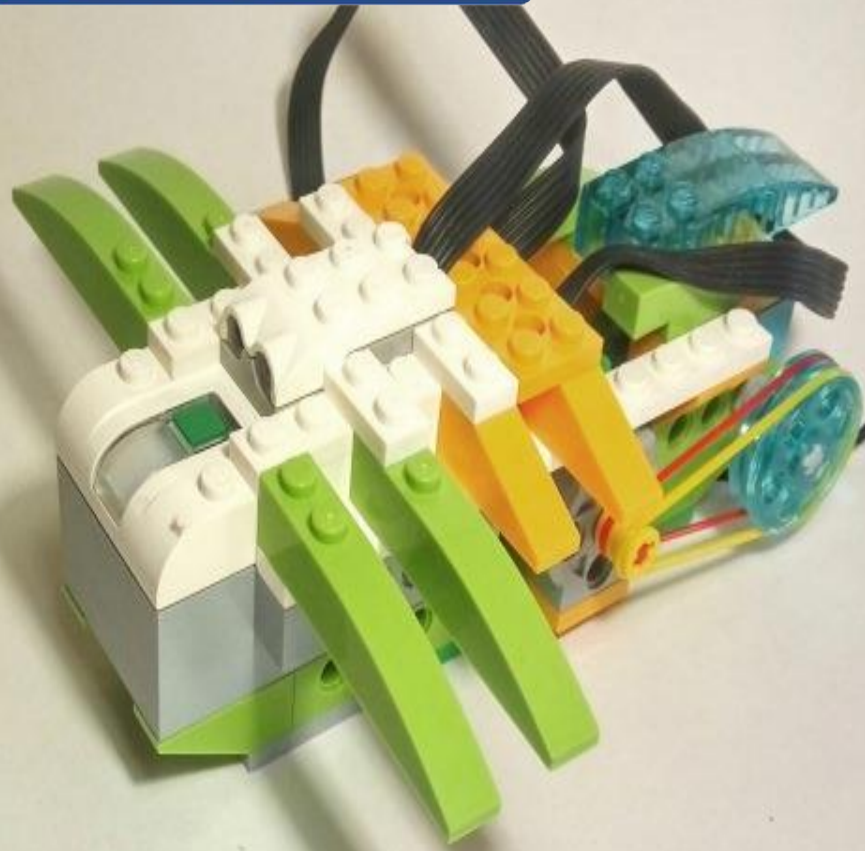

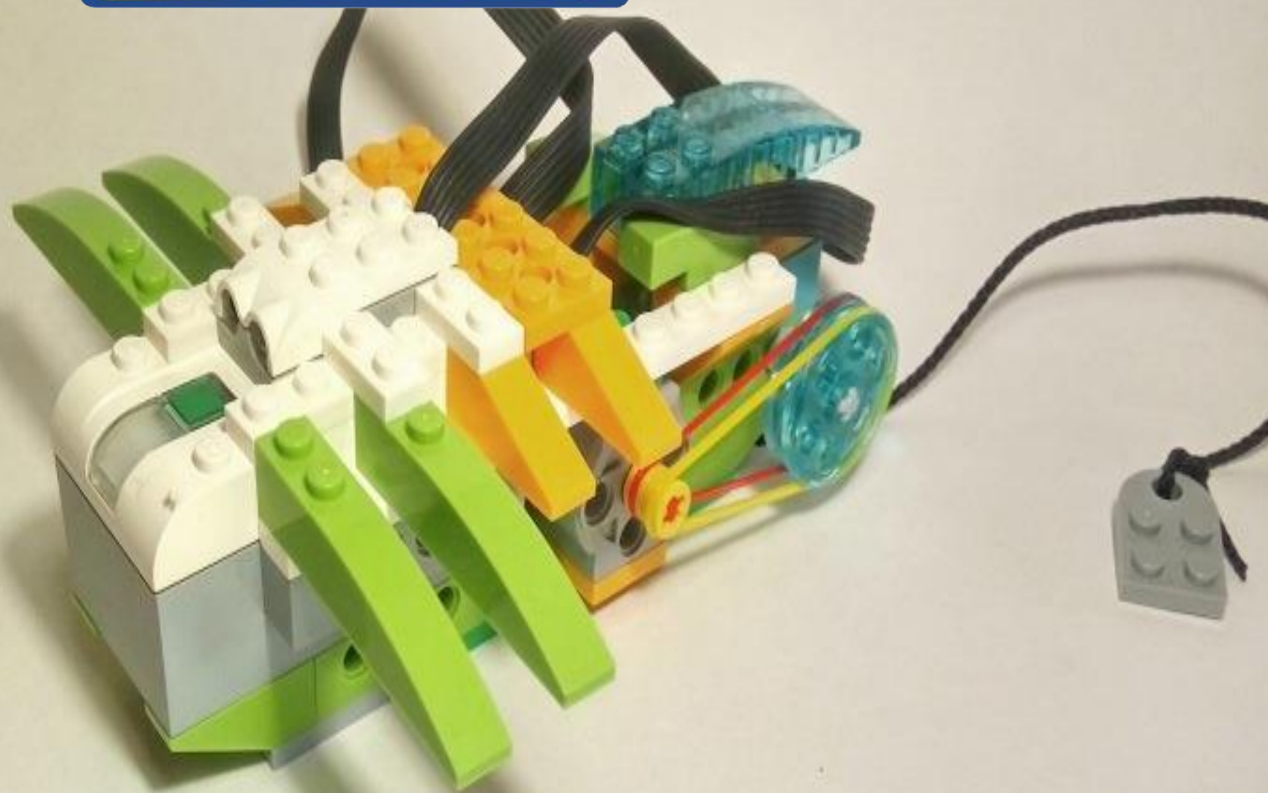

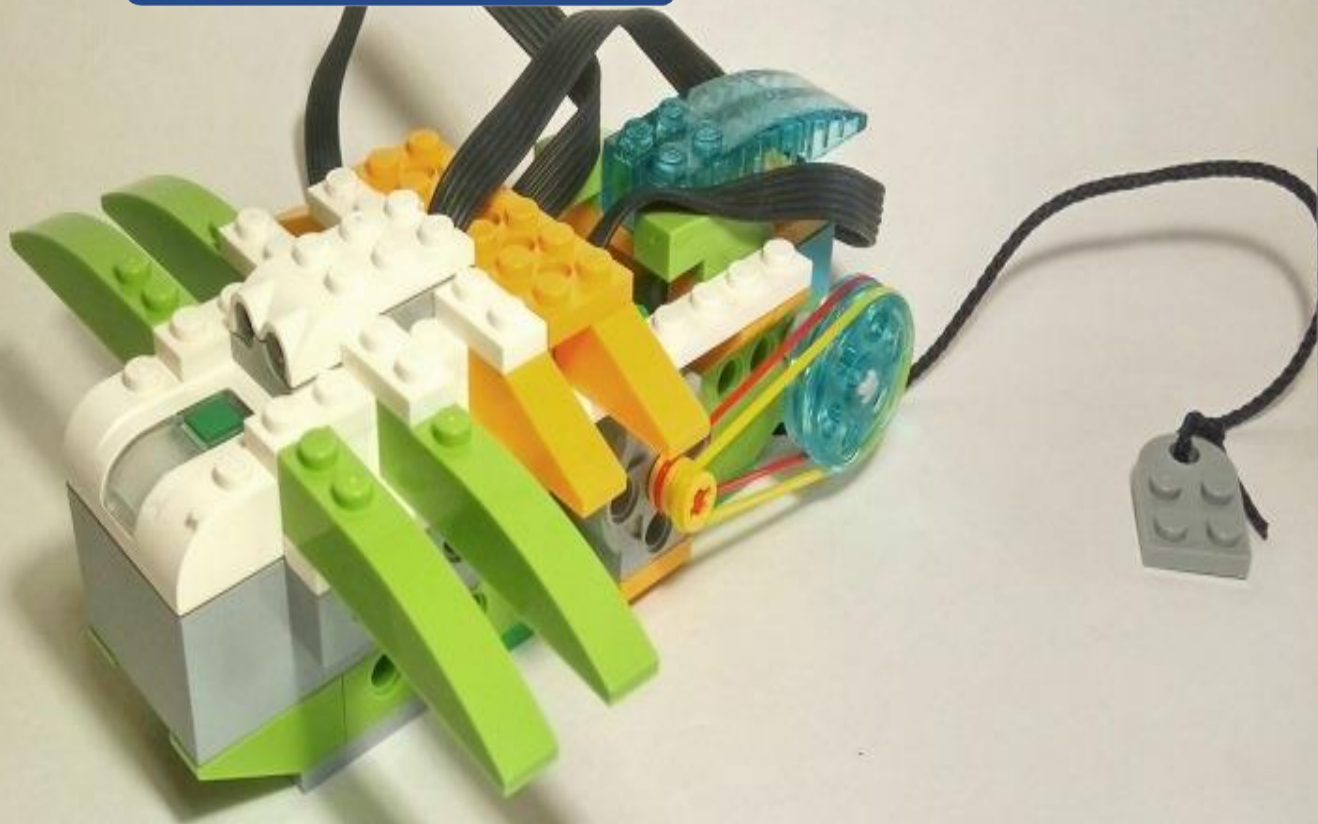

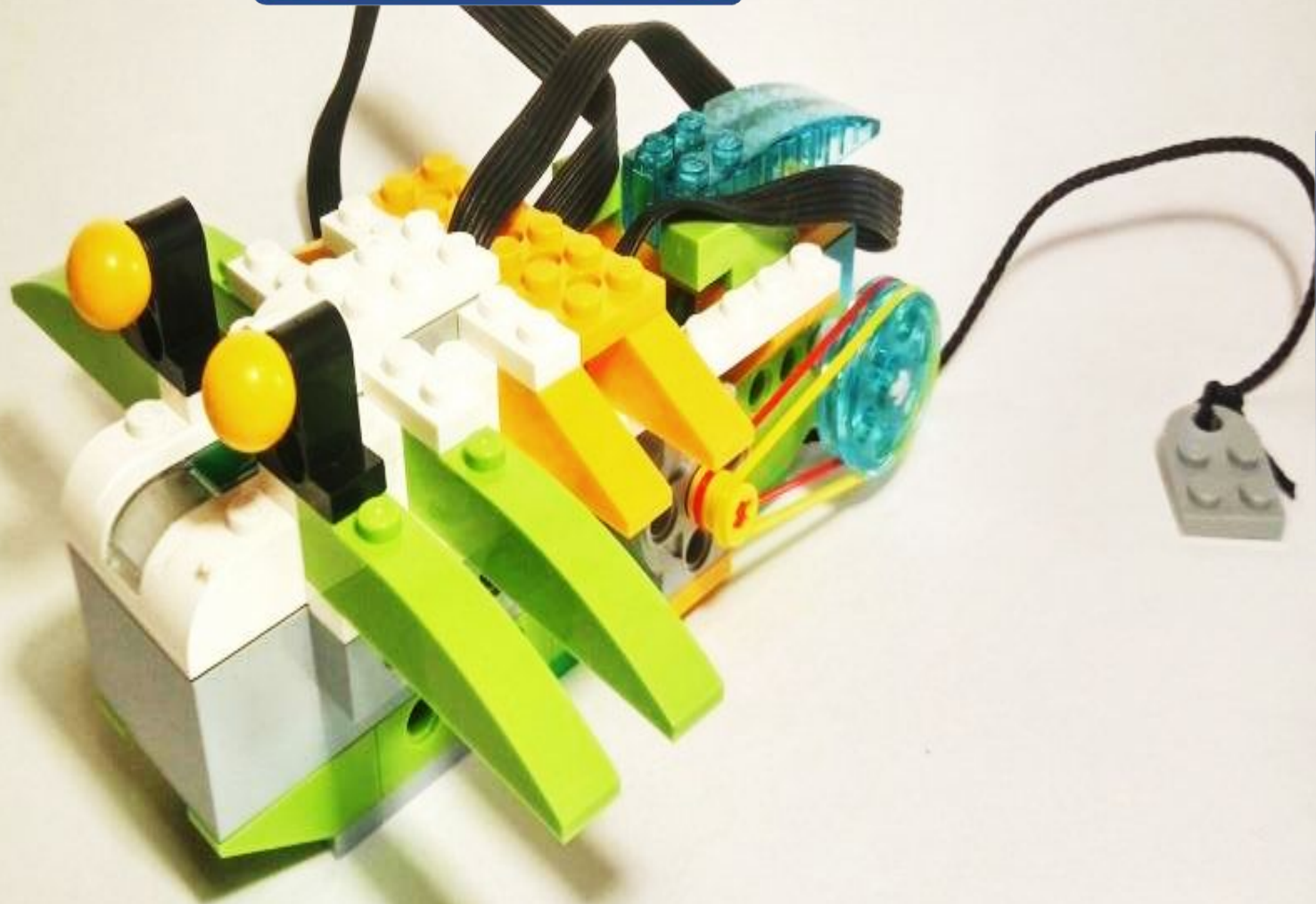



Активация  
Используй

A sequence of seven colored blocks (green and yellow) with icons and numbers, followed by a large yellow block with a refresh icon.

- Block 1: Green, play button icon.
- Block 2: Green, white robot head icon, number 6 in a blue box below.
- Block 3: Green, white robot head icon with a refresh arrow, number 5 in a blue box below.
- Block 4: Green, white robot head icon with an hourglass, number 5 in a blue box below.
- Block 5: Yellow, hourglass icon, orange box below with a white robot head icon and a refresh arrow.
- Block 6: Green, white robot head icon with a refresh arrow, number 5 in a blue box below.
- Block 7: Green, white robot head icon with an hourglass, orange box below with a white robot head icon and a refresh arrow.
- Block 8: Yellow, refresh icon.