

Metālapstrāde



Kur var iegūt metālu?

- ◆ Dabas rūdas
- ◆ Pārkausējot
<https://www.youtube.com/watch?v=1Z3HOIciLak>
- ◆ <https://www.youtube.com/watch?v=2WKUH98jQmM>

Skrūvspīles



Spiles



Bīdmērs

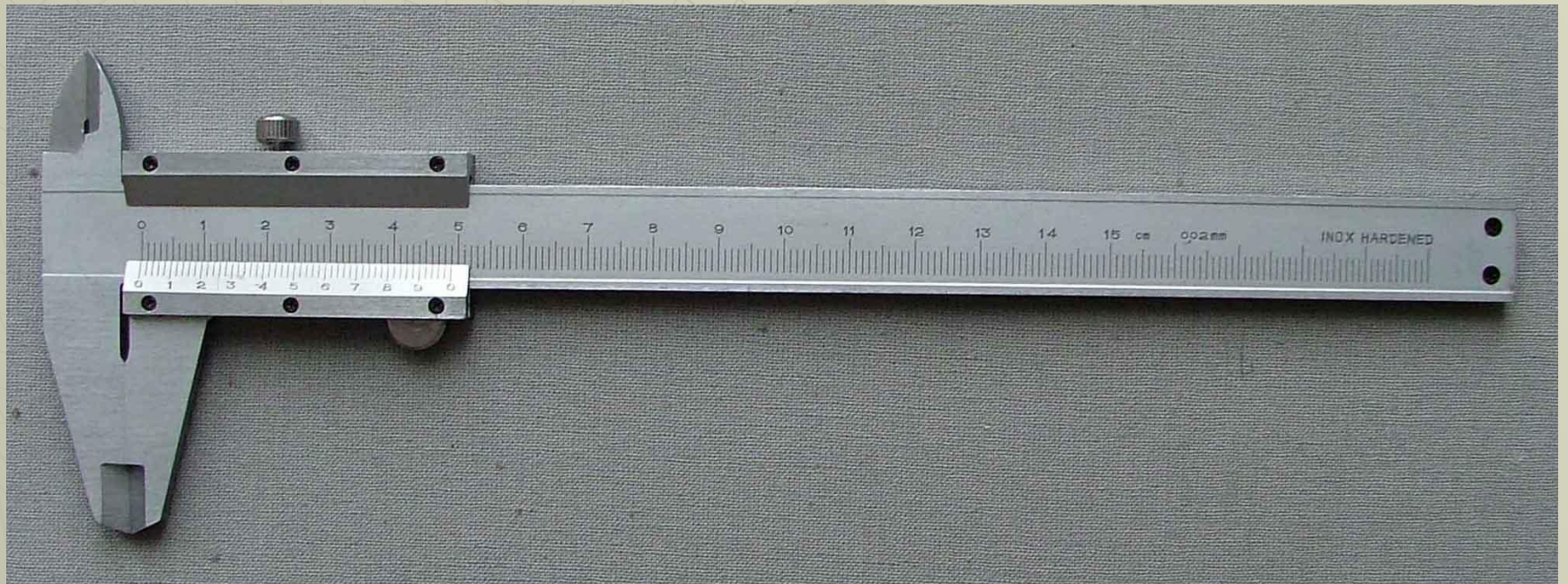

Mikrometers



Āmurs metālam



 **VARU PATS.LV**

Asknaibles un apaļknaibles



Skārda šķēres



Kalts



Slīpmašīna



Lodāmurs



Tecila



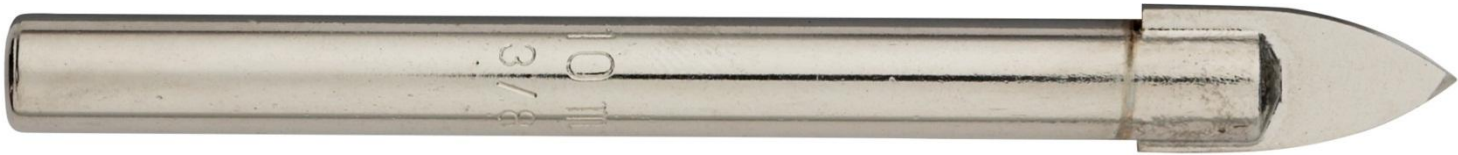

Urbjmašina

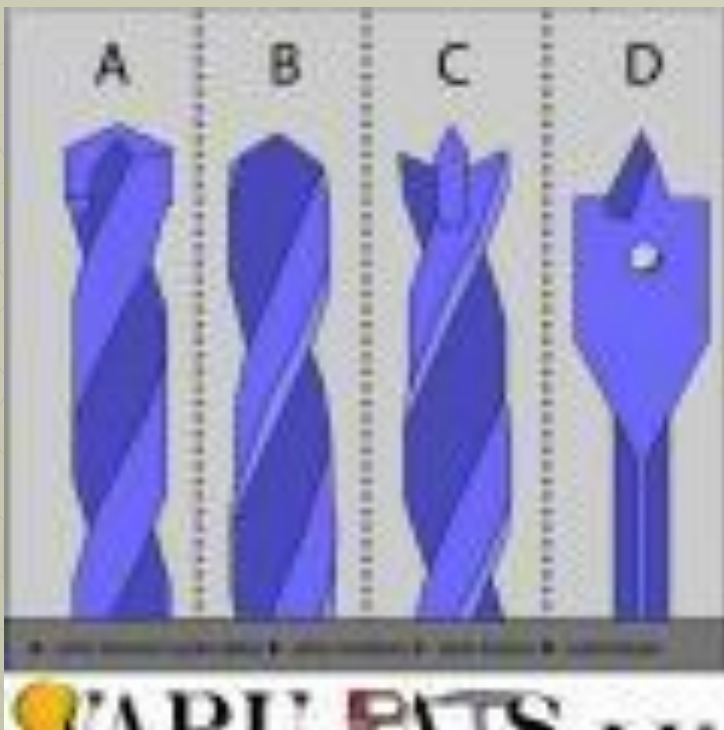

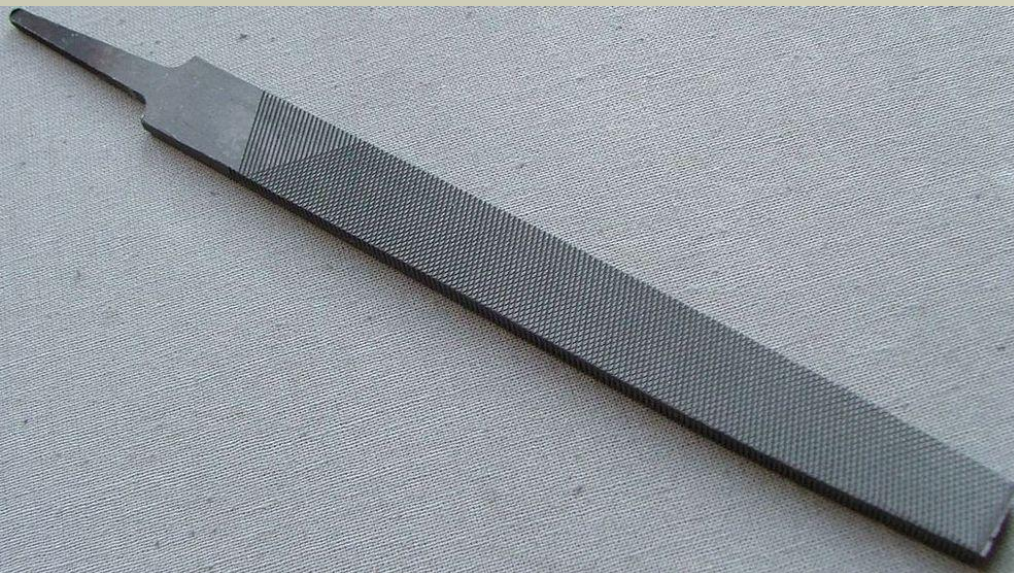

Vīļu uzcirtuma (zobu) veidi

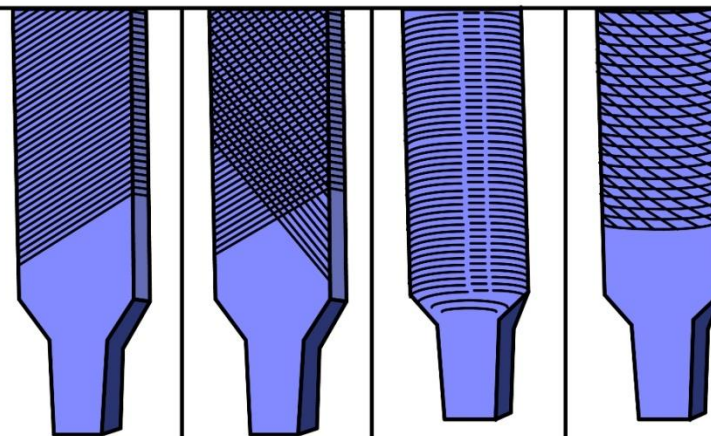

1. Viencirtuma

2. Krustcirtuma

3. Lokcirtuma

4. Punktcirtuma

Vīļu šķērsriezuma veidi

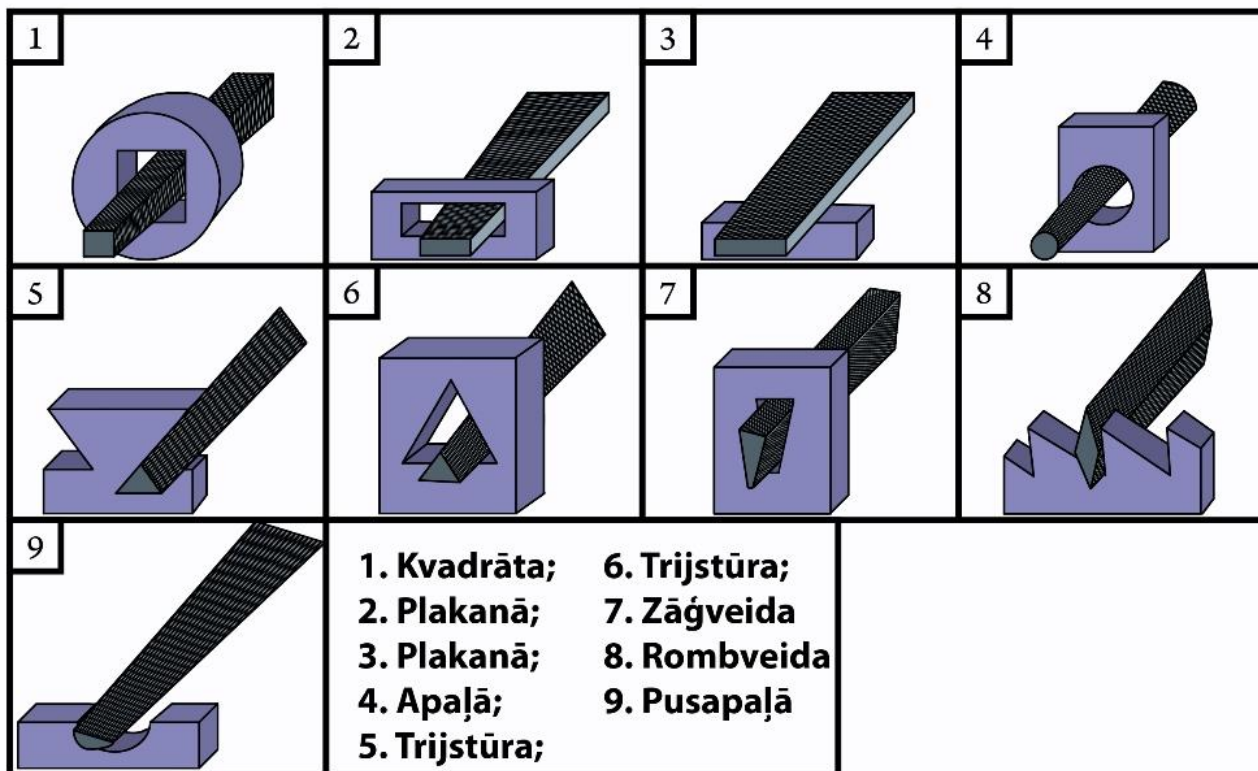

Metāla zāģis



Kniedes

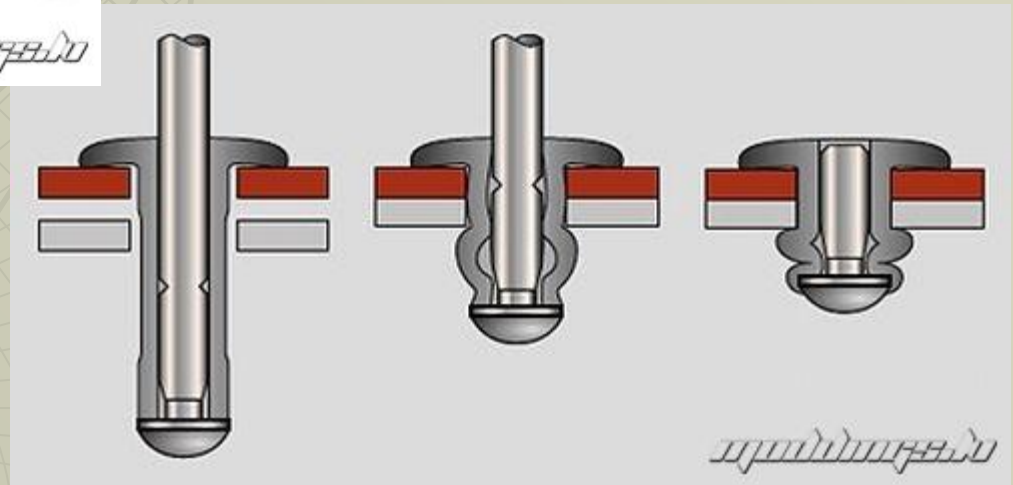

Kniedes



Vītņu griezēju komplekts metālam (vītņurbis un vītņripas)



Atslēdznieka galds



Metāla virpa





Metināšanas
iekārta



- ◆ <https://www.metals.lv/lv/citi-metala-produkti/metalapstrade/> (noskatīties arī video)
- ◆ <https://projektubanka.lv/projects/dekorativametalapstrade>
- ◆