

Pandora Specialist





Быстрый монтаж

Пошаговая установка по готовым настройкам и картам монтажа

Начать монтаж

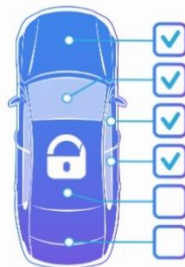

Расширенный монтаж

Детальная настройка и проверка состояния системы

Начать монтаж



Настройка GPS маяка

Проверка состояния и настройка параметров GPS маяка Nav

Начать настройку



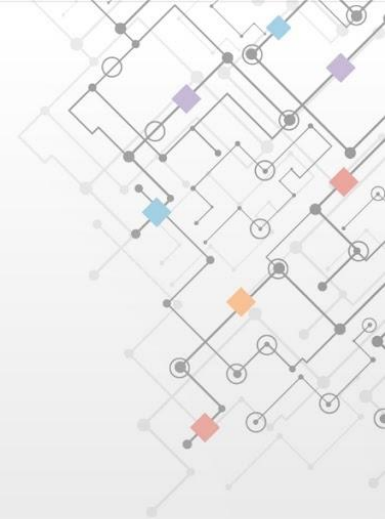
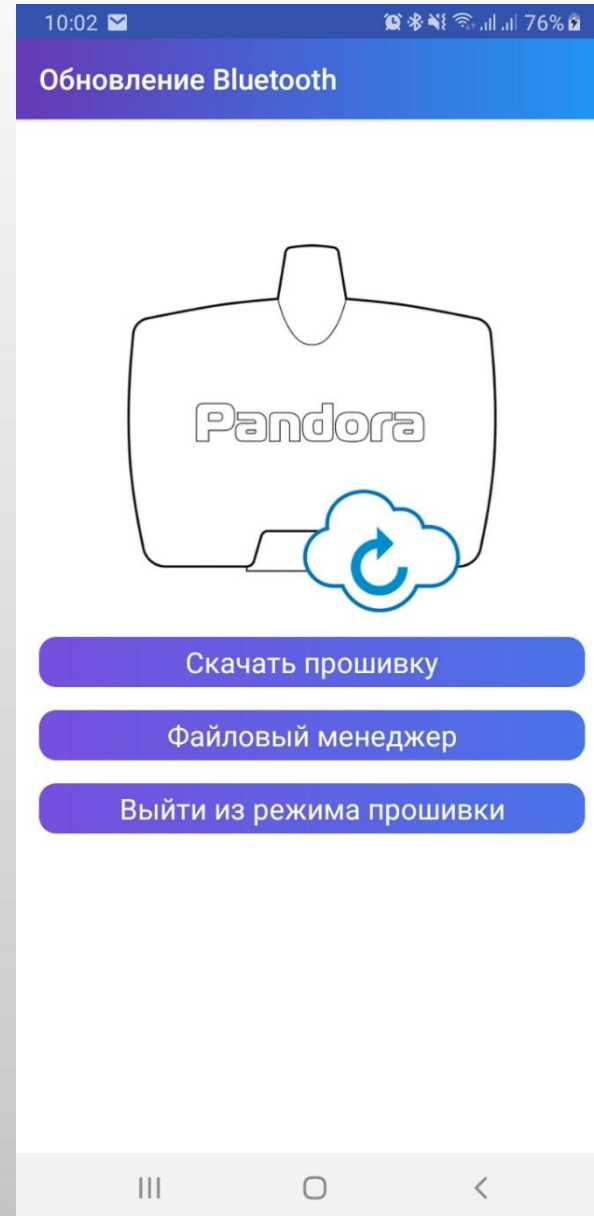
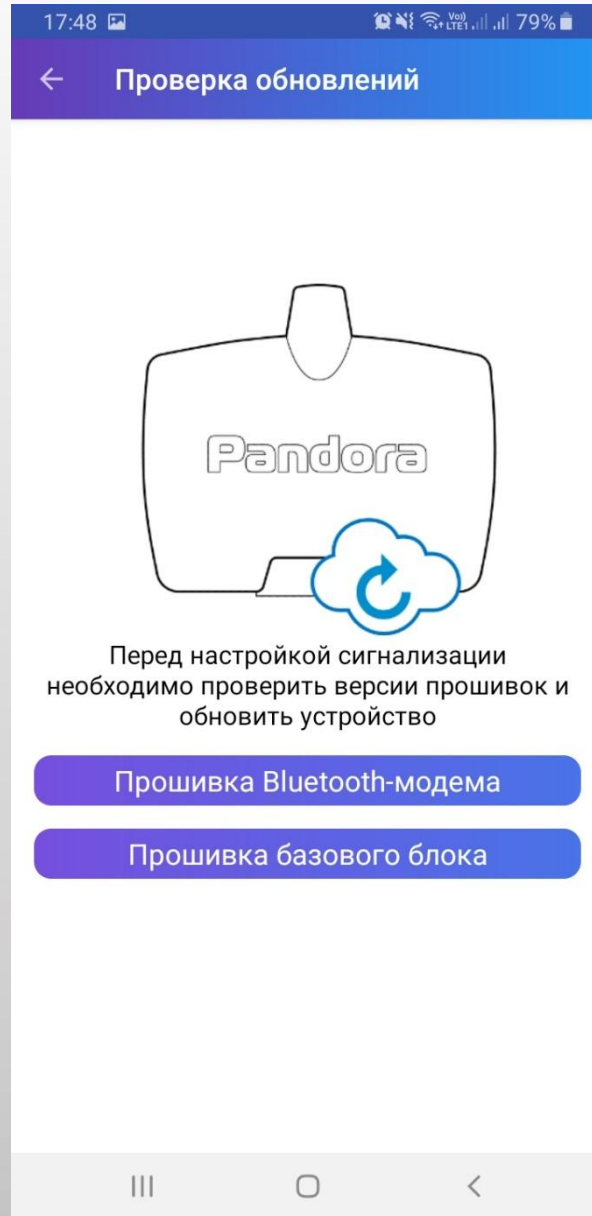
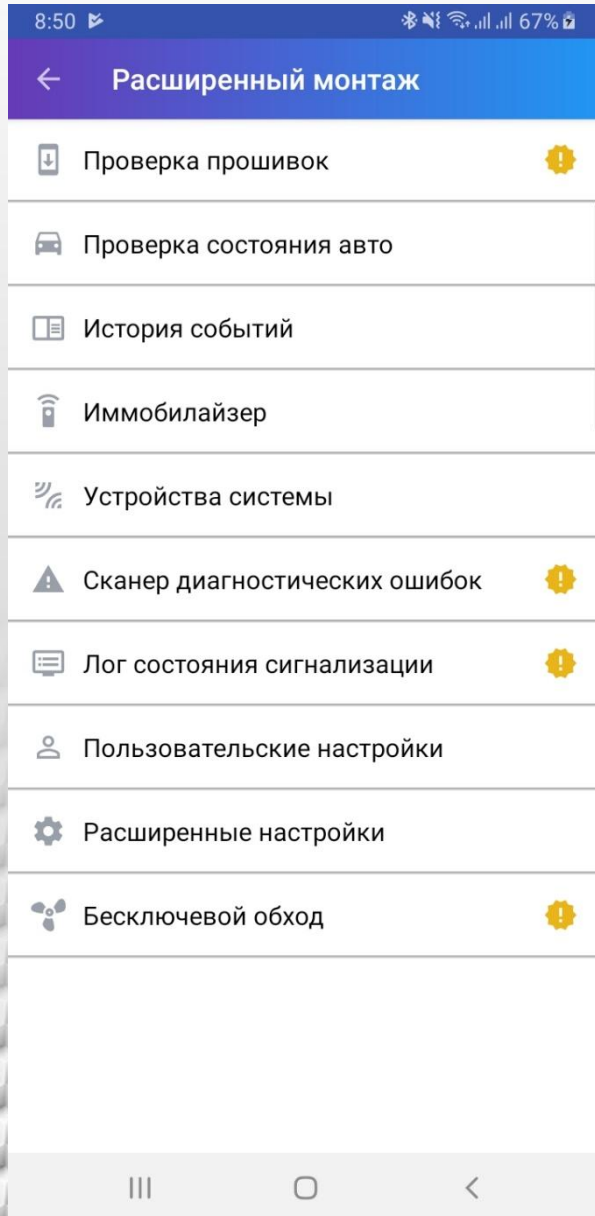

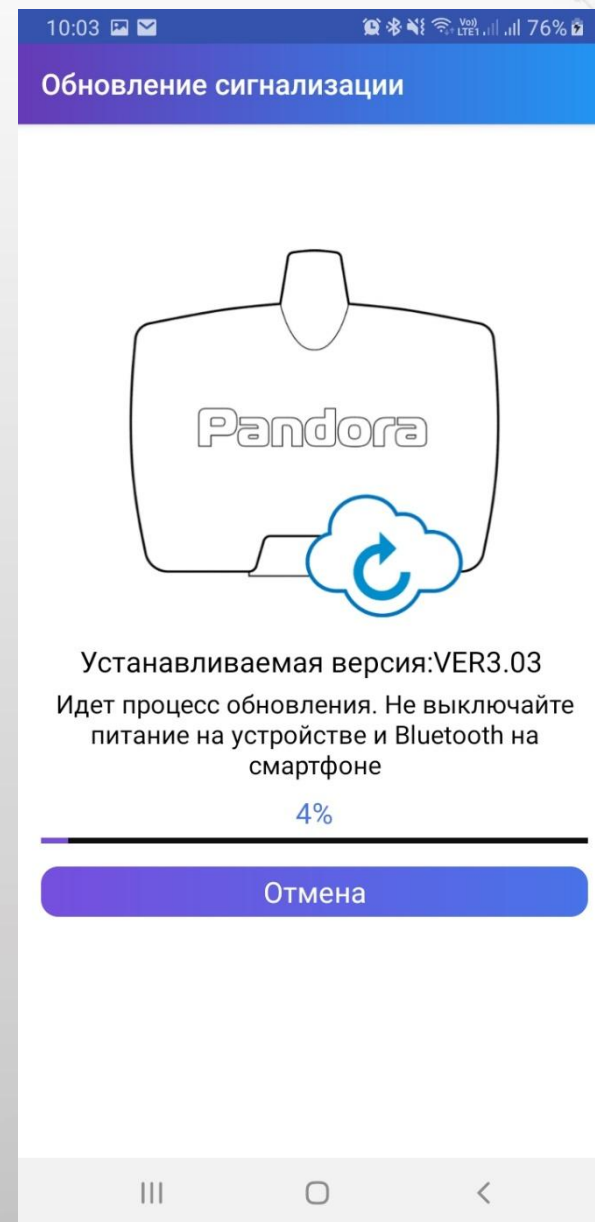
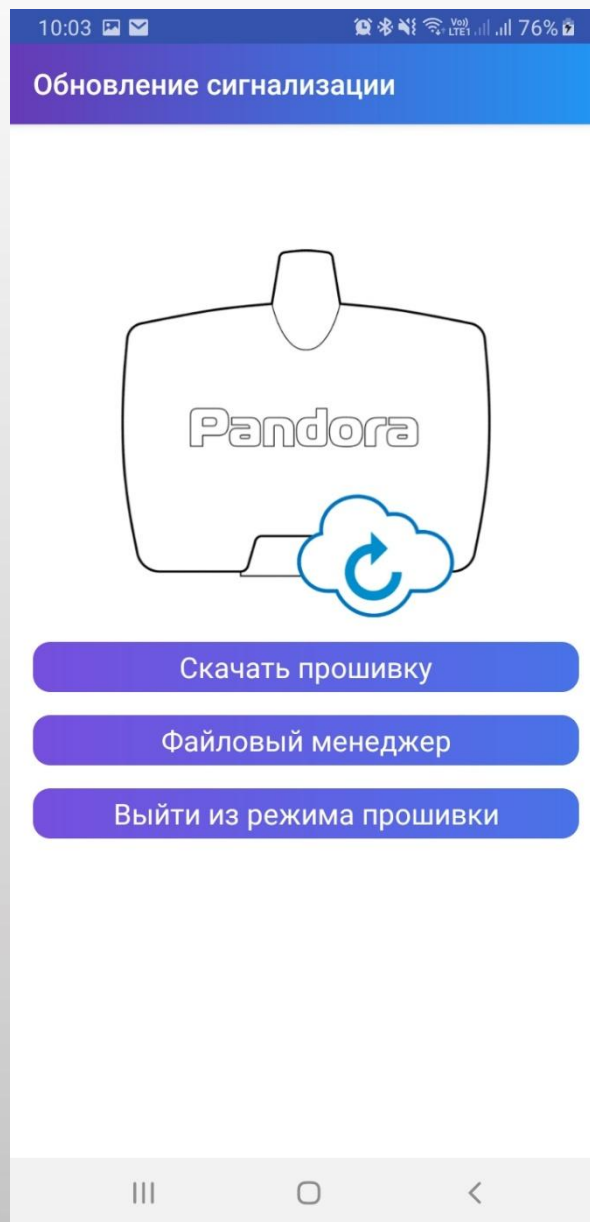
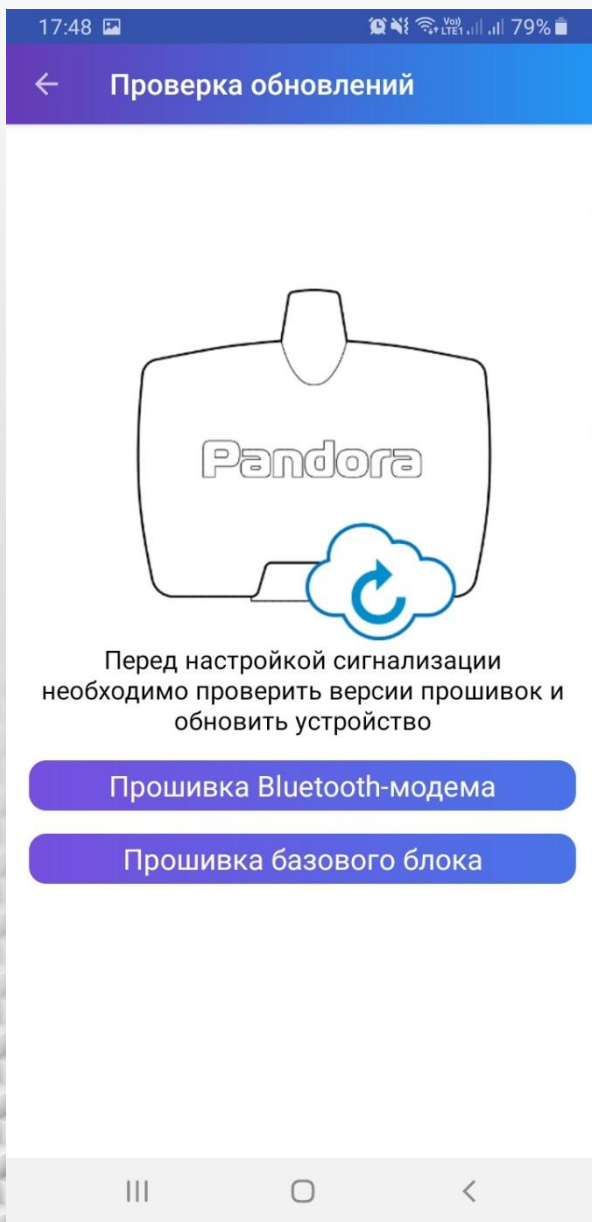

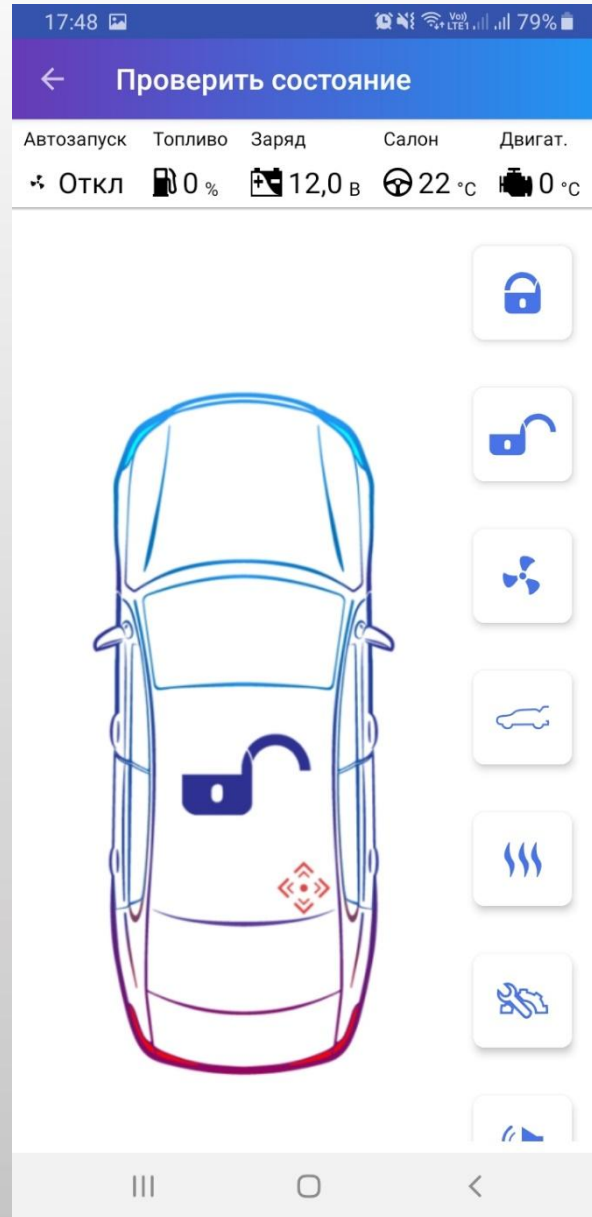
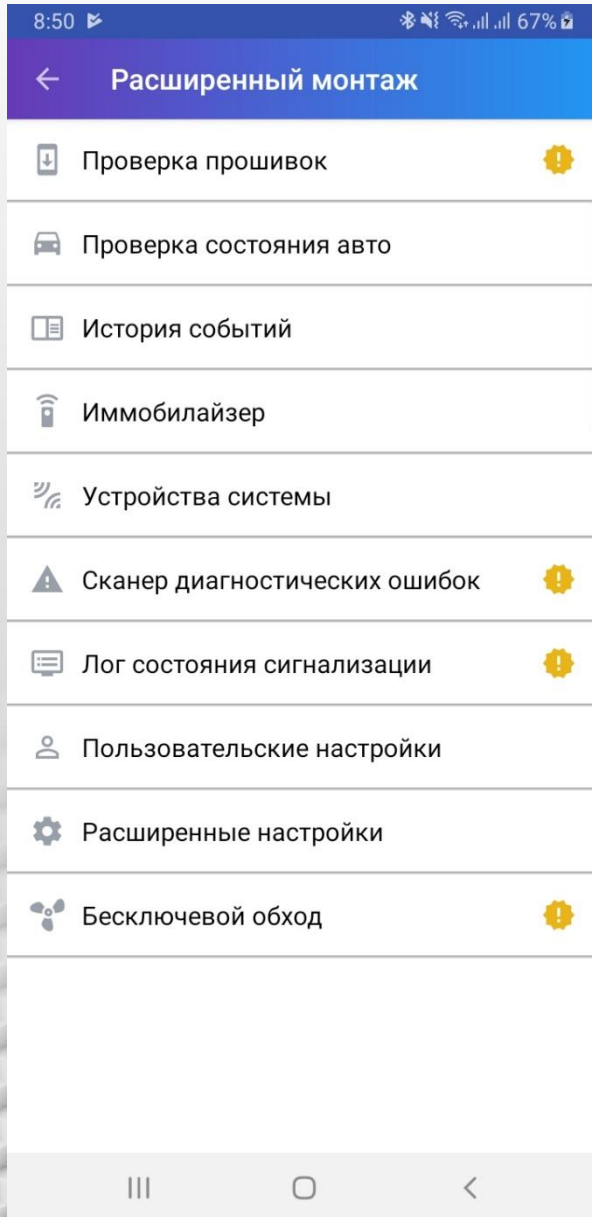

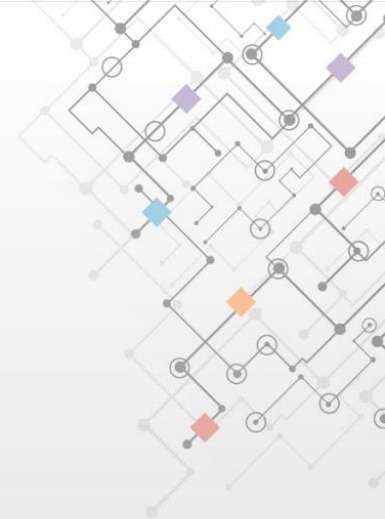
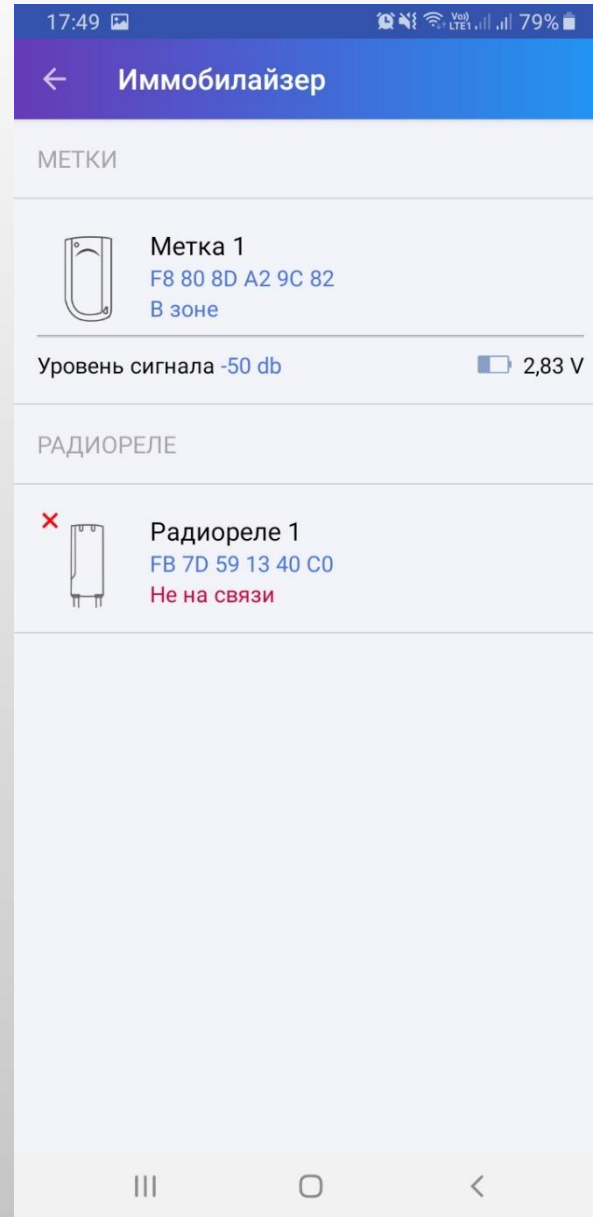
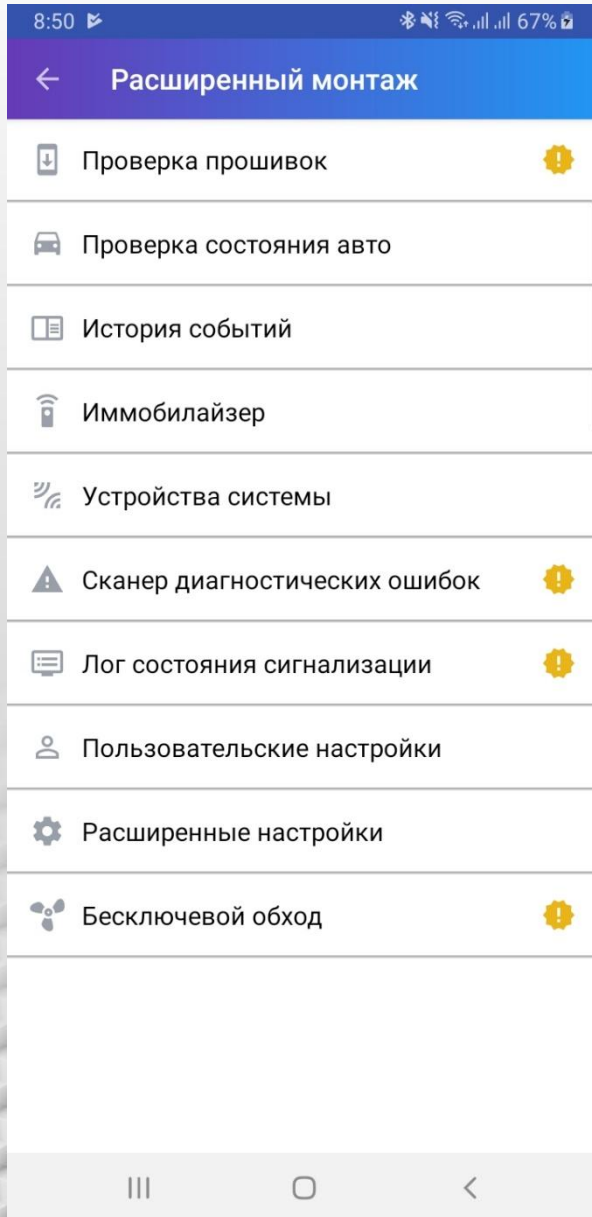

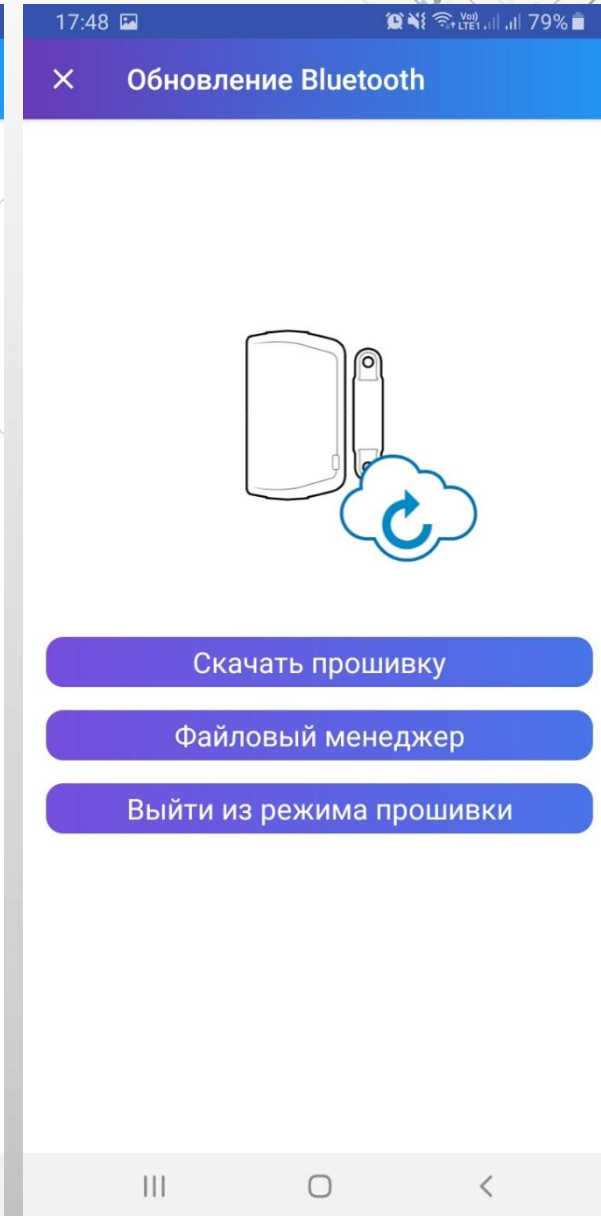
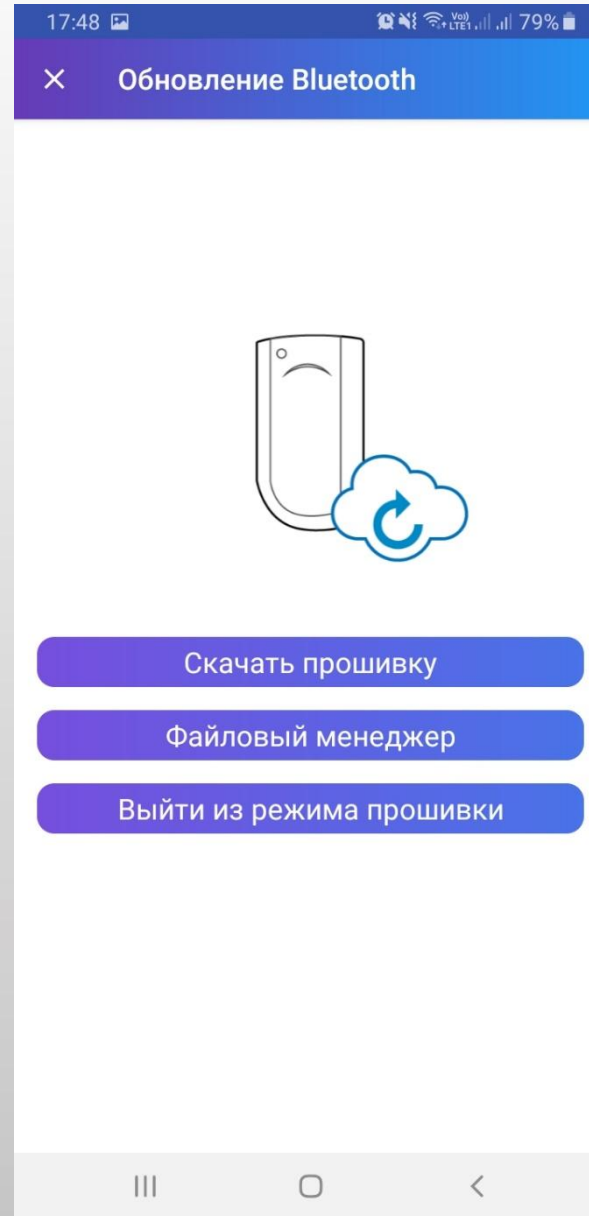
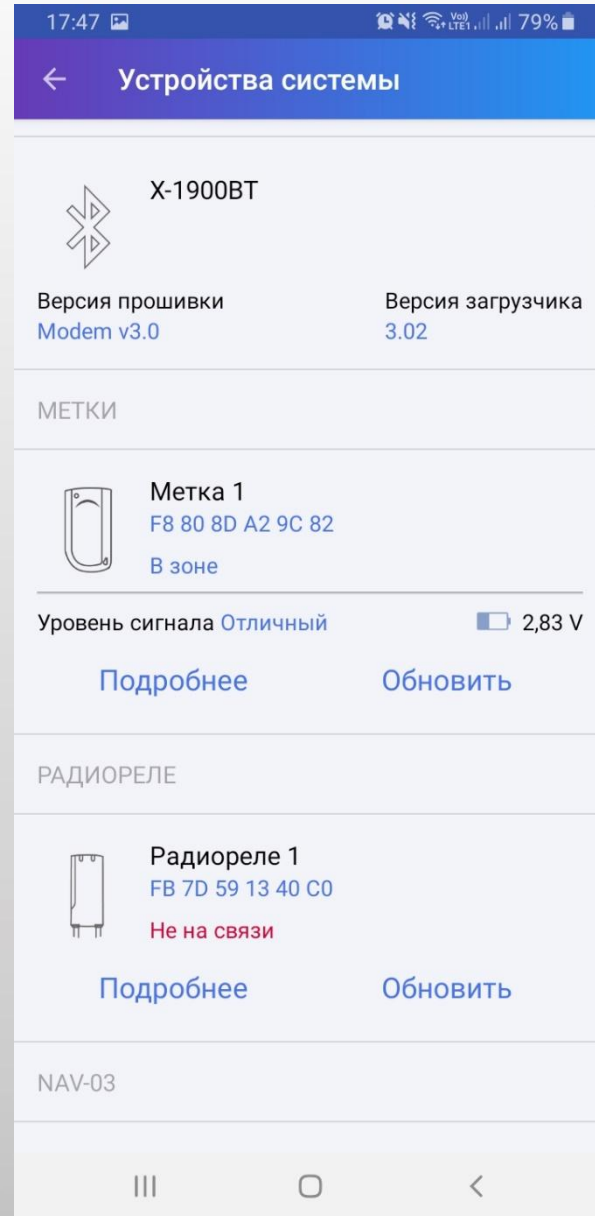
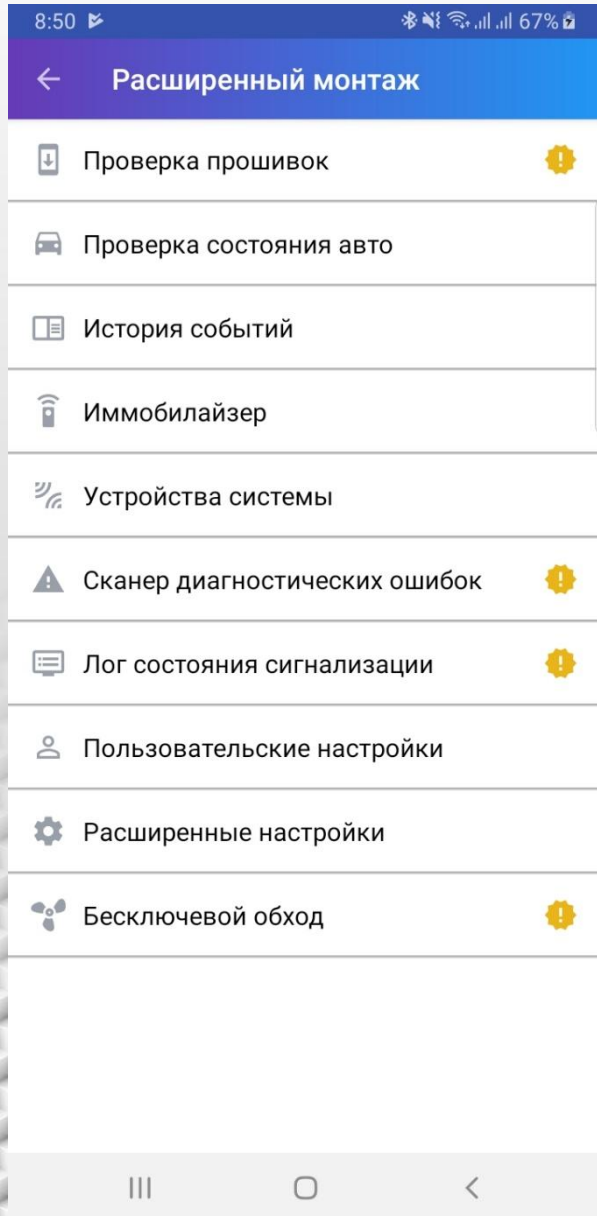

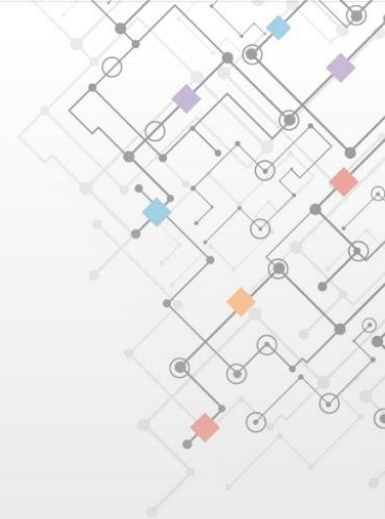
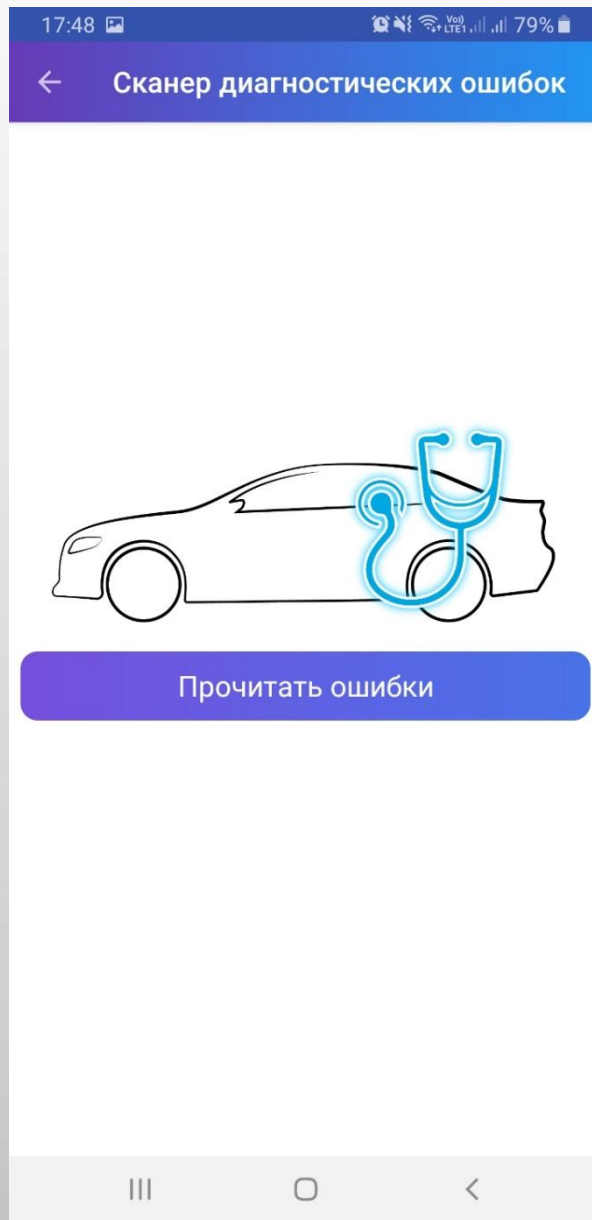
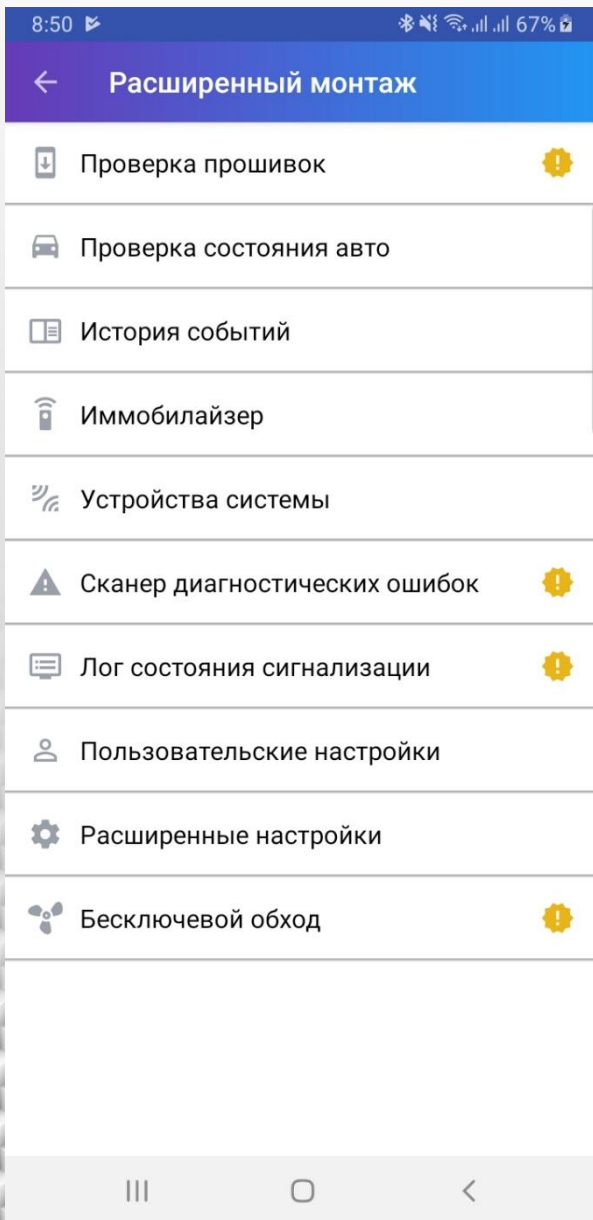

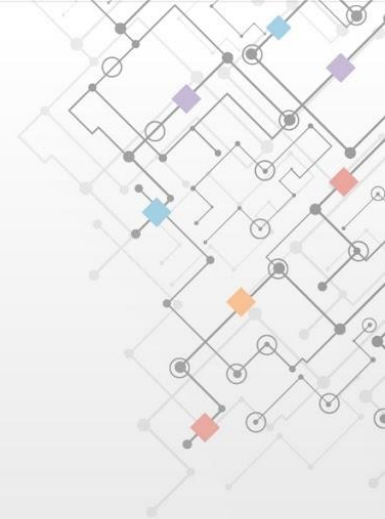
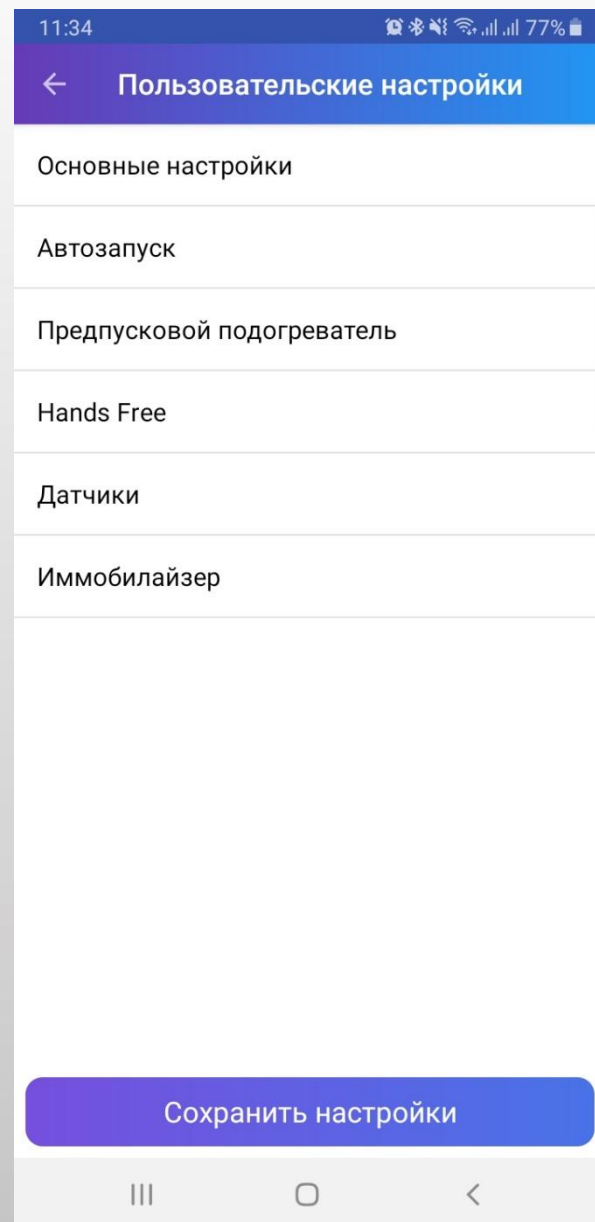
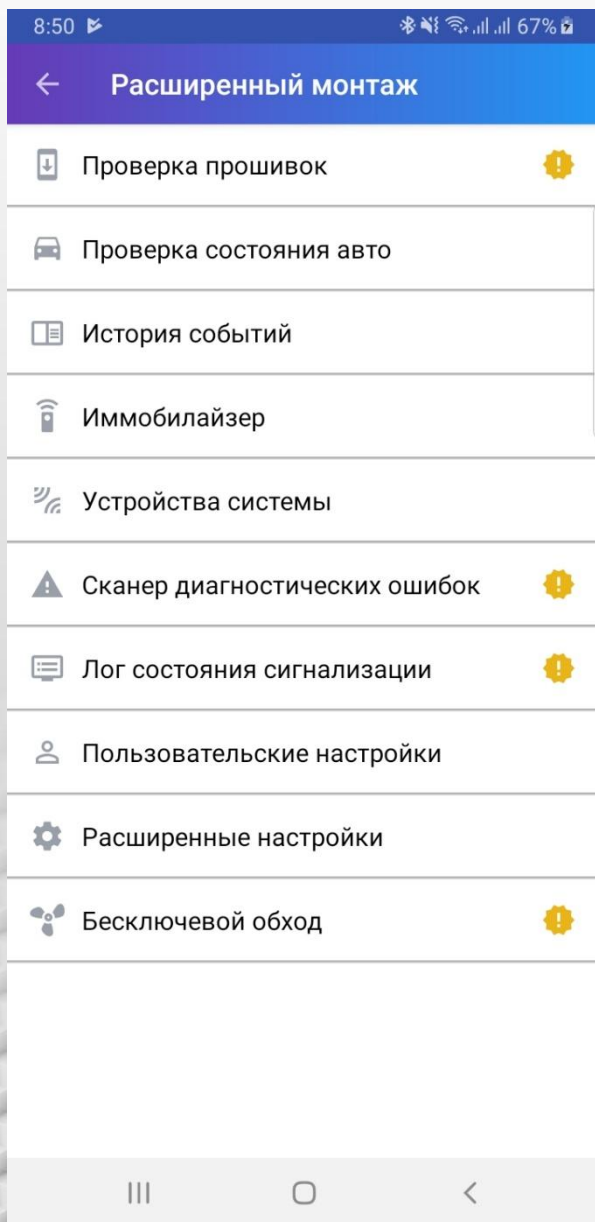

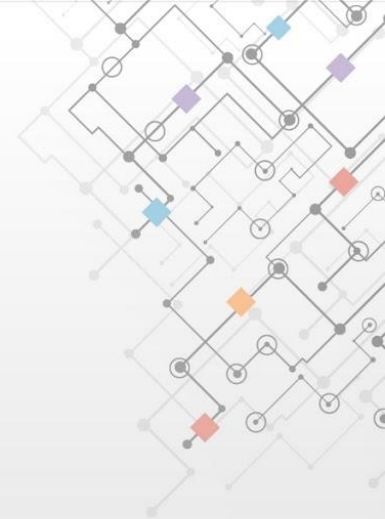
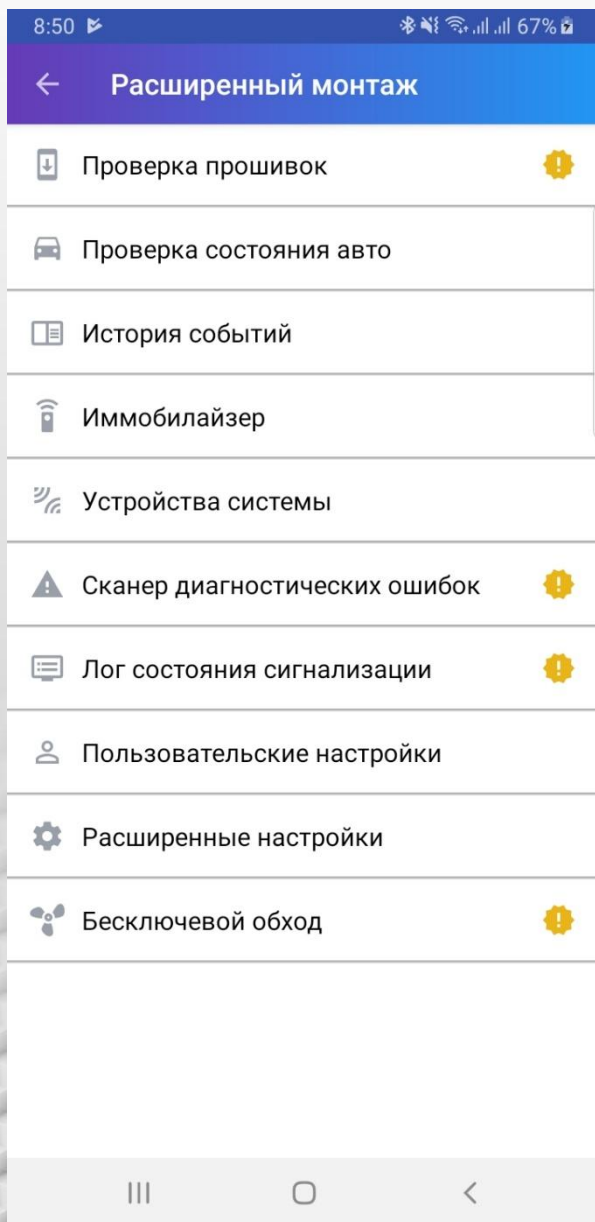

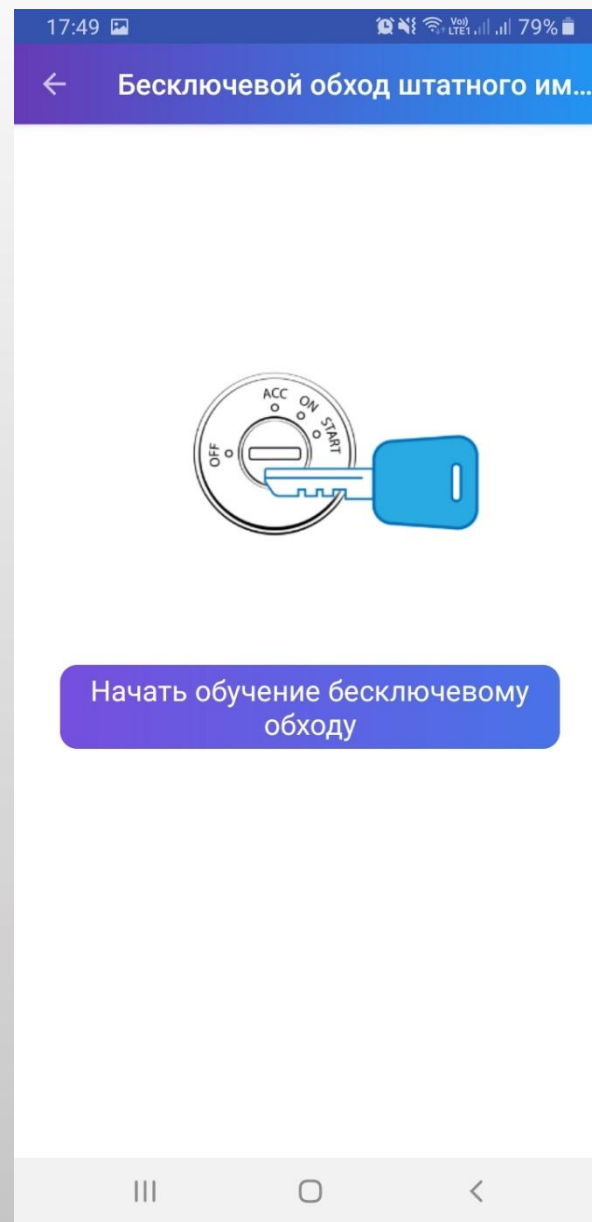
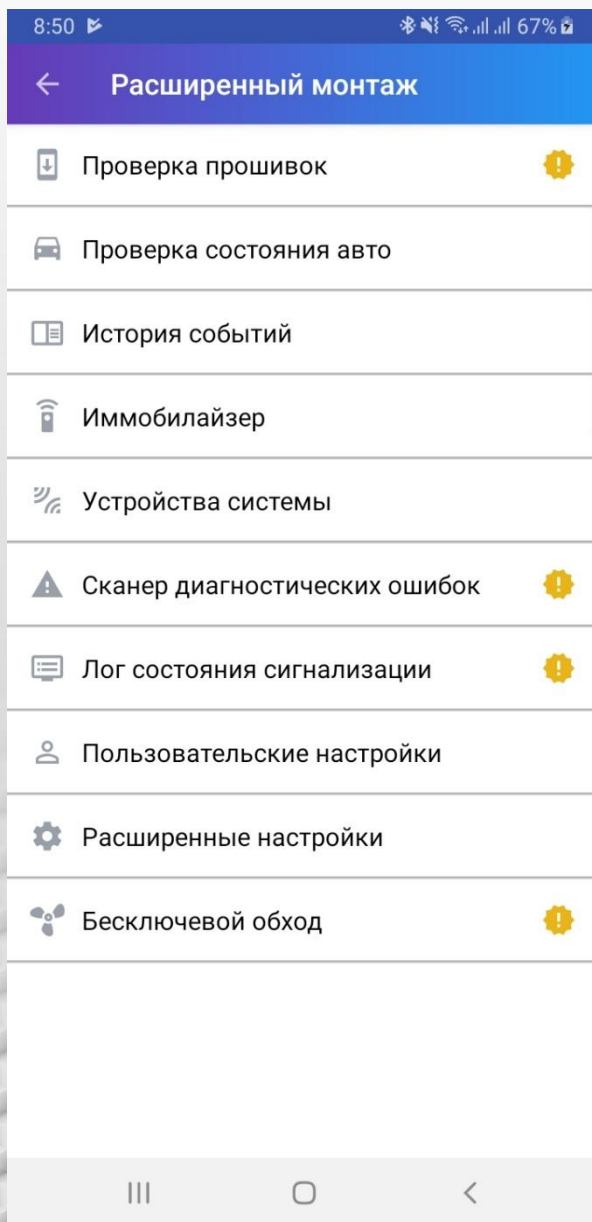

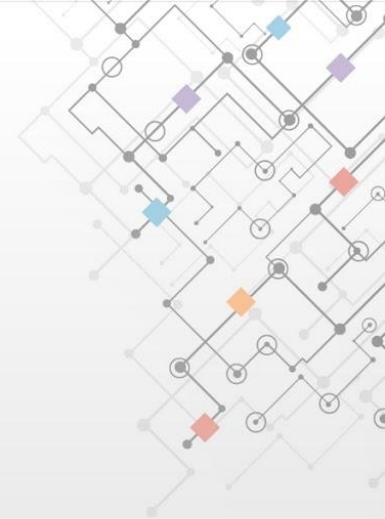

Обход Toyota imo_imi v3



Интеллектуальное зарядное устройство автомобильных аккумуляторов

- зарядный ток до 25 А с контролем напряжения
- встроенные алгоритмы обслуживания АКБ
- автоматическое слежение в бортсети автомобиля при техническом обслуживании
- программирование и статистика на смартфоне – Bluetooth 4.2

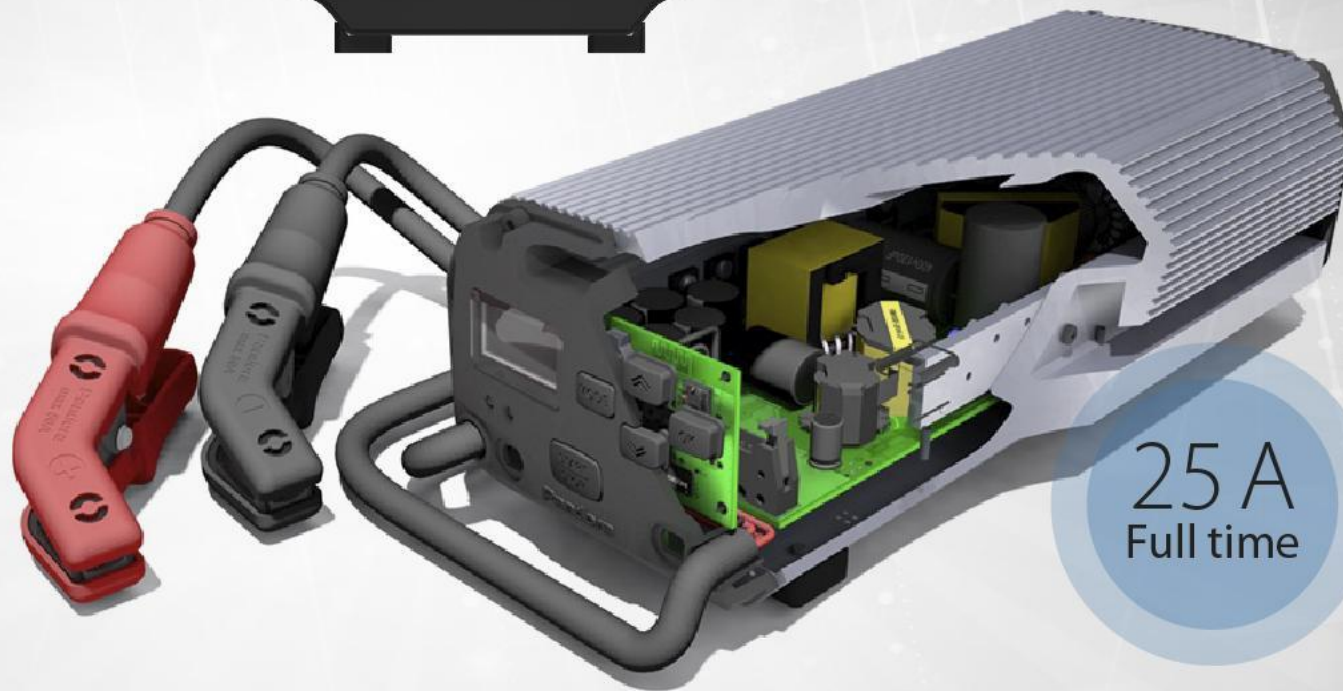

25 A
Full time

MegaFon #1 72% 17:56

Главная

00:00:00
Напряжение
0 В
Ток заряда/Ток разряда
0 А / 0 А

Заряд выключен

Тип батареи: --
Режим заряда: --

Емкость: --
Отданная энергия: 0,0 А*ч

ЗАРЯД **СЕРВИС**

MegaFon #1 72% 17:56

Главная

00:00:00
Напряжение
0 В
Ток заряда/Ток разряда
0 А / 0 А

Заряд

Команды сервиса

- Booster
- Тренировка

ЗАКРЫТЬ **ОК**

Тип батареи: --
Режим заряда: --

Емкость: --
Отданная энергия: 0,0 А*ч

ЗАРЯД **СЕРВИС**

MegaFon #1 83% 12:34

Отчет по тренировке

2,62 А
Сила тока

14,56 В
Напряжение

17,9 А*ч
Емкость

Длительность первичного заряда: 00:00:26
Длительность разряда: 00:01:14
Длительность финишного заряда: 00:01:43

Заряд, отданный при первичном заряде: 3,0 А*ч
Заряд, отданный при финишном заряде: 9,4 А*ч

График всего процесса