

# ИННОВАЦИИ В ОБЛАСТИ ПРИГОТОВЛЕНИЯ АБС

Инновации установок циклического действия

Инновации установок непрерывного действия



# LINTEC GMBH&CO.KG





LINTEC CSD 1200

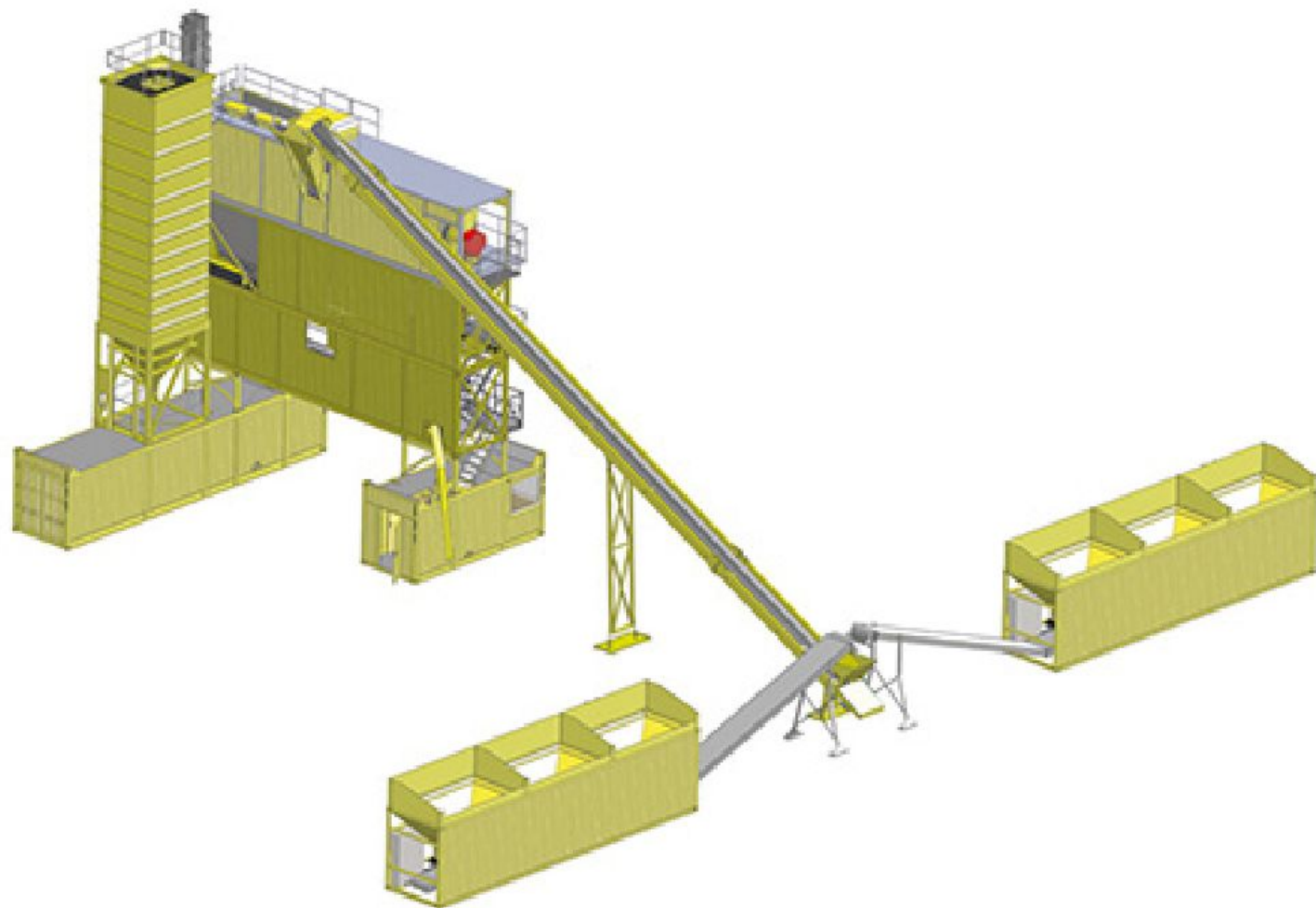

LINTEC CSD 2500 / 2500 B



## СОРТИРОВОЧНО-СУШИЛЬНЫЙ БАРАБАН LINTES

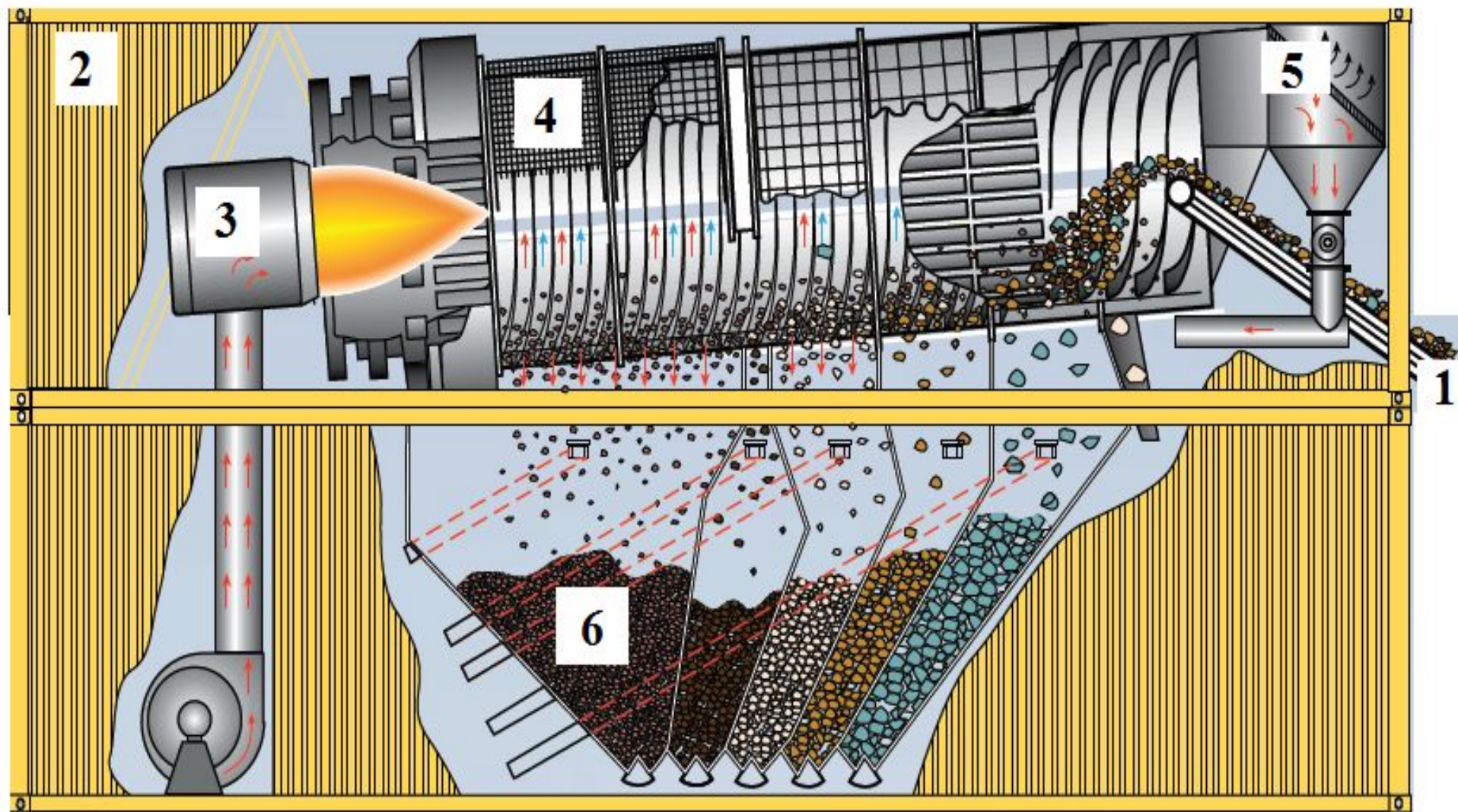







# BERNARDI





ТРАДИЦИОННАЯ ТЕХНОЛОГИЯ ХРАНЕНИЯ  
И ДОЗИРОВАНИЯ ИНЕРТНЫХ МАТЕРИАЛОВ

*Материалы BENNINGHOVEN*

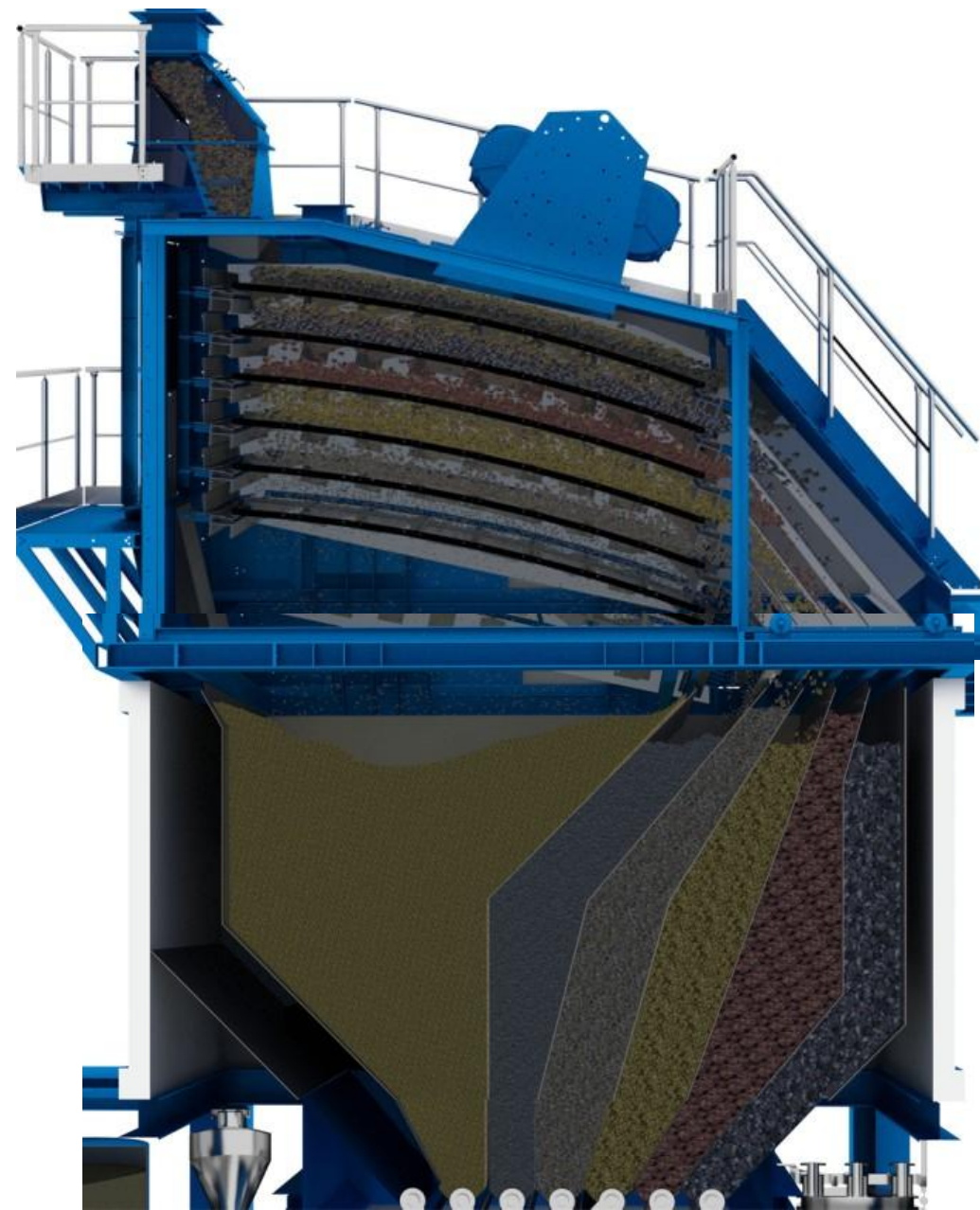



# ТРАДИЦИОННАЯ ТЕХНОЛОГИЯ ХРАНЕНИЯ И ДОЗИРОВАНИЯ ИНЕРТНЫХ МАТЕРИАЛОВ

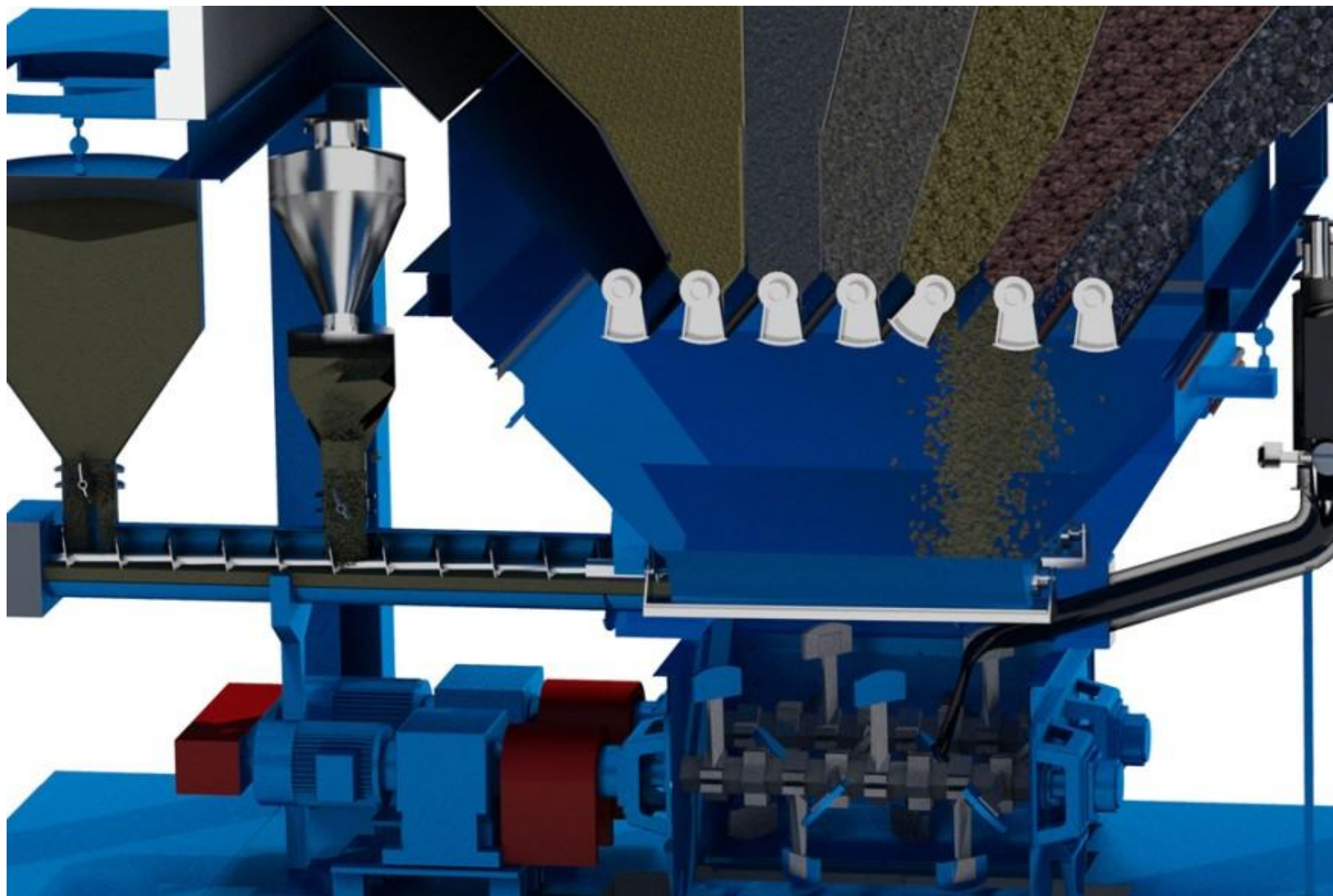



# ТЕХНОЛОГИЯ ХРАНЕНИЯ И ДОЗИРОВАНИЯ ИНЕРТНЫХ МАТЕРИАЛОВ BERNARDI MET

*MET (Multi Ecological Tower)*

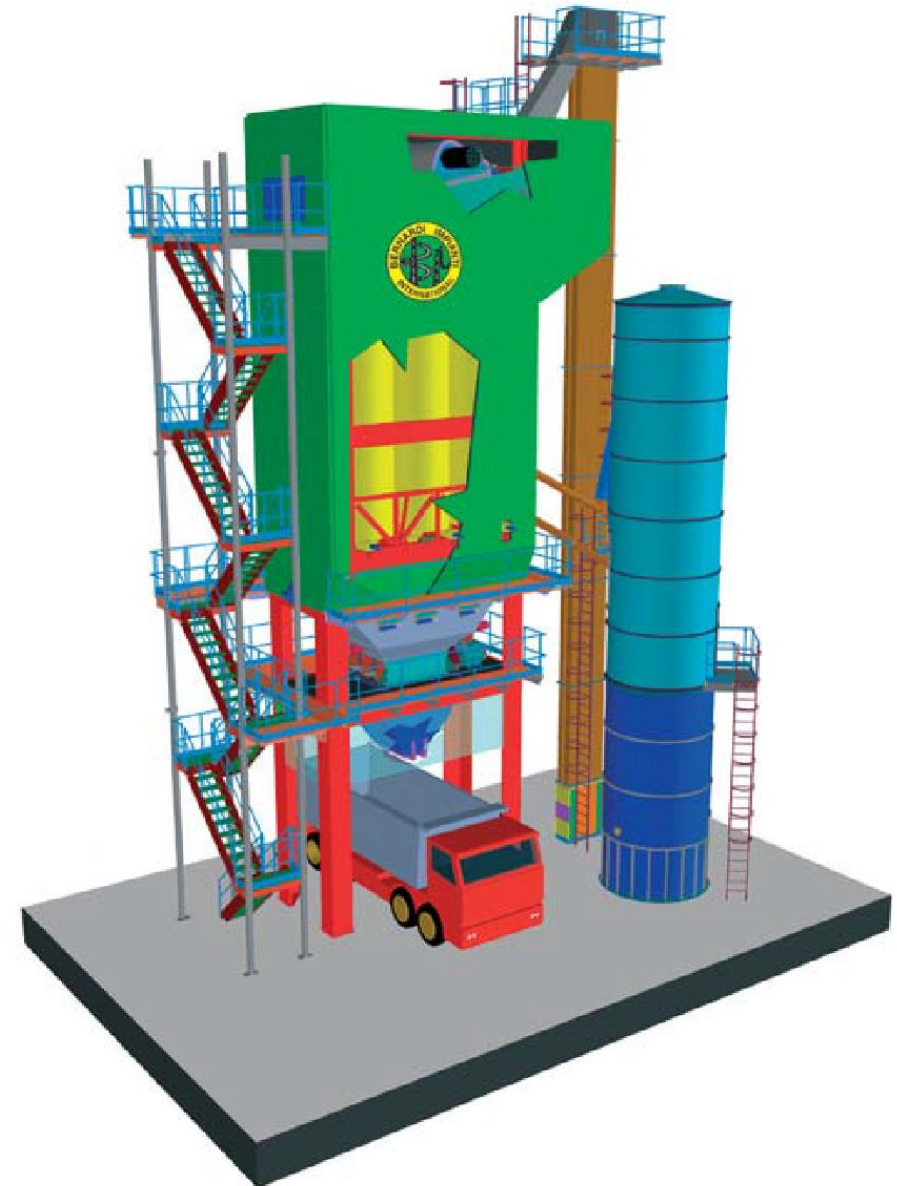
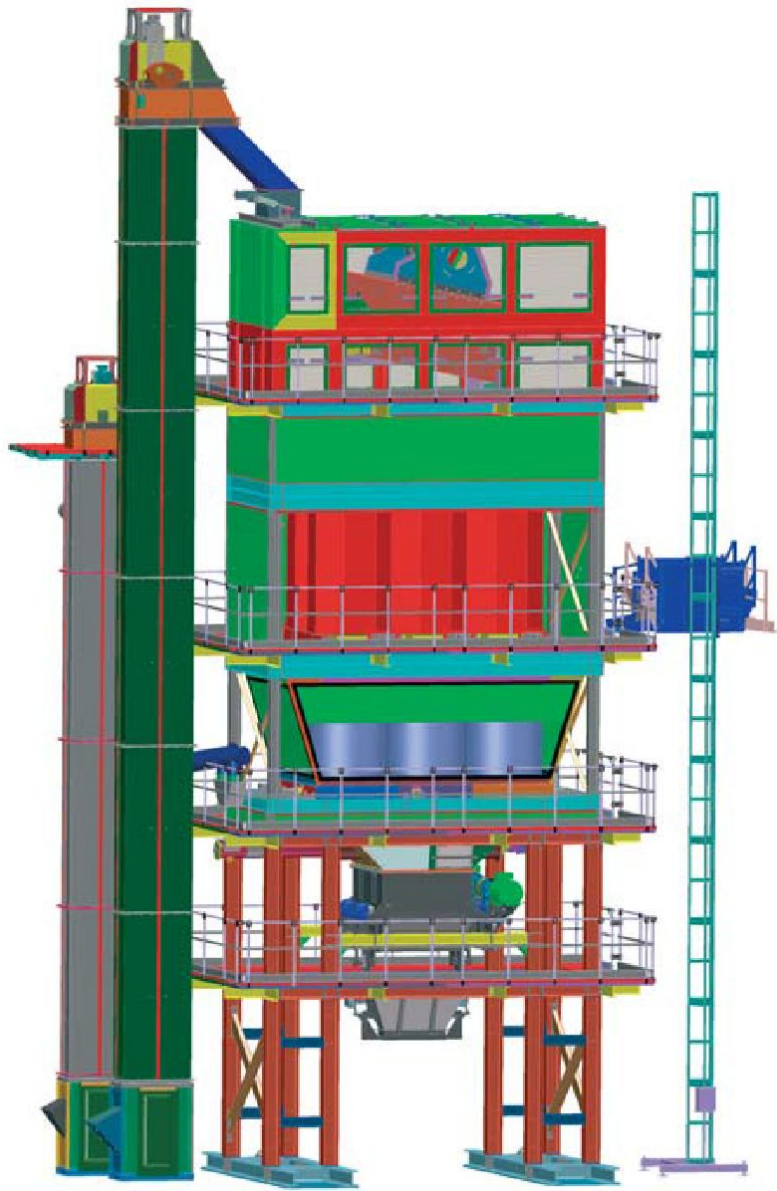

# AMOMATIC





# ТЕХНОЛОГИЯ УПРАВЛЕНИЯ СКОРОСТЬЮ ВРАЩЕНИЯ СУШИЛЬНОГО БАРАБАНА АМОМАТИС



# MEEKER





# ТЕПЛОВАЯ ИЗОЛЯЦИЯ СУШИЛЬНОГО БАРАБАНА МЕЕКЕР

Before



After

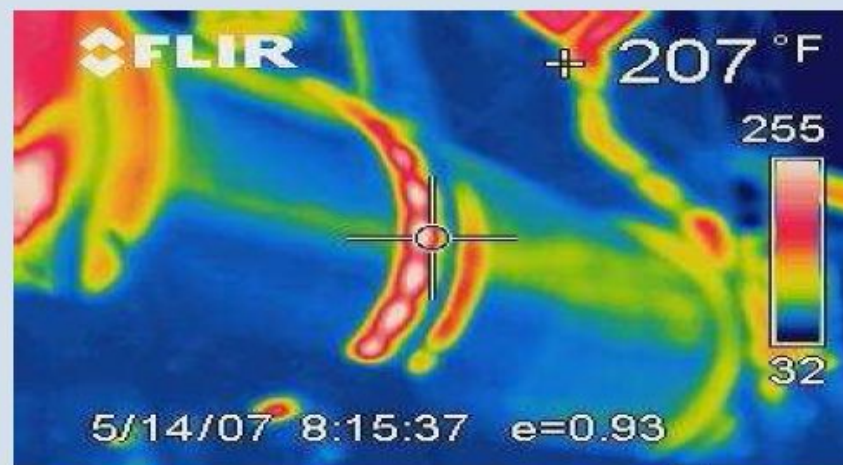

# ЛЕНТОЧНЫЙ ТРАНСПОРТЕР MEEKER





# ASTECC INDUSTRIES, INC



АГРЕГАТ ПИТАНИЯ ASTEC INC

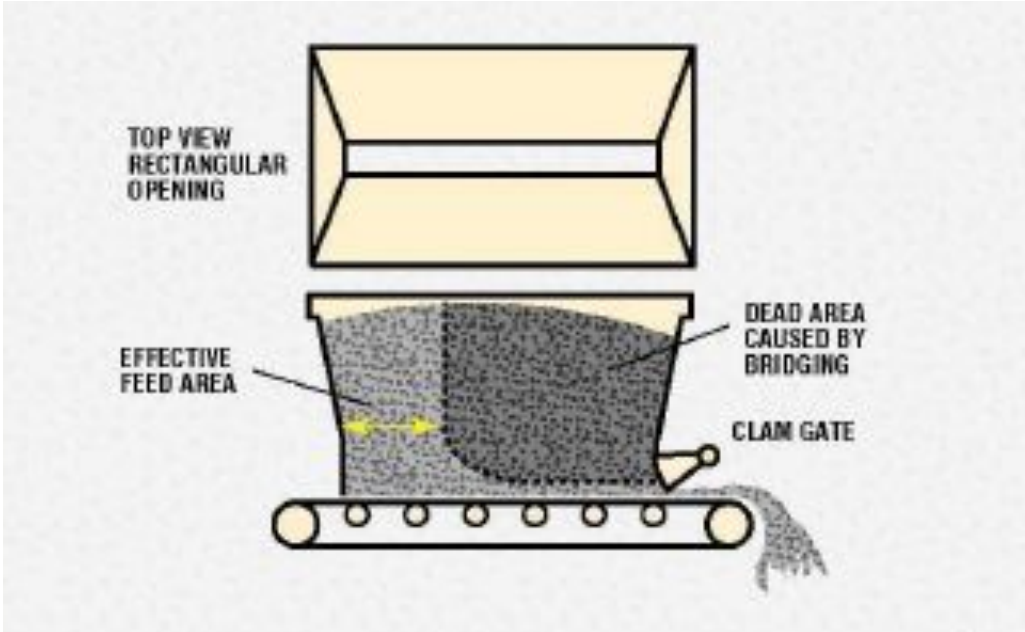

Вид сверху на саморазгружающееся отверстие

Эффективная зона питания

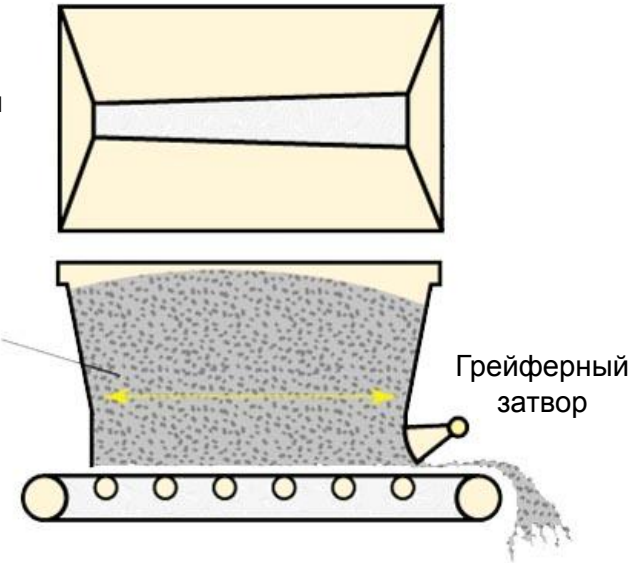



# ТЕХНОЛОГИЯ ДВОЙНОЙ БАРАБАН ASTEC INC

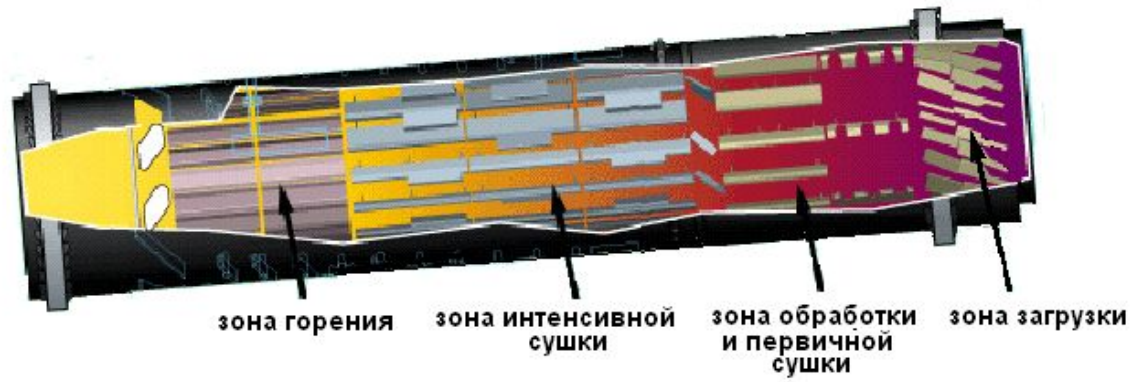
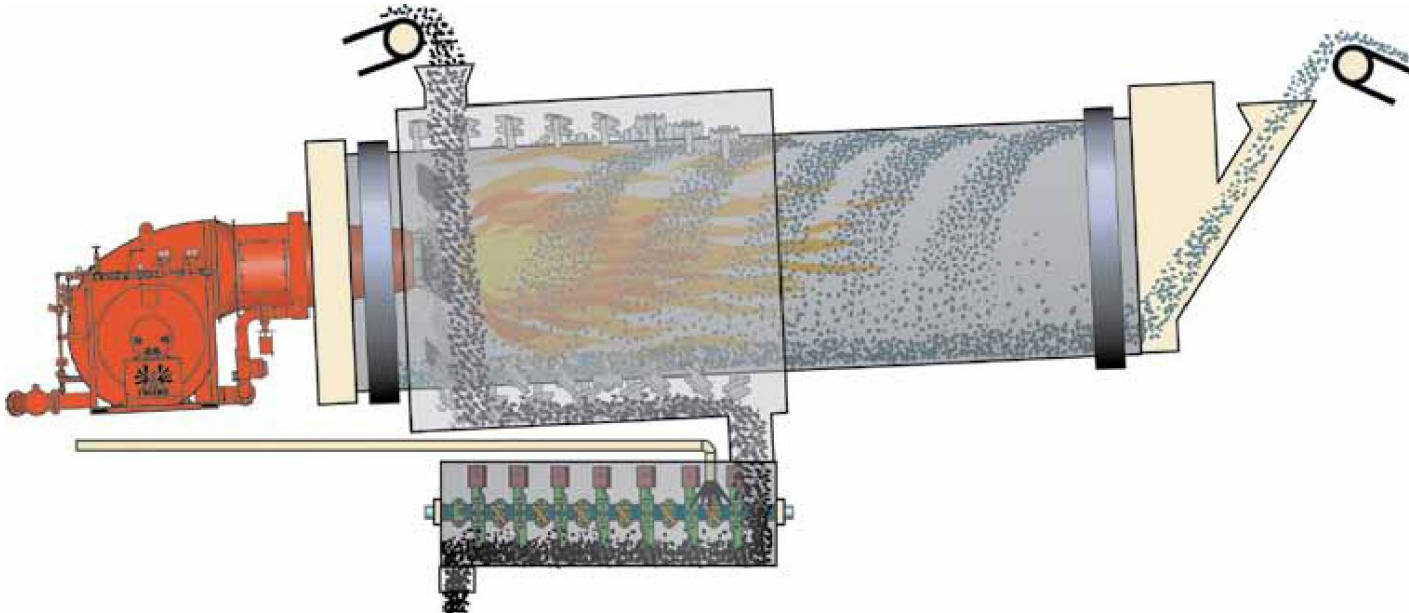

# ВНУТРЕННИЙ БАРАБАН ASTEC INC

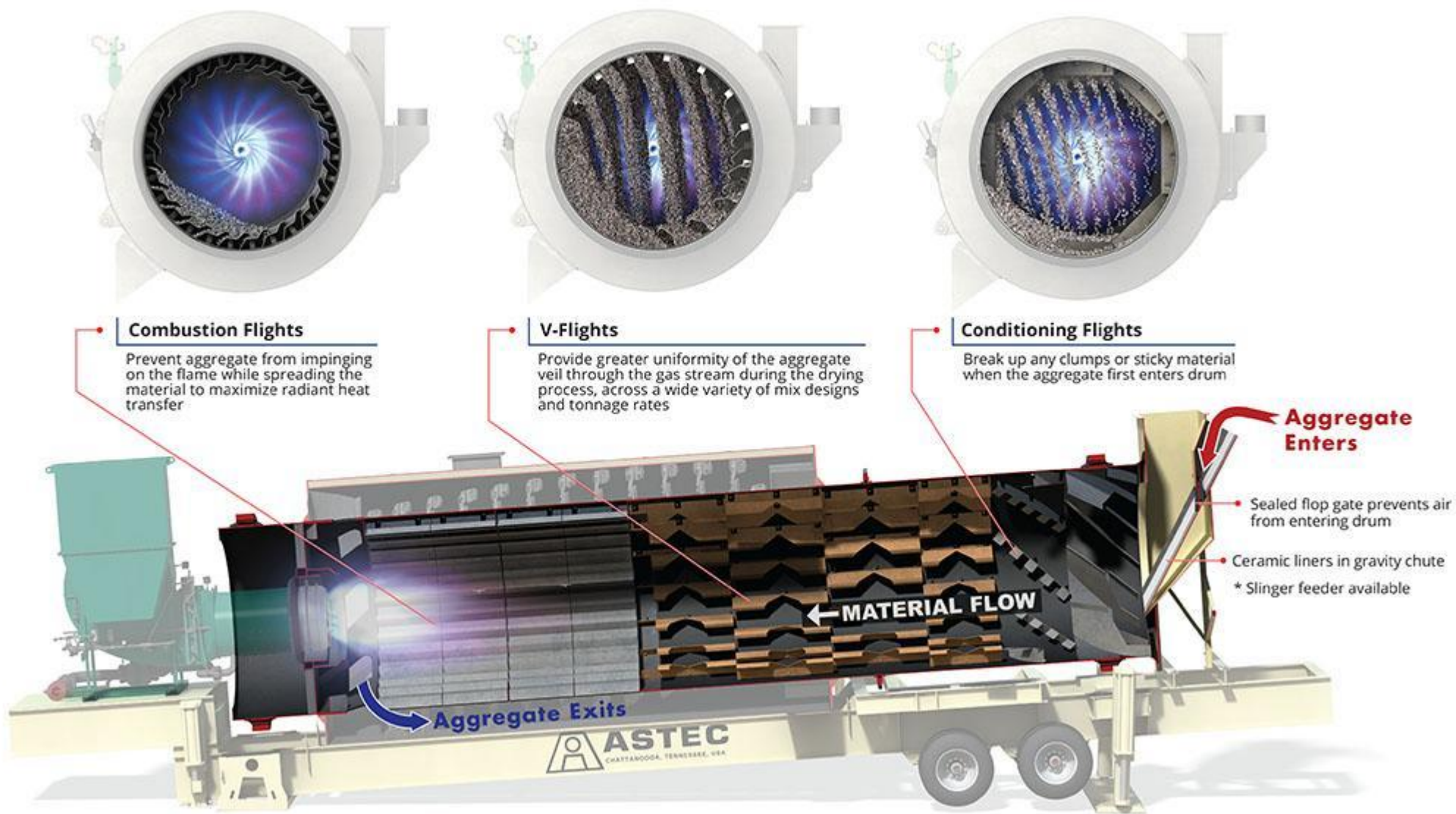



# ВНЕШНИЙ БАРАБАН ASTEC INC



## RAP (Recycled Asphalt Pavement)

RAP material is added to the aggregate in the mixing chamber



## Liquid Asphalt

Liquid asphalt is injected into the mixing chamber through the AC inlet or optional Warm Mix System

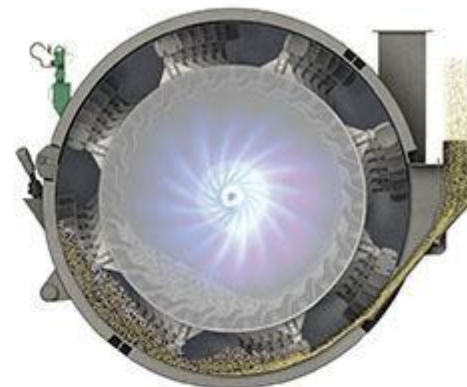

## Fine Additives

Baghouse fines are added last so they do not absorb the liquid AC before it is distributed on the aggregate

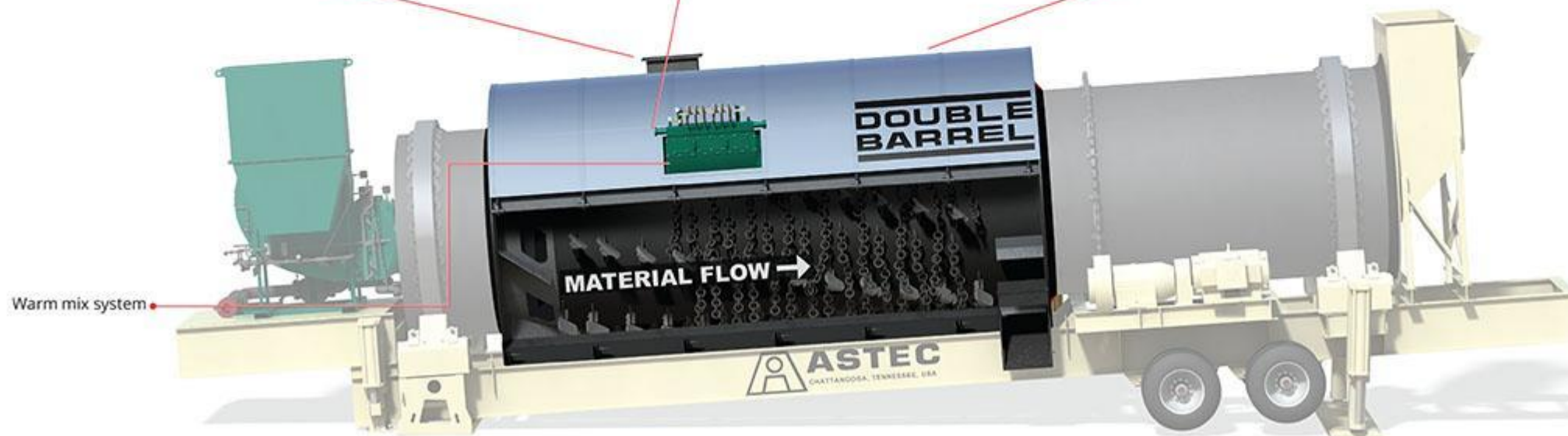

# ВНЕШНИЙ БАРАБАН ASTEC INC

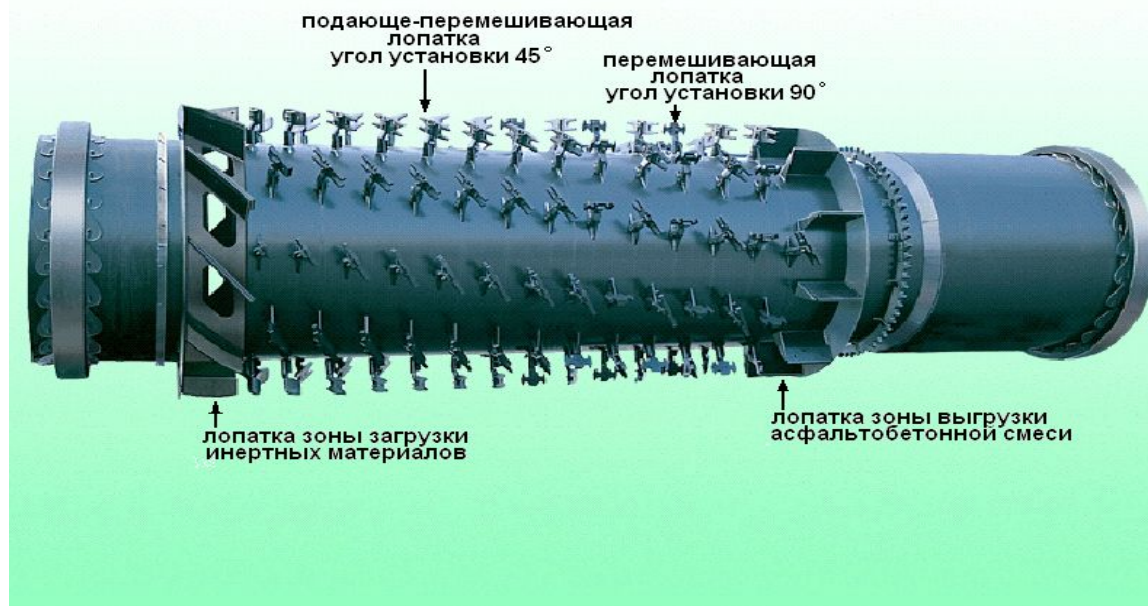



# ПОТОК ВОЗДУХА И ПАРОВ ASTEC INC

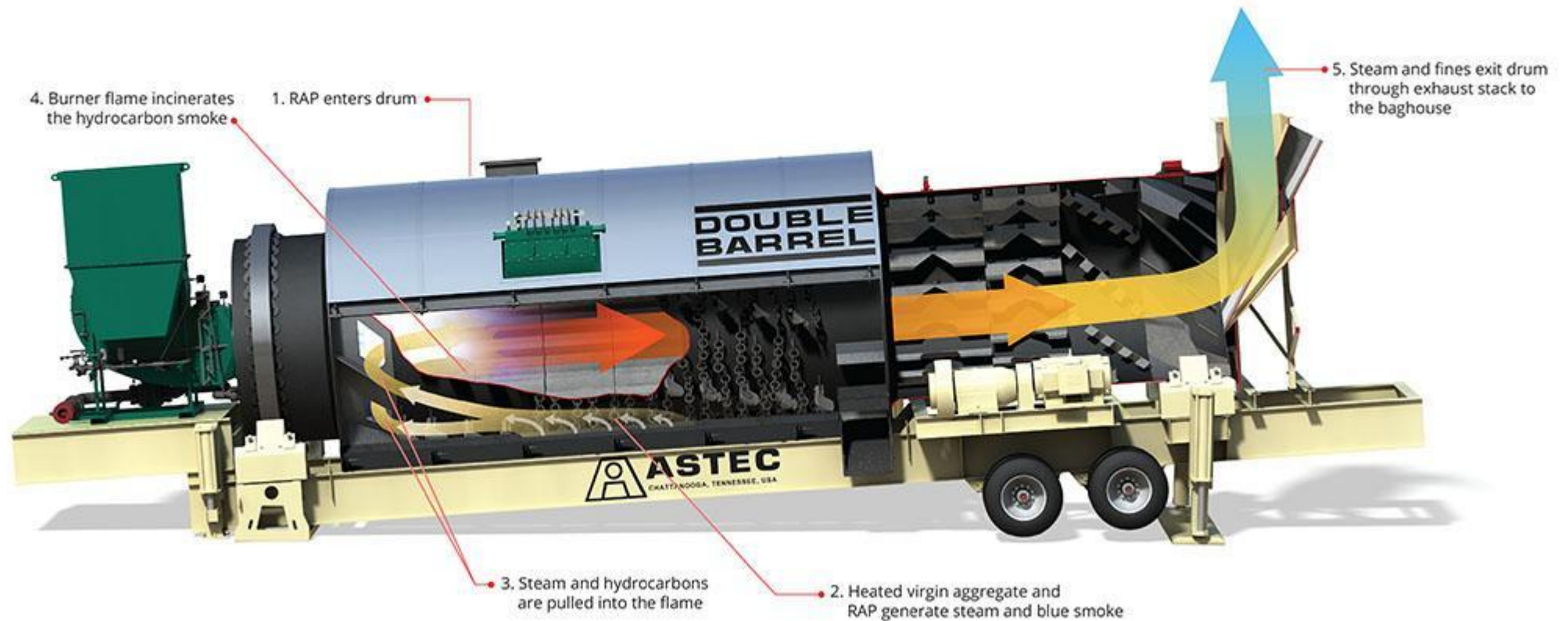

**The Cleaning Process**

- ➔ Dirty Air
- ➔ Clean Air

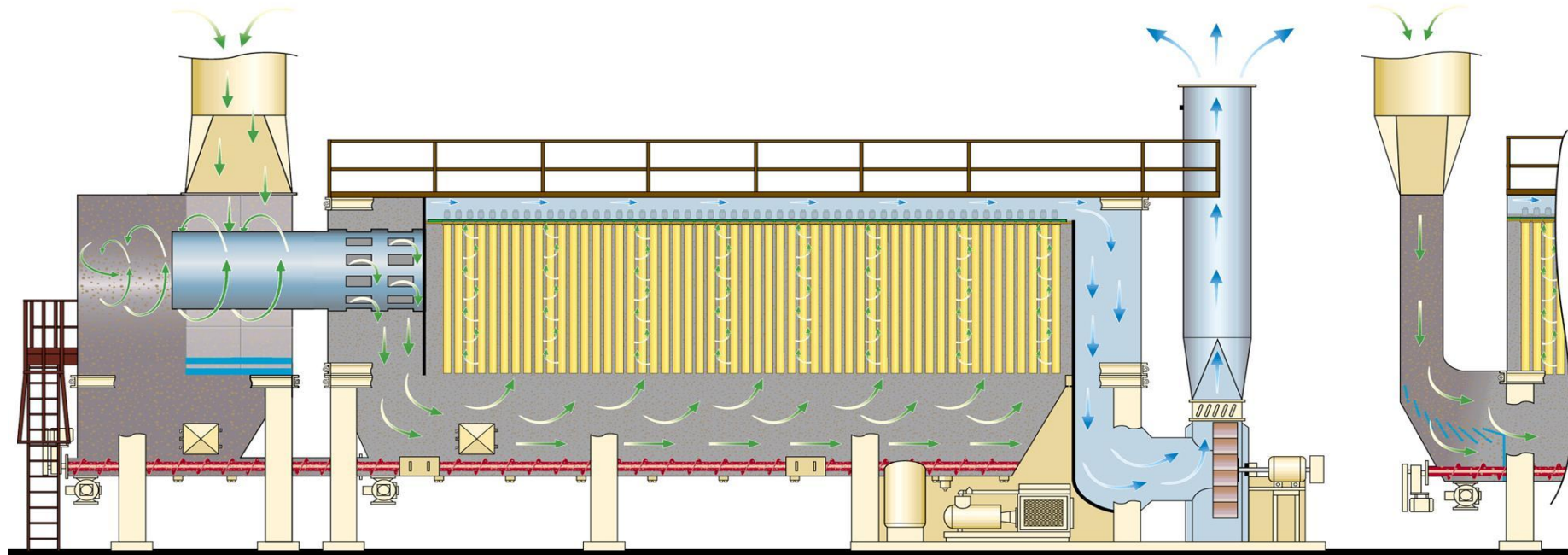

**AIR FLOW**

