

# Клеточные контакты

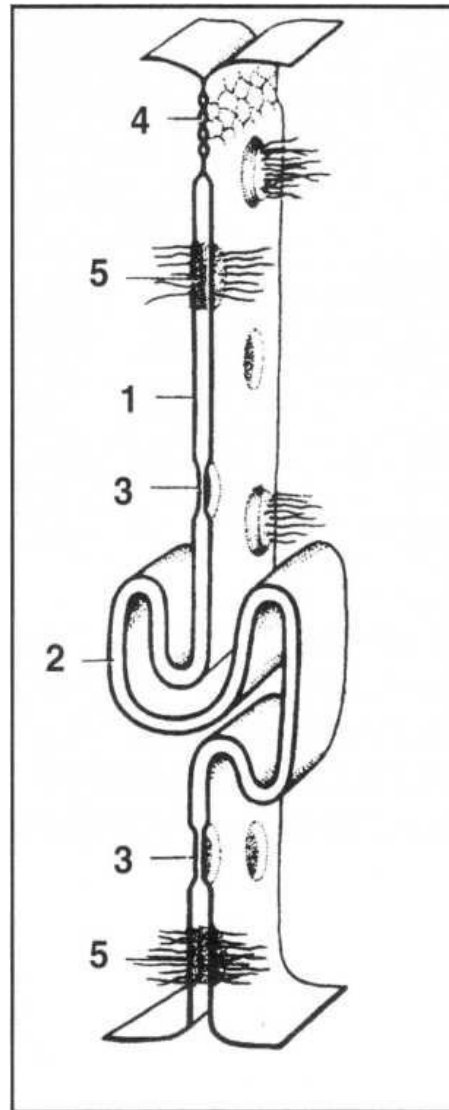

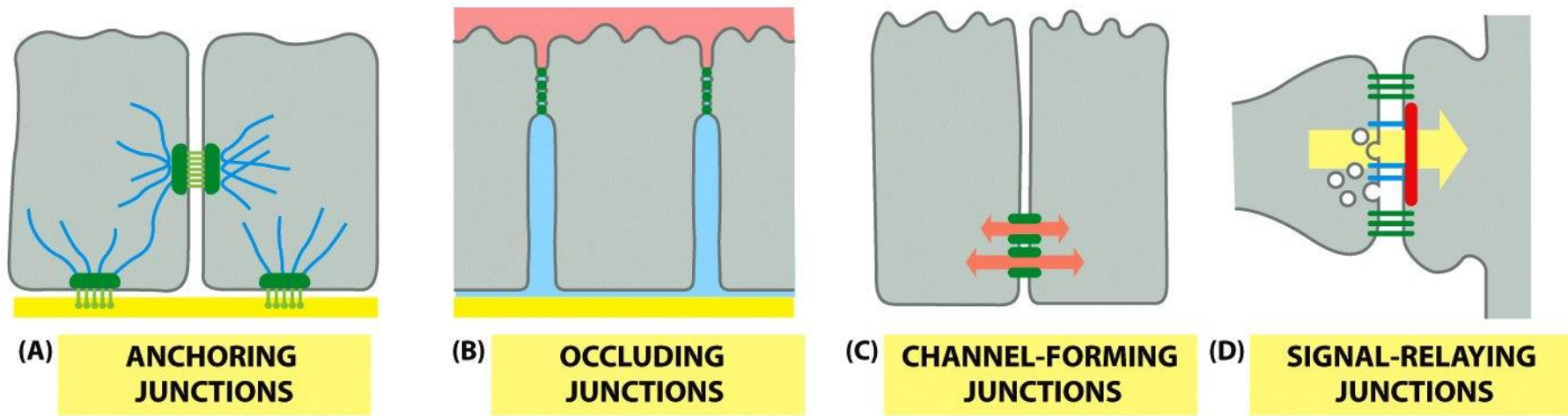
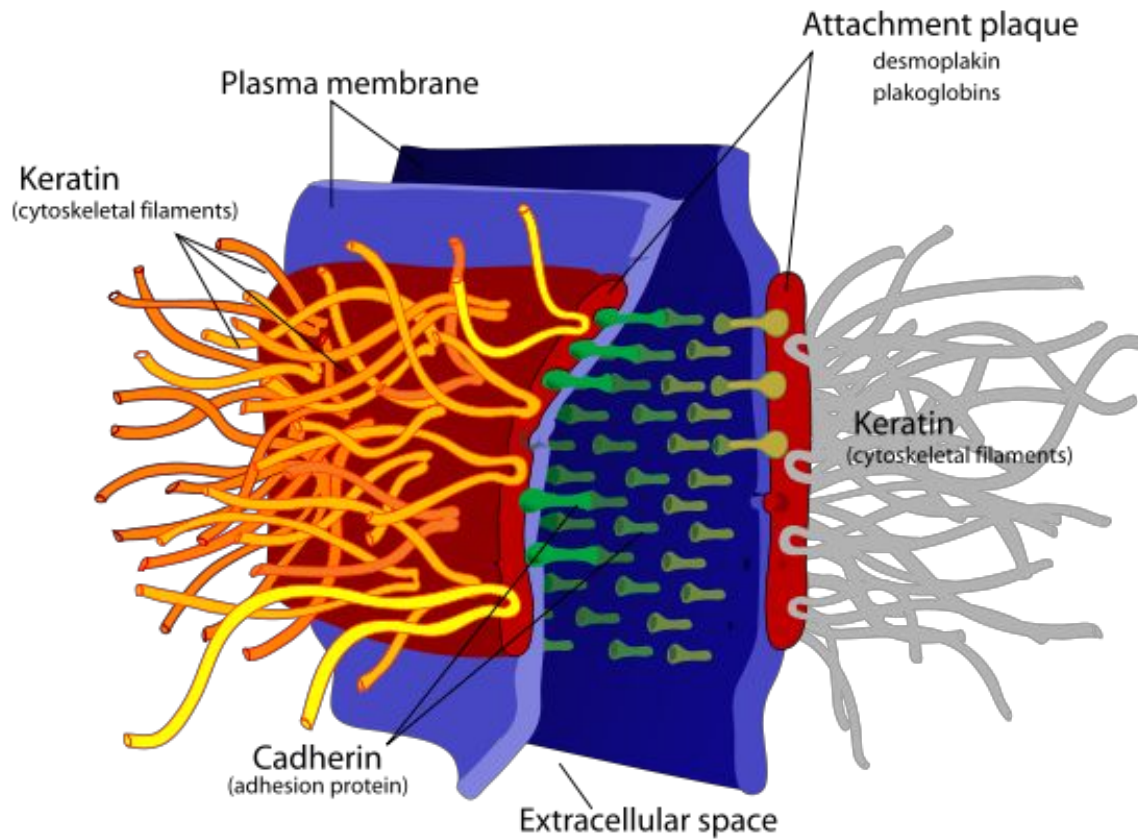
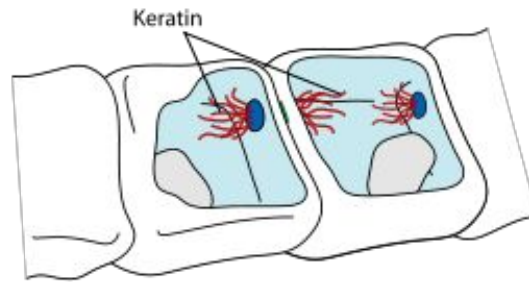

Figure 19-2 *Molecular Biology of the Cell* (© Garland Science 2008)

# Десмосомы



# Плотный контакт (запирающая

связь)

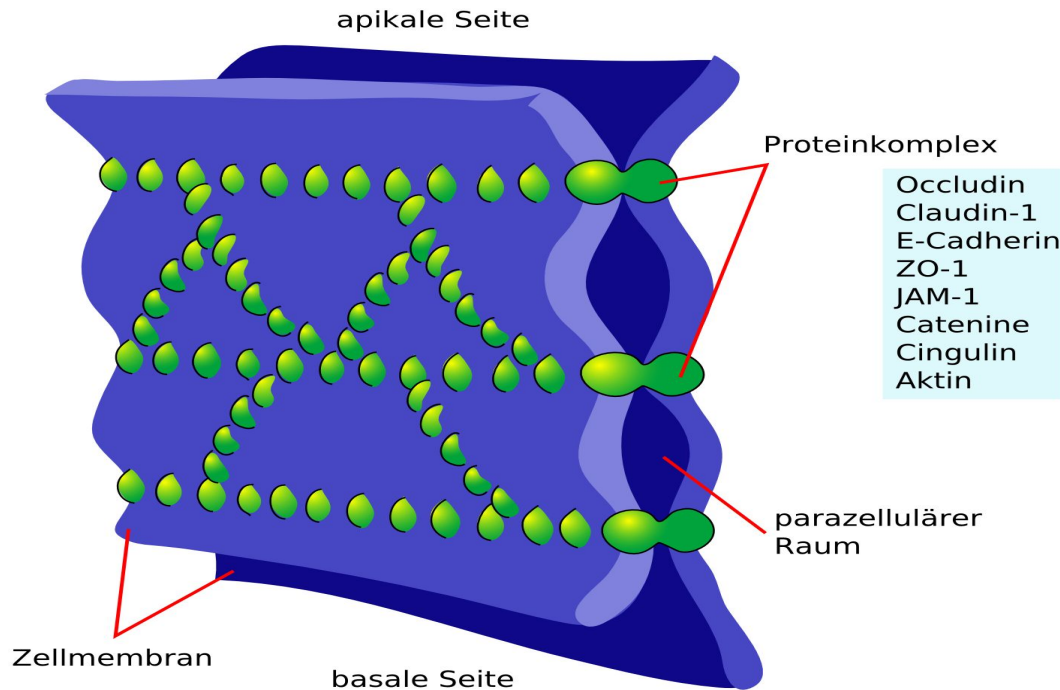
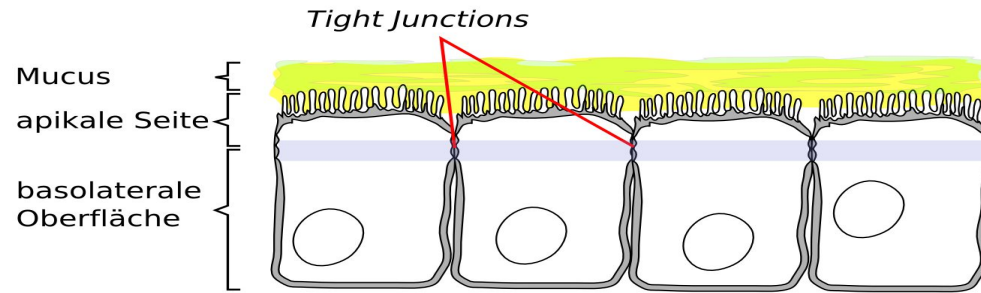

# Плазмодесмы

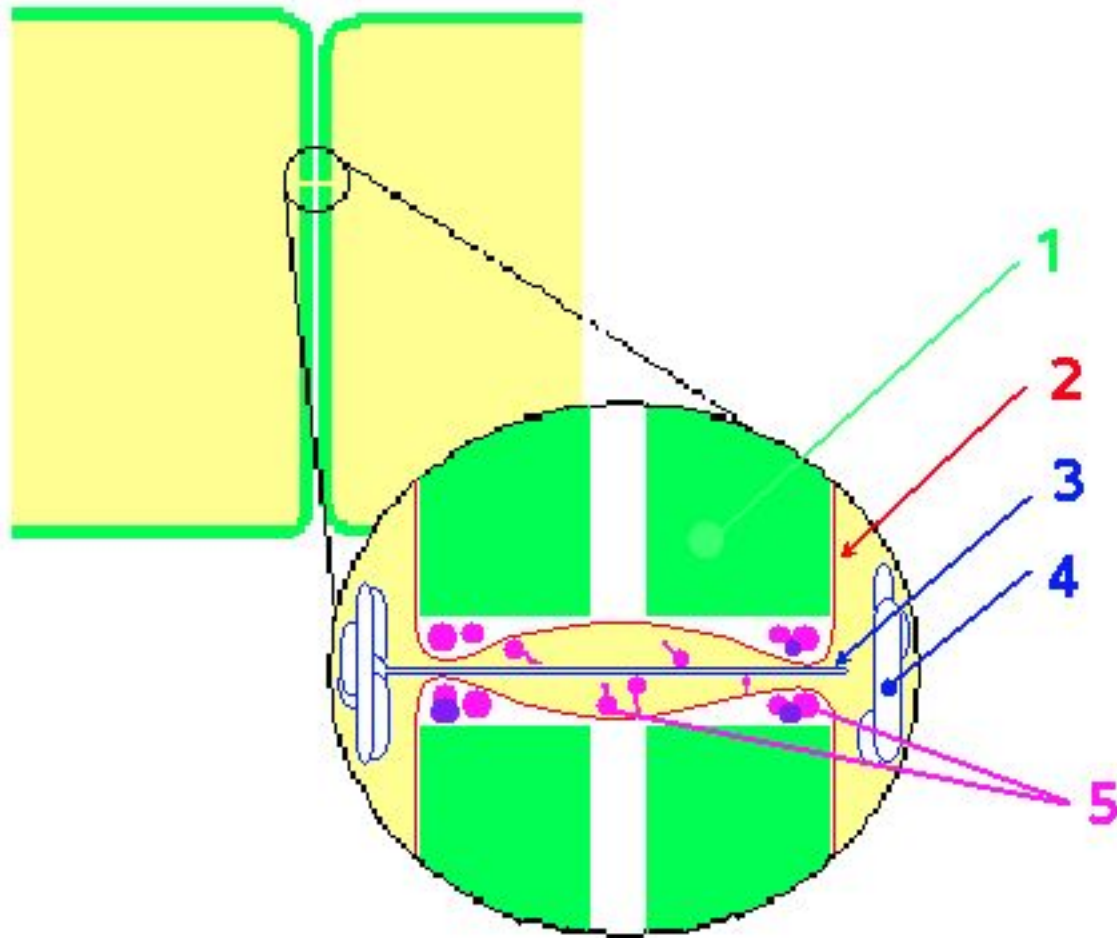

# Щелевые контакты (нексус)

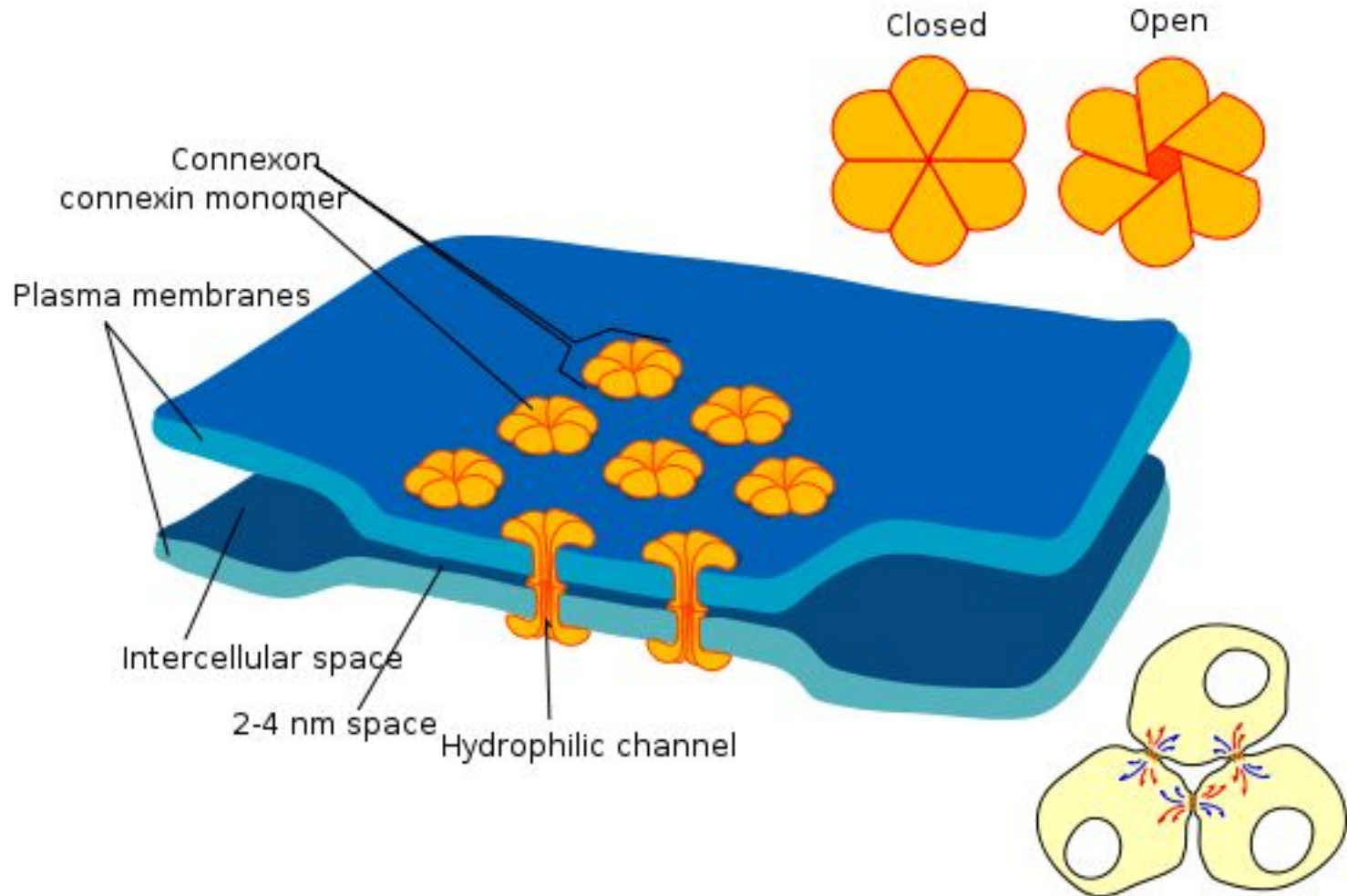

# Синапс

