

Решение задач по теме:

«Подобие треугольников.»

4

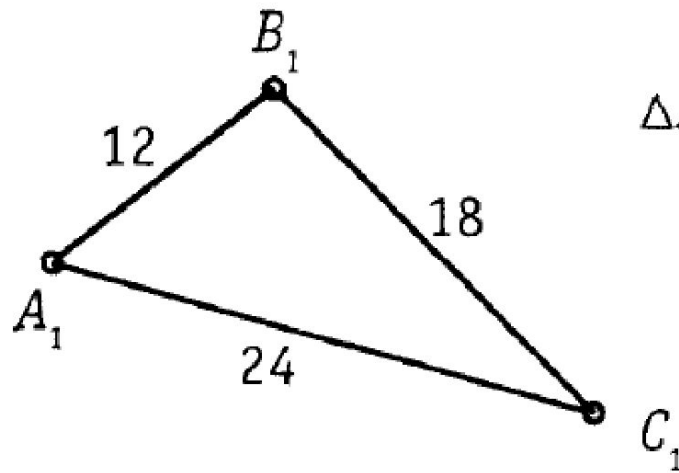
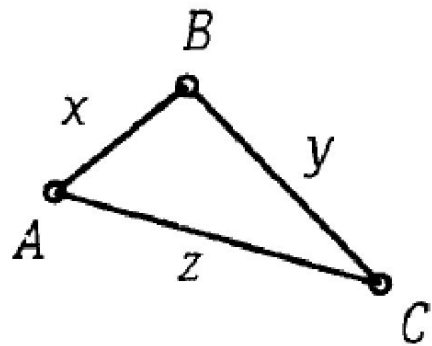

$$\triangle ABC \sim \triangle A_1B_1C_1$$

$$P_{\triangle ABC} = 36$$

9

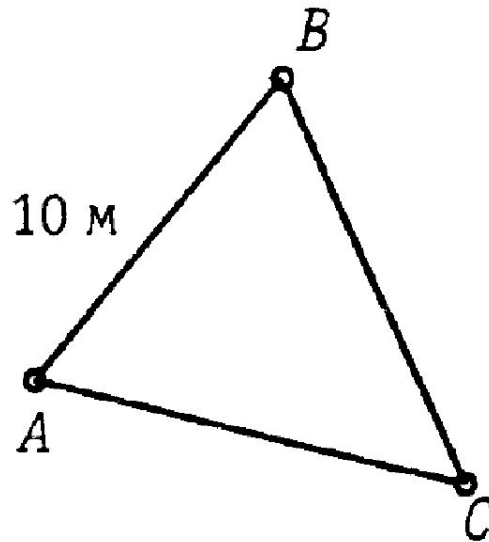
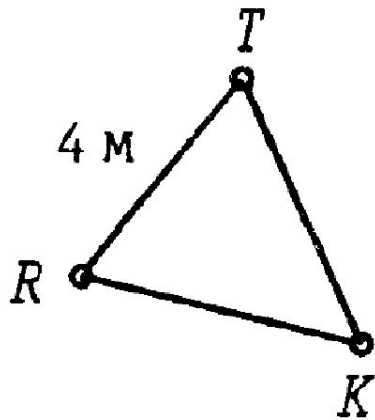

$$\triangle RTK \sim \triangle ABC$$

$$S_{\triangle RTK} = 16\text{ M}^2$$

$$S_{\triangle ABC} = x$$

17

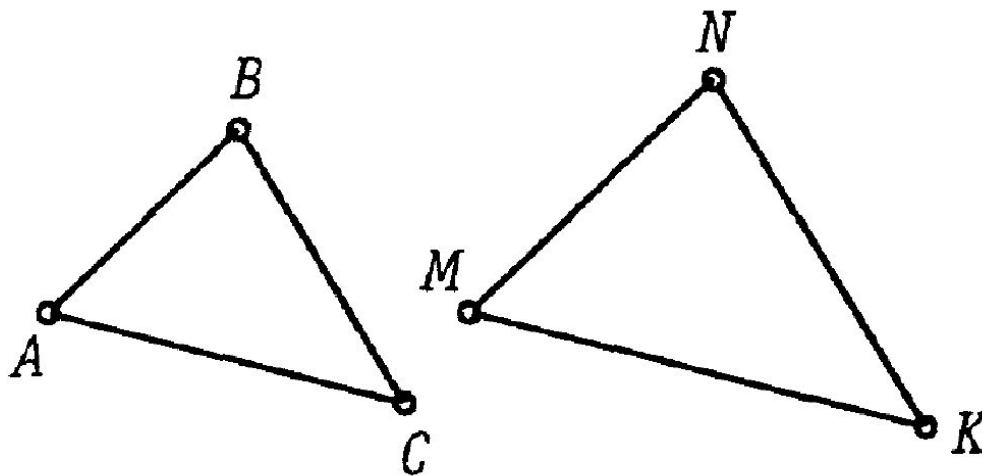

$$\triangle ABC \sim \triangle MNK$$

$$P_{\triangle ABC} : P_{\triangle MNK} = 2 : 3$$

$$S_{\triangle ABC} + S_{\triangle MNK} = 130 \text{ m}^2$$

$$S_{\triangle ABC} = x$$

$$S_{\triangle MNK} = y$$

Найти x, y

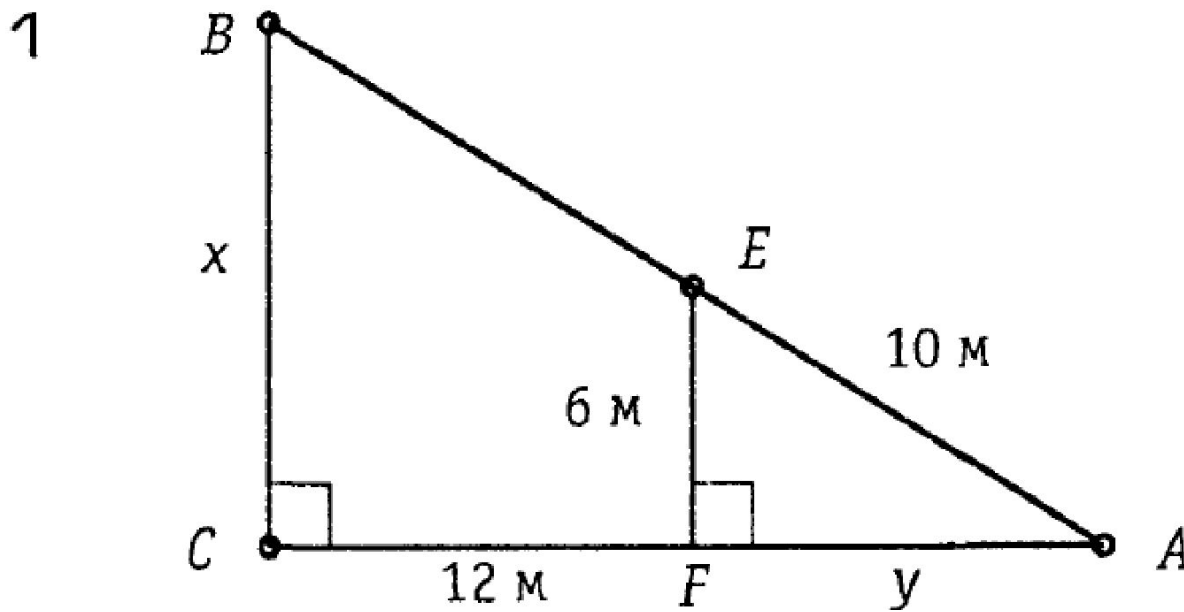

2

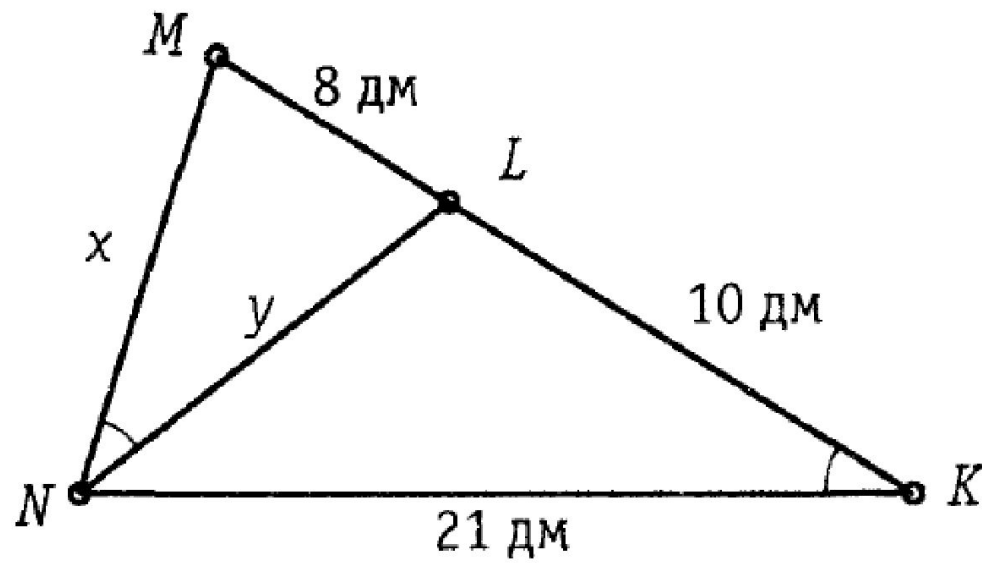

3

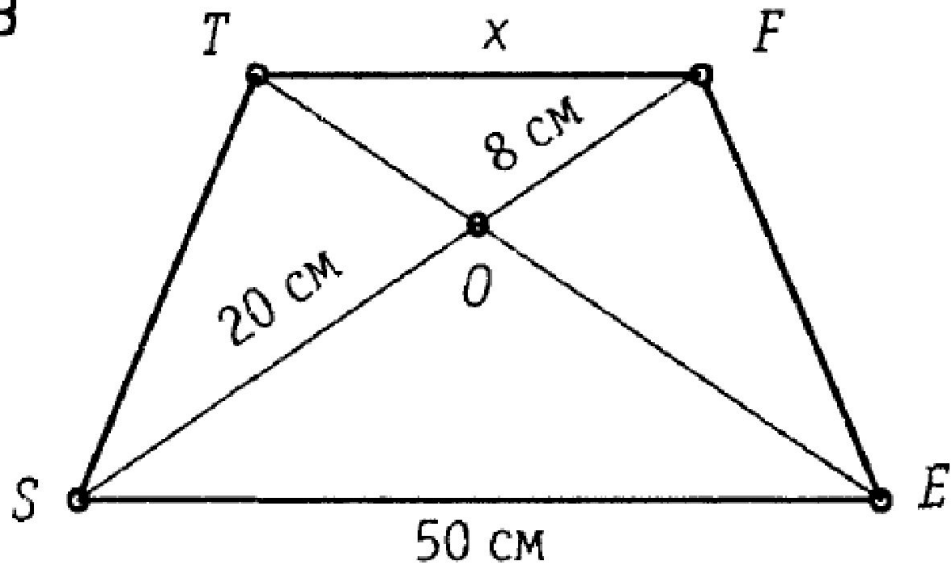

4

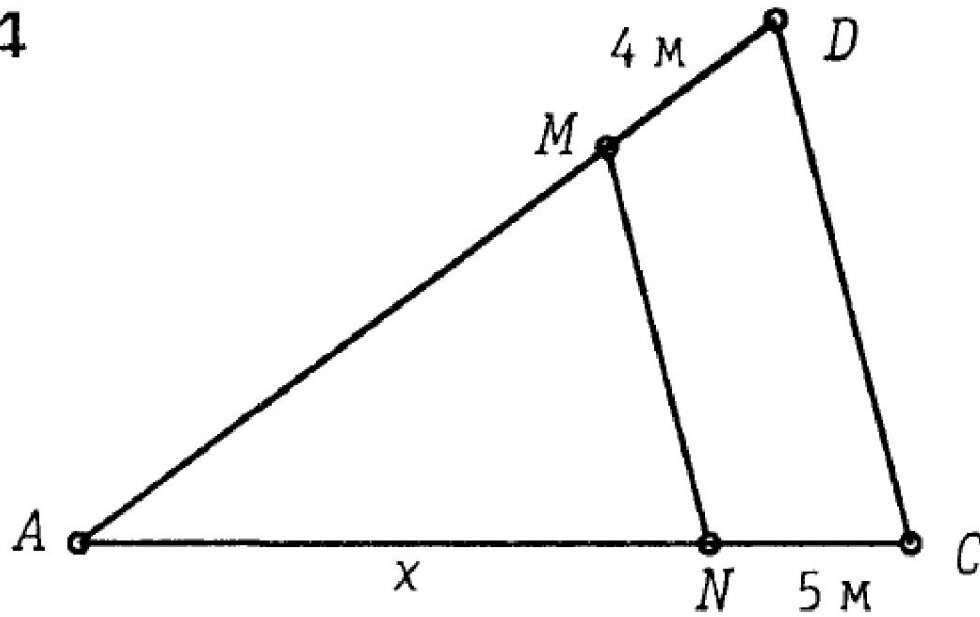

$DC \parallel MN$
 $AD = 11\text{ m}$

21

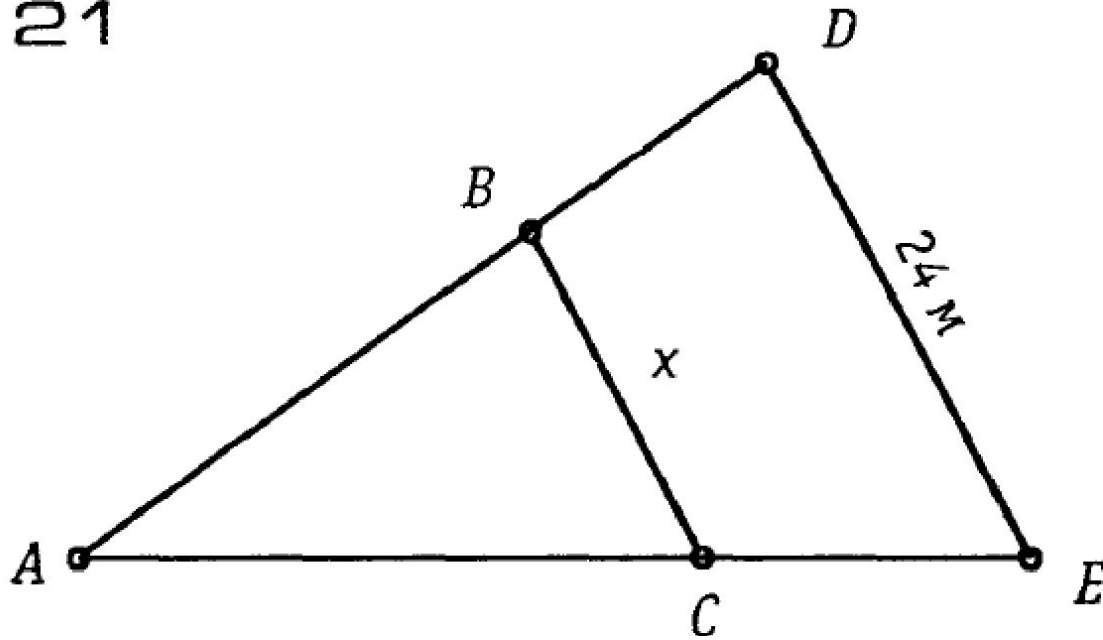

$BC \parallel DE$
 $AB : BD = 2 : 1$

28

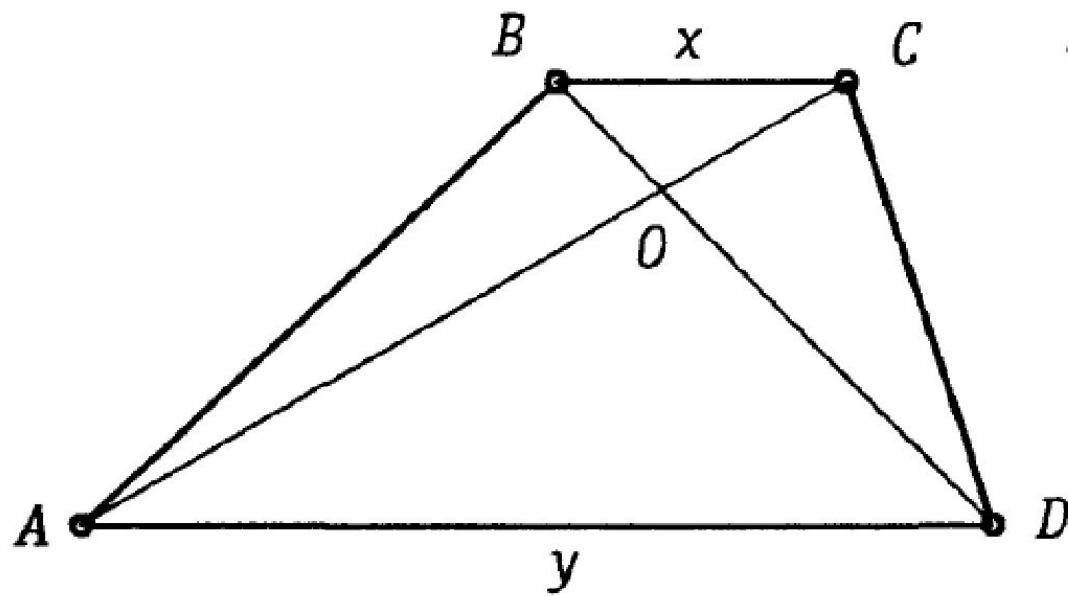

$$S_{\triangle BOC} : S_{\triangle AOD} = 1 : 9$$

$$x + y = 9,6 \text{ дм}$$

$$BC \parallel AD$$

Домашняя работа:

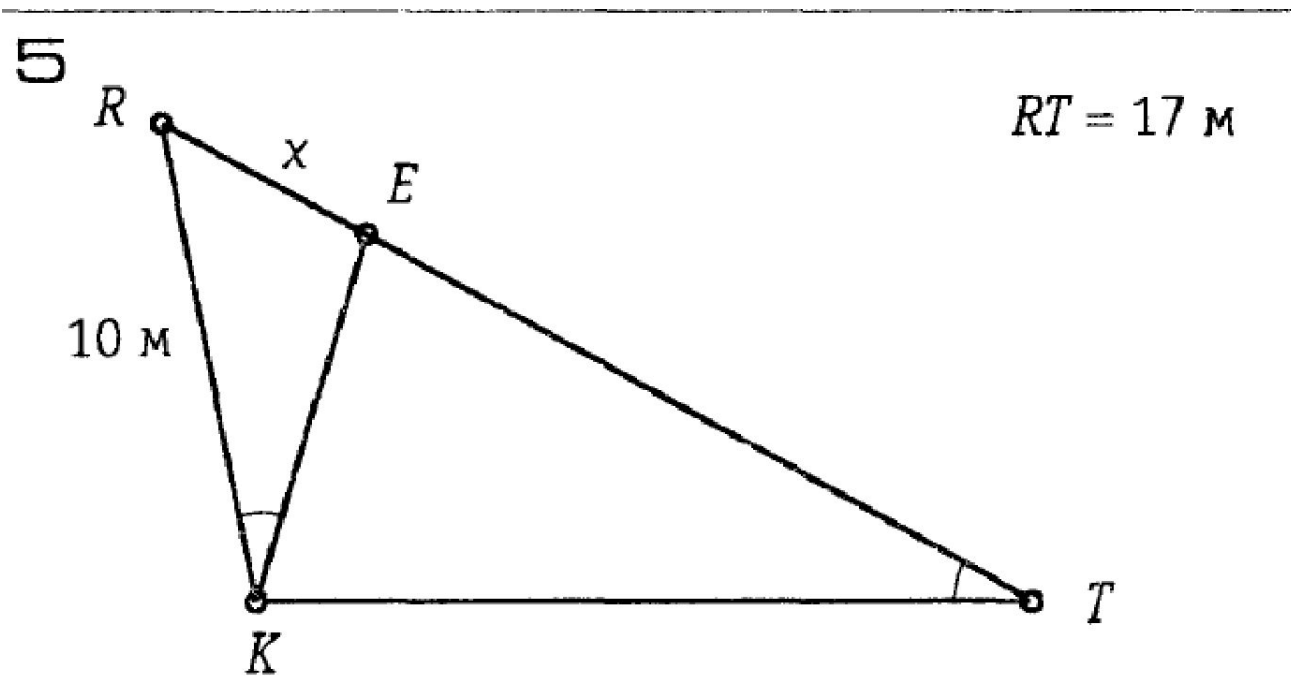

6

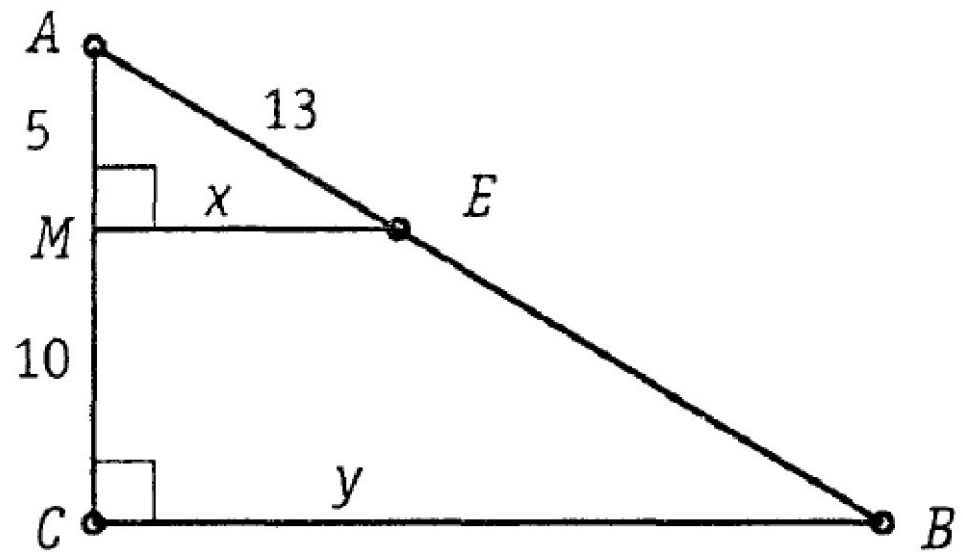

8

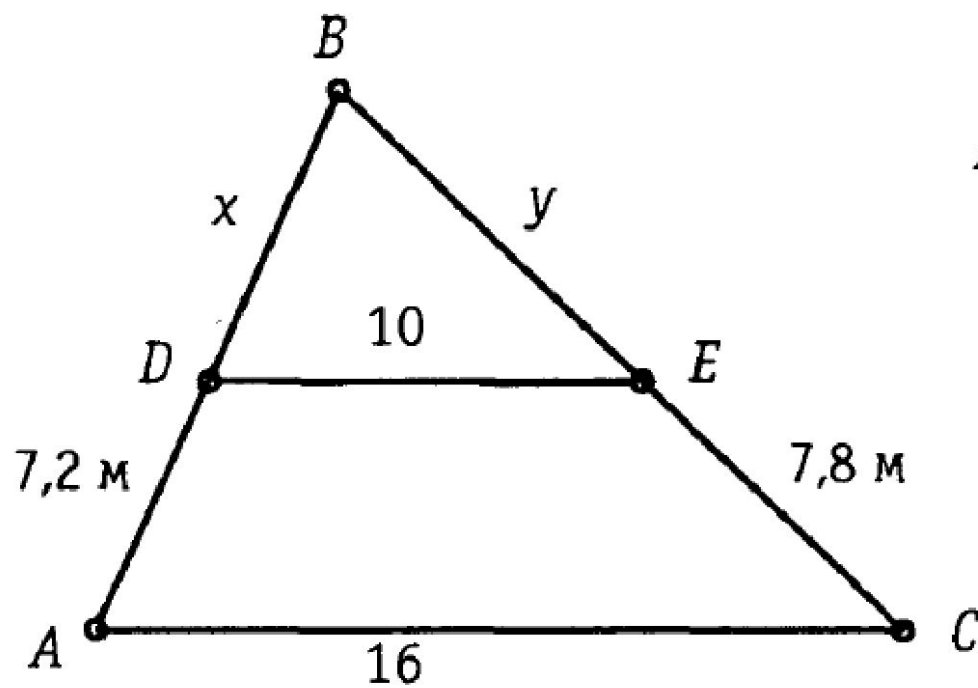

$DE \parallel AC$

16

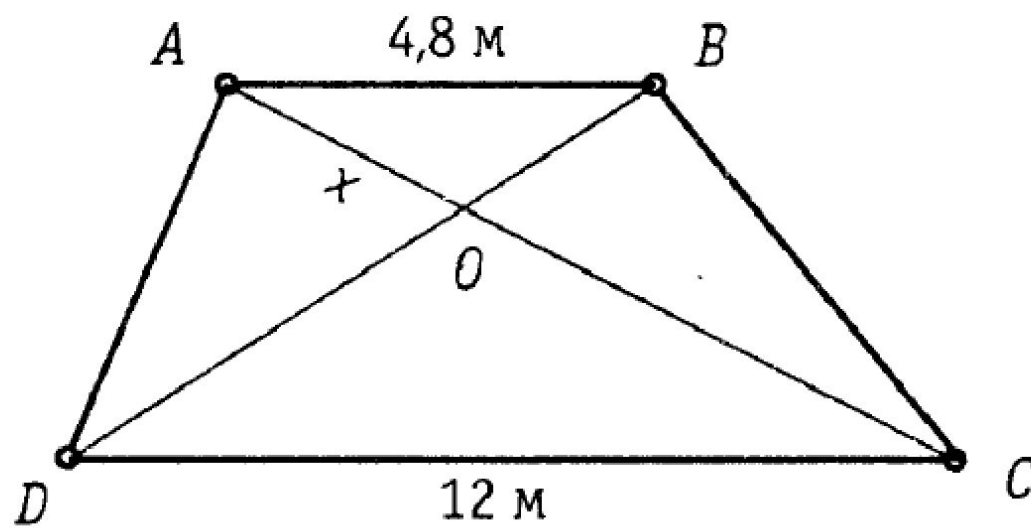

$AB \parallel DC$
 $AC = 7,5 \text{ m}$