

Чертеж случайно залили тушью. Не сможете ли вы по оставшимся линиям, числам и знакам его восстановить?

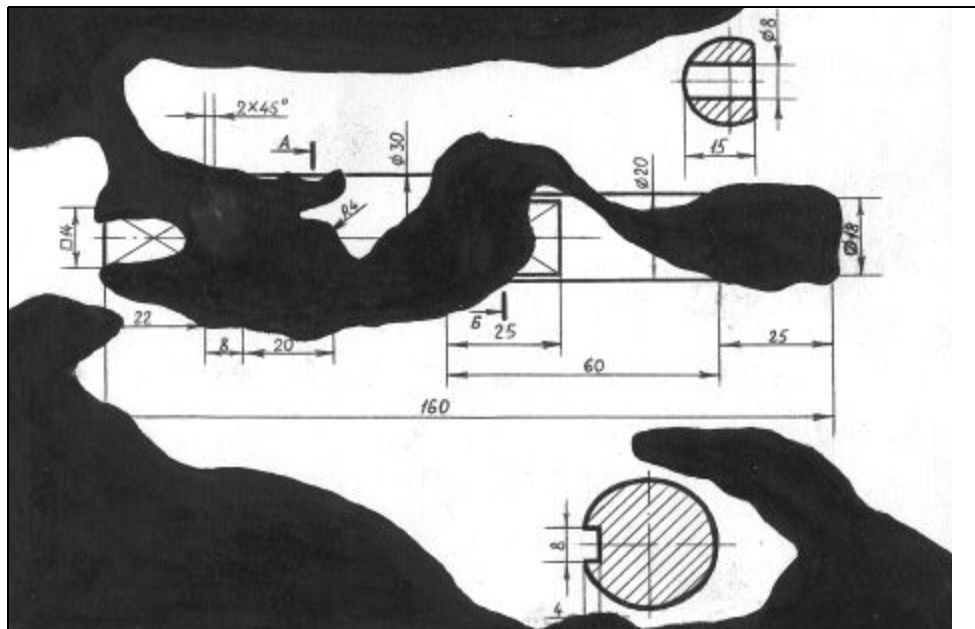

Выполнить чертеж с исправлением допущенных на нем ошибок

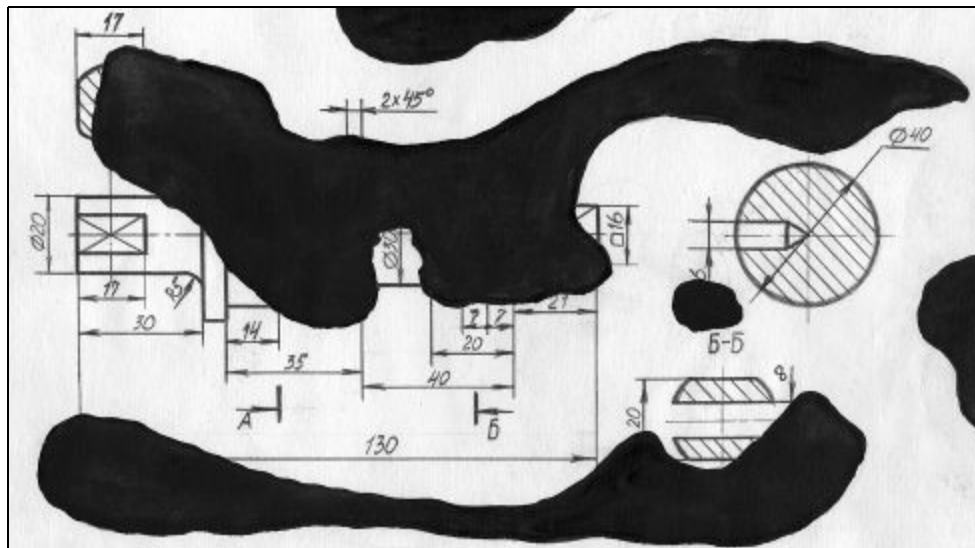
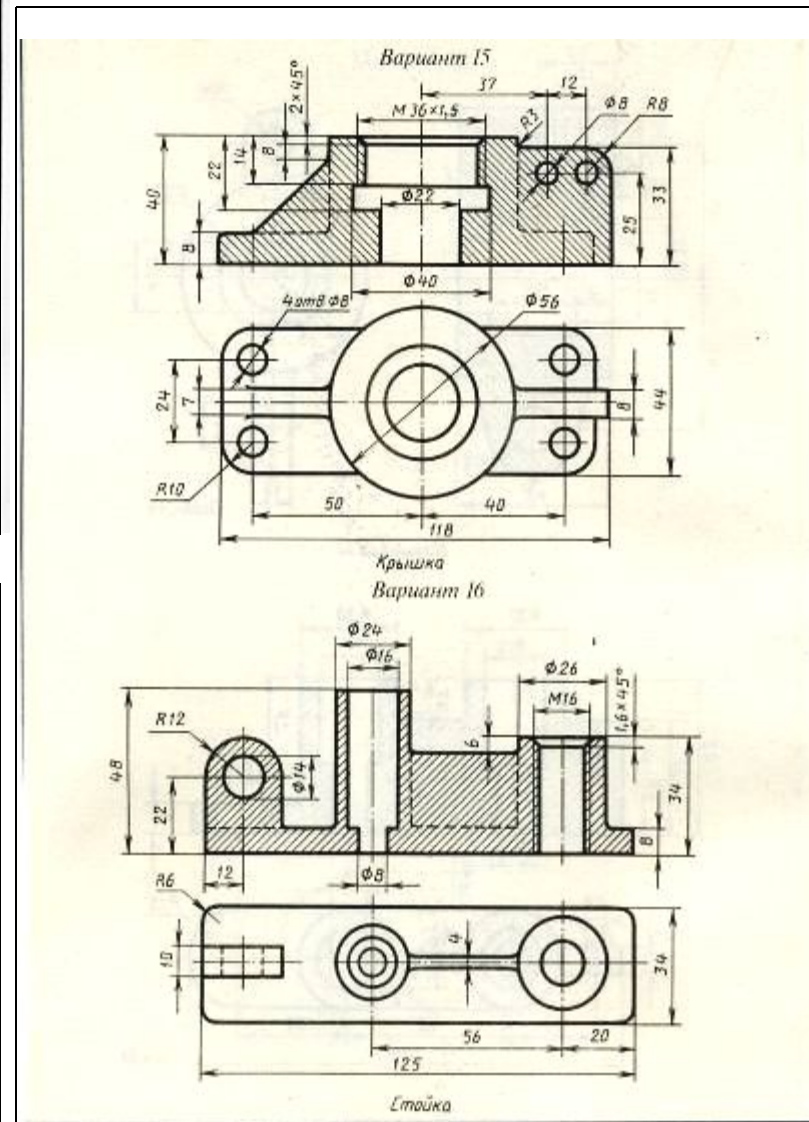

Задачи – головоломки

По двум заданным видам предмета построить третий вид

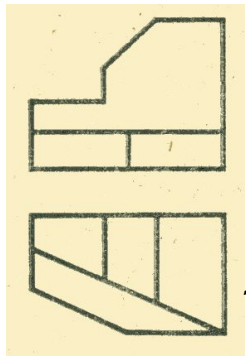

1

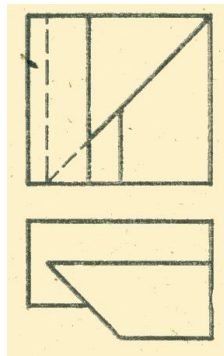

2

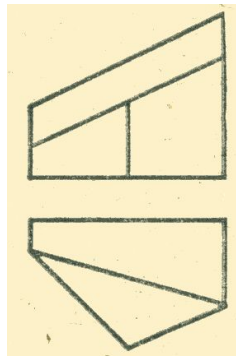

3

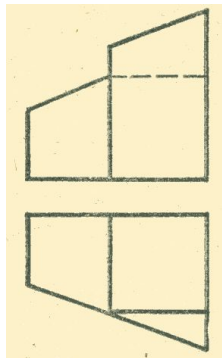

4

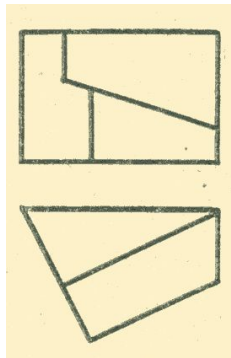

5

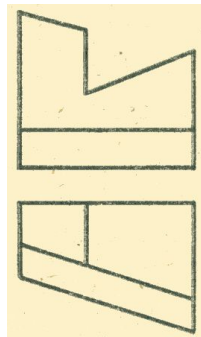

6

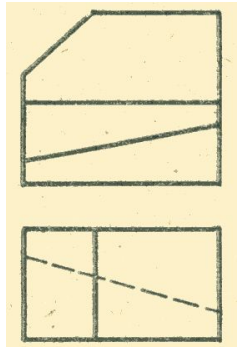

7

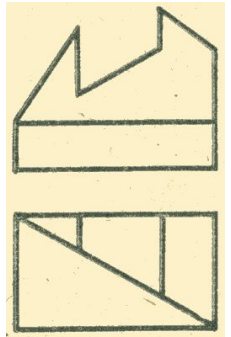

8

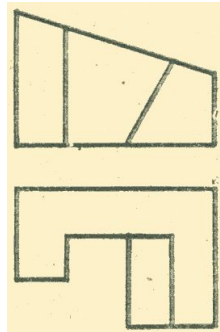

9

Определите, какому из геометрических тел принадлежит каждое сечение.

