

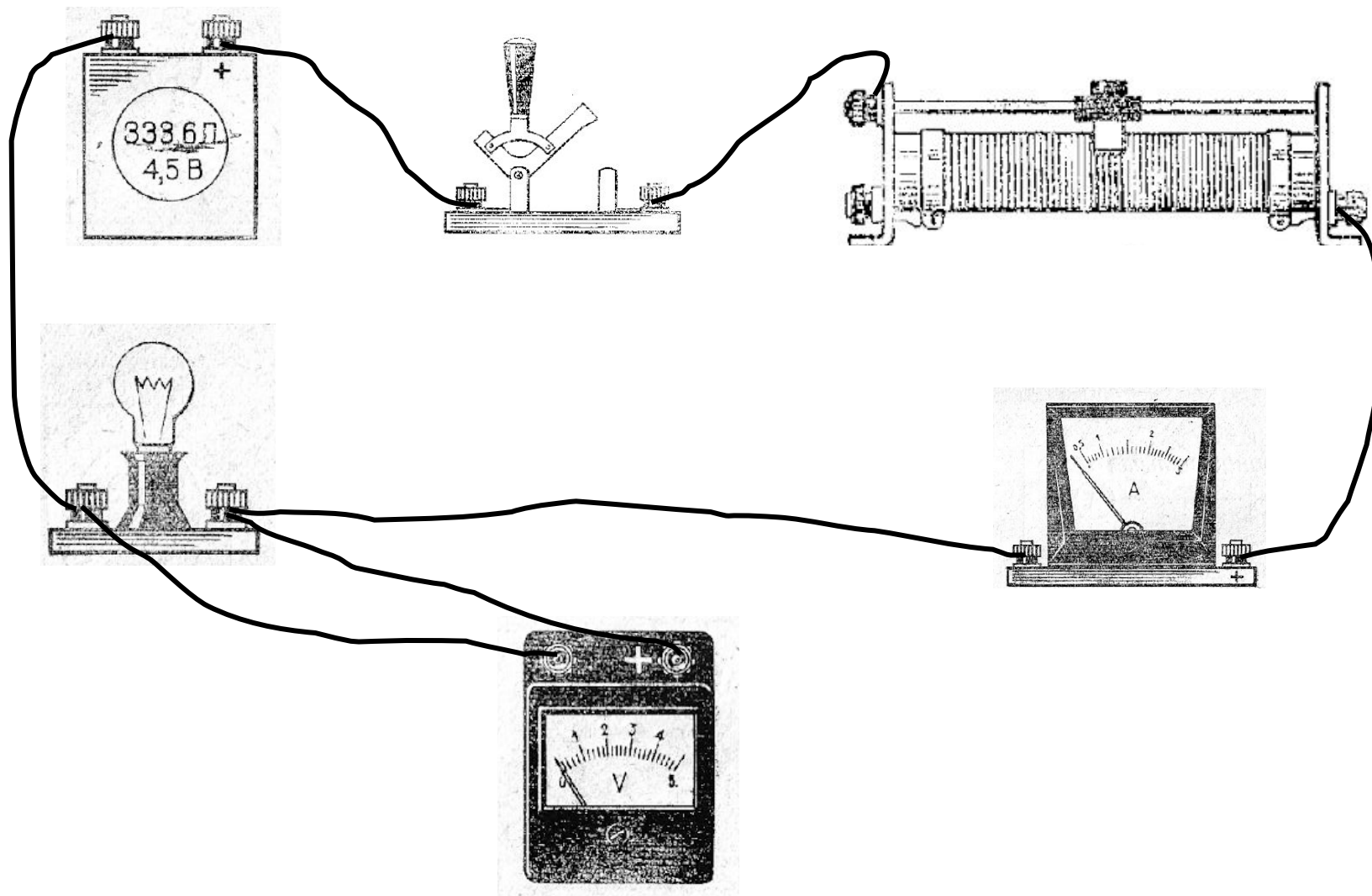





ЭЛЕКТРИЧЕСКАЯ ЦЕПЬ И ЕЕ СОСТАВНЫЕ ЧАСТИ



ЭЛЕКТРИЧЕСКАЯ ЦЕПЬ

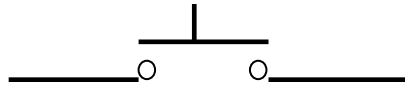
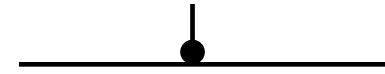
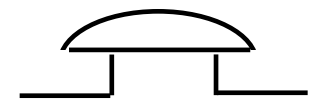
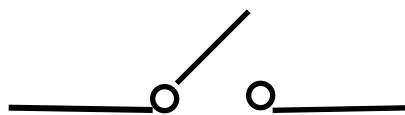

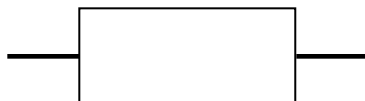
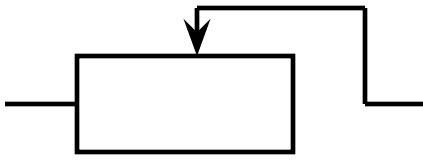
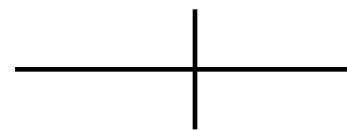
Условное обозначение элементов электрической цепи

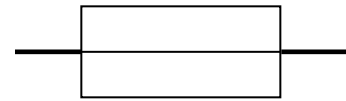
источники тока	потребители	управляющие элементы	провода
 <p>гальванический элемент</p>	 <p>лампочка</p>	 <p>кнопка</p>	 <p>соединение проводов</p>
	 <p>звонок</p>	 <p>ключ</p>	 <p>клеммы</p>
 <p>батарея элементов</p>	 <p>резистор</p>	 <p>реостат</p>	 <p>пересечение проводов</p>
	 <p>нагревательный элемент</p>	 <p>предохранитель</p>	

ЭЛЕМЕНТЫ ЭЛЕКТРИЧЕСКИХ СХЕМ

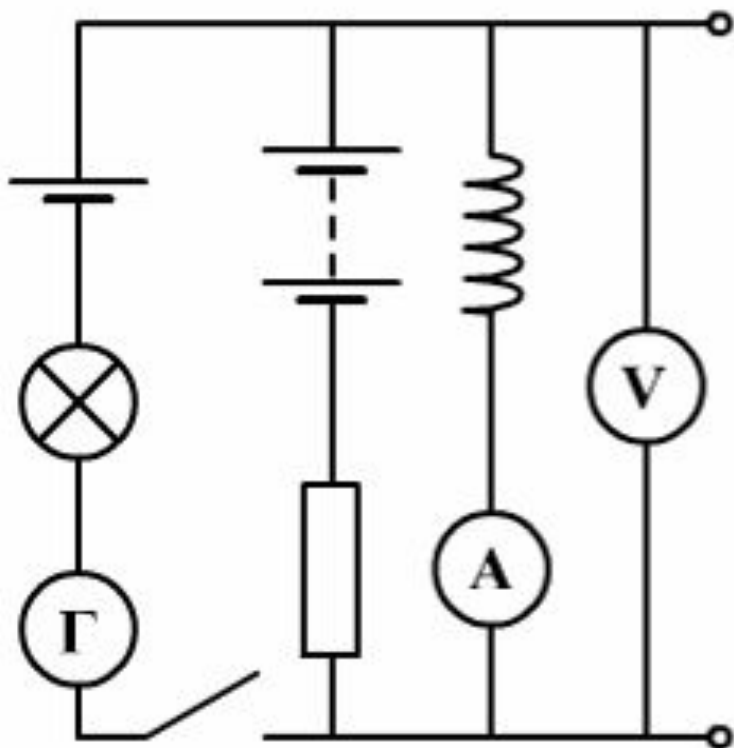

Лампа



Резистор



Вольтметр



Гальванический элемент



Выключатель



Амперметр



Батарея элементов



Катушка



Генератор

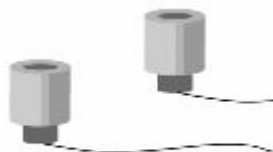

Клеммы