

FLOOR MAP

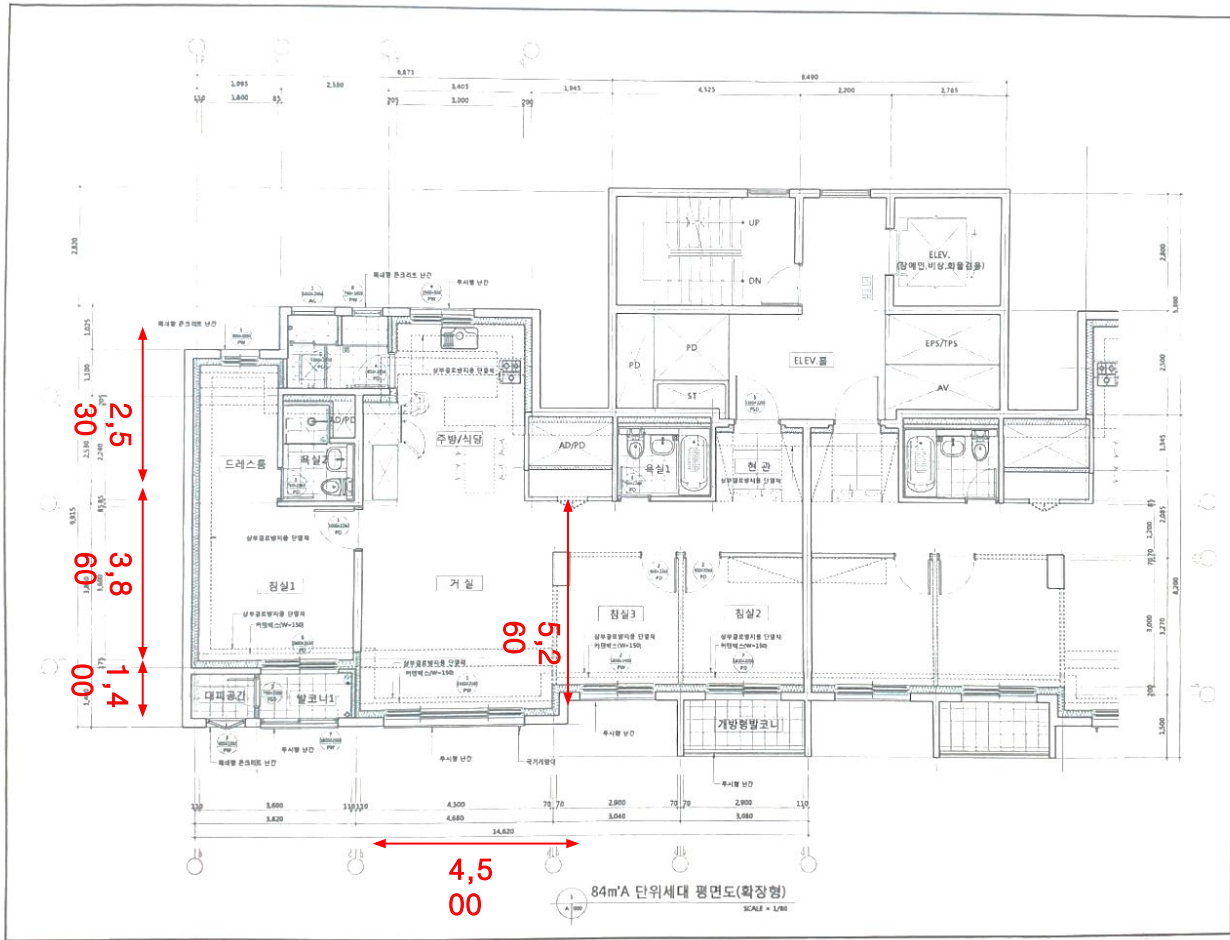

Figure No.
서울 광명 공공주택지구
CI동택 공공주택 신축공사

Figure No.

Notes

1. 가구 배치 세부 계획은 최종 설계안 확정후로, 가구 종류는 2차도면으로 결정한다. 평면 배치 변경을 용이하게 할 수 있도록 하였다.
2. 2차도면으로 결정된 평면 설계는 2차도면 확정후로 변경을 용이하게 할 수 있도록 하였다.
3. 2차도면으로 결정된 평면 설계는 2차도면 확정후로 변경을 용이하게 할 수 있도록 하였다.
4. 2차도면으로 결정된 평면 설계는 2차도면 확정후로 변경을 용이하게 할 수 있도록 하였다.
5. 2차도면으로 결정된 평면 설계는 2차도면 확정후로 변경을 용이하게 할 수 있도록 하였다.
6. 2차도면으로 결정된 평면 설계는 2차도면 확정후로 변경을 용이하게 할 수 있도록 하였다.
7. 2차도면으로 결정된 평면 설계는 2차도면 확정후로 변경을 용이하게 할 수 있도록 하였다.
8. 2차도면으로 결정된 평면 설계는 2차도면 확정후로 변경을 용이하게 할 수 있도록 하였다.
9. 2차도면으로 결정된 평면 설계는 2차도면 확정후로 변경을 용이하게 할 수 있도록 하였다.
10. 2차도면으로 결정된 평면 설계는 2차도면 확정후로 변경을 용이하게 할 수 있도록 하였다.

구분	면적	비율
전체면적	11,800	
건축면적	2,018.04	
건축률	17.10%	
용적률	0.17	

Design
1/80
Date: 2018. 04.
Sheet Number: A-03-002
Scale: 84m² 단위세대 평면도 (확장형)
Drawn by: [Signature]
Checked by: [Signature]

동행건축사사무소 (주)나산건축
A-03-002-001-001
서울 광명구 광명로114
TEL: 1522-4440
FAX: 1522-4441

LIVING ROOM_ A.Type WOOD MOOD

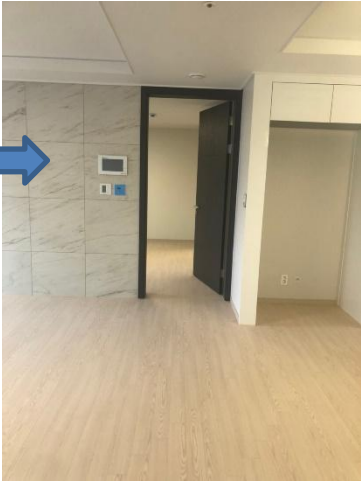
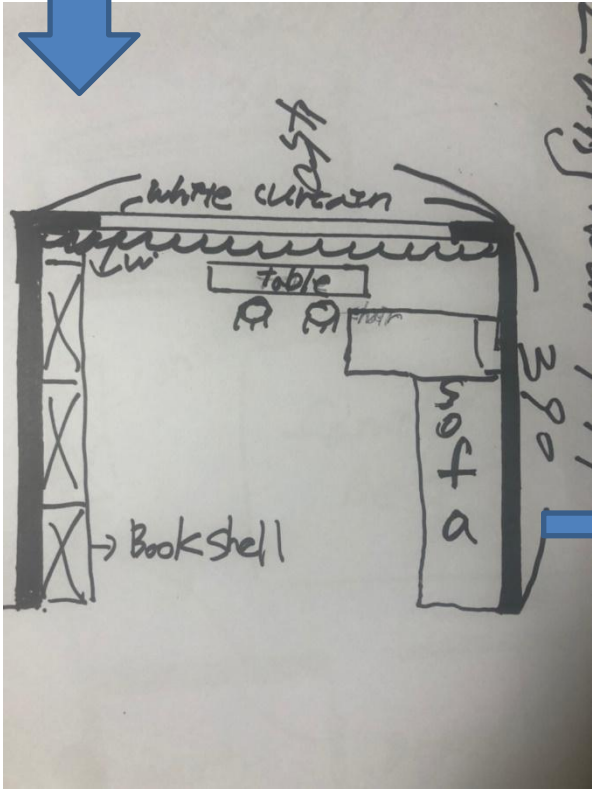

LIVING ROOM_ A.Type WOOD MOOD

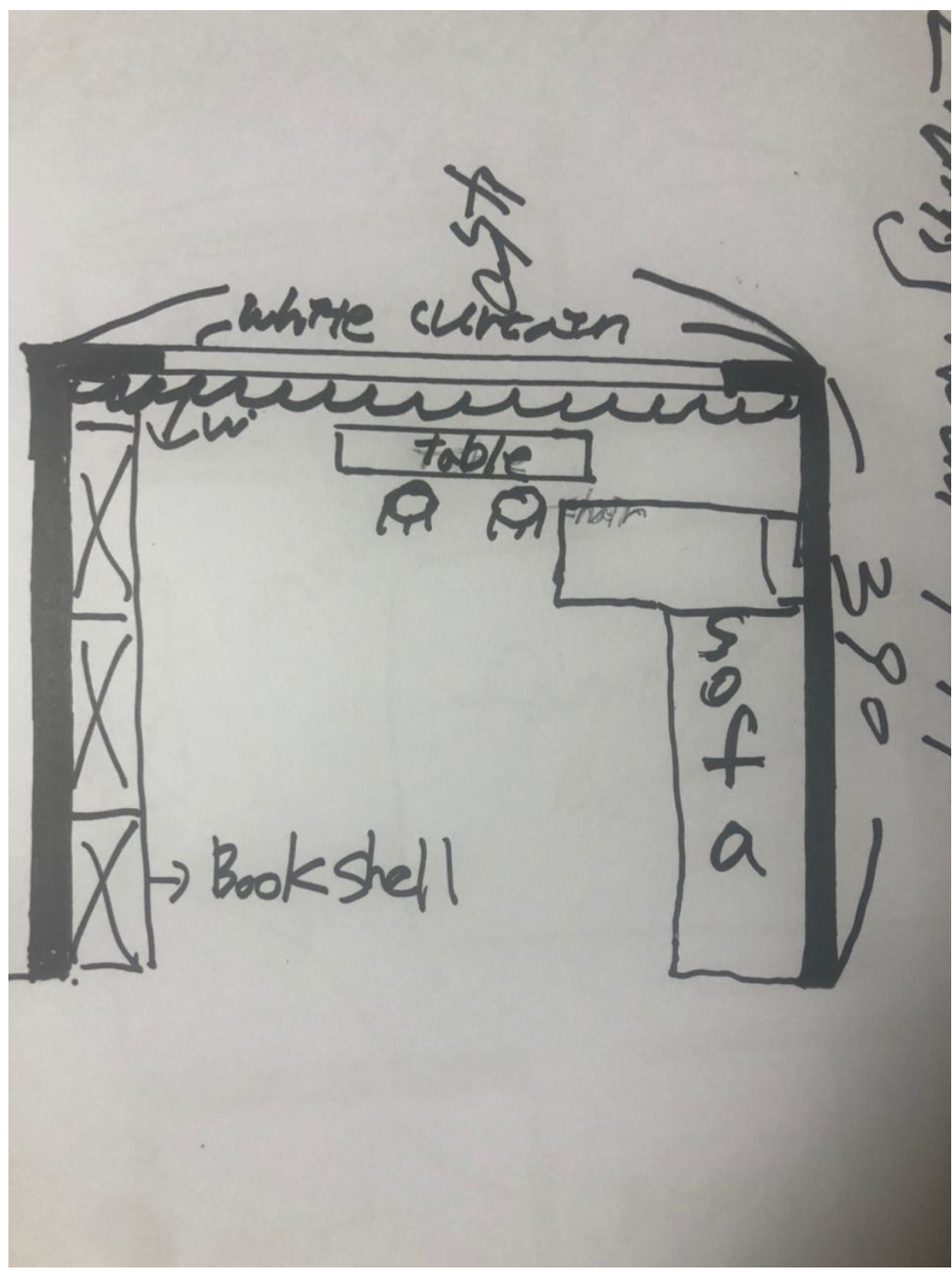

LIVING ROOM_ A.Type WOOD MOOD

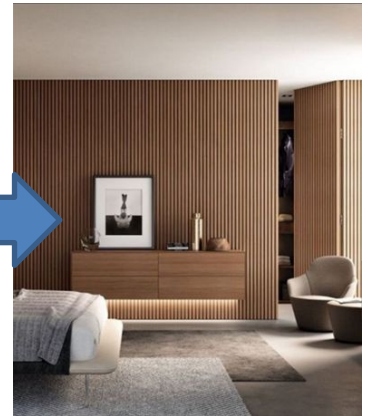
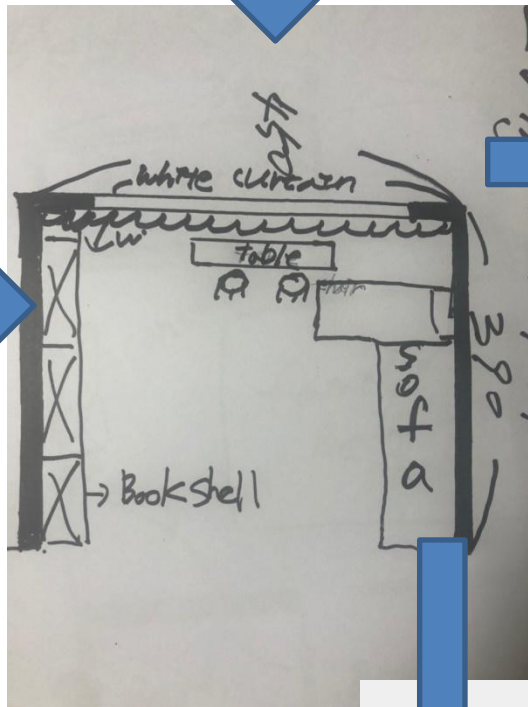

LIVING ROOM_ A.Type WOOD MOOD

Change to wood wall

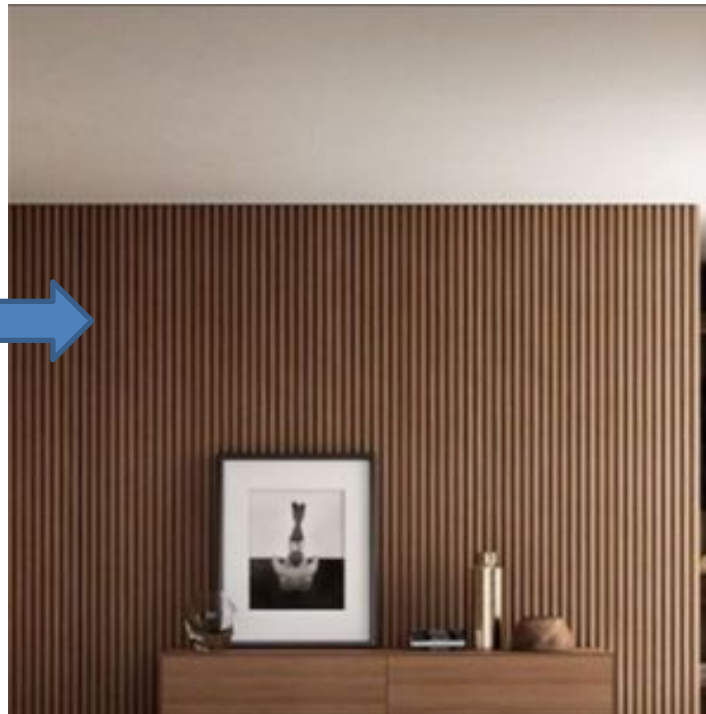
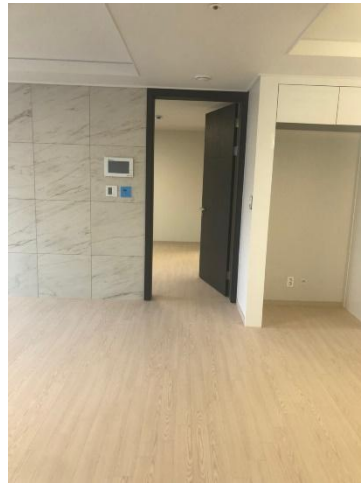
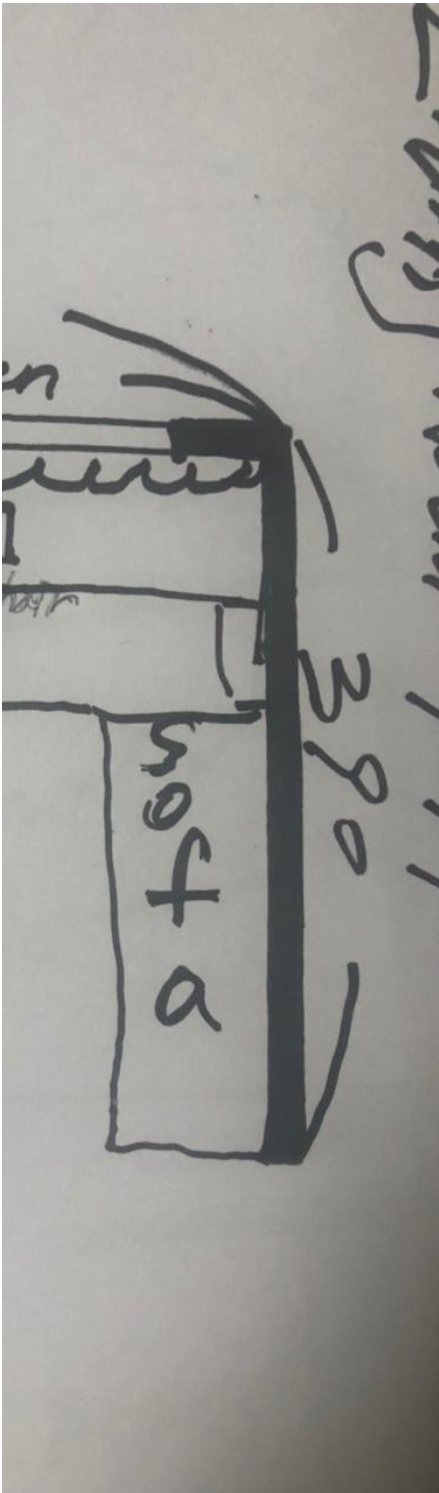

LIVING ROOM_ A.Type BOOK SHELL



H 170 W 3000
420



LIVING ROOM_ A.Type SOFA

SOFA SHAPE H680 L
1820



SOFA
COLOR



LIVING ROOM_ A.Type WHITE TALE +WOOD CHAIR

TABLE H750 L 1200
D600

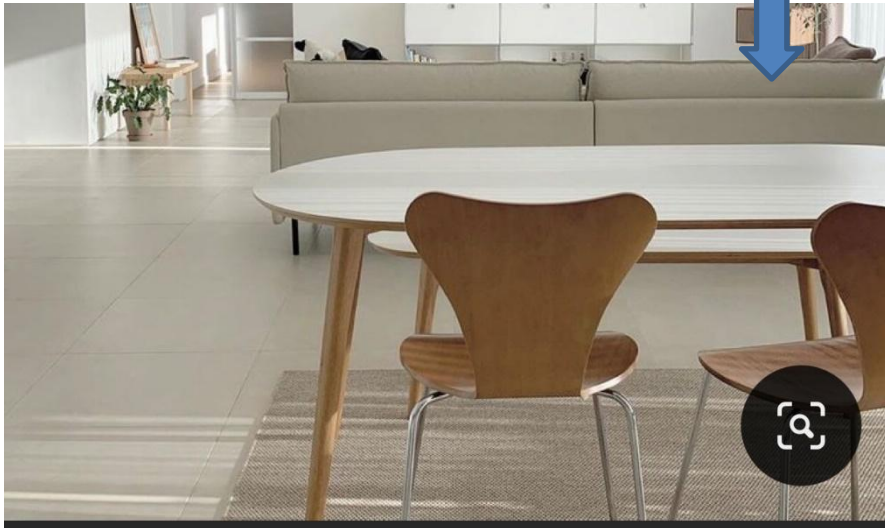

BROWN WOOD
CHAIR 2PCS

LIVING ROOM_ BType WHITE &BLACK

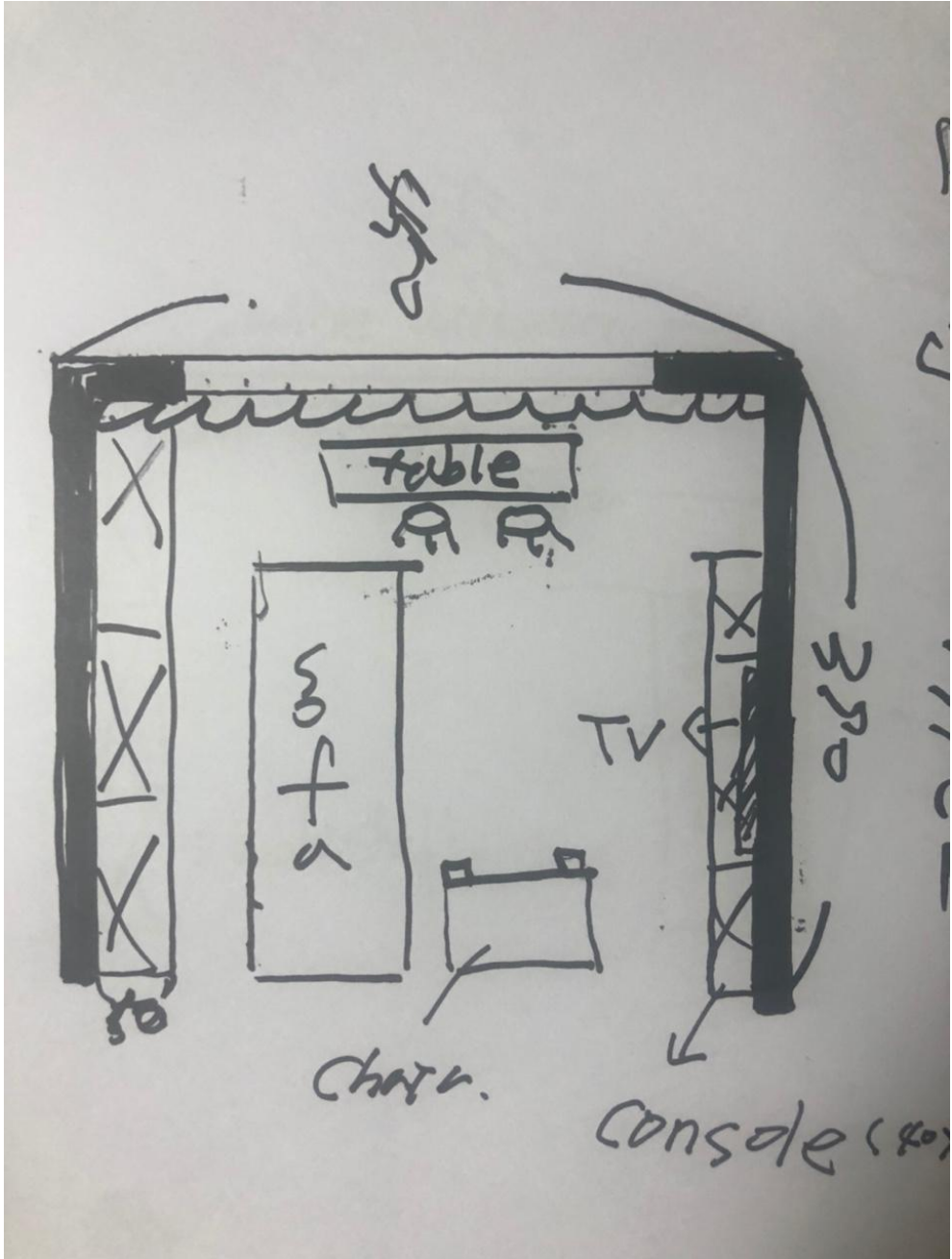

LIVING ROOM_ A.Type WHITE BLACK MOOD

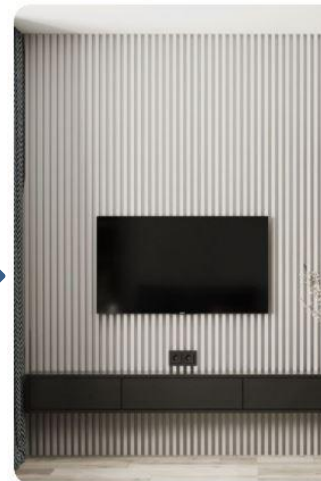
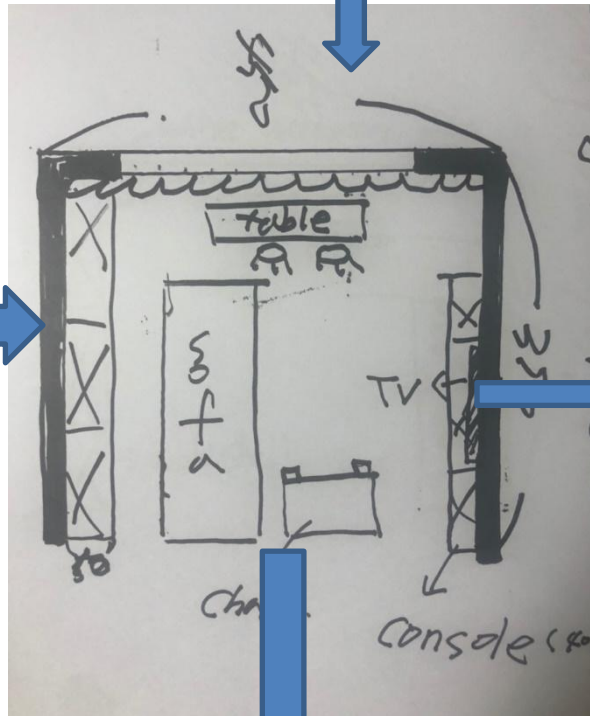

LIVING ROOM_ B.Type BOOK SHELL



H 170 W 3000
420



LIVING ROOM_ B TYPE WHITE AND BLACK

Change TO WHITE WOOD WALL

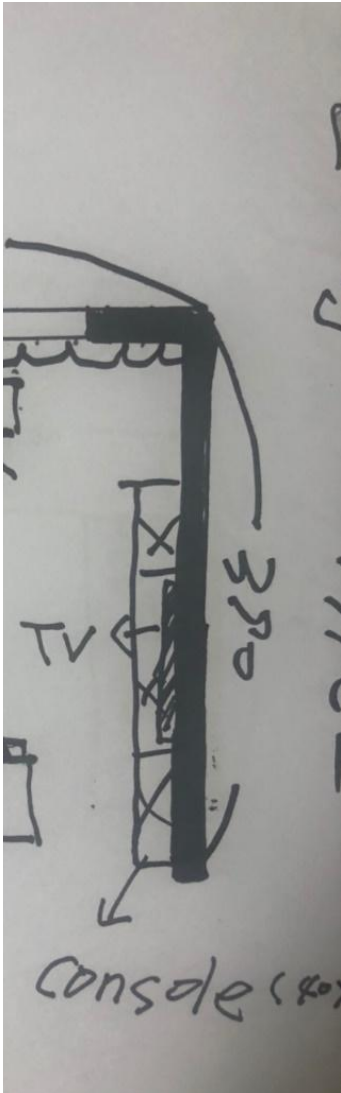

LIVING ROOM_ BType WHITE &BLACK SOFA



SOFA COLOR



LIVING ROOM_ A.Type WHITE TALE +WOOD CHAIR

TABLE H750 L 1200
D600



BLACK CHAIR
2PCS



LIVING ROOM_ both type light

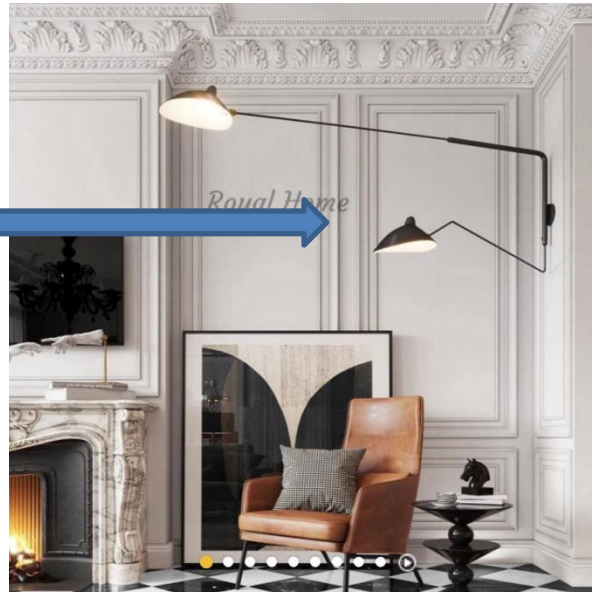
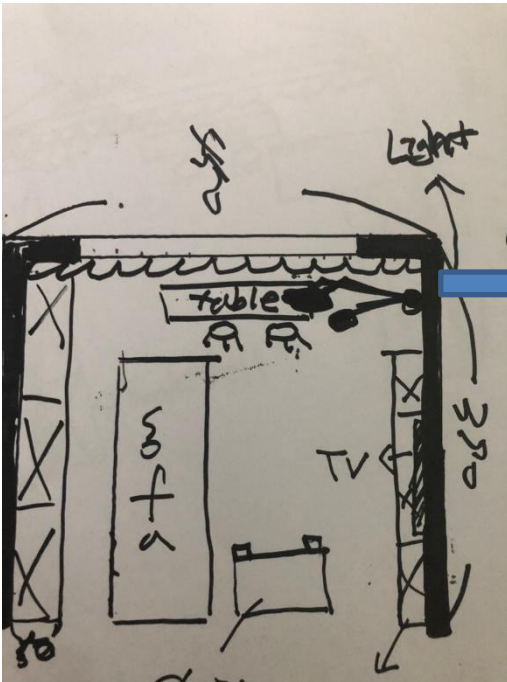

LIVING ROOM_ both type tile floor

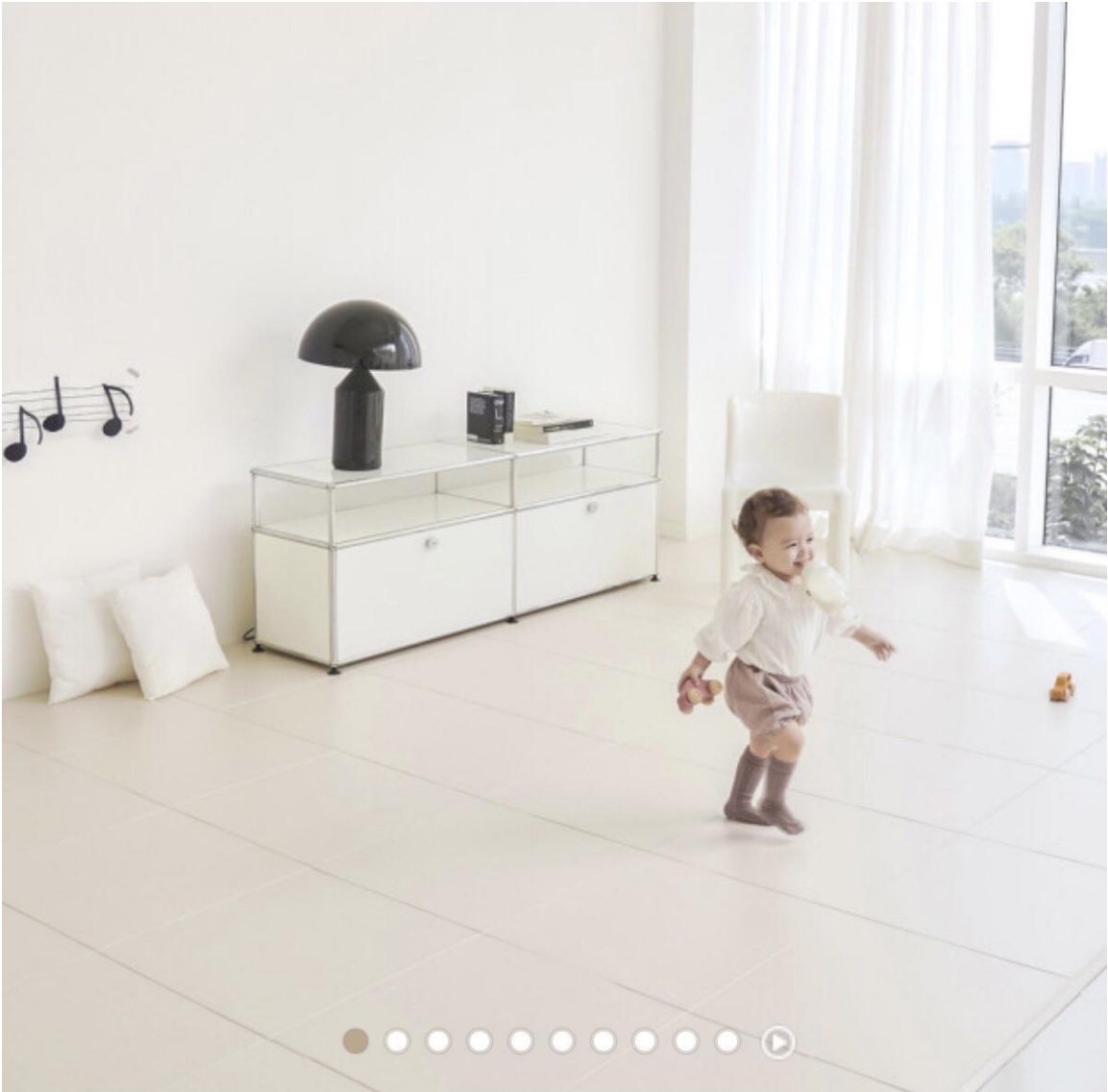

DINING ROOM

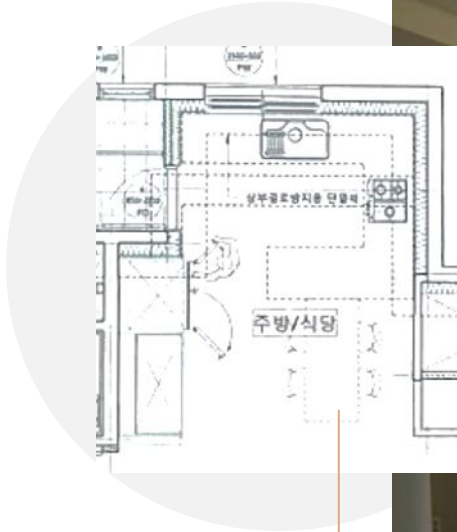

DINING ROOM_

CHANGE TO WOOD ISLAND



DINING ROOM_

ADD TABLE

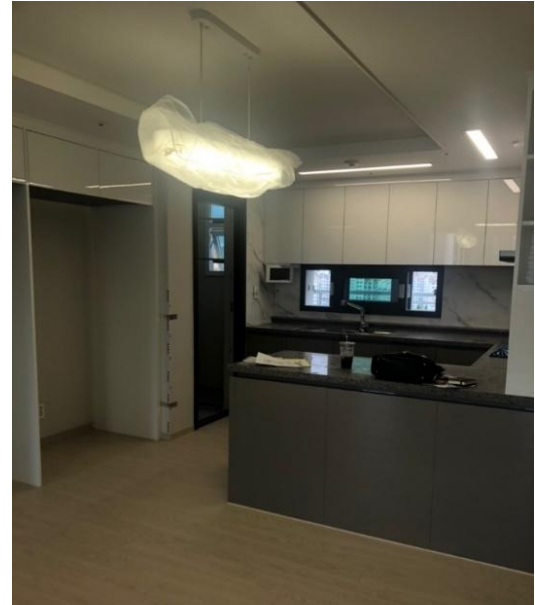
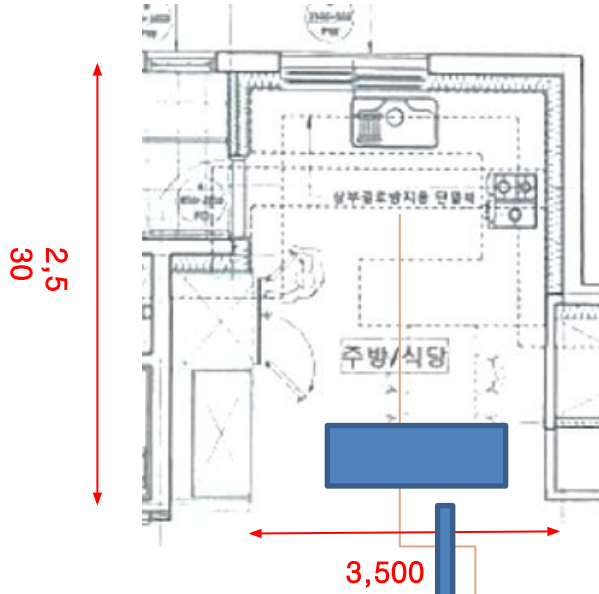

DINING ROOM_

CHANGE LIGHT

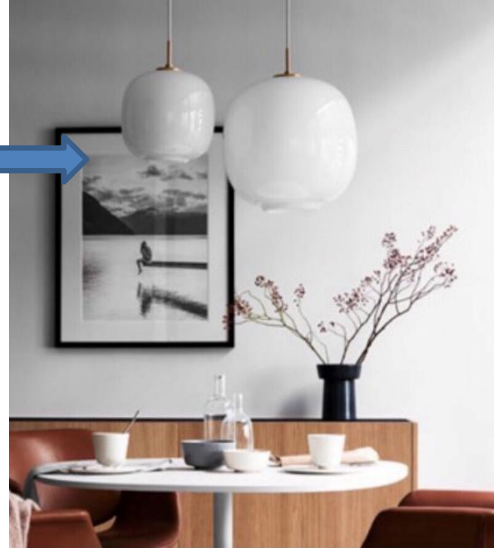

KIDS_ROOM

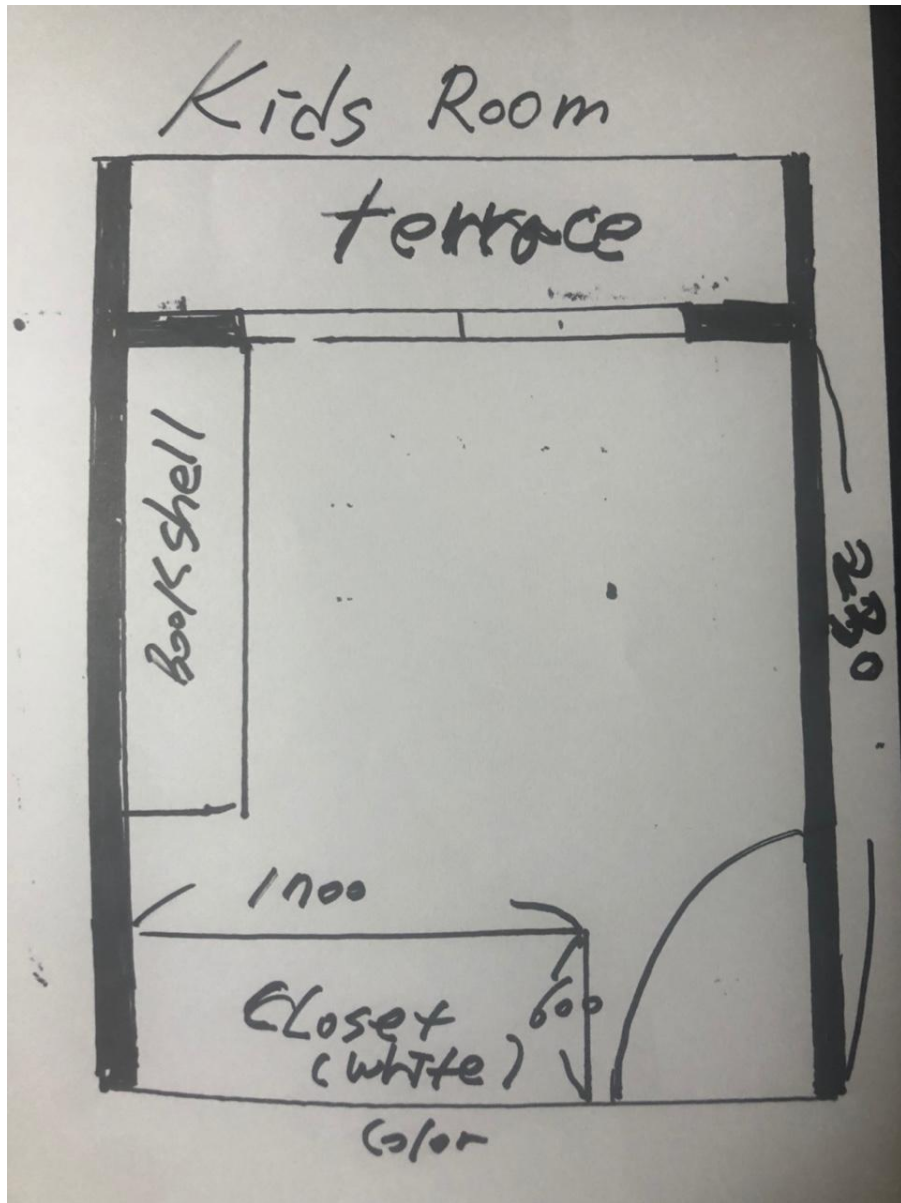

TERRACE + KIDS_ROOM

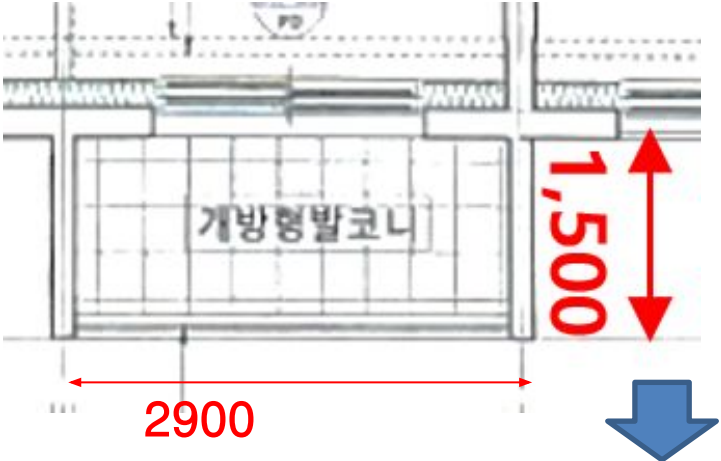

KIDS_ROOM

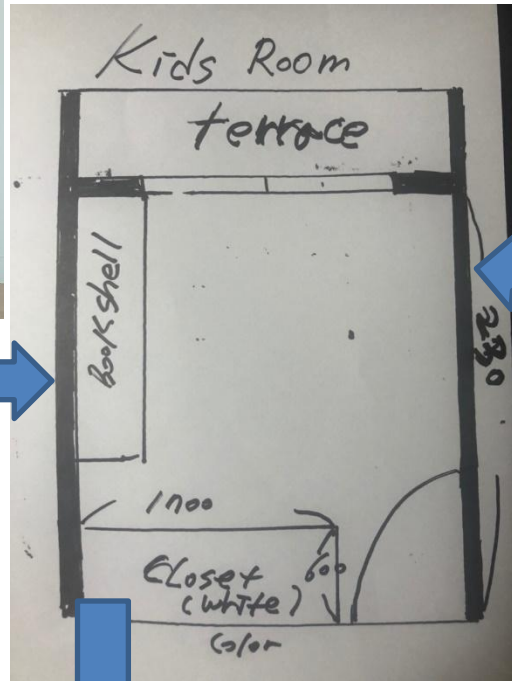

KIDS_ROOM book shell

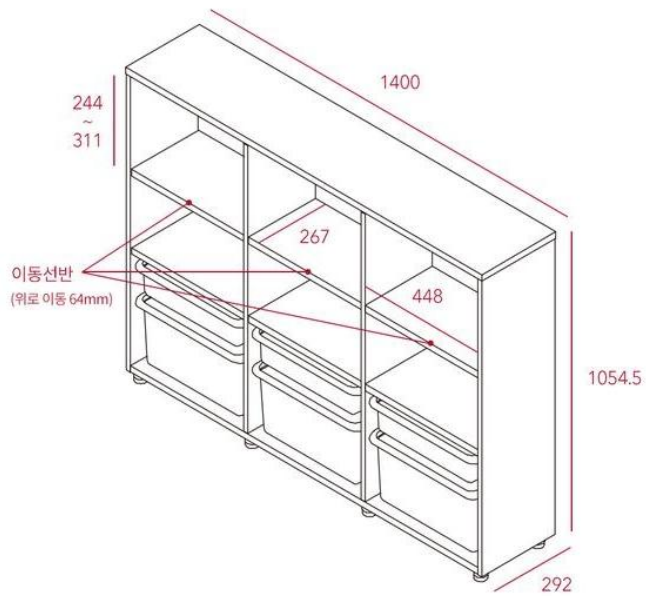

KIDS_ROOM

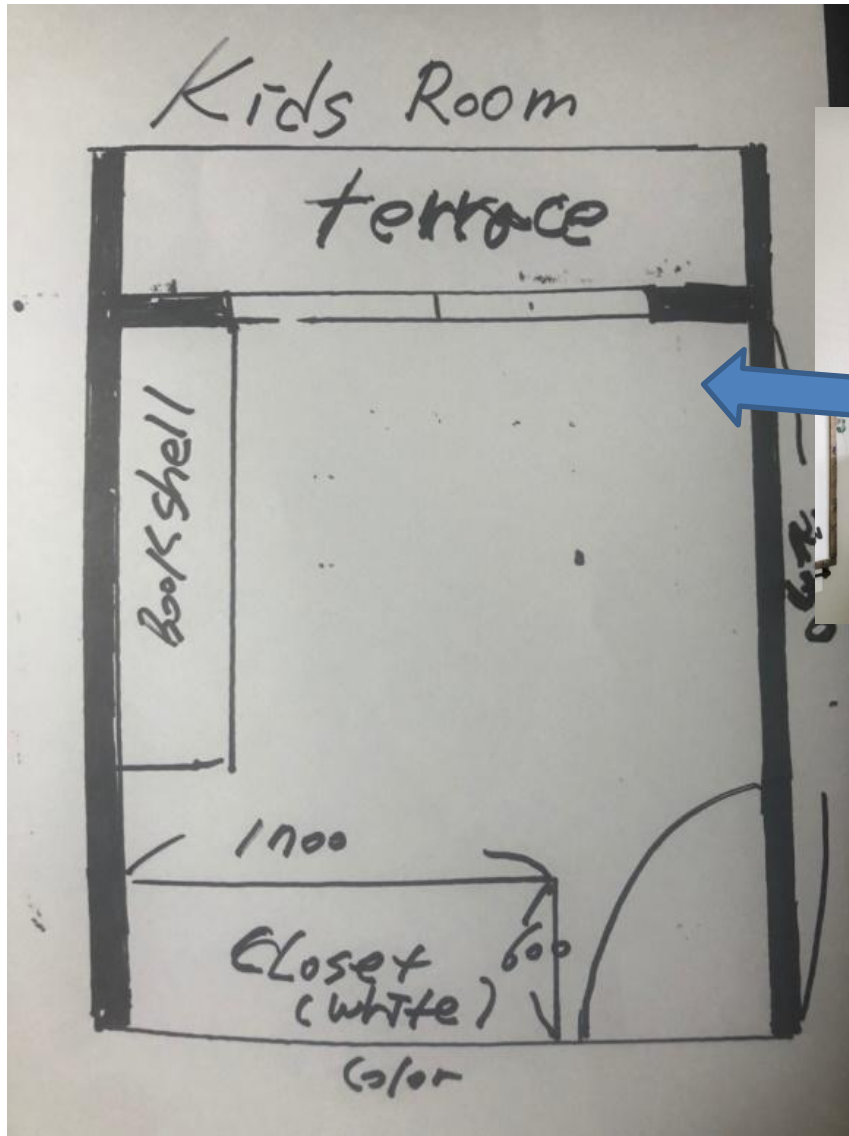

TERRACE_ little garden

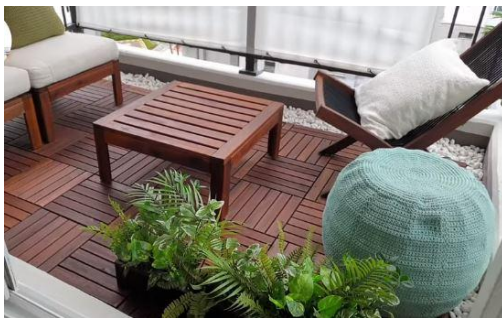
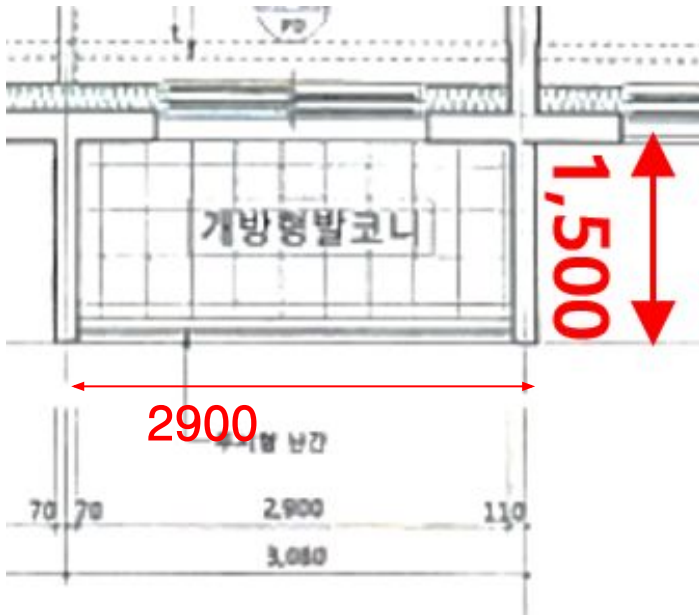

120
0

TERRACE_SOFA

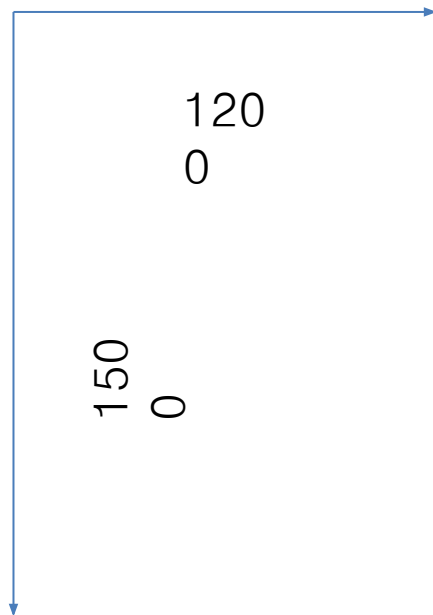

STUDY_ROOM

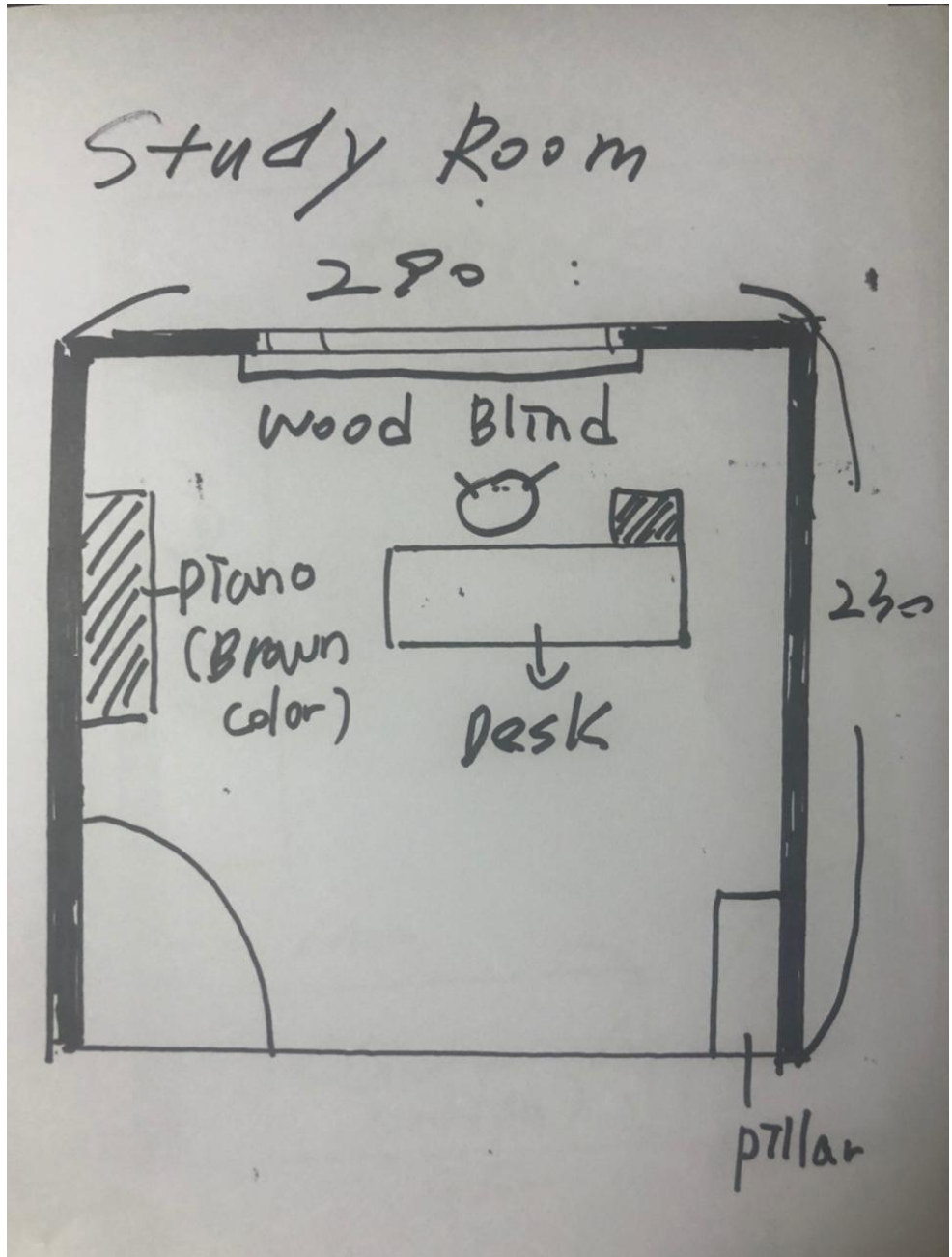

STUDY_ROOM

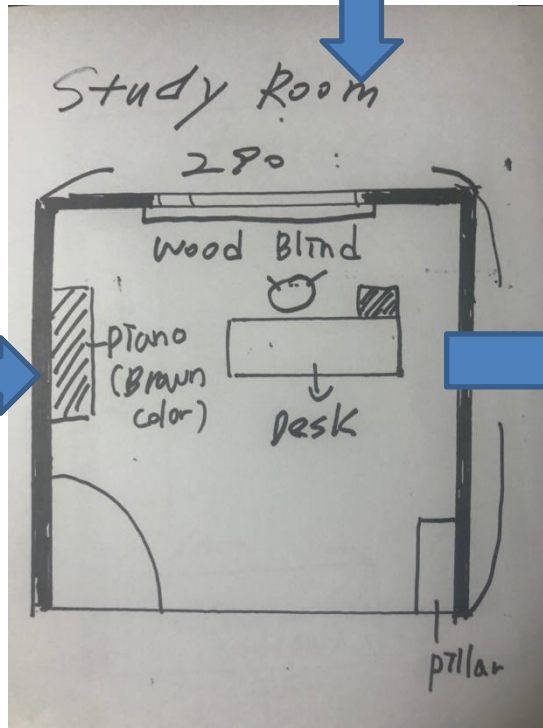
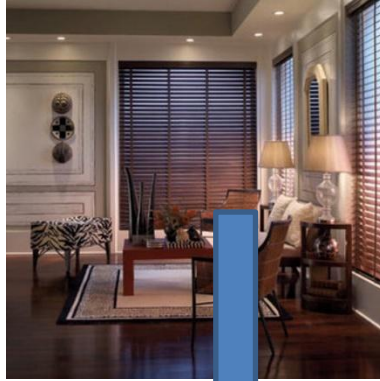

STUDY_ROOM PIANO



STUDY ROOM DESK



● URBAN WOOD 2 DRAWER DESK

#Color - CAMEL BROWN

#Size(mm) - W1200 X D600 X H720

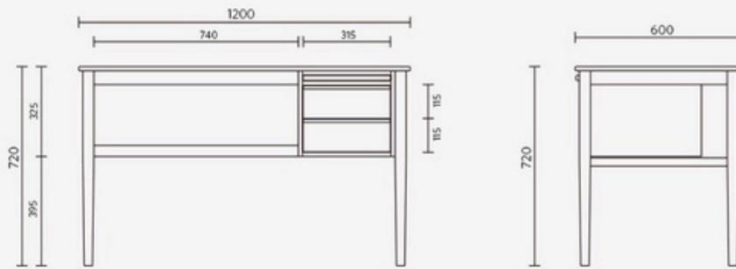

STUDY ROOM rug



사이잘룩 다크베이지



BED ROOM LAYOUT

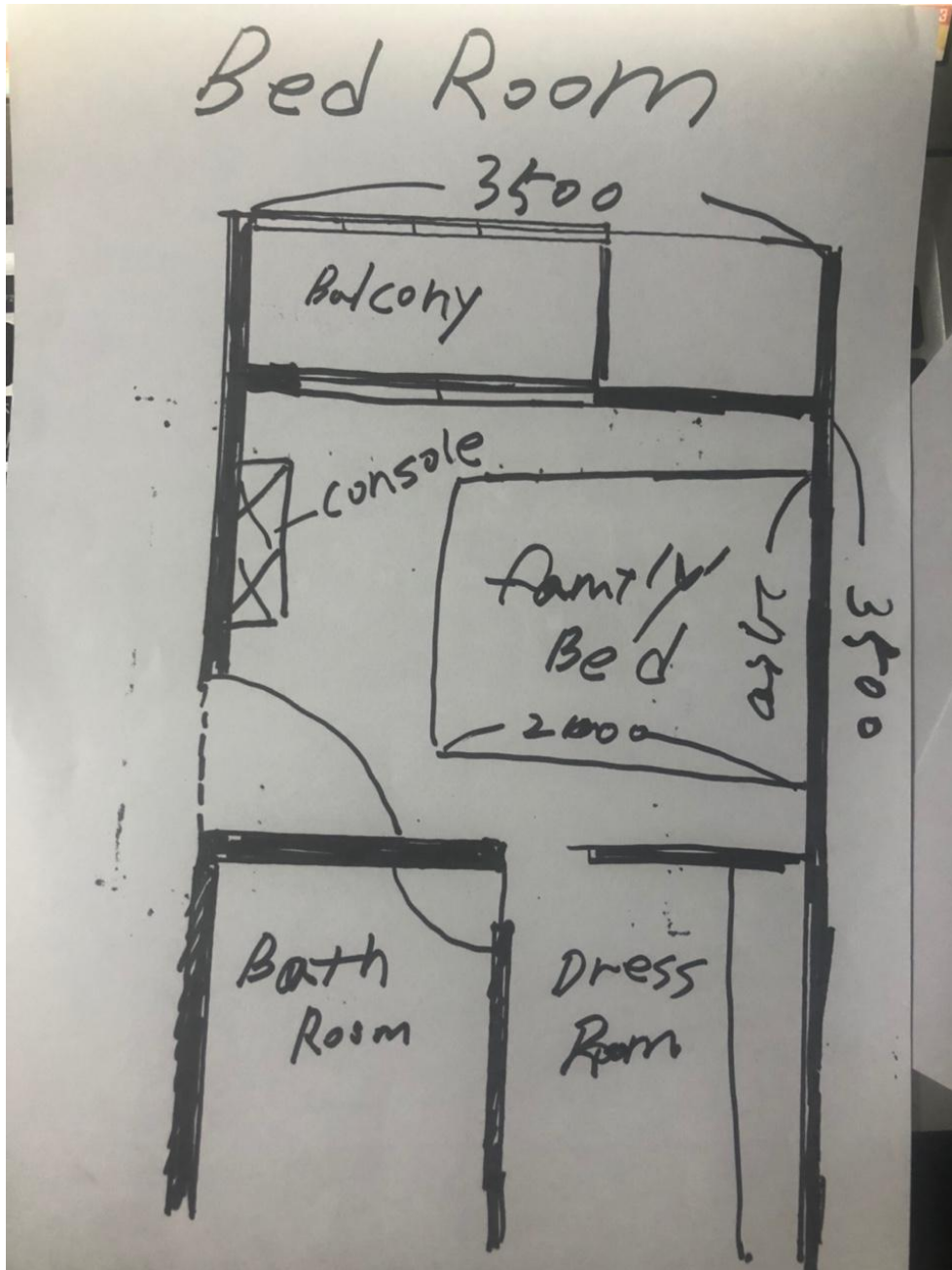

BED ROOM LAYOUT

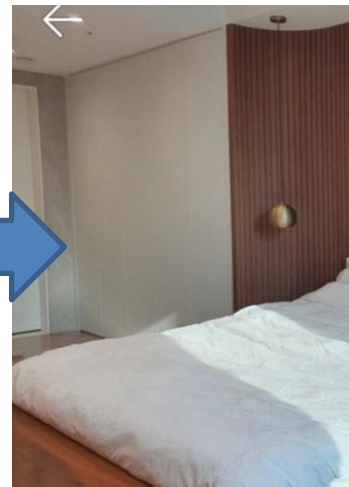
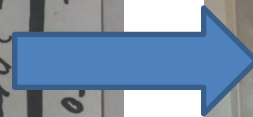
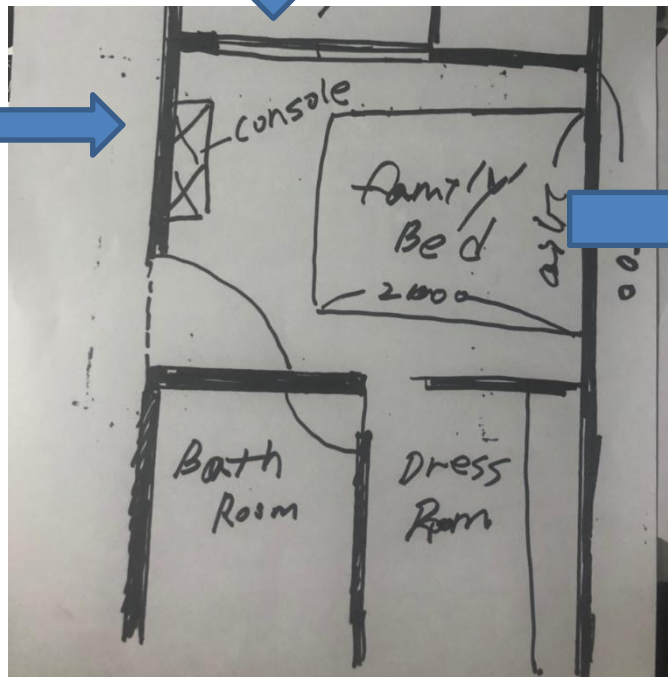
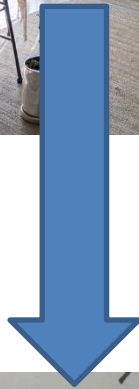

BED ROOM double curtain

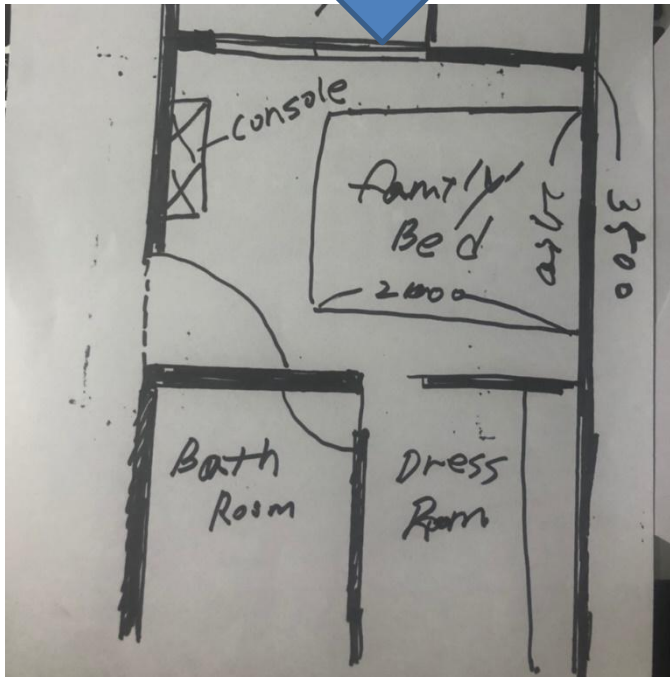

BED ROOM LAYOUT



Change TO WHITE WOOD WALL
+ side light



BED ROOM LAYOUT



Low family bed

2750*2000



BED ROOM LAYOUT

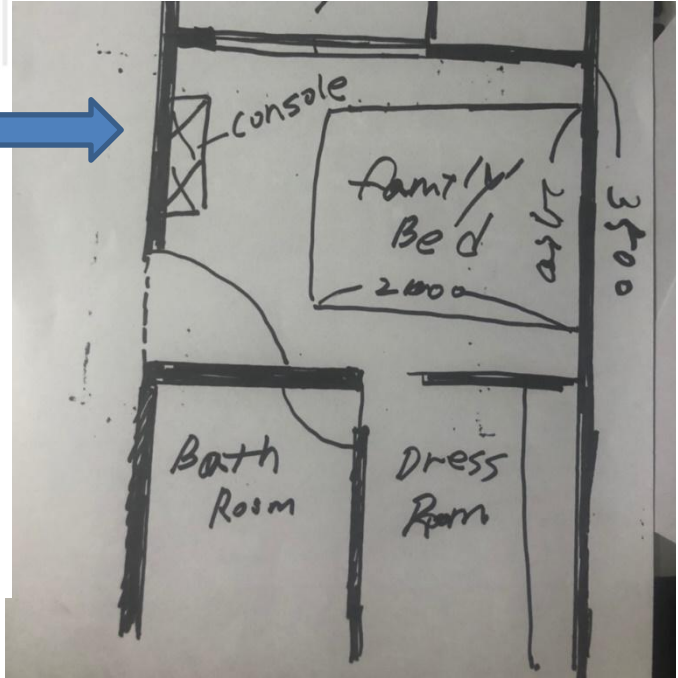

SPECIFICATION

NORWEGIAN WIDE 6 DRAWERS

노르웨이지안 6칸 와이드 서랍장

원산지 : 인도네시아(OEM)

수입원: (주)동원교역

사이즈: 1185X400X755 (mm)

소재: 원목, MDF, 천연두늬목

색상:

허니컬러

*거울은 별도로 구입하셔야 합니다.

