

# QUESTIONS

## HOW MANY?



## WHAT?



## WHERE?



ESL/EFL Resources for Teachers

**ES** English.com

[www.mes-english.com](http://www.mes-english.com)

**What**

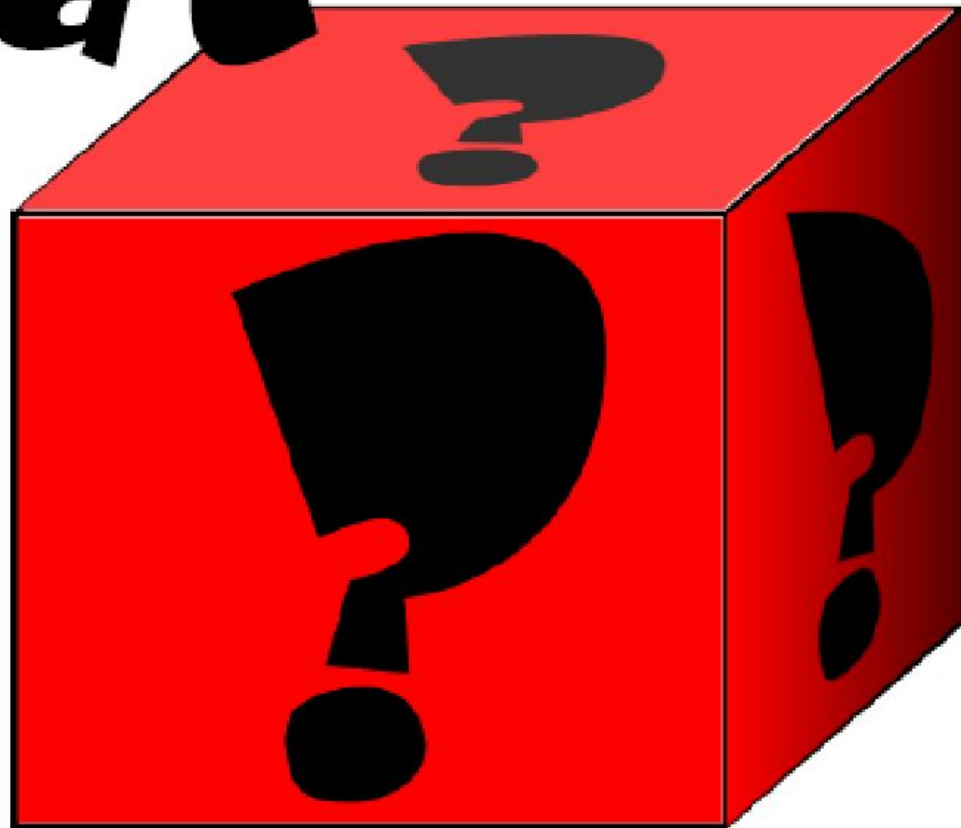

# Who

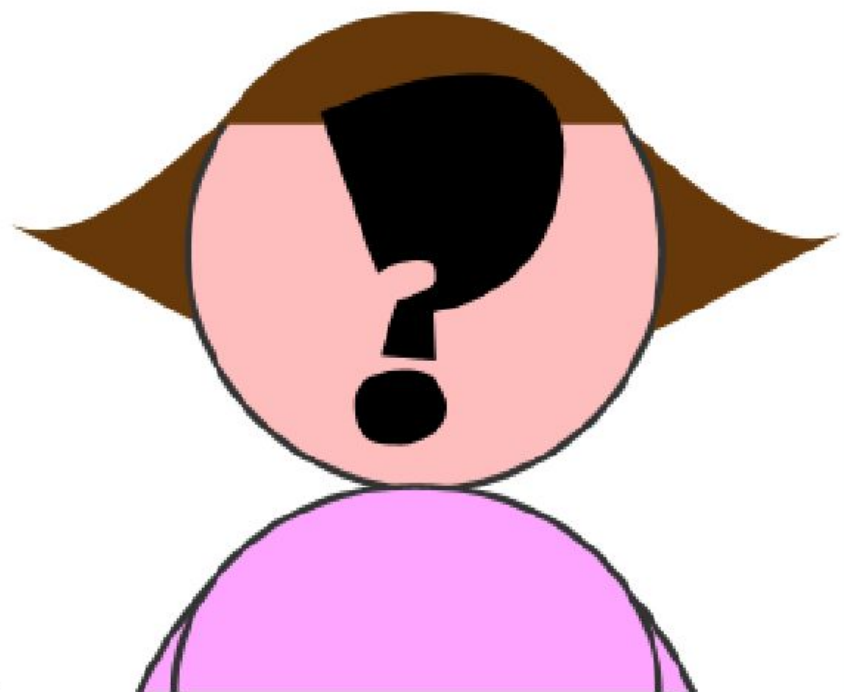
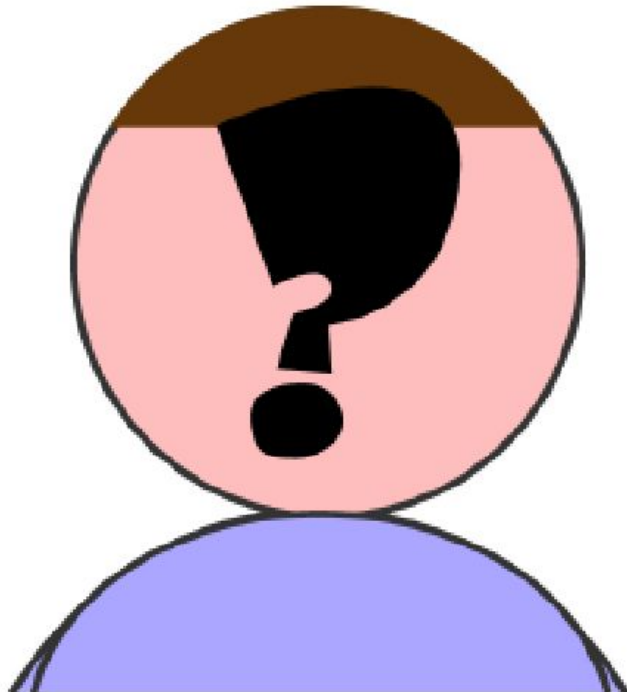

# where

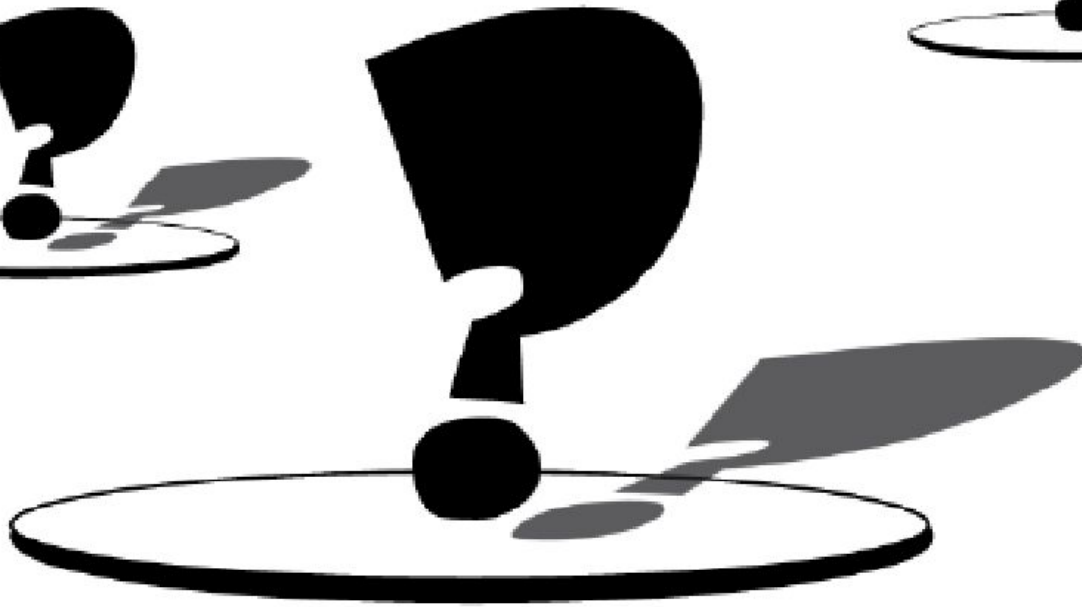

# Which



# When

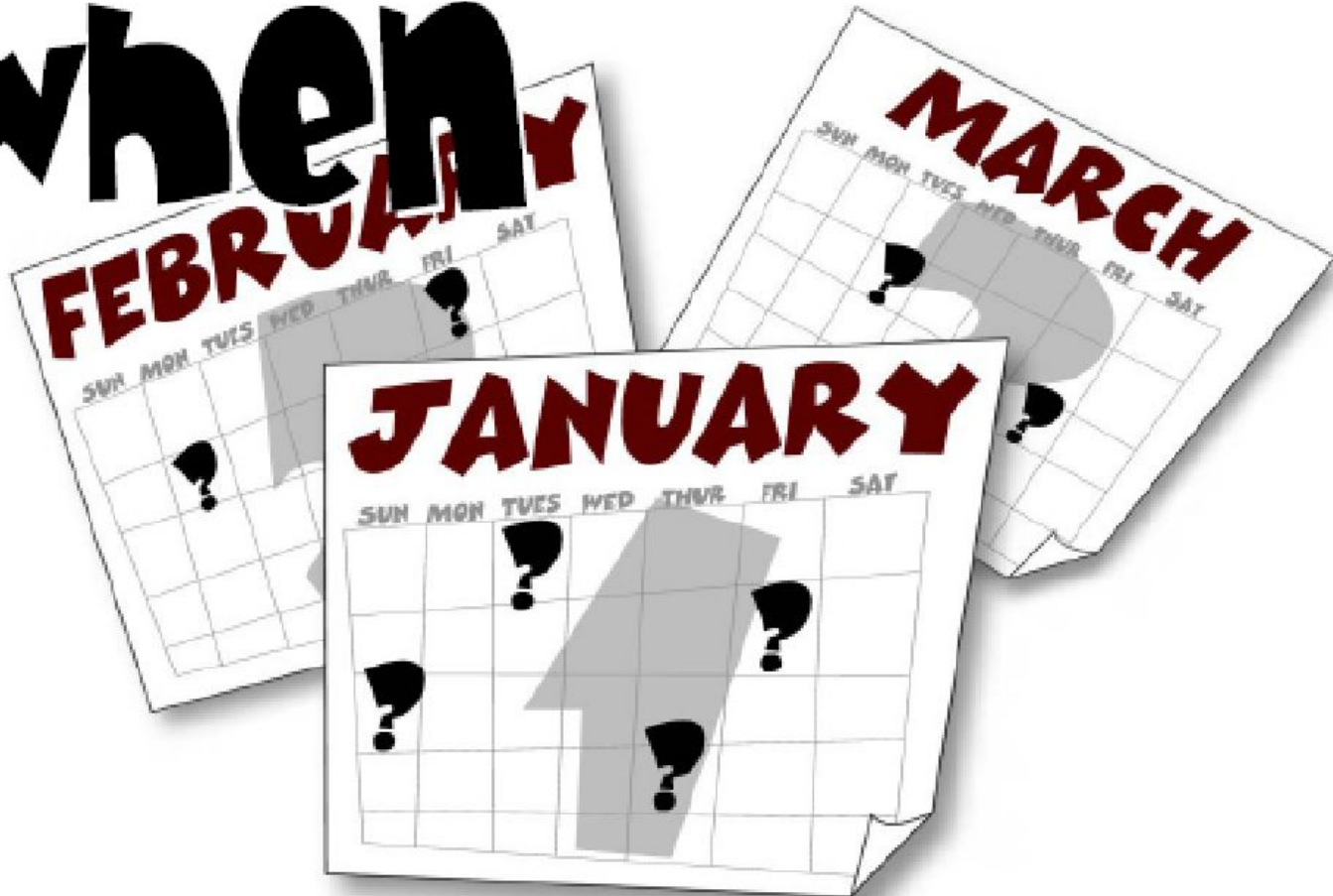

# HOW MANY

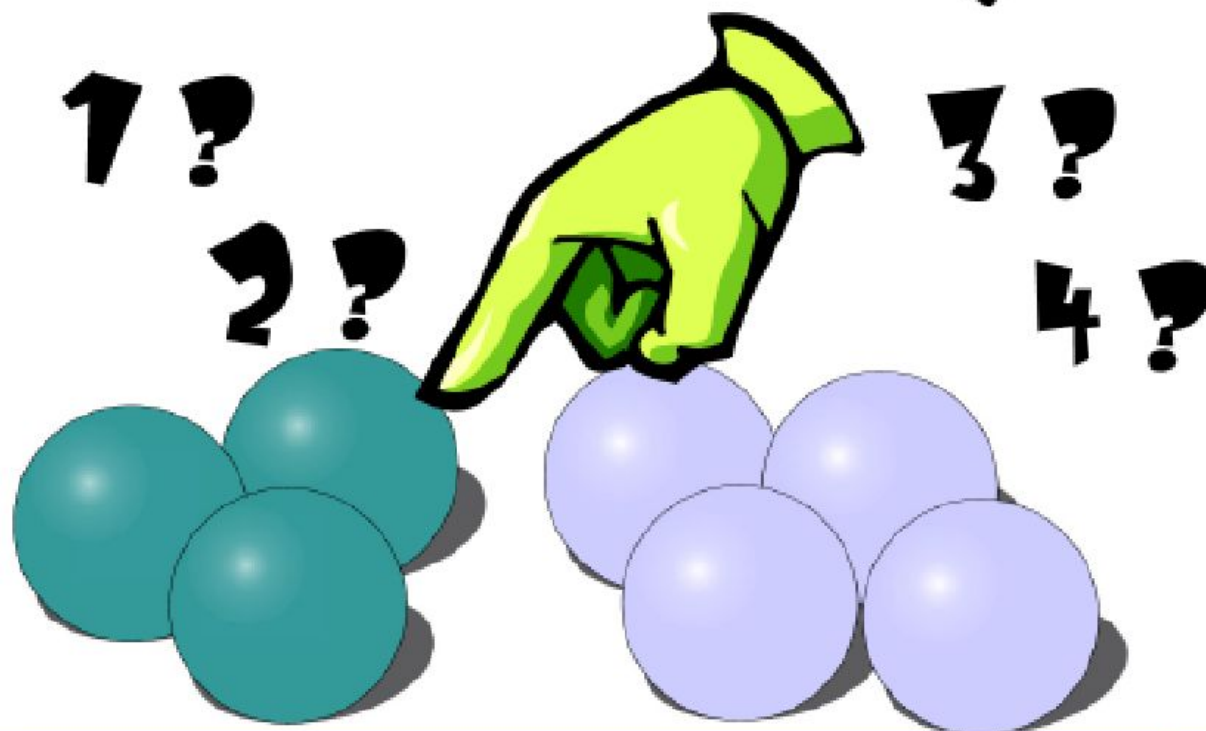

# HOW MUCH

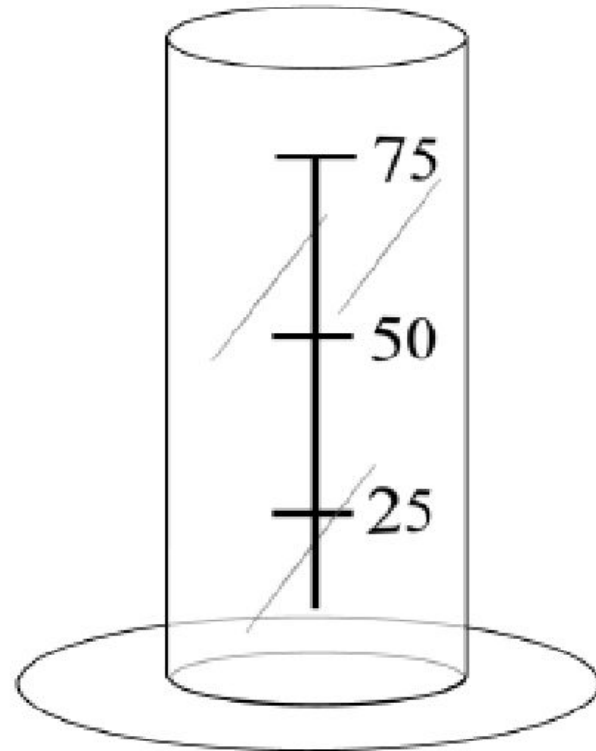
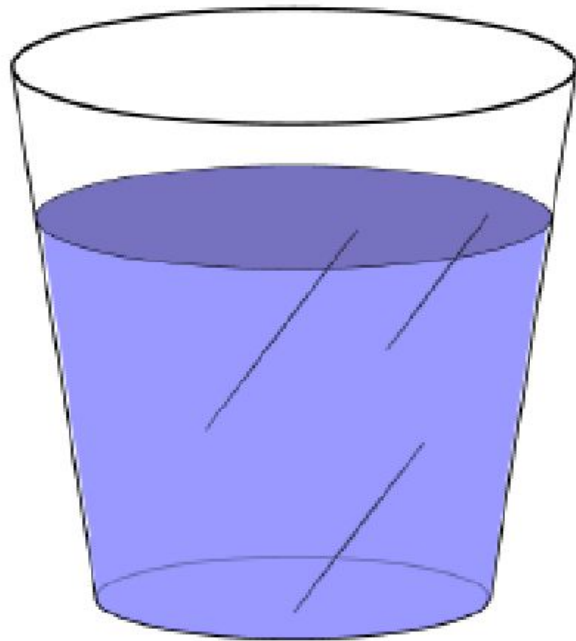



# HOW MUCH



# What time

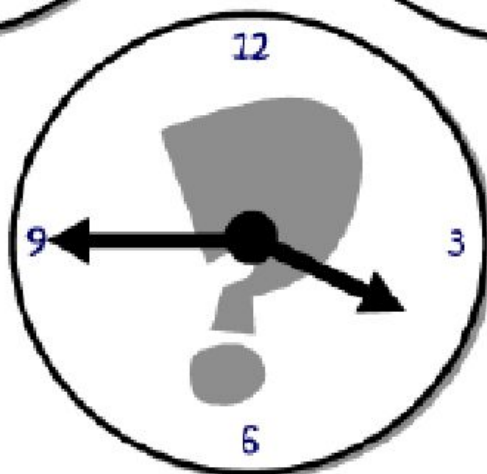
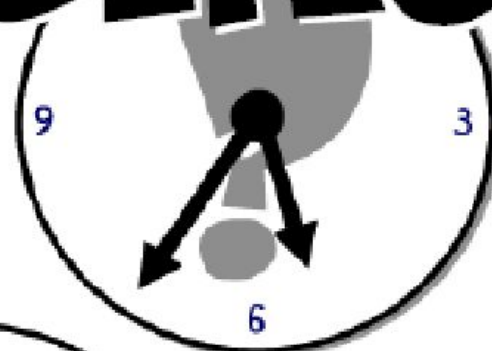
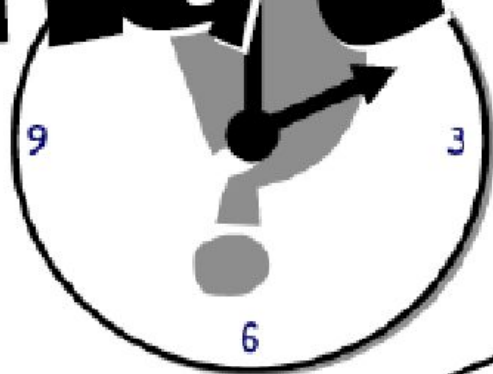



# HOW LONG

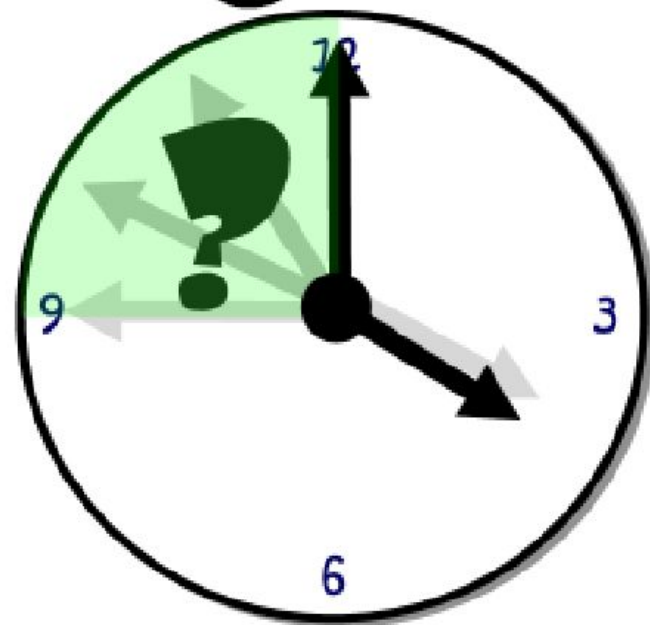

# HOW LONG

