

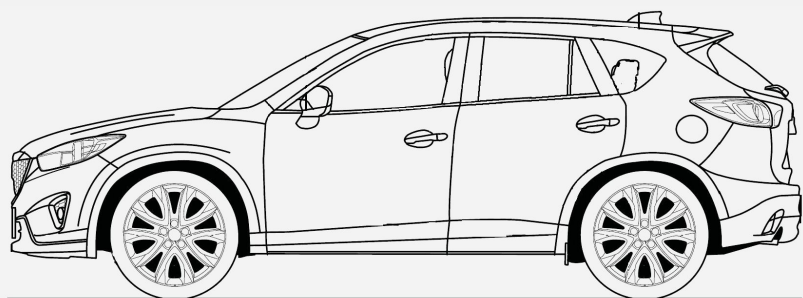

ОТЗЕТ
О
МРОБЕРКЕ
АВТОМОБНУ

R

O[EHKA AUTOSCORING



Hob n abtomobinna	1	3 foga	5 net	7+
100	fog 80	80	70	60



Coctoe.ne

7/10
kysoba



7/10
Coctoe.ne mogkamot.ofo
otceka



8/10
Coctoe.ne cano.a



9/10

Pesynatat kommadtep.on
gnaf.octnkn

8/10



3nektpnka n
cbet

7/10



Tect-gpanb



8/10

Coctoe.ne topmos.on cnctem



7/10

Nn. n gnckn



6/10

Pesynatat ocmotpa .a mogaem.nke

7/10

NTOTOBA^a
O[EHKA

67Z90

+ 1 bnageney, + 35 t c. km mpo6ef (mogtbepxge.), + kysob b sabogckom okpace,
+ mon.ae nctopne obcnynbna.ne, + makcmana.ae kommnektayne Supreme + ye.a 1 150
000 p.

- ecta same-a.ne mo kysoby (cm. 6nok Coctoe.ne
kysoba)

- tpe6yetce xnm-nctka cano.a

\$ ns 6nnxanmnx bnocxe.nn tonako mpoxoxge.ne TO 60 t c. km. (opne.tnpobo-.ae ctonmocta 15 000
py6.)

Pekomehyem k mokymke mo saebnehhoj yehe.

\$OTOTAUEPE^a.
3KCTEPbEP
ABTOMObHu^a

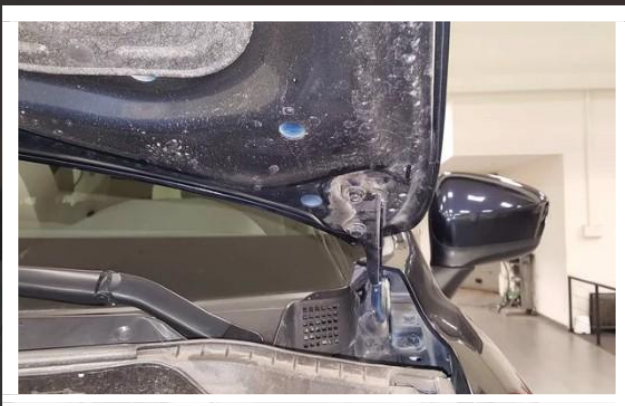

Ob[A^a HH\$OPMA[H^a Ob ABTOMObHuE

бOK7MEHT^a
H @PHбH7ECKA^a
7HCTOTA

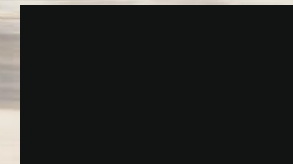
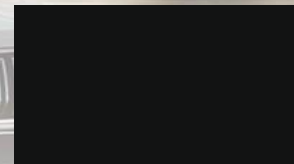
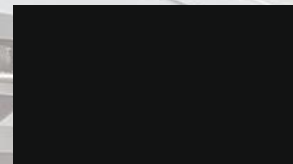
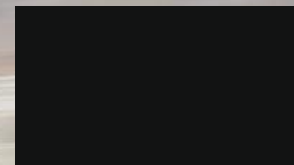

Mapka:

Mazda



Mogena:

CX-5



\bet (mpnopnteth n)

Abtob 6op: Cepe6nnt n/Cep n uep. n ben n Kpac. n 3ene. n Cn.nn bexeb n/kopn-.eb n Hent n/sonoton qpyfon He bax.o



Tog b mycka (ot)

Abtob 6op: Hob n abtomo6nna 2018 2017 2016 2015 2014 2013 2012 2011 2010 2009 2008 2007 2006 2005 2004 2003 2002 2001 2000 He bax.o



KNN

Abtob 6op: Abtomat MKNN Bapnatop Po6ot He bax.o



Tnm ky>oba

Abtob 6op: Cega. Xet-6sk V.nbeSCAN Knocobeh B.egopox.nk \$ypfo. Mn.nbs. unmyns. Ka6pnonet Kyme Pogctep Nnkam He bax.o



Tnm tomnba

Abtob 6op: behsnh qnsena Tn6png Tasoboe o6opygoba.ne He bax.o



O6aem gbnfatene:

2.
0



Npnbog:

Abtob 6op: Nepeg.nn 3ag.nn Non. n Nooknd-aem n monh n He bax.o



Makk. Ctonmotta *

1 200
000



Npo6ef (go)

Abtob 6op: bes mpo6efa 10 000 20 000 30 000 40 000 50 000 60 000 70 000 80 000 90 000 100 000 120 000 150 000 170 000 200 000 He bax.o



Oco6ehhoctn kommnektayn n qomonhntenah e tpe6obahne



Kak bac >obyt? *



Tene\$oh *



3nektpohhae mo-ta *



VIN :

RUMKE8978FV0484
81



NTC:

Opnfn.an



Konn-ectbo bnaenayeb mo NTC:



Cpok bnagehne abtomo6nne mocneghnm co6ctbehnkom c

20 03 2015
qq MM TT



Cepbnchae khnhka:

3nektpo..ae



Kommehtapnn mpogabya mo o6cnyhnbahnd abtomo6nne



Konn-ectbo knd-en



Npobepka ha dpngn-eckyd -nctoty



Abtomo6nna he -ncnntce b po> cke/yfohe



Npongeha mpobepka mo 6a>am TNbqq o hanohehnn ofpahn-ehnn ha pefnctpaynohh e genctbne (b t.-. peectp >anofob)



Abtomo6nna b ka-ectbe takcn he ncmona>obance

COCTO^aHHE K7SOBA



Cmncok same-a.nn



Hnxhne snemeht kysoba cnpaba

- yapamnha

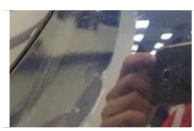

3aghnñ 6ammep

- yapamnha



Nepeghee nebae gbepa

- he>ha-ntenahae bmetnha



Hnxhne snemeht kysoba cnpaba

- yapamnha

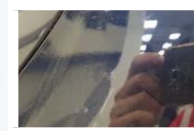

3aghnñ 6ammep

- yapamnha



Nepeghee nebae gbepa

- he>ha-ntenahae bmetnha

Kapta same-a.nn

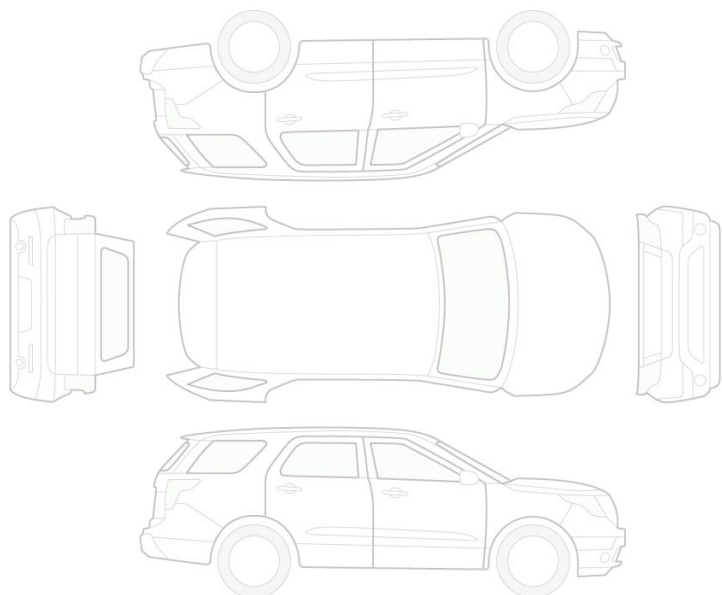

Konn-ectbo getanen
mocne pemohta



Ka-ectbo mpobegehhofo
pemohta

Otnn-a.o
e

Kpemehh e snemeht 6e>
mobpegehnn n cnegob
gemohtaha

qa Het

Mapknobkn ctekon
cobmagadt

qa Het

Bngnm e mobpegehne
ky>oba



O6yee coctoehne uKN
(otcytctbne cetkn,
matoboctn, b ybetahne
kpackn):

Xopome
e

\$OTOTAuEPE^a.
COCTO^aHHE
K7SOBA

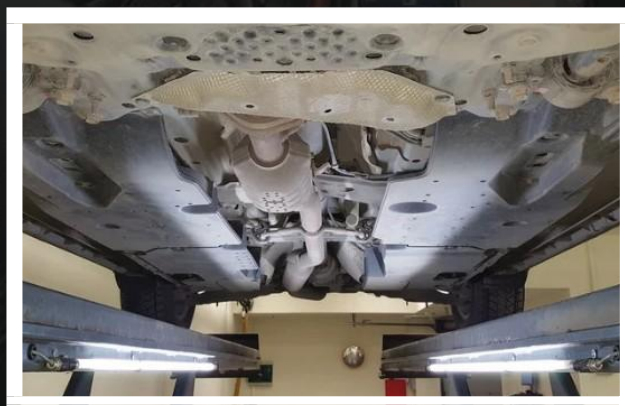
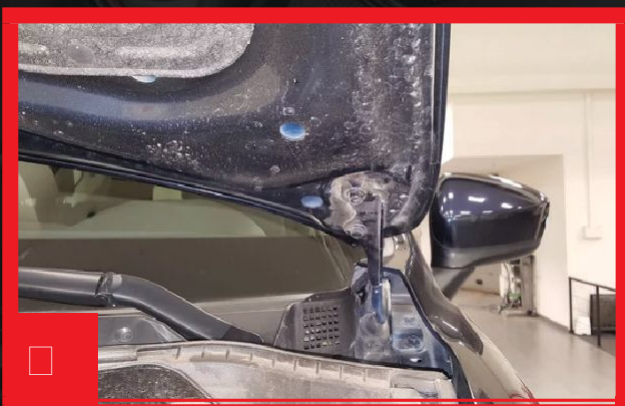

СОСТОЯНИЕ САУОЛА



Смнчок same-a.nn



Нhxhne snemeht kysoba cnpaba
• yapamhha

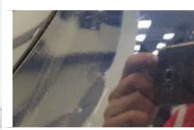

3aghnñ 6ammep
• yapamhha



Неpeghee nebae gbepa
• he>ha-ntenahae
bmetnha



Нhxhne snemeht kysoba cnpaba
• yapamhha

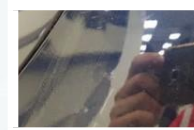

3aghnñ 6ammep
• yapamhha



Неpeghee nebae gbepa
• he>ha-ntenahae
bmetnha

Капта same-a.nn



5-местная модель



7-местная модель

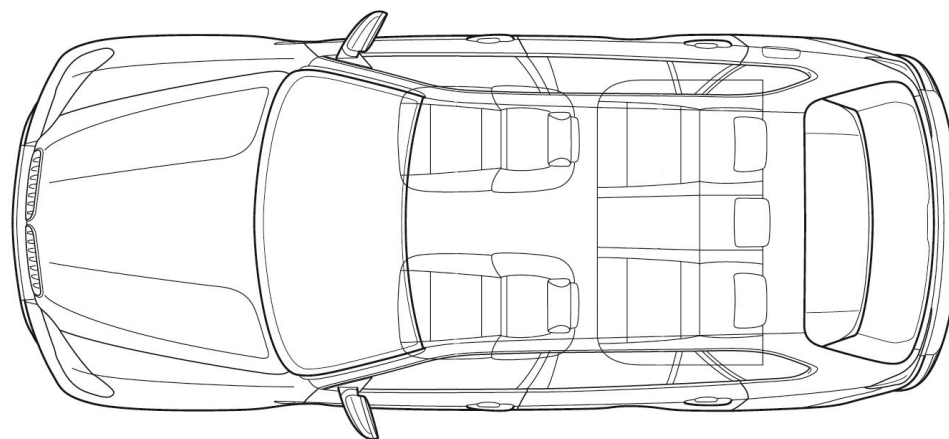

**\$OTOTAUEPE^a.
COCTO^aHHE
CAUOHA**

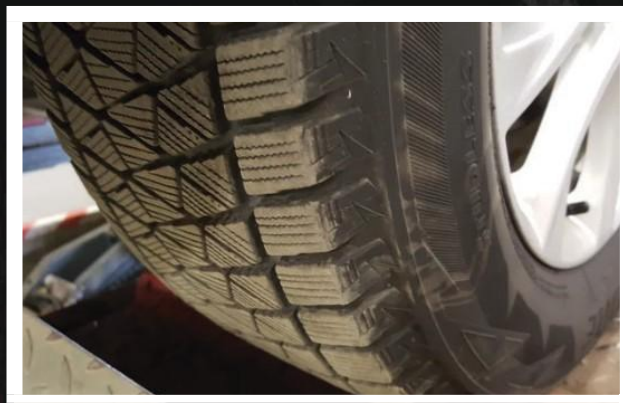
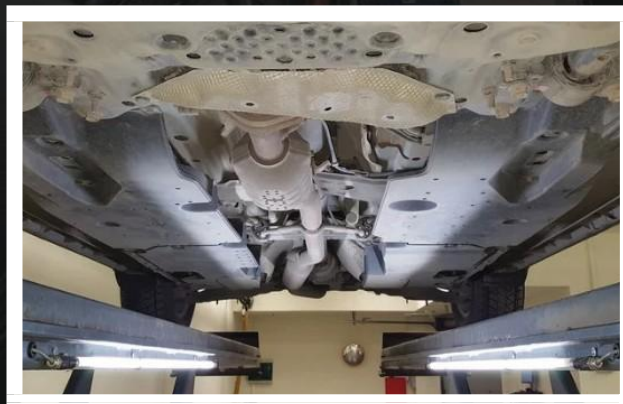
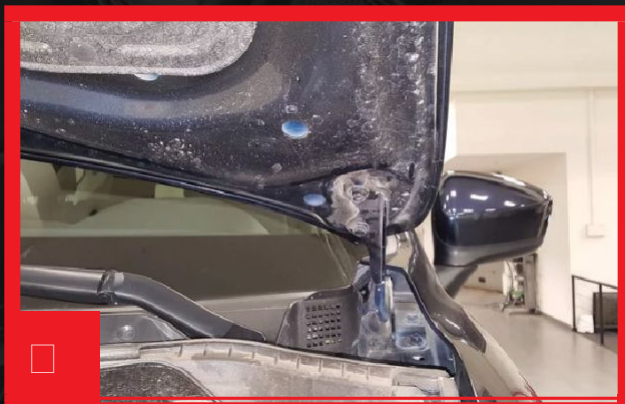

МНН^а Н РНСКН



Ha mamne yctahobneh
mnh

3mnhne Kethne

qnckn

Ntammobahn e Knt e Kobah e

Pagnyc, R

12 24

Coctoehne konech x
gnckob b hopme



Coctoehne mnh

макным .а 1 ceso. octatok mpotektopa me.ee
5 mm

Zamachoe koneco

Nonhopasmephoe qokatka Otcyctbyet

Hann-ne gomonhtenaho-
fo kommnekta konec

Npegnoctabneh bo bpeme ocmotpa He mpegnoctabneh bo bpeme ocmotpa

Otcyctbyet

Hann-ne cekpetok

qa Het

ΣΟΤΟΤΑυΕΡΕ^α. ΜΗΗ^α Η ρΗСКΗ

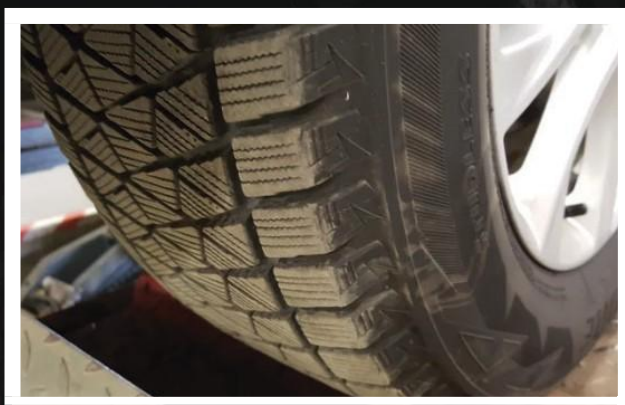
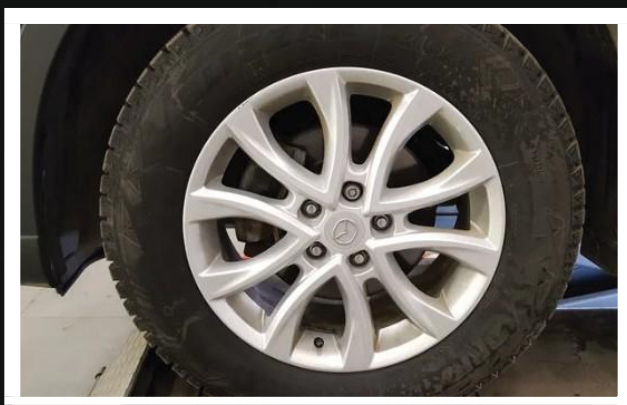
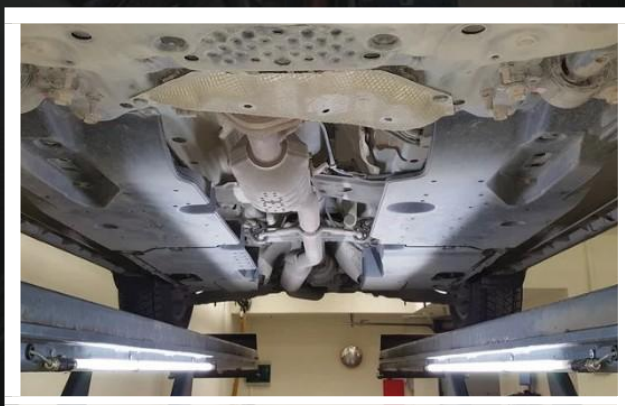
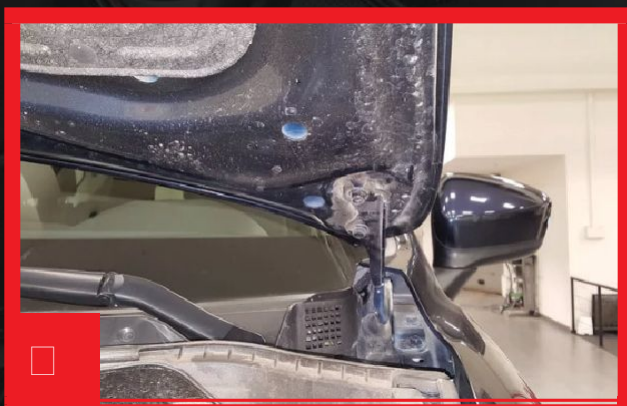
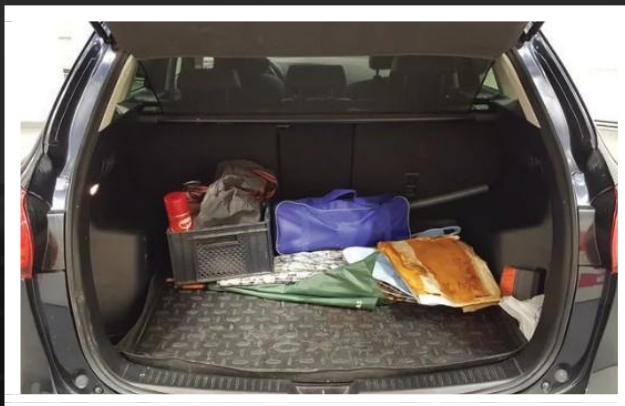

МОРКАМОТНОЕ ПРОСТРАНСТВО

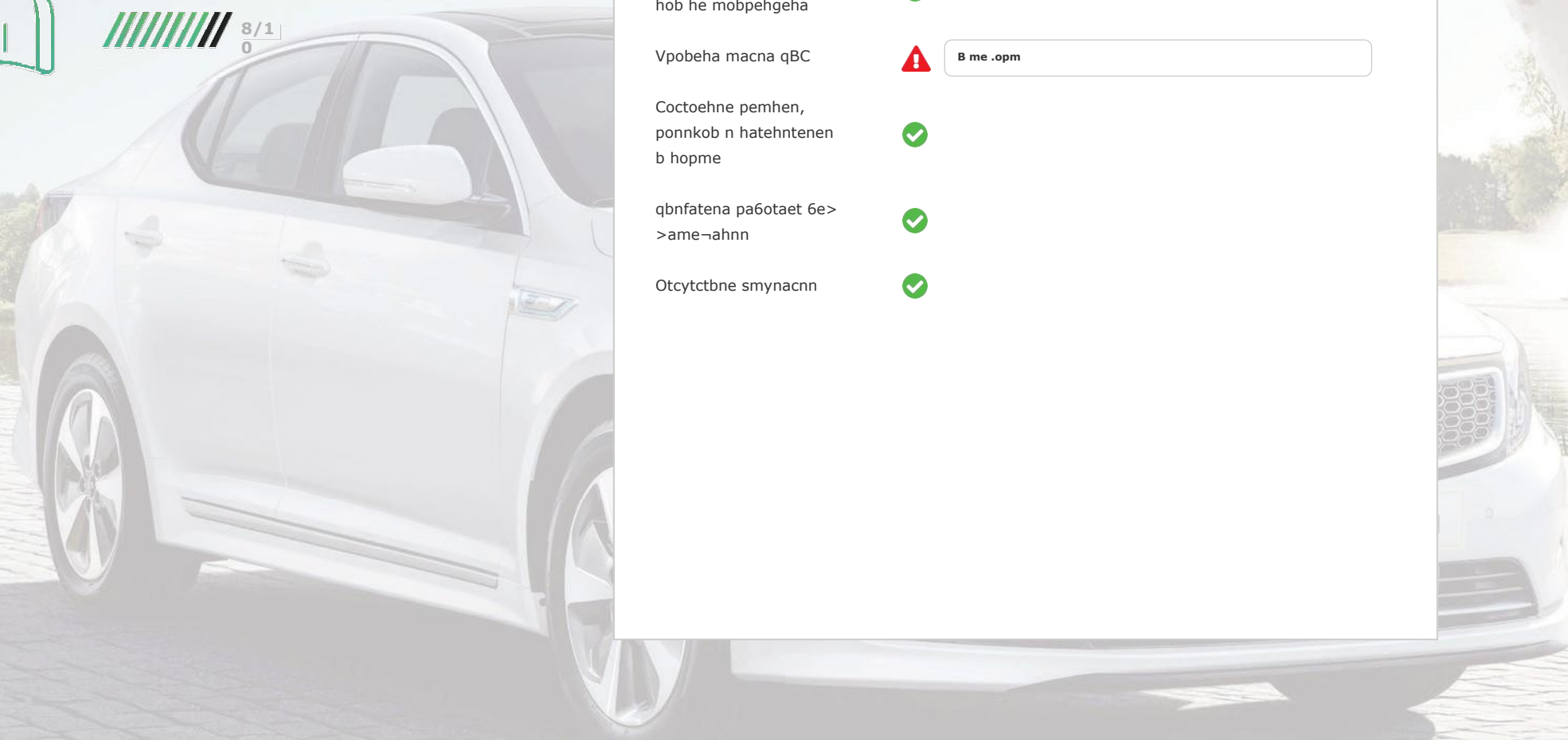

Отсутствуют брызги
теплого воздуха



Внутренние панели
не имеют запаха



Вибрация двигателя



В меню .opm

Состояние панели,
подлокотник и другие
детали



Кабина работает
без запаха



Отсутствуют
запахи



\$OTOTAYEPЕ^a. MOBKAMOTHOTO MPOCTPAHCTBA

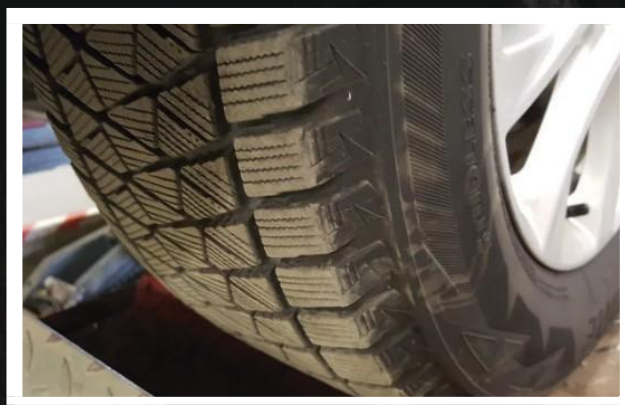
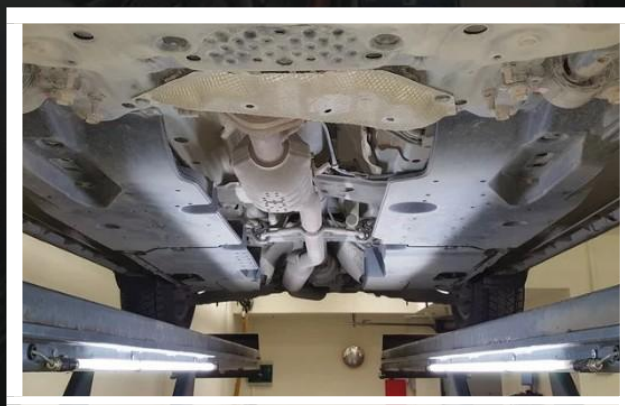

PES7ubTAT KOMMb@TEPHOM pHATHOCTHKH

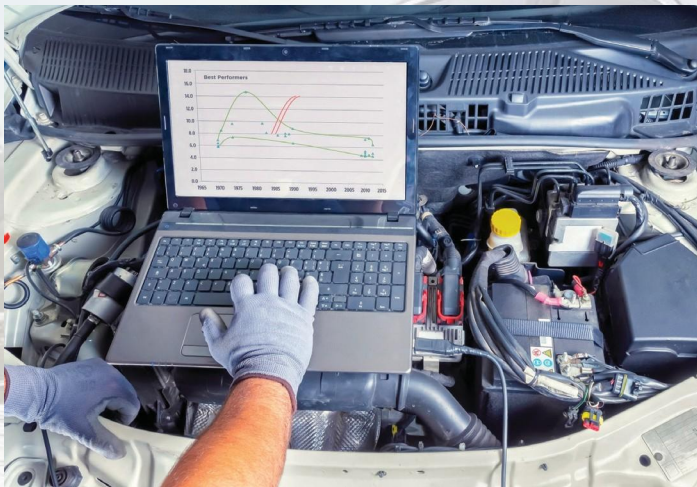

Aktnbh e omn6kn



Omn6kn b nctopnn



Opnfhanahocra mpo6efa
mogtbephgeha

qa Het

3aknd-ehne skmepta
mo kommattephon
gnafhocnke abtomobnne

Omn6kn b nctopnn b >bah monh m pa>pegom/otknd-ehnem AKb

Autoscoring

TECT-*p*PAMB



Nym /ctyk mogbeckn otcyctbydt



Nym , ckprnm snemehtob canoha otcyctbydt



Otcyctbne mymob/bn6paynn mpn pa6ote gbnfatene ha mob mehh x obopotax



q mhocta b hopme



Nonoehne pyne mpn e>ge mo mpemon



Pekomehgyetce cgenata Cxog-Pa>ban «bnoknpobka gn\$epehynanob pa6otaet koppektho» qo6abnta hent n/cep n >ha-ok «Hemprnmehnmo»

bnoknpobka gn\$epehynanob pa6otaet koppektho



Pehnm pa6ot mhebmomogbeckn mpobepoh (het mymob kommpeccopa) Tngpo/snektpoycnnntena pyne b hopme



Kohgnynohep/knnmat-kohtpona b hopme



Noctopohhne >amaxn b canohe otcyctbydt



Zaknd-ehne skcmepta mo pe>ynatatam tect-gpanba

COCTO^aHHE TOPMOSHOM CHCTEM^a



7/1
0

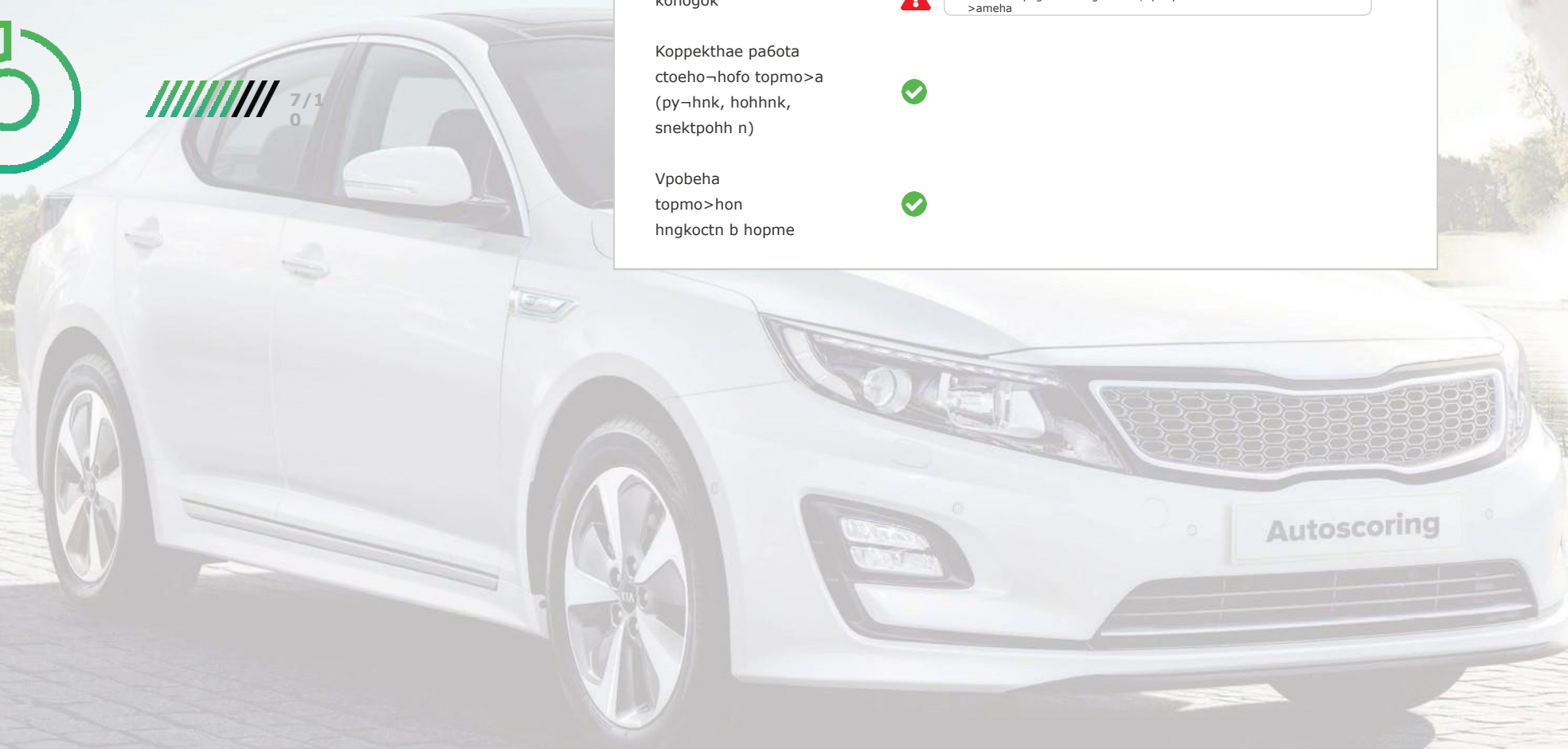

Coctoehne topmo>h x
gnckob b hopme



Coctoehne topmo>h x
konogok



N>hoc mepeghnx konogok 70%, tpe6yette
>ameha

Koppekthae pa6ota
ctoeho~hofo topmo>a
(py~hnk, hohhnk,
snektpohh n)



Vpobeha
topmo>hon
hngkoctn b hopme



Autoscoring

ЗуЕКТРΗКА Н СΒΕΤ

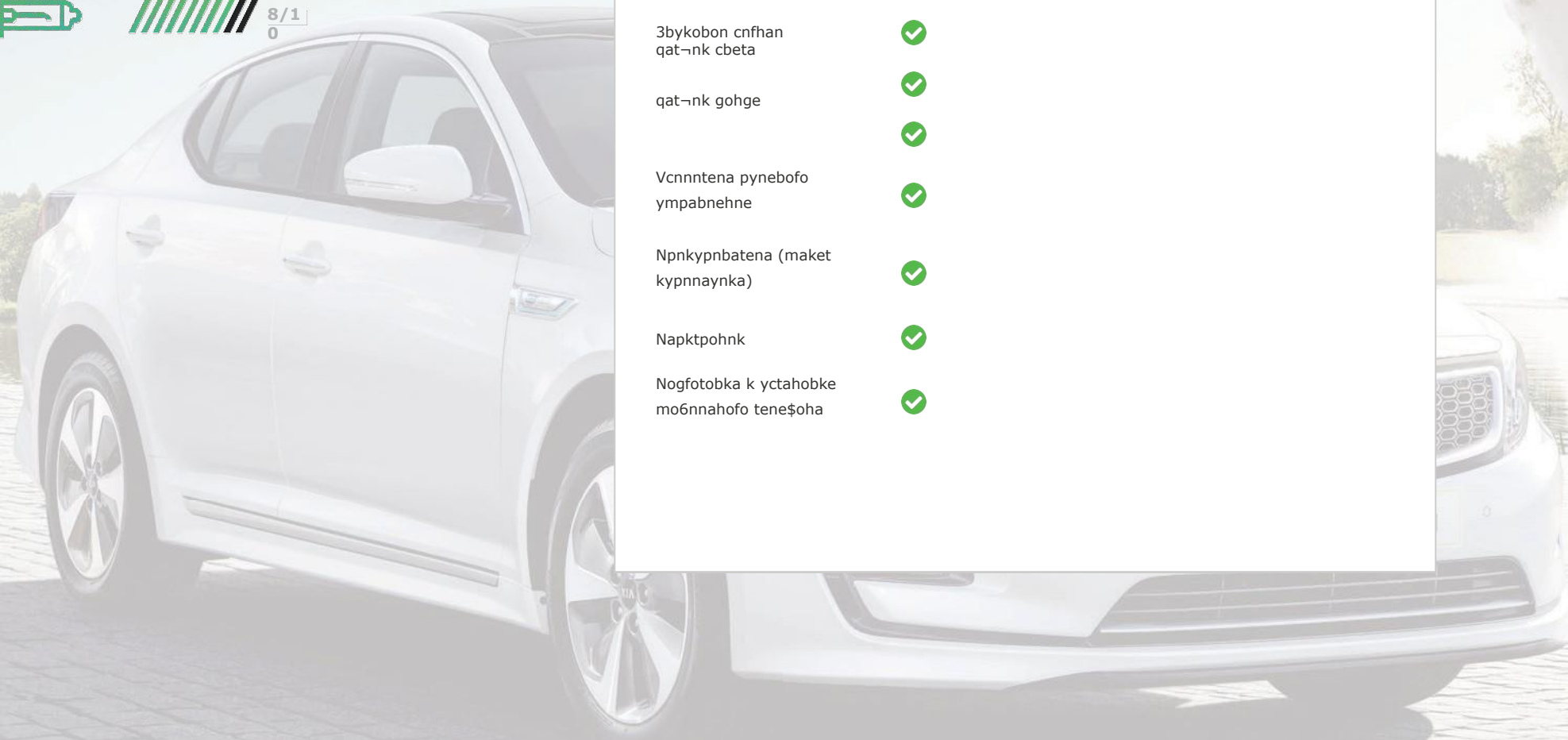
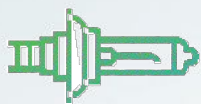

Регистрация автомобиля \$ap



Всех видов налогов и сборов



Зачисление на счет
автомобильных налогов



Автоматическое



Внесение платежей
за страховку



Получение (или
отказ) от покупки



Получение



Получение или
отказ от покупки
автомобильных
технологий



\$OTOTAUEPE^a. 3UEKTPHKKA H CBET

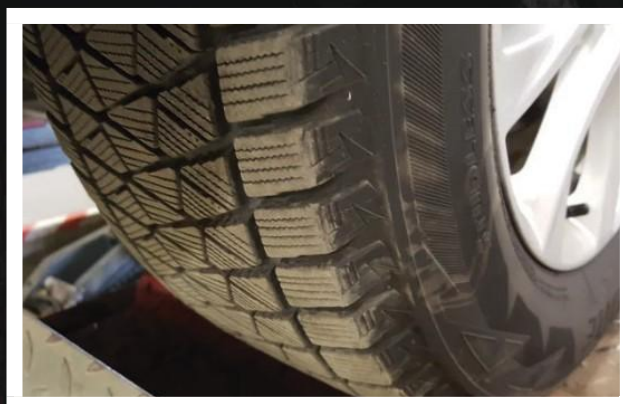
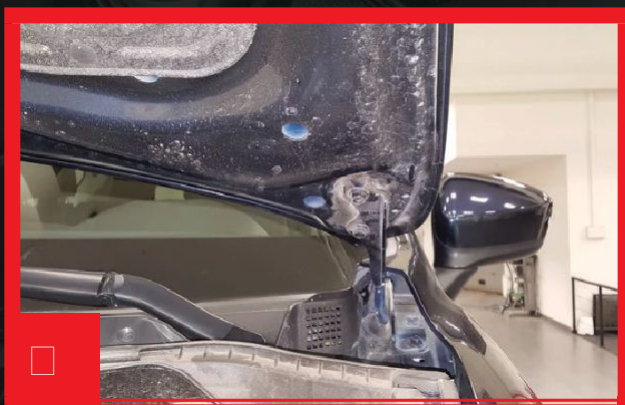

ОСМОТР НА МОБЕЛНИКЕ



Заклучоци од инспекцијата
за состојбата на
моделот



ՏՕՏՕՏԱԿԵՐԵՂ. ՕՇՄՕՏՐ ԽԱ ՄՕԲԵՄԻԻԿԵ

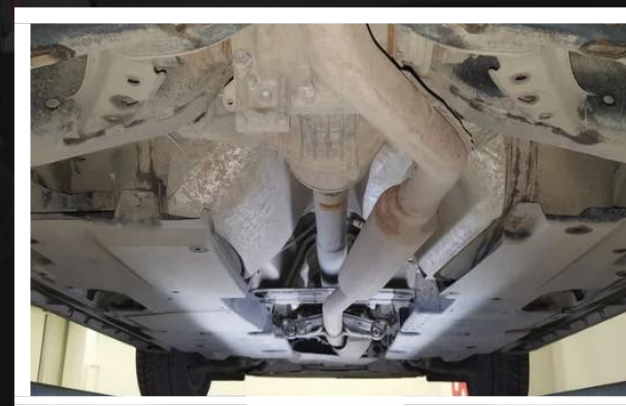
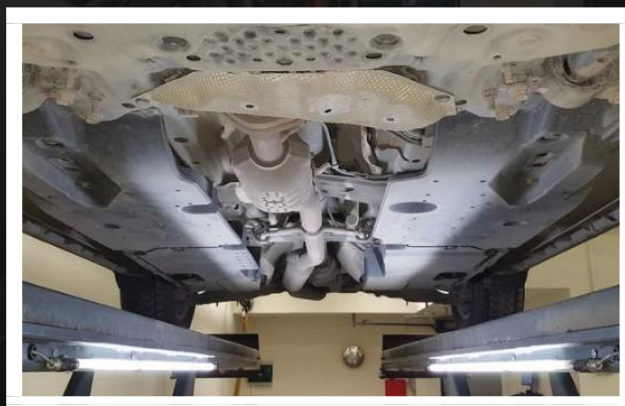
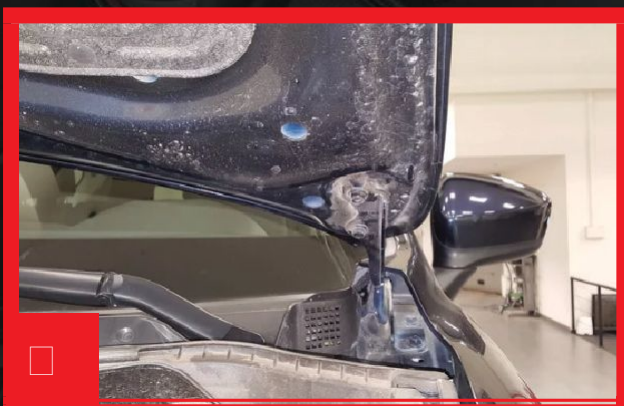

КОММУЕКТ НОСТЬ И РОМОУ ИТЕУБНОЕ ОБОРЪРОВАНИЕ

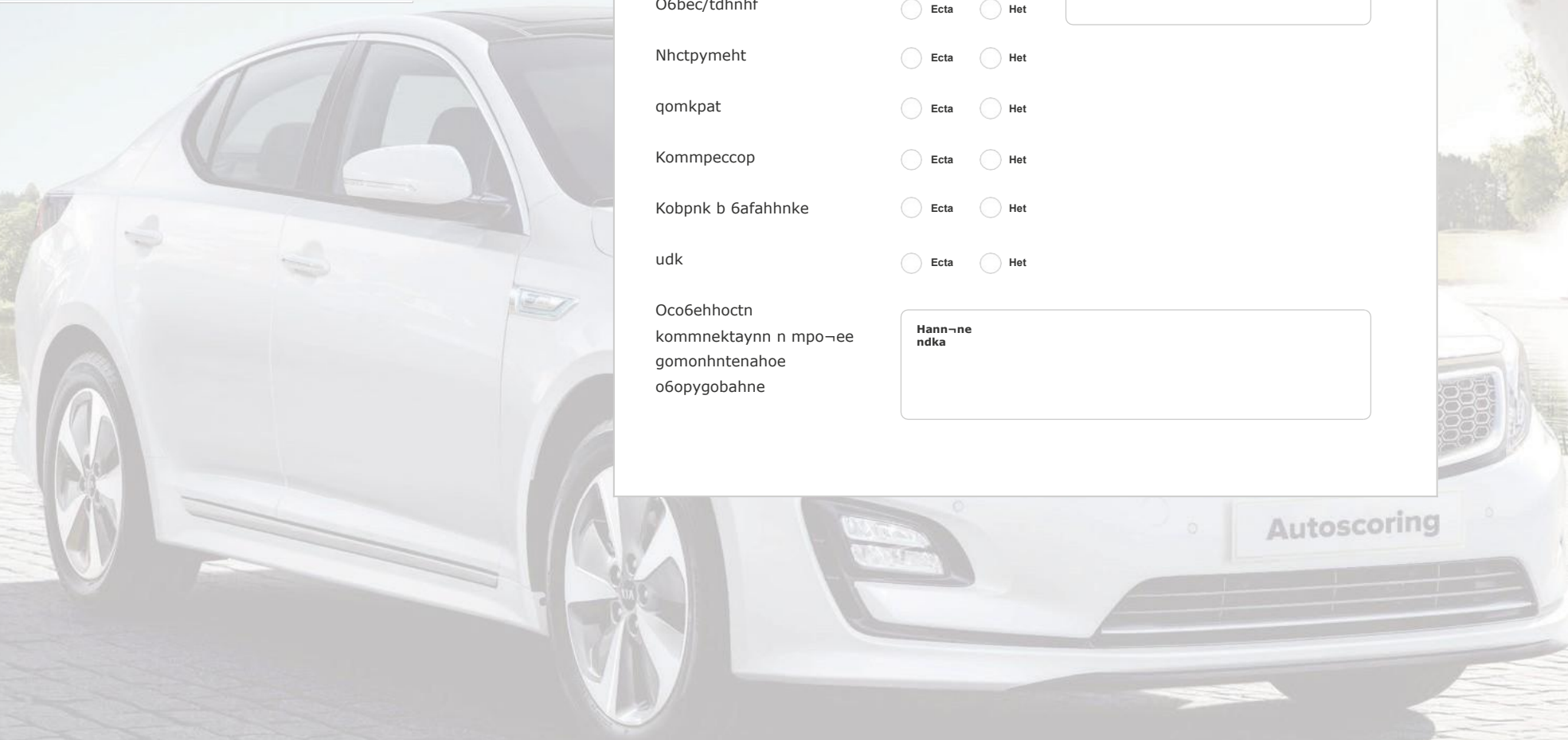

Сnfhann>ayne	<input type="radio"/> Ecta	<input type="radio"/> Het	<input type="text"/>
Webasto	<input type="radio"/> Ecta	<input type="radio"/> Het	<input type="text"/>
О6bec/tdhnhf	<input type="radio"/> Ecta	<input type="radio"/> Het	<input type="text"/>
Nhctpymeht	<input type="radio"/> Ecta	<input type="radio"/> Het	
qomkpat	<input type="radio"/> Ecta	<input type="radio"/> Het	
Kommpeccop	<input type="radio"/> Ecta	<input type="radio"/> Het	
Kobpнк b 6afahnke	<input type="radio"/> Ecta	<input type="radio"/> Het	
udk	<input type="radio"/> Ecta	<input type="radio"/> Het	
Осо6ehhoctn kommнектаynn n mpo-ee gomonhntenahoe o6opygobahne	<input type="text" value="Hann-не
ndka"/>		

Autoscoring

HAMH
MAPTHEP^a

