

1 금 5 과





В этом уроке вы узнаете:

1. Китайские числительные
2. Как назвать дату и день недели
3. Прошедшее время в корейском языке
4. Соединение глаголов в предложении

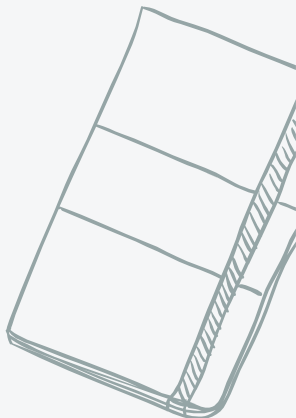

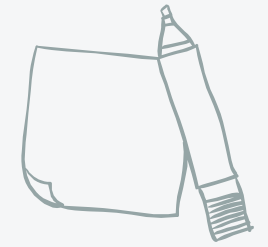

Китайские числительные

1	2	3	4	5	6	7	8	9	10
일	이	삼	사	오	육	칠	팔	구	십

*ДНИ, МЕСЯЦЫ, ГОДЫ, ДЕНЬГИ

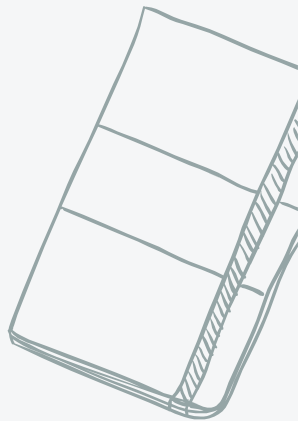

Дни недели и показатели времени

- ✓ 일요일 "воскресенье" (일 (日) – солнце)
- ✓ 월요일 "понедельник" (월 (月) – луна)
- ✓ 화요일 "вторник" (화 (火) – огонь)
- ✓ 수요일 "среда" (수 (水) – вода)
- ✓ 목요일 "четверг" (목 (木) – дерево)
- ✓ 금요일 "пятница" (금 (金) – металл)
- ✓ 토요일 "суббота" (토 (土) – земля)



주말

выходной

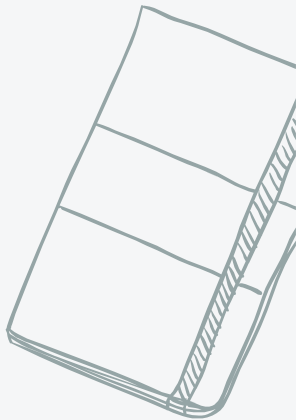
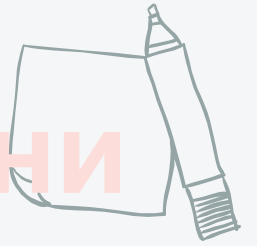



Дни недели и показатели времени.

Вопрос:

1)

-오늘은 무슨 요일이에요? / 오늘은 무슨
요일입니까?

-금요일이에요. / 금요일입니다.

2)

-오늘은 목요일이에요?

-아니요, 수요일이에요.

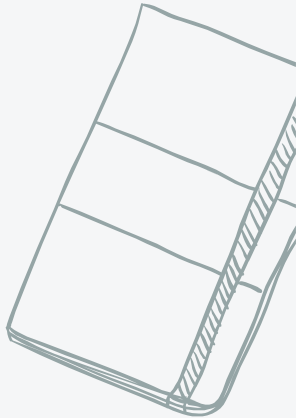



Дни недели и показатели времени.

Вопрос:

1)

-오늘은 무슨 요일이에요? / 오늘은 무슨
요일입니까?

-금요일이에요. / 금요일입니다.

2)

-오늘은 목요일이에요?

-아니요, 수요일이에요.

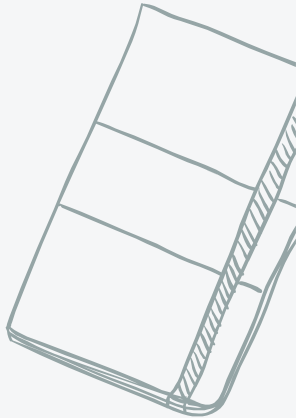



Месяца

1월	2월	3월	4월	5월	6월	7월	8월	9월	10월	11월	12월
일월	이월	삼월	사월	오월	유월	칠월	팔월	구월	시월	십일월	십이월

-오늘은 몇일입니까?

-구월 (9월) 오일 (5일) 입니다.

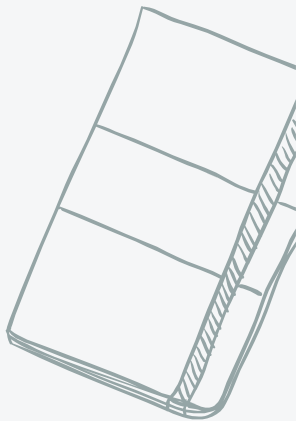

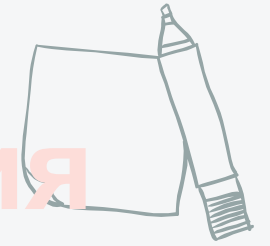

Как спросить про день рождения

연습1 친구와 이야기해 보세요. Find out your classmates' birthdays.



생일이 며칠이에요?

생일이 언제예요?

3월 23일이에요.



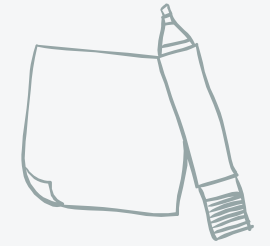

N에 – временной падежный показатель «В»



- 1)
 - 토요일에 무엇을 해요?
 - 친구하고 영화를 봐요.



2) 새해에 친구하고 파티를 해요.

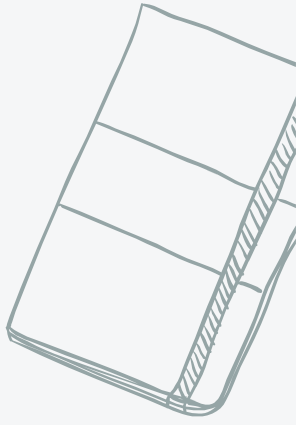

보기



목요일

목요일에 뭐 해요?

목요일에는 태권도를 배워요.

1)



화요일

2)



금요일

3)



주말

4)



생일

5)



크리스마스

6)

?



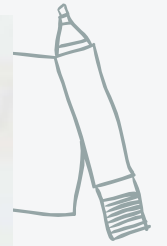
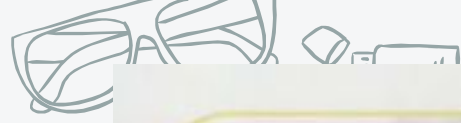

민 수 5월 9일에 시간이 있어요?

아키라 9일이 무슨 요일이에요?

민 수 금요일이에요. 금요일에 파티가 있어요.

아키라 아, 미안해요. 금요일에는 약속이 있어요.
친구하고 같이 영화를 봐요.



약속이
[약쓰기]

같이
[가치]

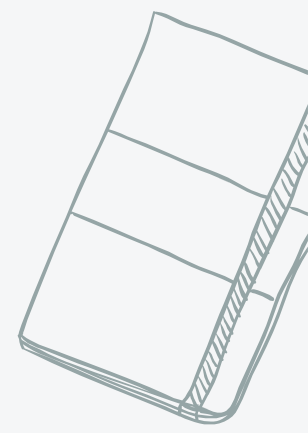



민 수 5월 9일에 시간이 있어요?
 아키라 9일이 무슨 요일이에요?
 민 수 금요일이에요. 금요일에 파티가 있어요.
 아키라 아, 미안해요. 금요일에는 약속이 있어요.
 친구하고 같이 영화를 봐요.

 약속이
 [약속기]
 같이
 [가치]

연습1 친구와 연습해 보세요.
 Practice with your partner.

- | | | | |
|---------------------------|--------------------------|------------------------------|------------------------------|
| 1) 5월 9일
금요일
영화를 보다 | 2) 6월 20일
월요일
쇼핑하다 | 3) 11월 17일
토요일
도서관에 가다 | 4) 10월 13일
화요일
미용실에 가다 |
|---------------------------|--------------------------|------------------------------|------------------------------|





V았/었 – прошедшее время

1)

- 어제 무엇을 했어요? 했습니까?
- 백화점에 갔어요/ 갔습니다.

2)공원에서 운동했어요.

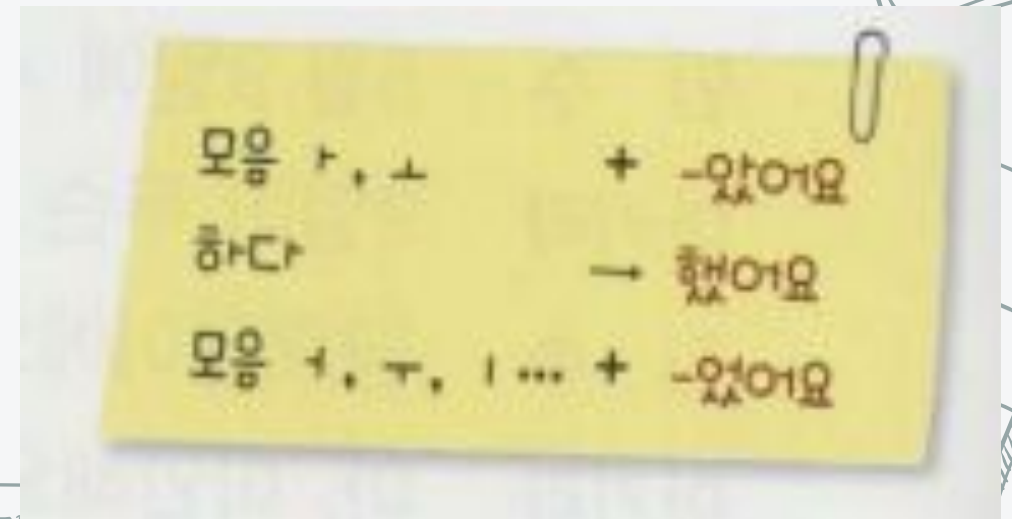

보기



도서관

어제 뭐 했어요?

도서관에 갔어요.
도서관에서 책을 읽었어요.

1)



인사동

2)



코엑스몰

3)



강남역

4)

?

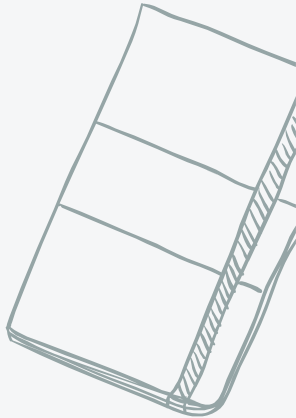
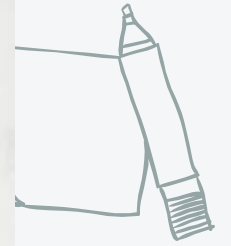

Word Stem Ends in ㅏ or ㅑ	Word Stem Ends in Vowel Other than ㅏ or ㅑ	Word Ends in 하다
앉다 + -았어요 → 앉았어요	먹다 + -었어요 → 먹었어요	공부 하다 → 공부했어요

Base Form	-았어요	Base Form	-었어요	Base Form	했어요
보다	봤어요	씻다	씻었어요	청소하다	청소했어요
만나다	만났어요	*쓰다	썼어요	입학하다	입학했어요
달다	달았어요	있다	있었어요	운동하다	운동했어요
팔다	팔았어요	열다	열었어요	요리하다	요리했어요
잡다	잡았어요	*줍다	주웠어요	숙제하다	숙제했어요
*모르다	몰랐어요	*부르다	불렀어요	게임하다	게임했어요

이다	Vowel Ending	-였어요	간호사였어요
	Consonant Ending	-이었어요	학생이었어요
아니다	Vowel Ending	가 아니었어요	간호사가 아니었어요
	Consonant Ending	이 아니었어요	학생이 아니었어요

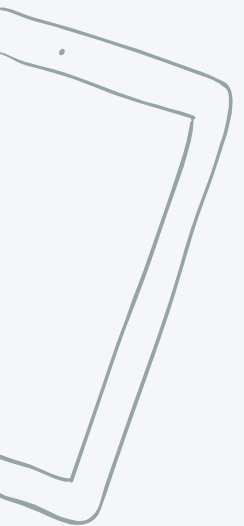
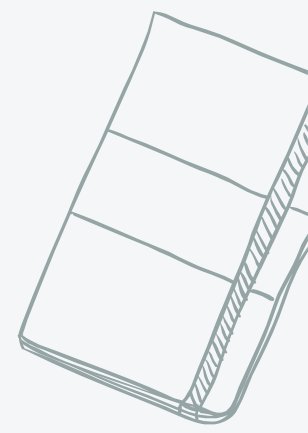
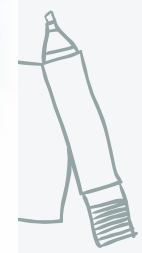

- 12월 7일: (1) 친구를 _____.
- (2) 피자를 _____.
- (3) 피자가 _____.

- 12월 8일: (4) 백화점에 _____.
- (5) 구두를 _____.
- (6) 구두가 _____.

• 12월 9일: (7) 머리가 _____, 병원에 갔어요.

• 12월 10일: (8) 노래를 _____.

• 12월 11일: (9) _____.

- 12월 12일: (10) 영화를 _____.
- (11) 영화가 _____.

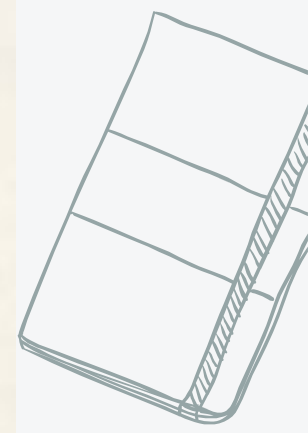
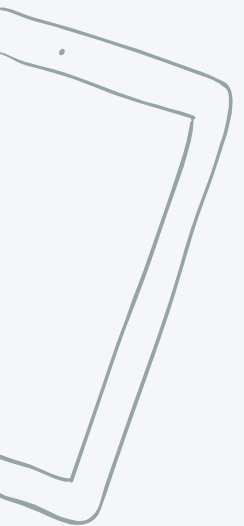

V고 – соединительная конструкция

2. V-고 track 54



A 주말에 뭐 했어요?
B 친구하고 같이 영화 보고 쇼핑했어요.

예

- 숙제를 하고 텔레비전을 봐요.
- 밥을 먹고 차를 마셨어요.

가: 주말에 뭐 했어요?

나: 친구하고 같이 영화를 보고 쇼핑했어요.



줄리앙 주말에 뭐 했어요?

마리코 코엑스몰에 갔어요.

줄리앙 거기에서 뭐 했어요?

마리코 친구하고 같이 영화를 보고 쇼핑했어요.

줄리앙 씨는 뭐 했어요?

줄리앙 저는 집에서 쉬었어요.

줄리앙 주말에 뭐 했어요?

마리코 코엑스몰에 갔어요.

줄리앙 거기에서 뭐 했어요?

마리코 친구하고 같이 영화를 보고 쇼핑했어요.

줄리앙 씨는 뭐 했어요?

줄리앙 저는 집에서 쉬었어요.

연습1 친구와 연습해 보세요. Practice with your partner.

1) 주말

코엑스몰

영화를 보다
/ 쇼핑하다

2) 금요일

인사동

구경하다
/ 차를 마시다

3) 생일

강남역

밥을 먹다
/ 노래방에 가다

4) 어제

공원

산책하다
/ 사진을 찍다



Аудирование (учебник)



듣기1 잘 듣고 날짜를 표시하세요. track 56
Listen carefully and check the dates.

(6)월

1)

일	월	화	수	목	금	토
	1	2	3	4	5	6
7	8	9	10	11	12	13
14	15	16	17	18	19	20
21	22	23	24	25	26	27
28	29	30	31			

()월

2)

일	월	화	수	목	금	토
			1	2	3	4
5	6	7	8	9	10	11
12	13	14	15	16	17	18
19	20	21	22	23	24	25
26	27	28	29	30	31	

()월

3)

일	월	화	수	목	금	토
				1	2	3
4	5	6	7	8	9	10
11	12	13	14	15	16	17
18	19	20	21	22	23	24
25	26	27	28	29	30	31

()월

4)

일	월	화	수	목	금	토
			1	2	3	4
6	7	8	9	10	11	12
13	14	15	16	17	18	19
20	21	22	23	24	25	26
27	28	29	30	31		

()월

5)

일	월	화	수	목	금	토
1	2	3	4	5	6	7
8	9	10	11	12	13	14
15	16	17	18	19	20	21
22	23	24	25	26	27	28
29	30	31				

()월

6)

일	월	화	수	목	금	토
						1
						2
3	4	5	6	7	8	9
10	11	12	13	14	15	16
17	18	19	20	21	22	23
24/31	25	26	27	28	29	30

읽기

스티븐의 일기를 읽고 질문에 답하세요.

Read Steven's journal entry and answer the following questions.

11월 10일 토요일

오늘은 토요일이에요. 학교에 안 가요. 그래서 강남역에서 아키라 씨하고 미유키 씨를 만났어요. 미유키 씨는 아키라 씨 여자 친구예요. 어제 한국에 왔어요.

우리는 식당에서 한국 음식을 먹었어요. 밥을 먹고 백화점에 갔어요. 내일은 아키라 씨 생일이에요. 그래서 나는 백화점에서 모자를 샀어요. 모자는 아키라 씨 생일 선물이에요. 우리는 내일 아키라 씨 집에서 생일 파티를 해요.

1) 스티븐은 오늘 어디에 갔어요? 모두 고르세요.

①



②



③



④



⑤



⑥



2) 미유키는 언제 한국에 왔어요?

① 11월 9일

② 11월 10일

③ 11월 11일

3) 아키라의 생일은 무슨 요일이에요?

① 금요일

② 토요일

③ 일요일



Типы календарей в Корее

양력 - солнечный календарь
 음력 - лунный календарь

준비

한국에는 양력과 음력이 있어요. 여러분 나라에도 음력이 있어요?
 Koreans use both the solar and lunar calendars. Do people in your country also use the lunar calendar?

						1 JANUARY
Sunday	Monday	Tuesday	Wednesday	Thursday	Friday	Saturday
1	2	3 _{12.10}	4	5	6	7
8 _{12.15}	9	10	11	12	13 _{12.20}	14
15	16	17	18 _{12.25}	19	20	21
22 _{12.29}	23 _{설날 1.1}	24	25	26	27 _{1.5}	28
29	30	31				

양력

음력





알아
보기

1) 음력 1월 1일은 설날이에요. 설날에는 세배를 하고 떡국을 먹어요.

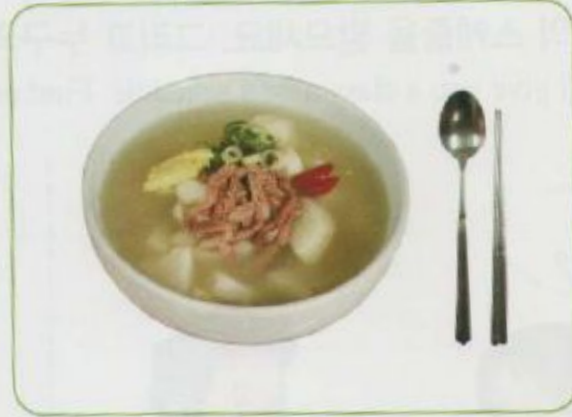

2) 음력 8월 15일은 추석이에요. 추석에는 차례를 지내고 송편을 먹어요.



설날 – лунный **новый**
год

세배 - поклон

떡국 – суп из рисовых
клёцок

추석 – праздник
осеннего равноденствия
/ праздник поклонения
духам предков

차례 – обряд понимания
송편 – рисовый пирожок

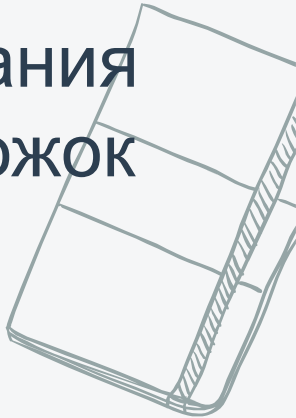



수고하셨습니다!

