



Включили камеру?



Занятие 3

0 уровень



С

возвращением!





Проверяем явки





Правила

П Р А В И Л А

- Соблюдаем тишину, когда кто-то из нас высказывается
- Задаем вопросы, если непонятно, ничего не стесняемся
- К выданным наборам относимся уважительно, детали не бросаем, не передаем друг другу.

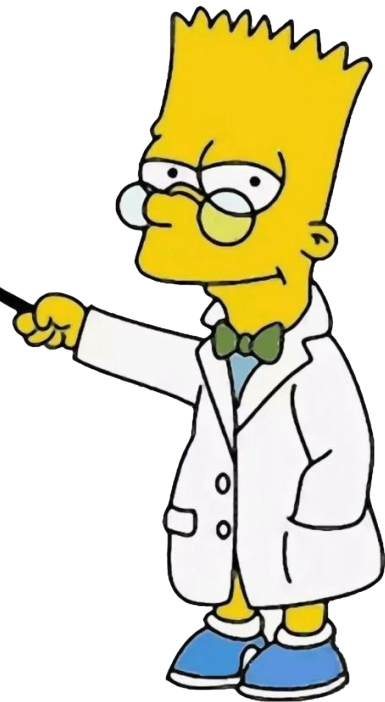

Наши герои





А вы помните...

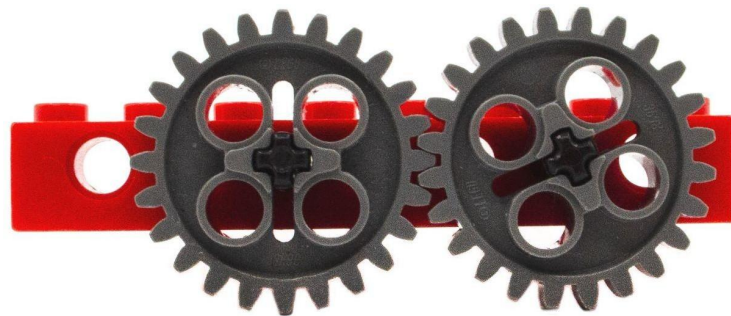
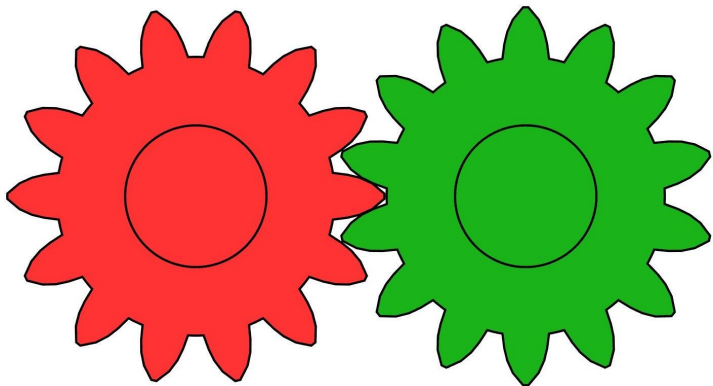



Вспоминаем

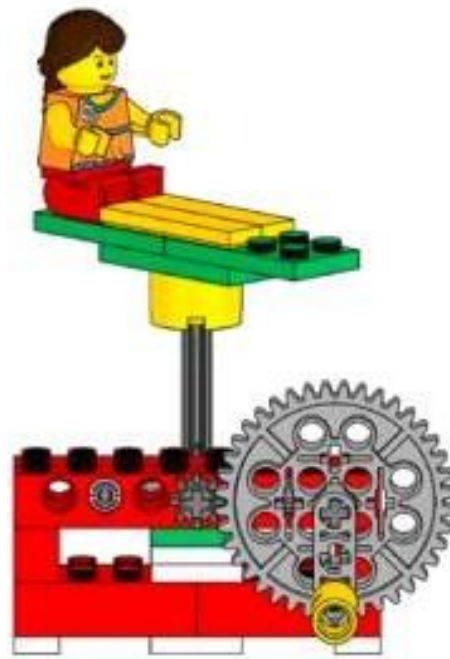
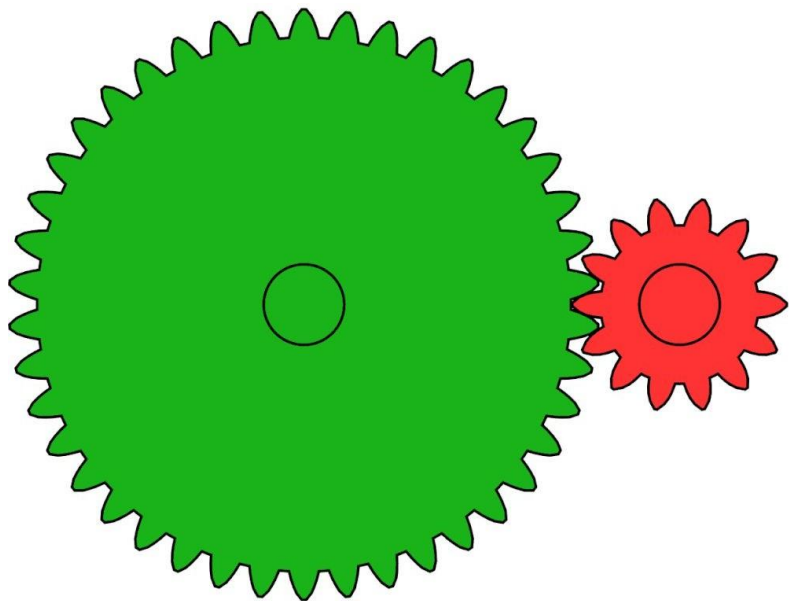



Попрактикуемся

1 команда

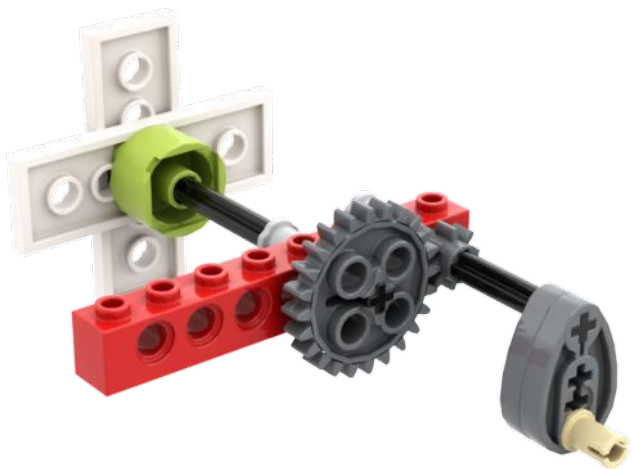

2 команда

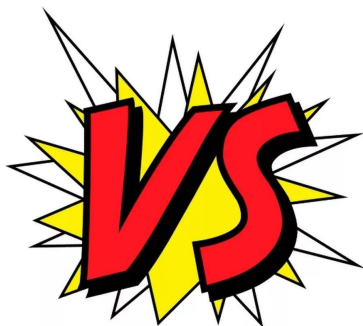
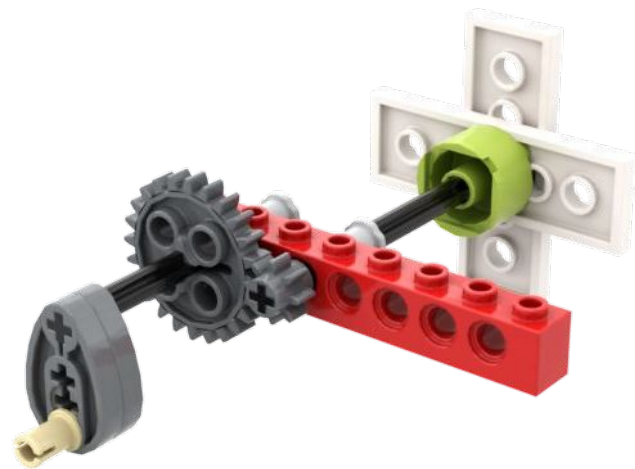



Понижающая передача

ВЕДУЩАЯ

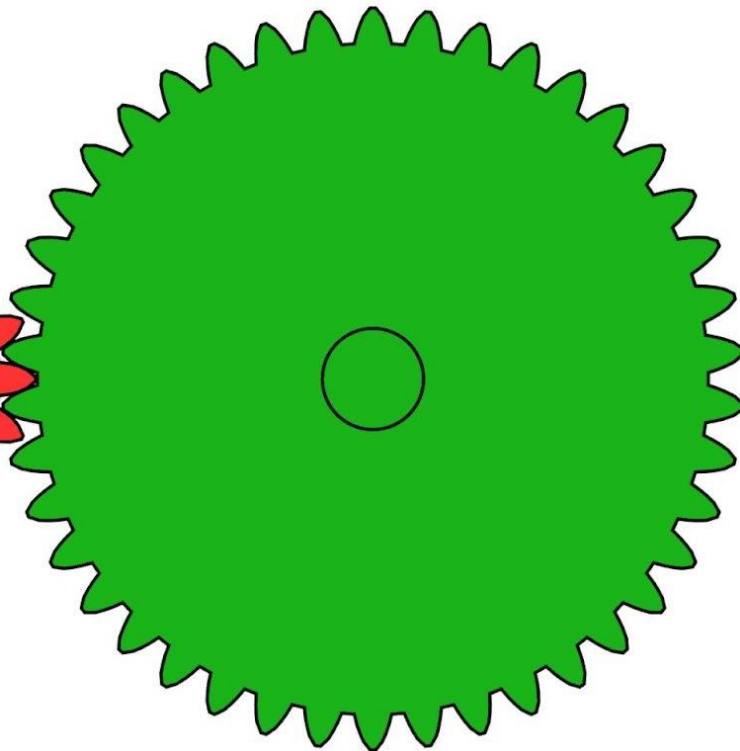
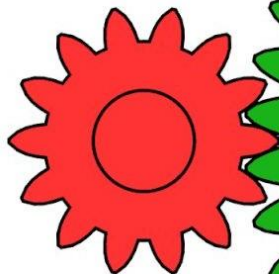
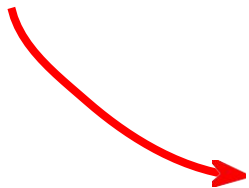

ВЕДОМАЯ

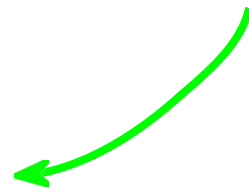



Сила





Сила





Внедорожник





Узнали?





Помогите найти ОТЛИЧИЯ





У вас
получилось!

РОБОТЫ -
помощники

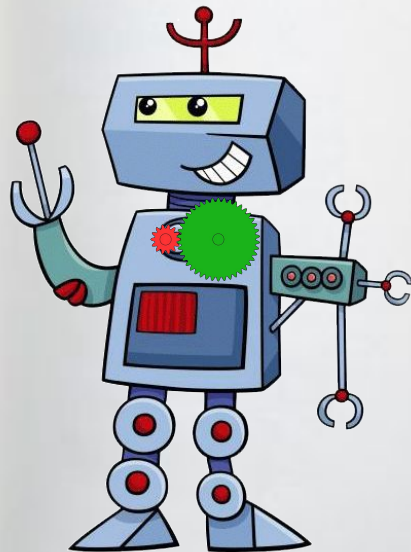
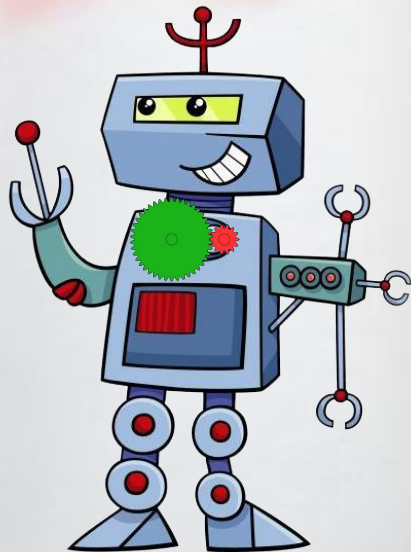



Восстановим энергию





Энергия МЕХАНИЗМОВ





Энергия

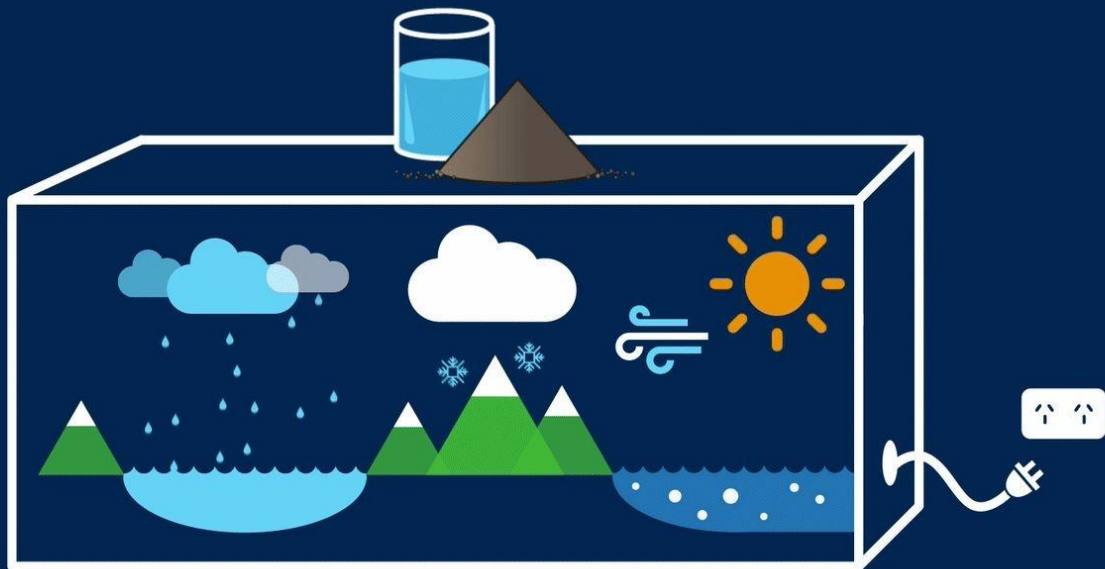



Что ест машина?

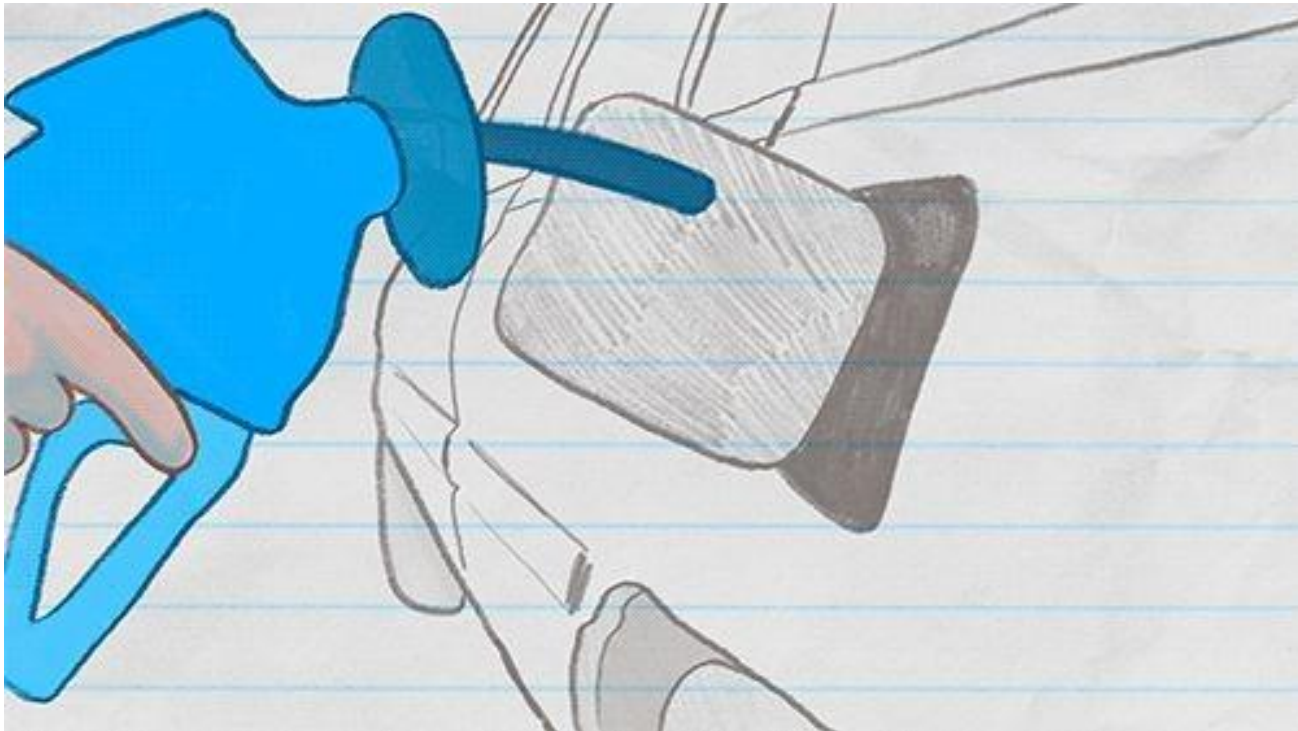



Что ест поезд?





Что ест электropоезд?





Покорители космоса





MKC

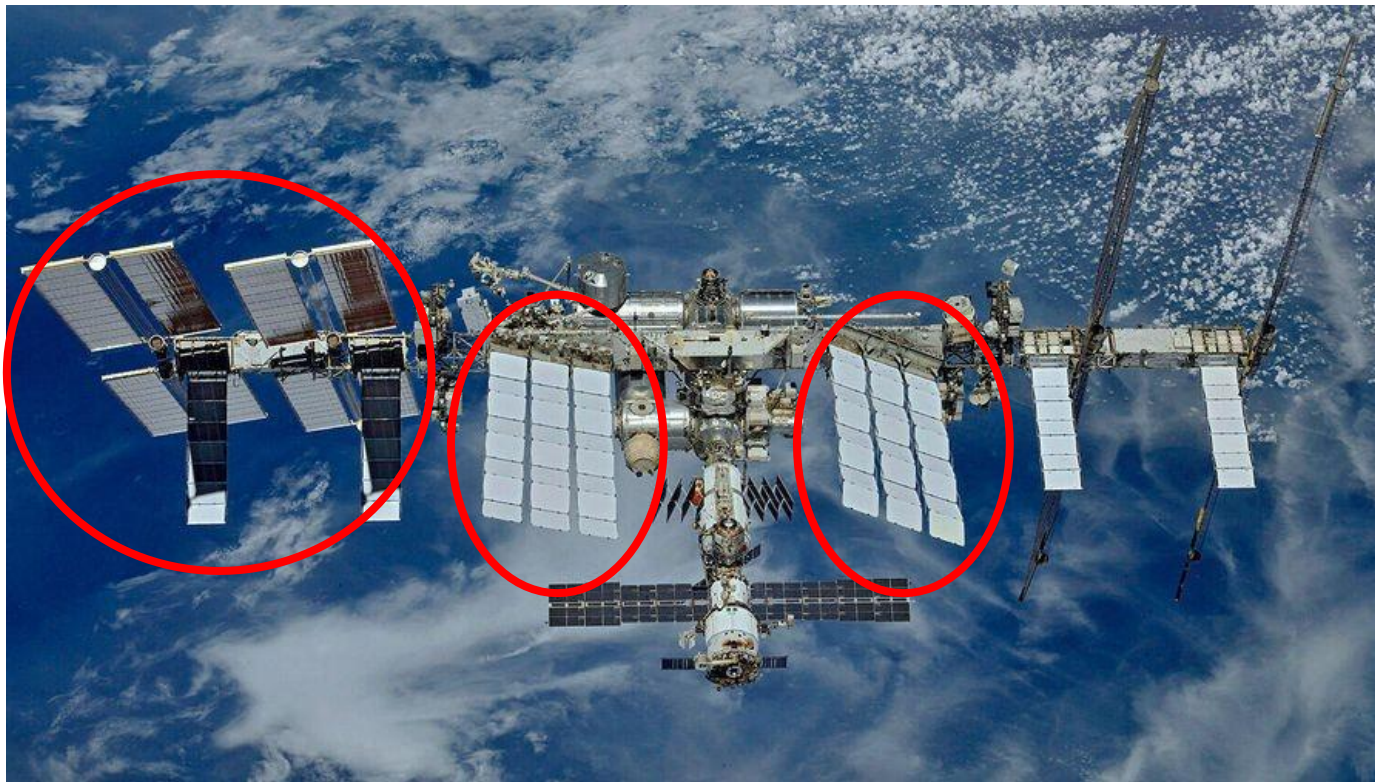



Солнечные батареи





В небе





На земле





Топливо для растений





Солнце





Физминутка





Энергия Вилли закончилась!

Энергия

Двигатель
топливо
бензин

Гаровая
Электростанция

Солнечная
Батарея

The illustration shows an open notebook with a white background. At the top, the word "Энергия" is written in large, bold, black Cyrillic letters, flanked by two red lightning bolts. Below the title, there are four energy sources: a blue sports car, a red steam train, a solar panel, and a glowing yellow robot. To the right of the car is a battery icon with a red bar indicating a full charge. A cartoon boy with brown hair, wearing a blue and yellow striped shirt and blue shorts, stands next to the robot, pointing at it with a concerned expression. The background of the notebook pages is filled with faint, illegible text.



Перерыв





Вспомним пару деталей

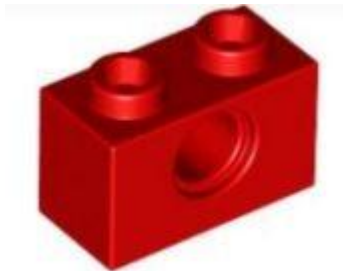

Кирпичная балка на
2 модуля



Желтый кирпич
2 на 4 модуля



Вспомним пару деталей



Фиксатор



Белая пластина
1 на 4 модуля



Узнаем новые



Штифт



Обратный склон
1 на 2 модуля



Гладкий
полукрестовой
штифт



Подумай

Поразмышляем

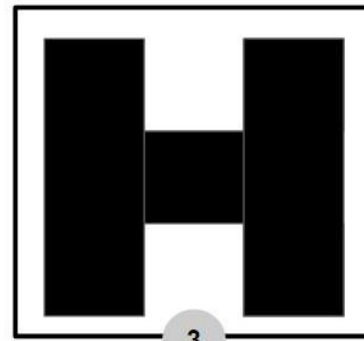
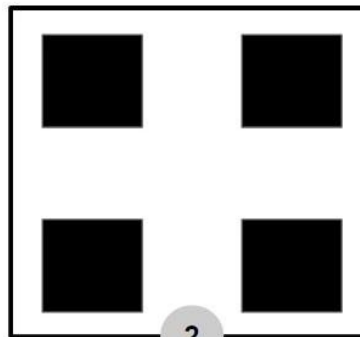
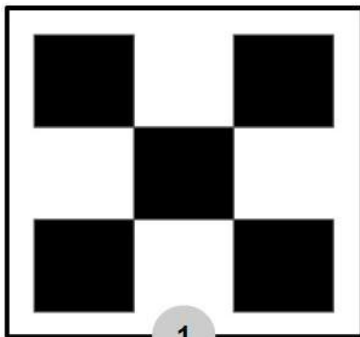
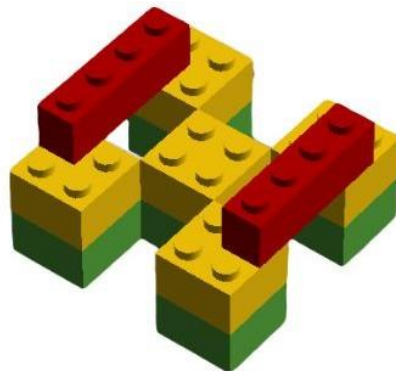

Подумай

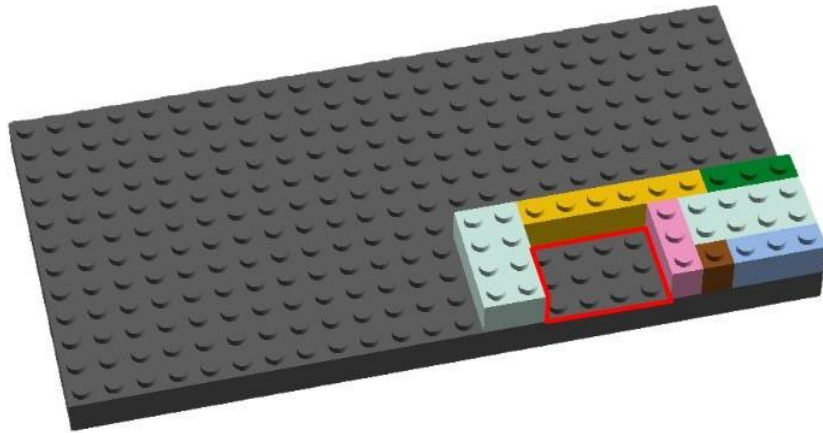

А)

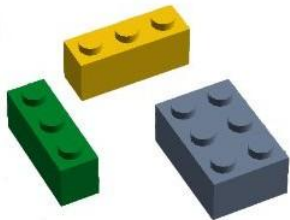

Б)

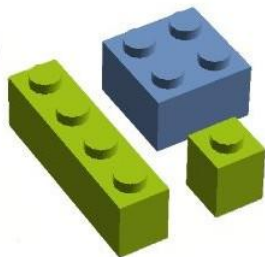

В)

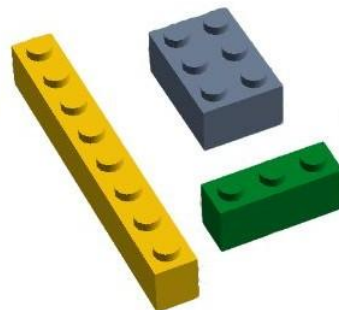

001

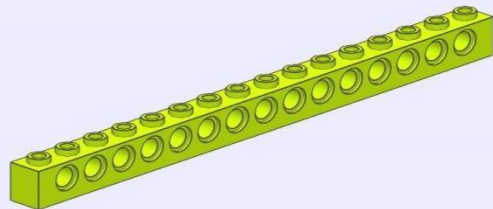

 x4

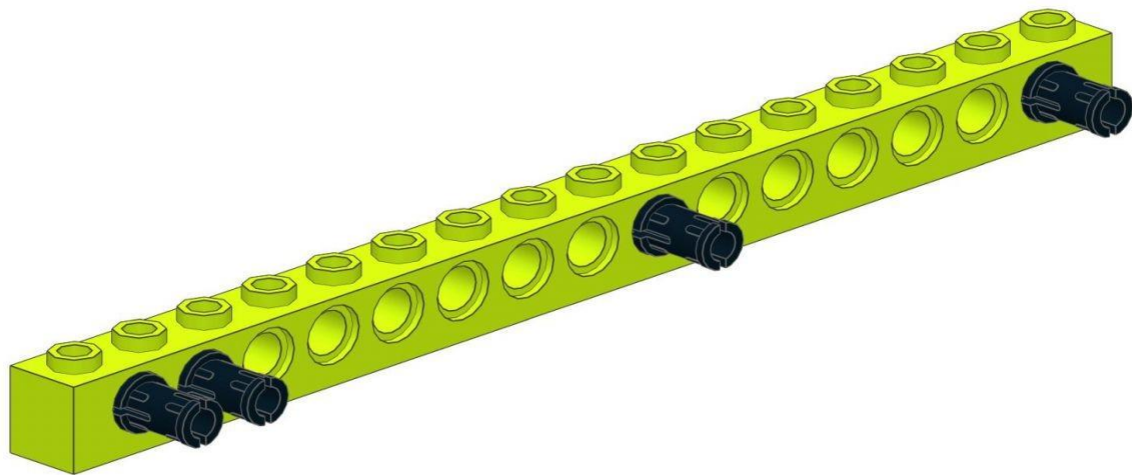

002

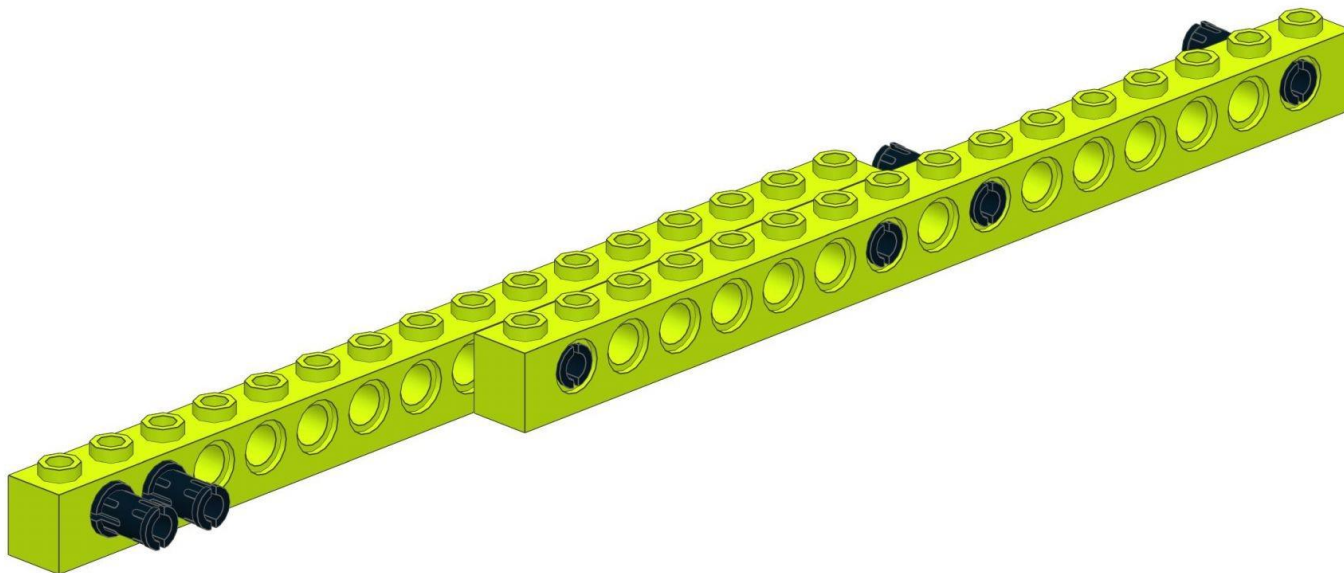
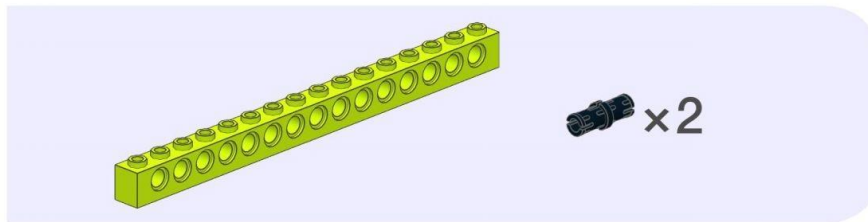

003

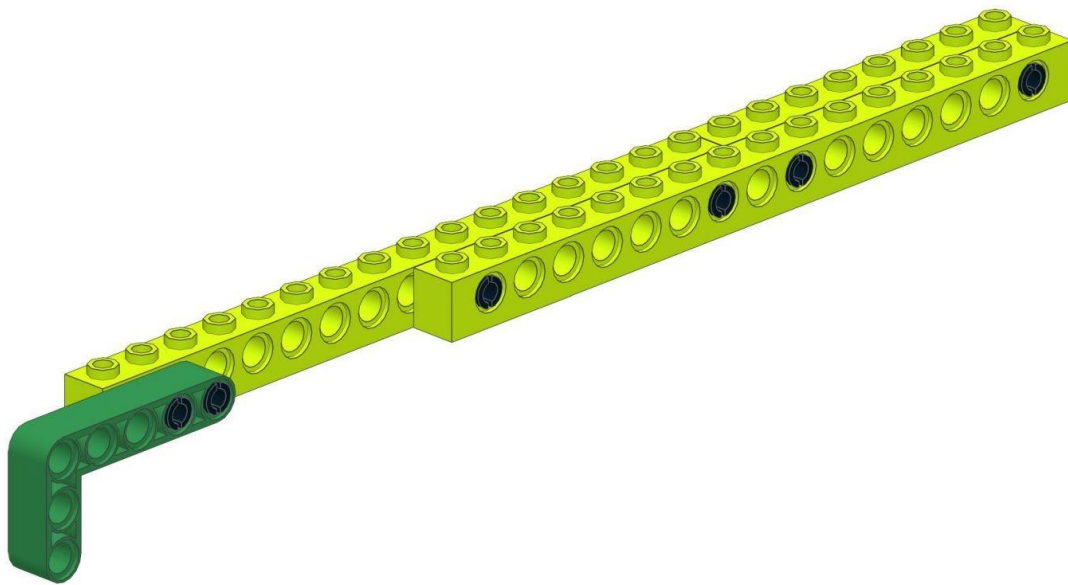
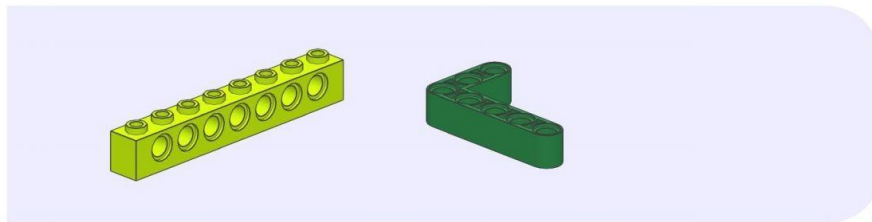

004

 x2

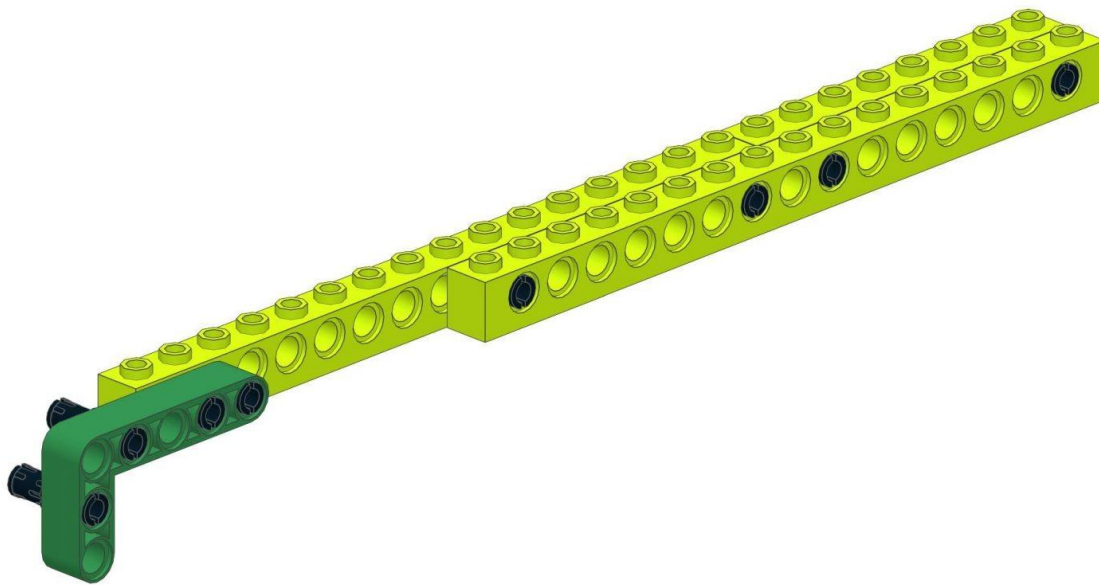

005



006

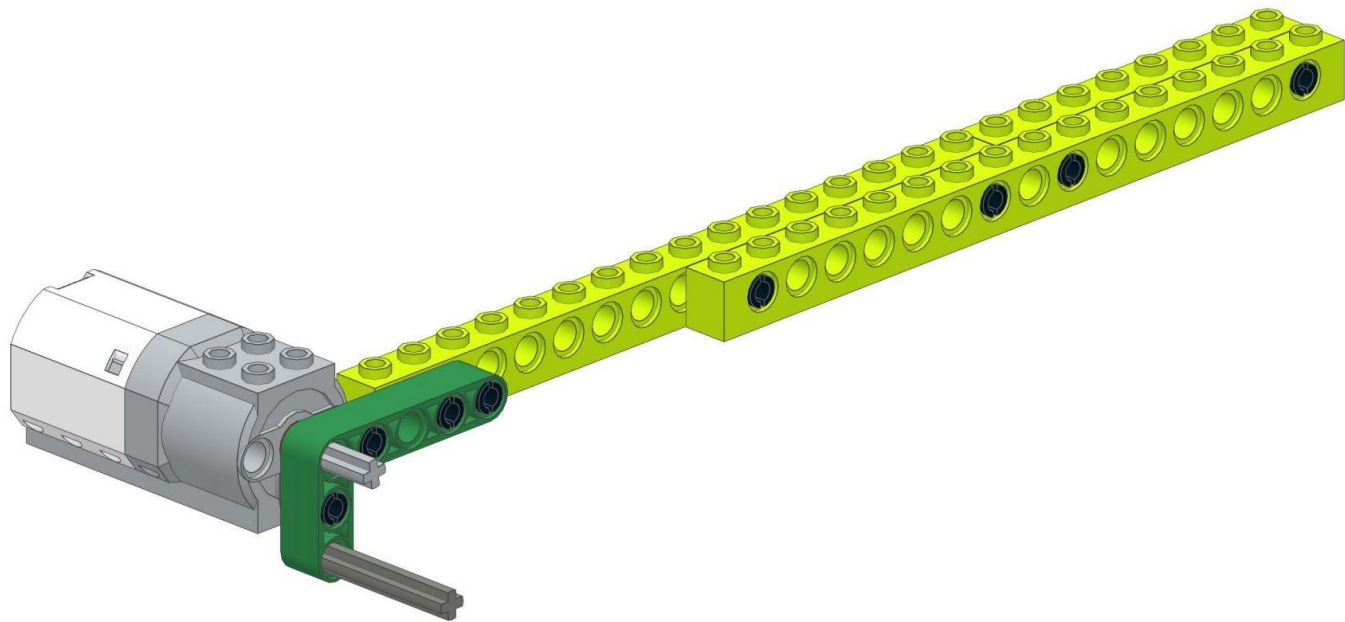
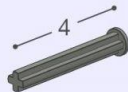
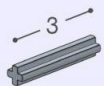

007

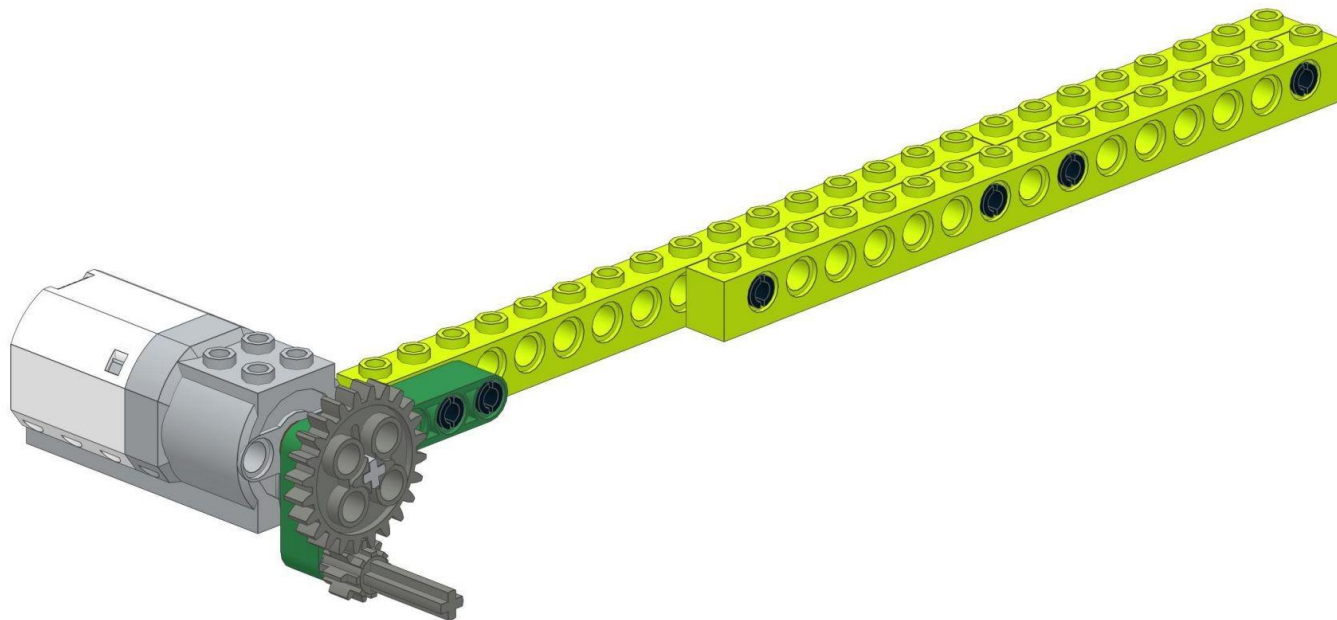
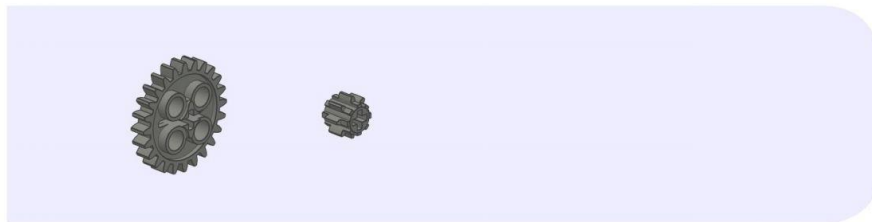

008

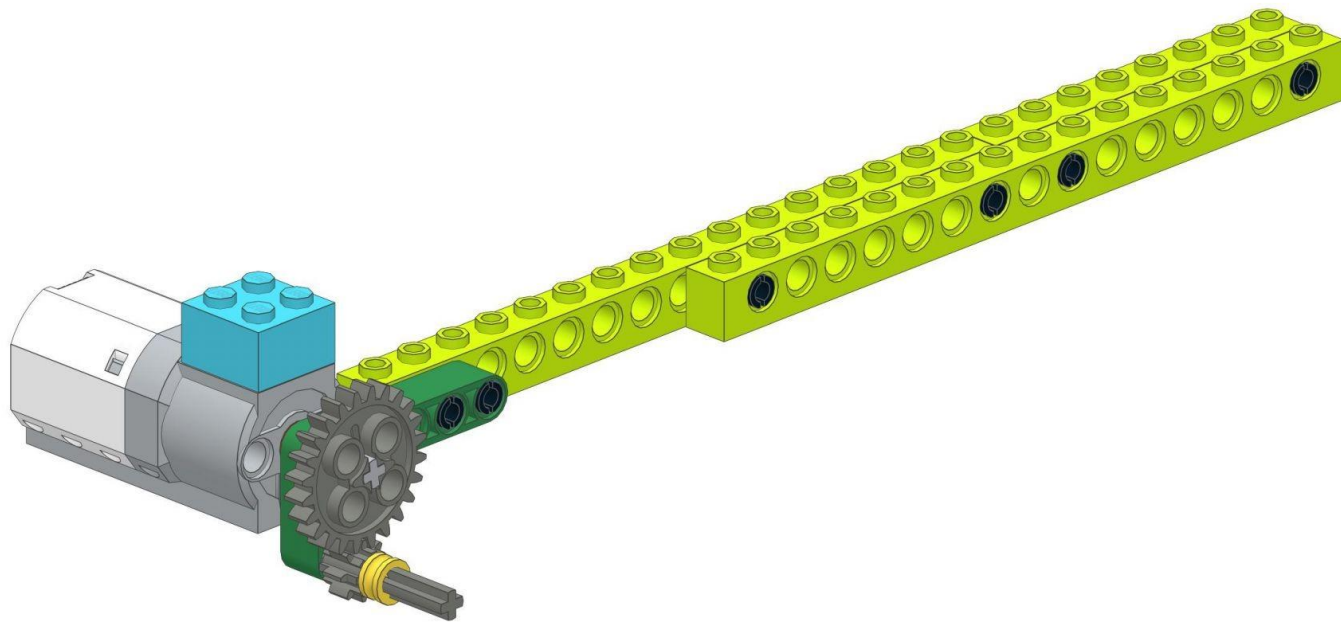
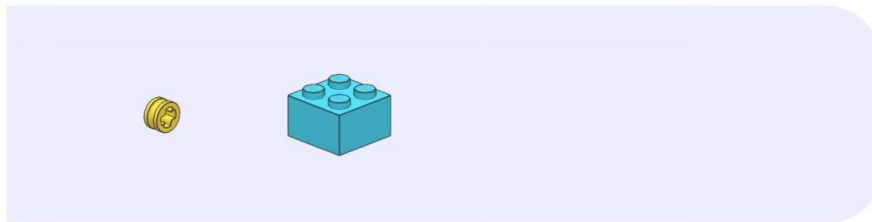

009

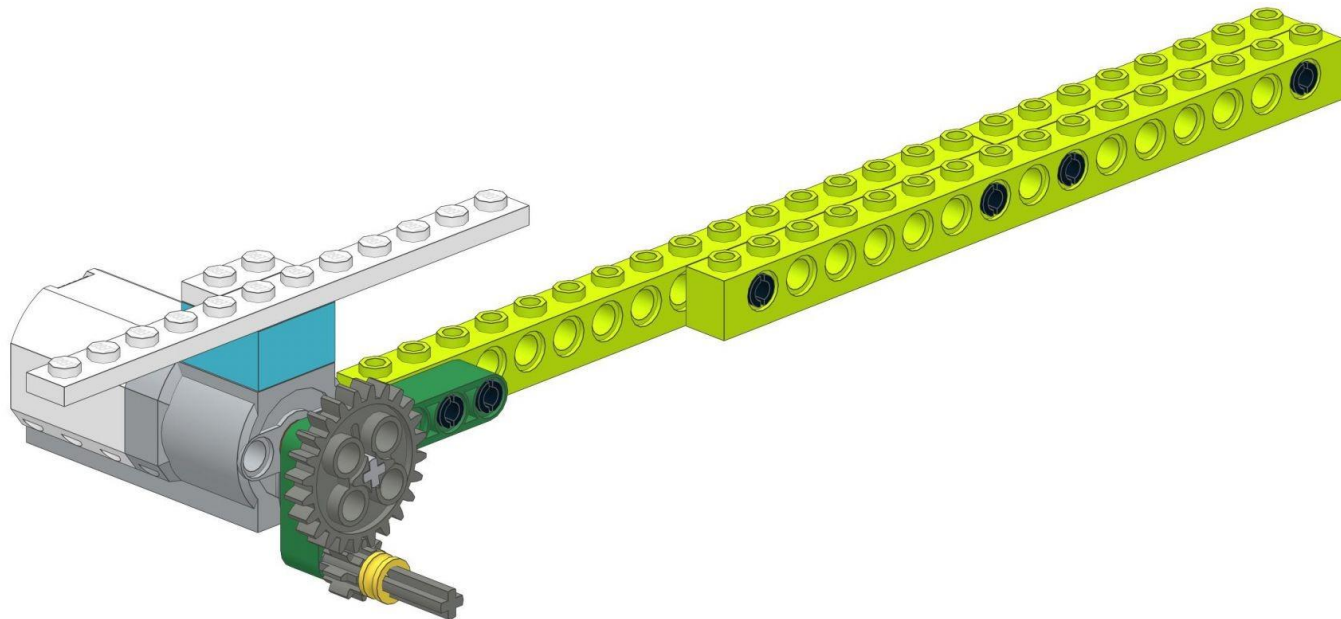
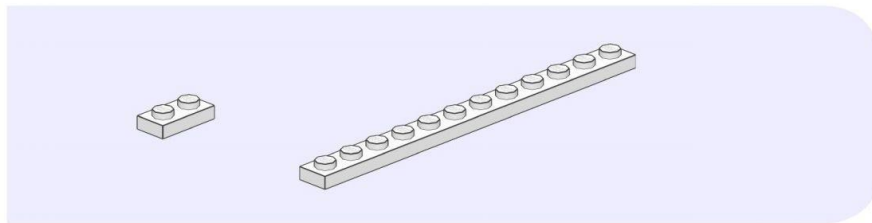

010

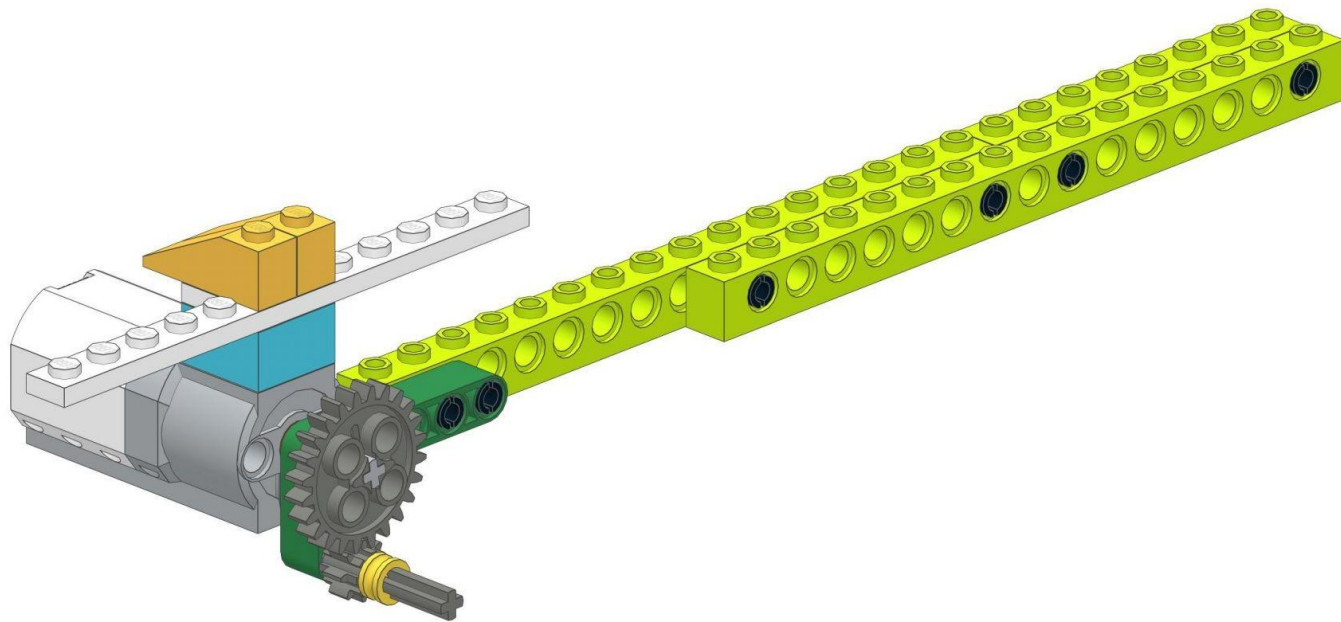
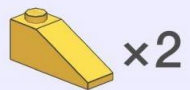

011

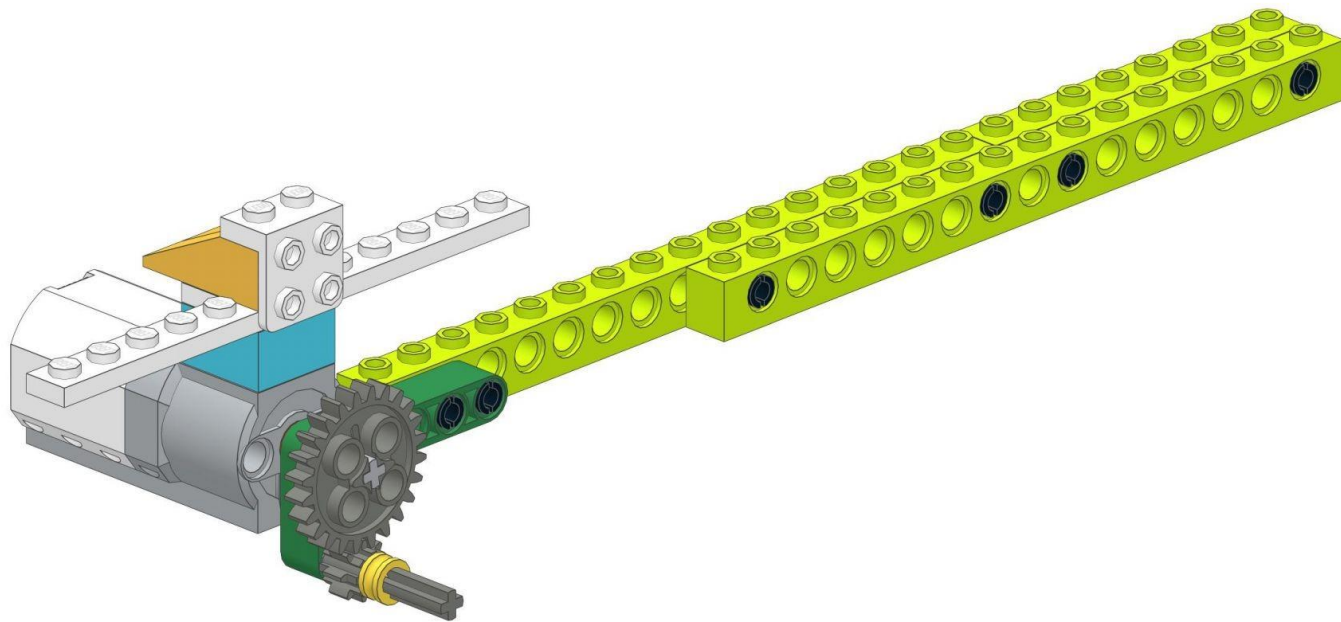
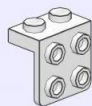

012

○ x2

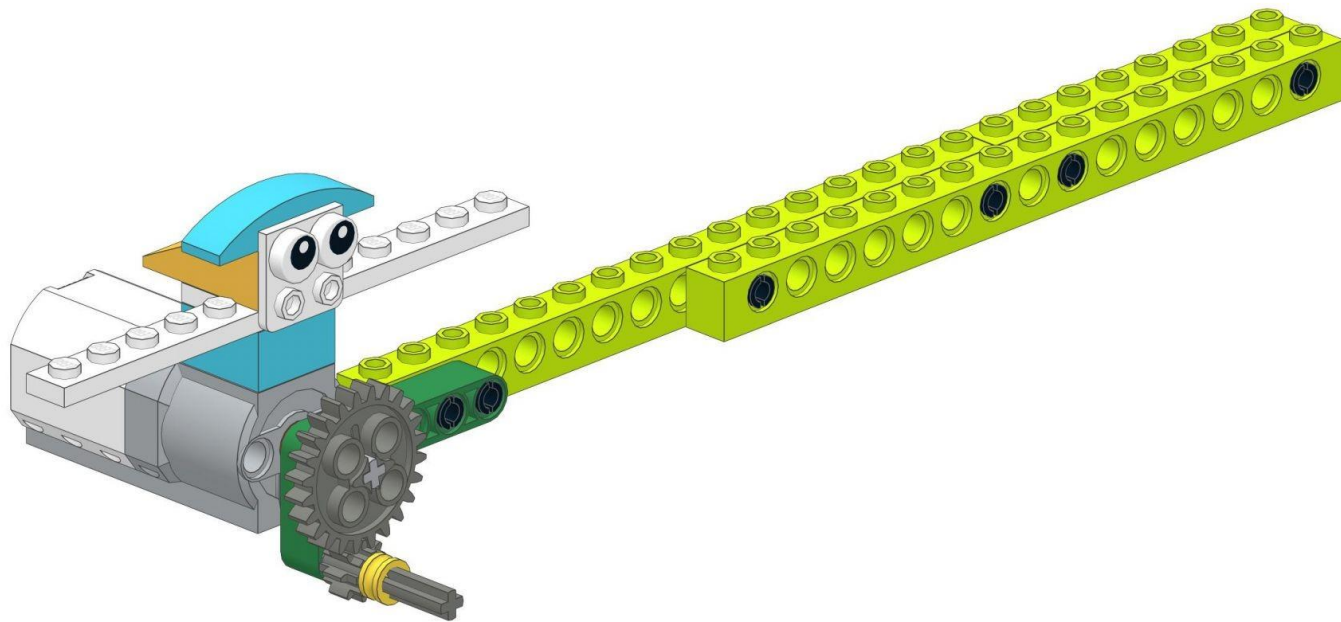

013

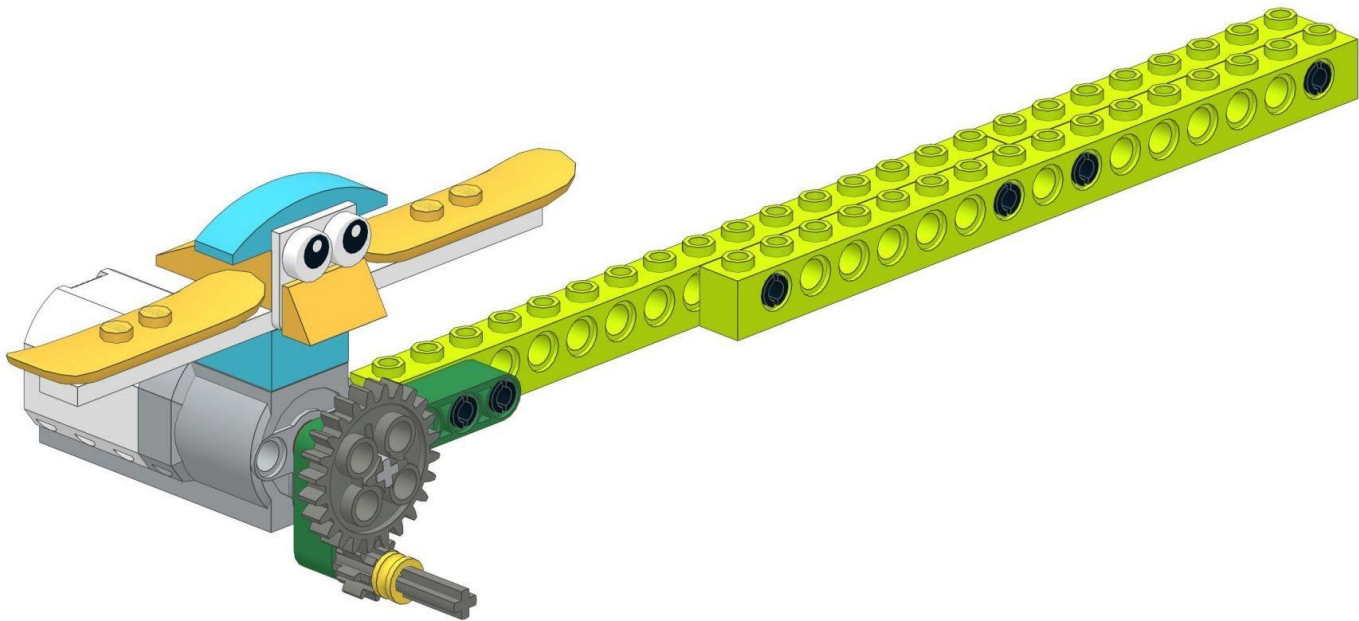
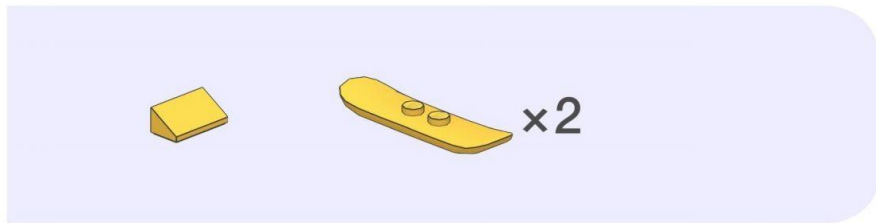

014

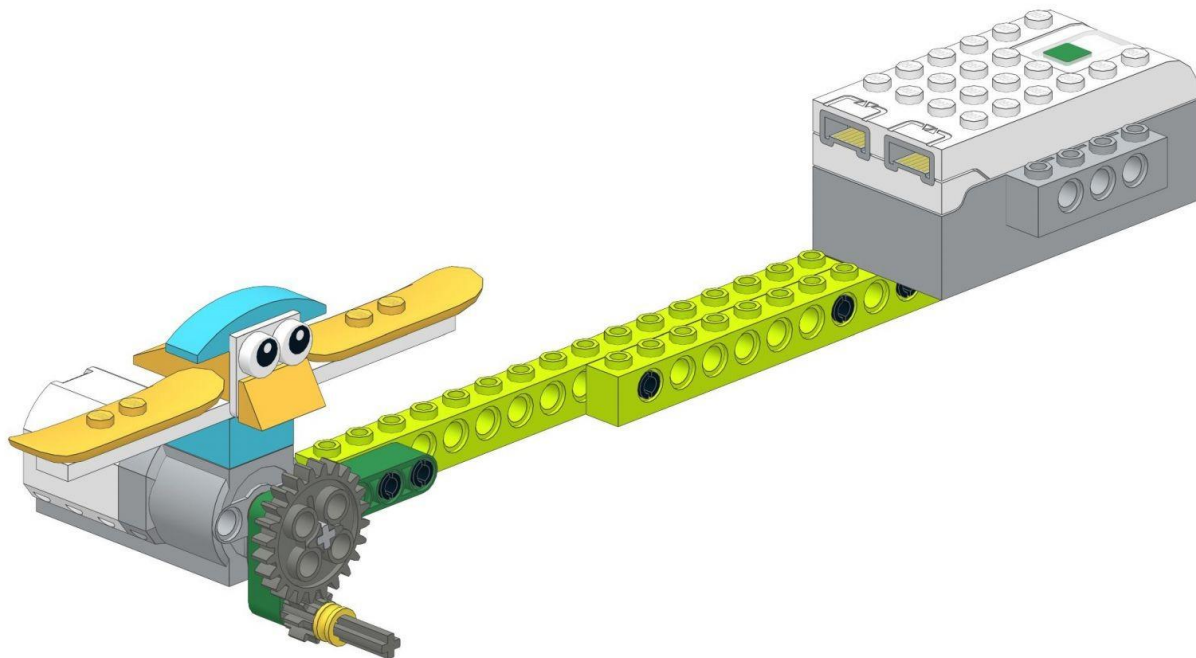
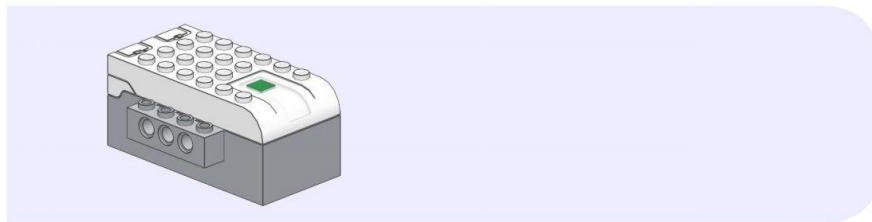

015

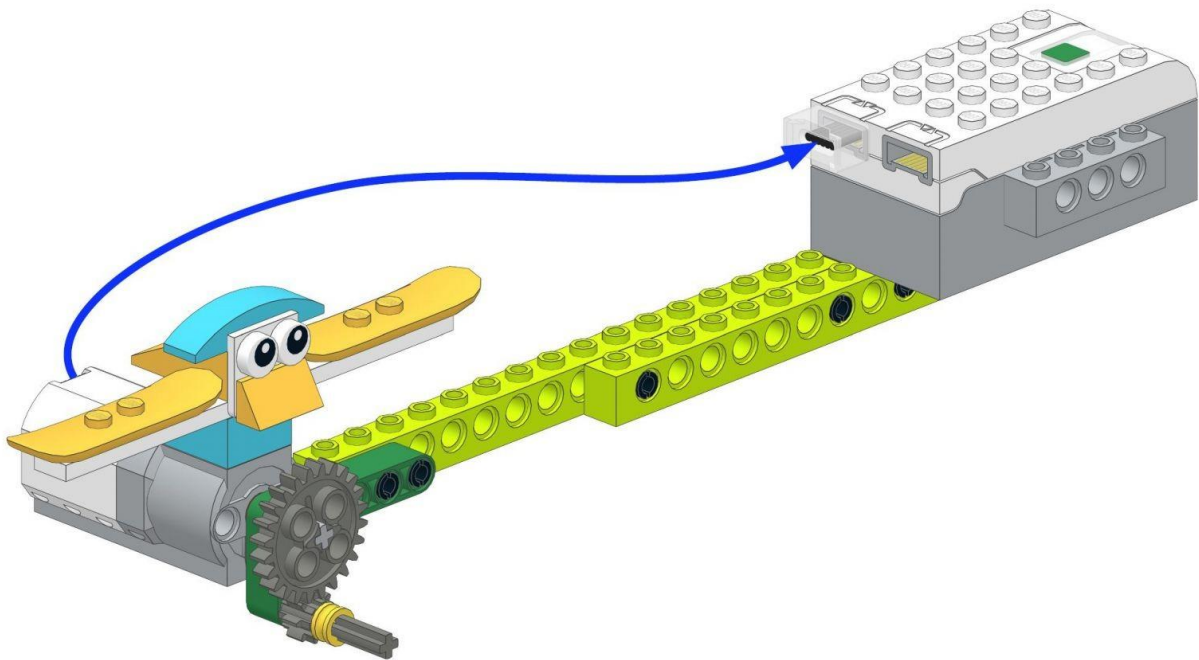

016

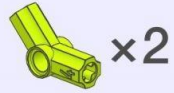

x2



x2

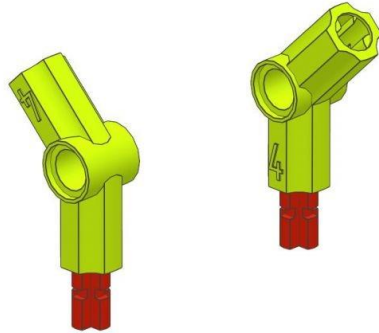

017

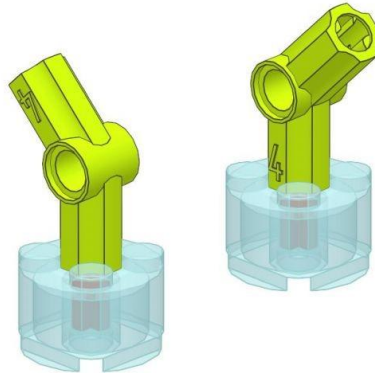

018

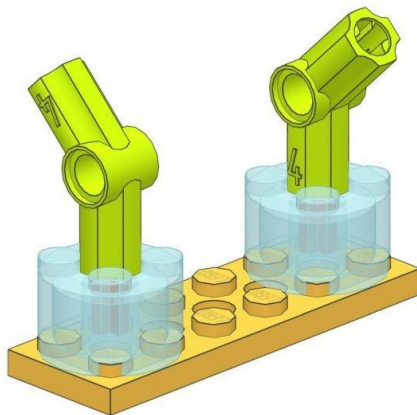
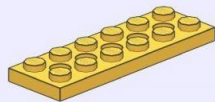

019

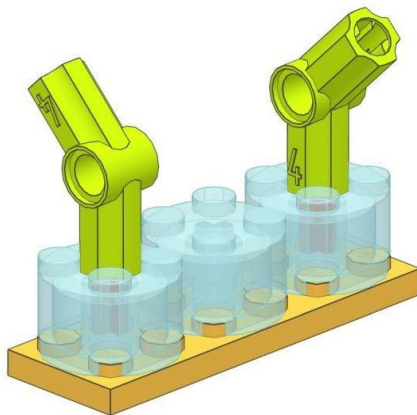

020

 x2

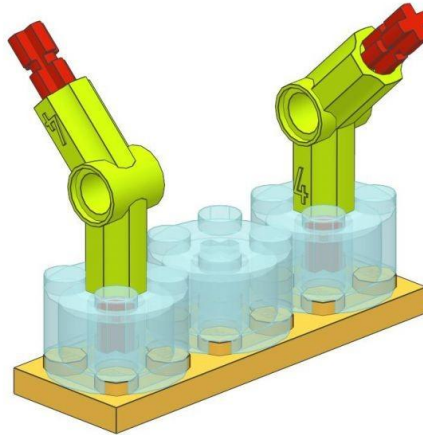

021

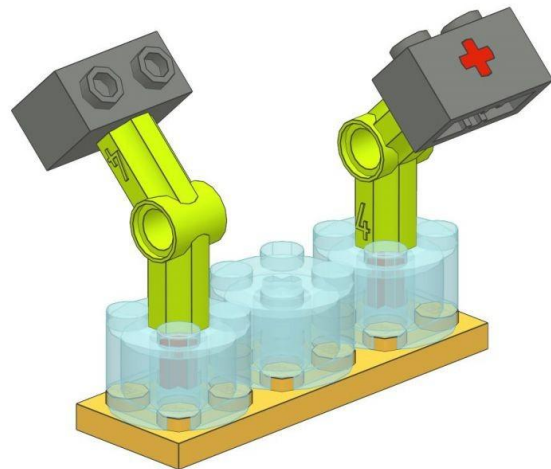
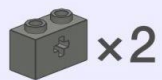

022

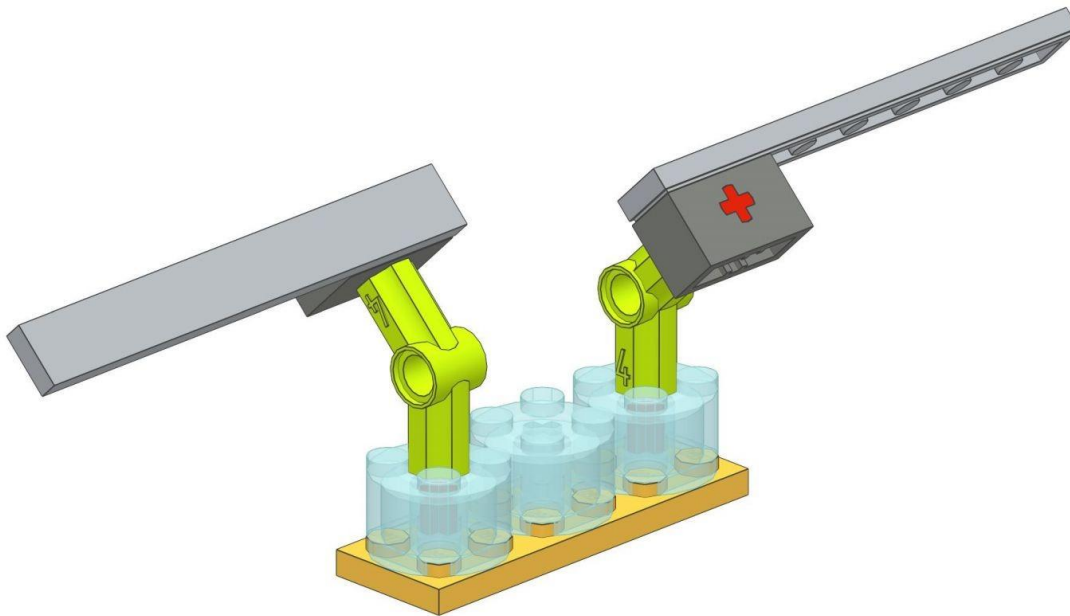
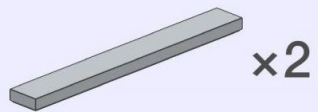

023

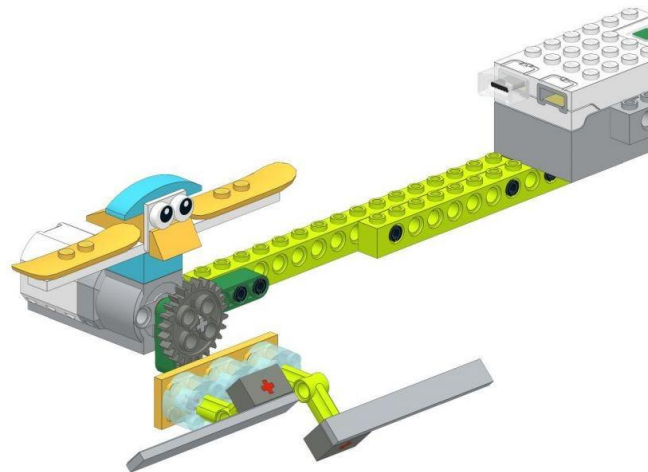
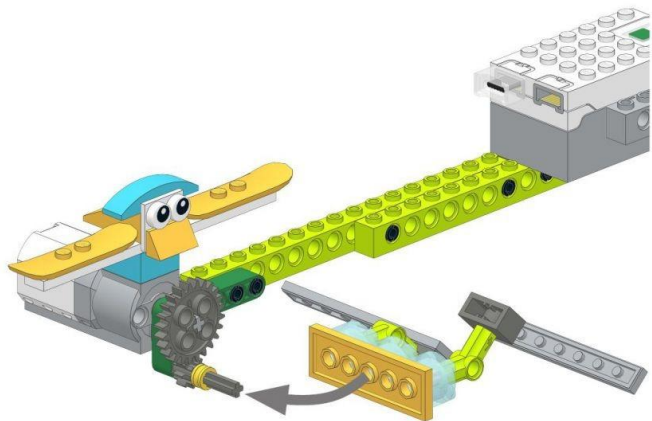

024

 x2

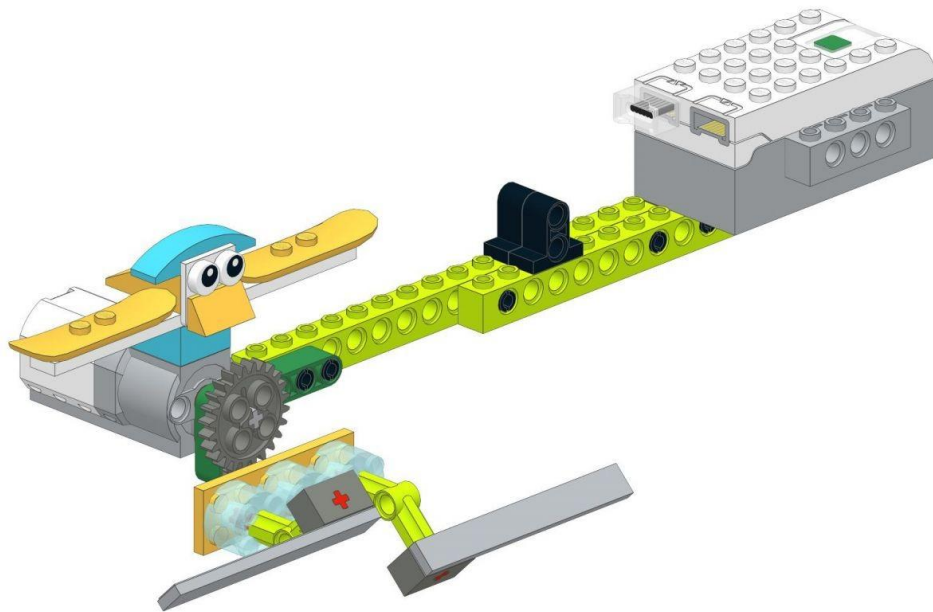

025

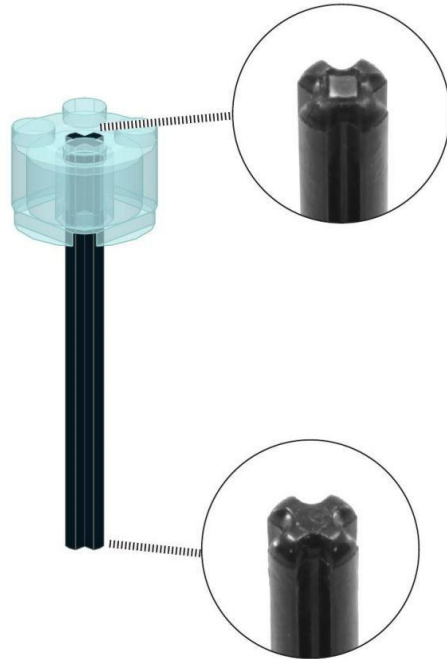

026

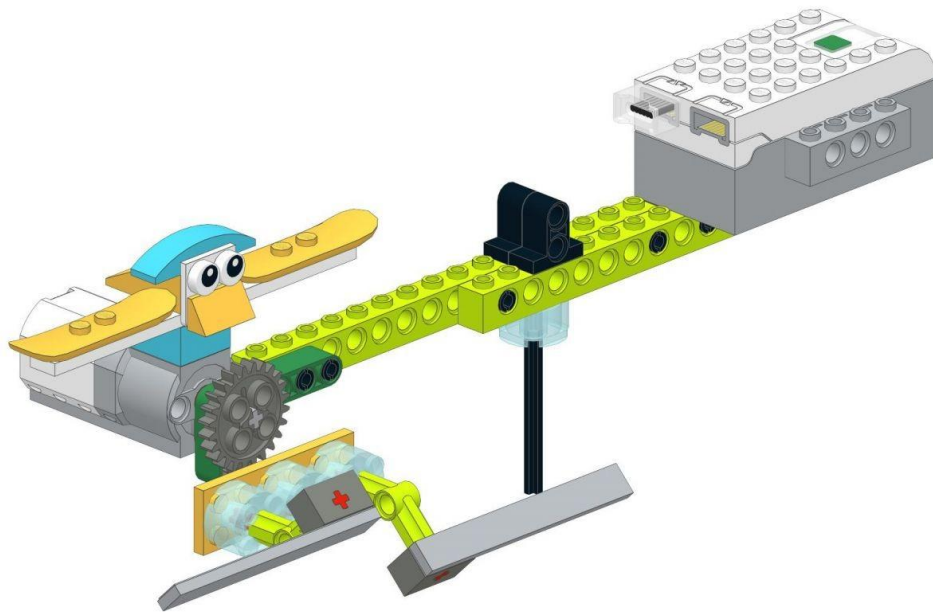

028

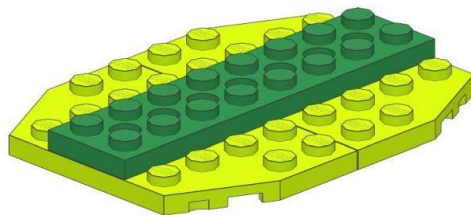
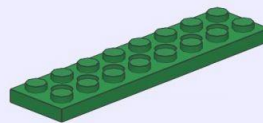
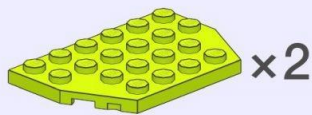

029

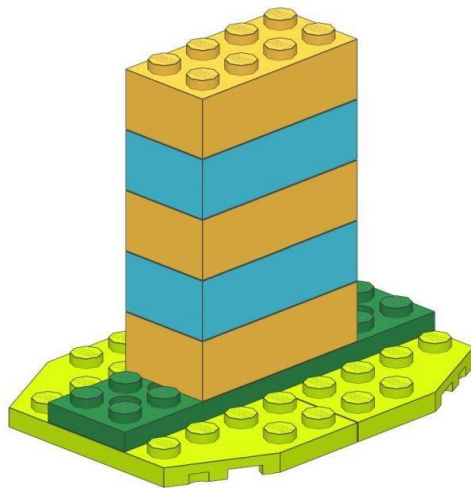
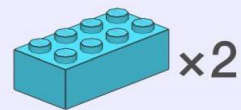
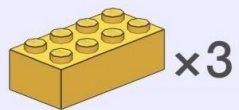

030

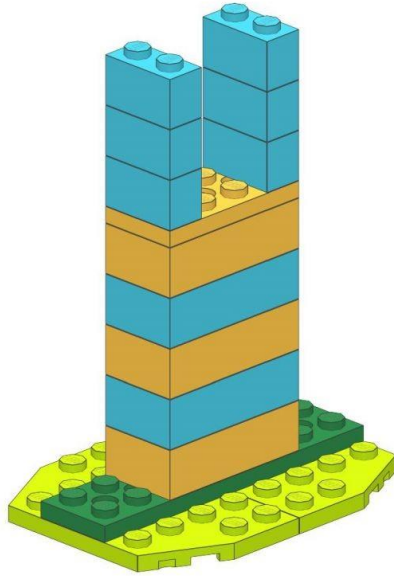
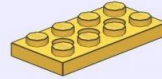
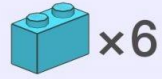

031

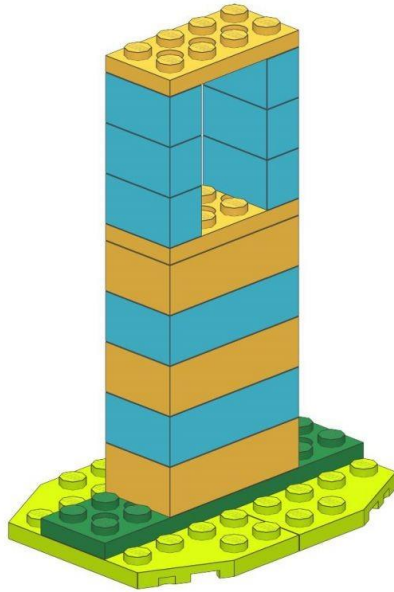
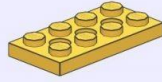

032

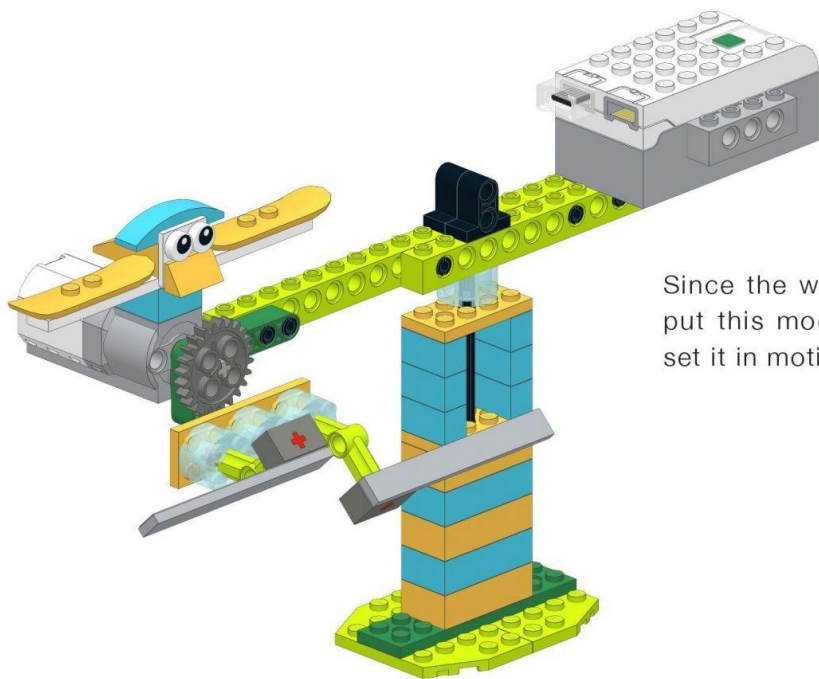

Since the wind power of the fan is not very strong, put this model in as flat a surface as possible and set it in motion.



Запускаем





Усложняем программу





Время общего селфи





Проверяем явки

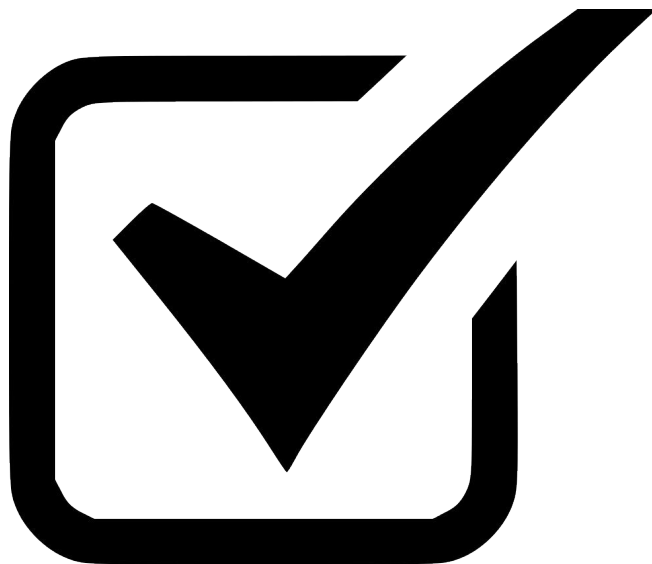



До новых встреч!



Что узнаем?

- ✦ Понижающая передача
- ✦ Источники энергии
- ✦ Солнечные батареи

Собери:

- ✦ Солнечные батареи
- ✦ космические корабли

Новая глава

A cartoon boy with brown hair, wearing a blue and yellow striped shirt and blue shorts, stands next to a glowing blue doorway in a notebook. He is pointing towards the doorway with a curious expression. The notebook is open, showing handwritten text and a drawing of a yellow robot.



Спасибо за занятие!

До новых встреч