

INVENTIONS THAT SHOOK THE WORLD



Education brings a child the world

ПРЕЗЕНТАЦИЯ УЧИТЕЛЯ АНГЛИЙСКОГО ЯЗЫКА ШИМИНОЙ Н.В.

DO YOU KNOW THAT...

- Henry Ford invented the assembly line in 1903
- Alexander Bell invented the telephone in 1876
- John Lodgie Baird invented colour television in 1928
- Alexander Fleming invented penicillin in 1928
- Igor Sikorsky invented a helicopter in 1909
- Sergei Korolev invented a satellite Sputnik 1
- Richard Drew perfected the scotch in 1928
- William O. Grover invented a sewing machine
- Alexander Popov perfected a wireless telegraphy in 1890
- Alfred Nobel invented dynamite in 1867
- Henry John Heinz perfected canned food in 1869
- John Walker invented matches in 1827



INVENTIONS IN RUSSIA

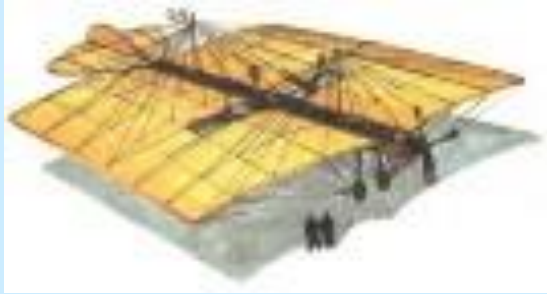

Alexander Mozhaisky

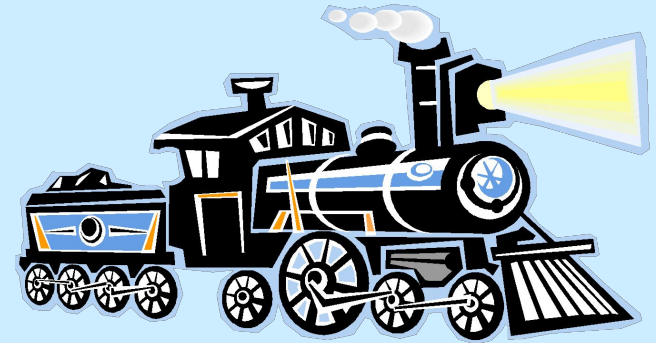

The Cherepanovs



Igor Sikorsky

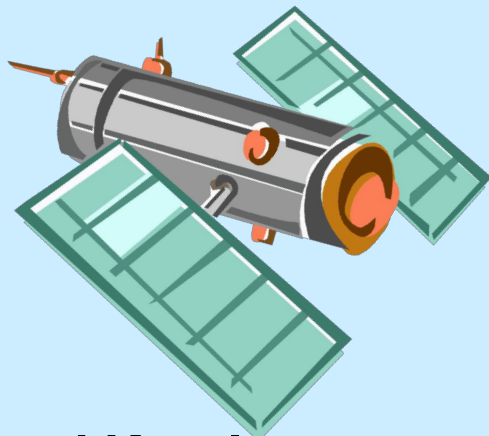

Sergei Korolev



Alexander Lodygin

**MATCH THE COUNTRY, THE THING, THE NAME OF THE INVENTOR AND
THE YEAR OF THE INVENTION**

Inventions	Inventors	Countries	Years
Telescope	Rudolf Diesel	Germany	1892
Matches	Theodore H. Maiman	The USA	1960
Diesel	George Eastman	The USA	1888
Laser	Igor Sikorsky	Sweden	1888
Dynamite	Joy Boyd Dunlop	Scotland	1867
Helicopter	Alfred Nobel	The USA	19
Tyres	Hans Lippershy	Netherlands	1608
Kodak camera	John Walker	England	1827

WHY PEOPLE (DON'T) LIKE TO HAVE MODERN INVENTIONS IN EVERYDAY LIFE

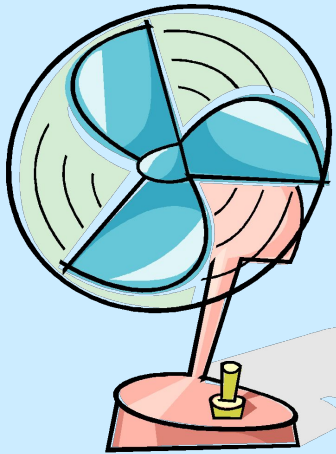

Life is easy/ exciting / enjoyable with it.
The main benefit is the speed with which we can.../
the price. It's reasonable.
the design. It's modern.

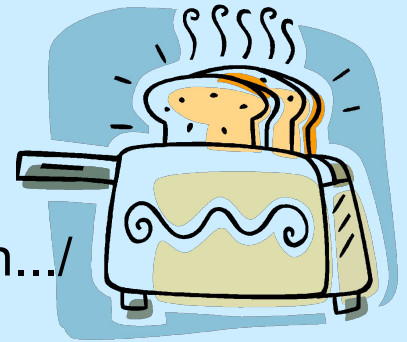

I don't worry about...
Using ... leaves me more time to enjoy myself.
... saves a lot of time.
... makes it possible/easy to...
... offers a lot of possibilities.
... suits everyone whatever your age.

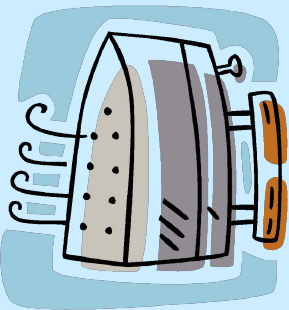

FIND THE ANSWER



...was invented by W. Grover in the USA in 1851.



...was invented by A. Bell in the USA in 1876.

...was invented by K. Benz and G. Daimler in Germany in 1903.

...was invented in the USA in 1940s.

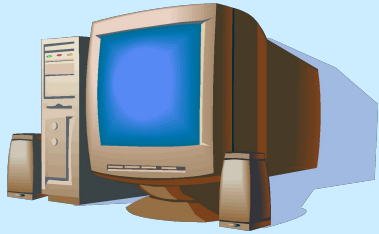

USE THE PICTURES TO COMPLETE THE WORD PUZZLE

1		I					
	2	N					
		3 V					
4		E					
5		N					
		6 T					
7		I					
	8	O					
9		N					
10		S					

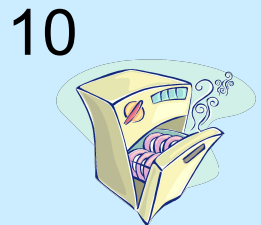
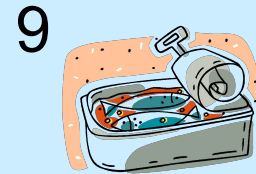
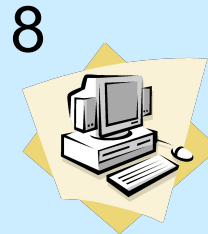
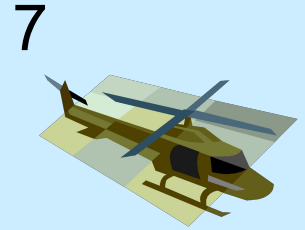
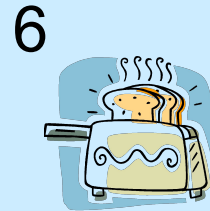

USE THE NAMES, DATES AND WORDS FROM THE COLLAGE TO COMPLETE THE FACTS FROM THE HISTORY OF SOME INVENTIONS

telephone





Henry Ford

John Logie Baird 1885

Alexander Fleming

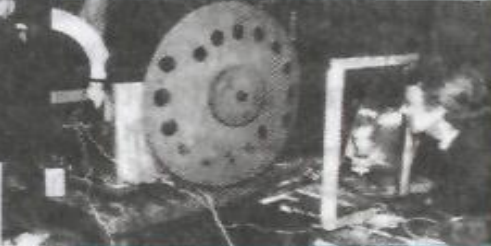
Thomas Edison 1895

1903



1957

Auguste and Louis Lumiere

Bill Gates 1928

Wilbur and Orville Wright

Sergei Korolev

Karl Benz