

АЗБУКА ГЕОМЕТРИЧЕСКОЙ РЕЗЬБЫ

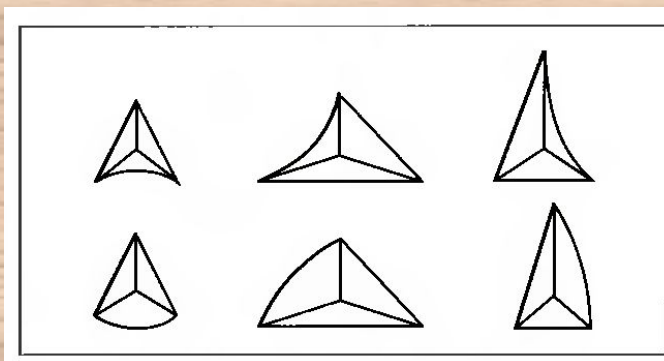

Сколышки

Пирамидки

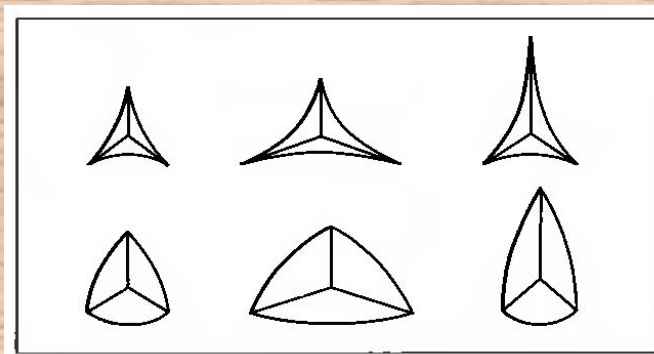
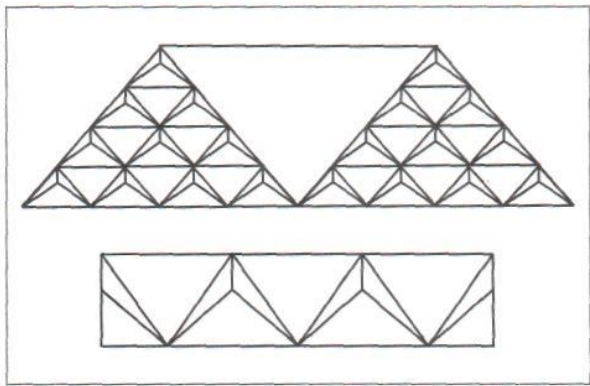
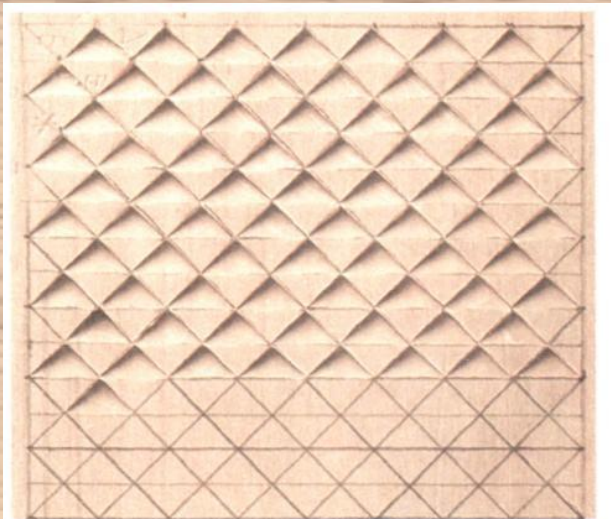
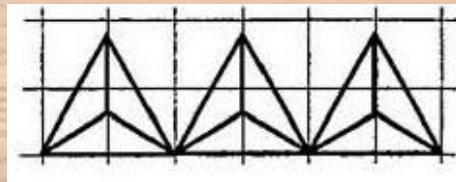
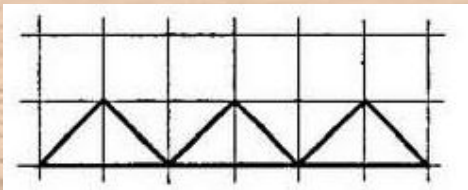
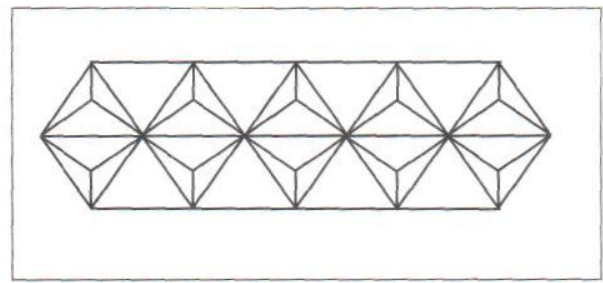
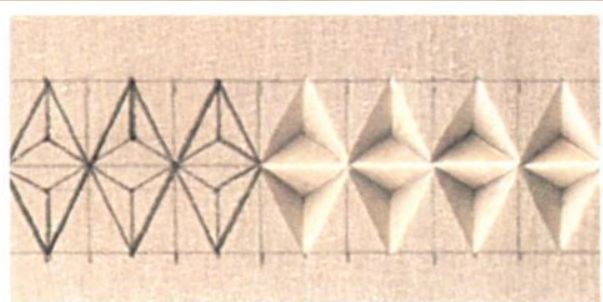

Цепочка

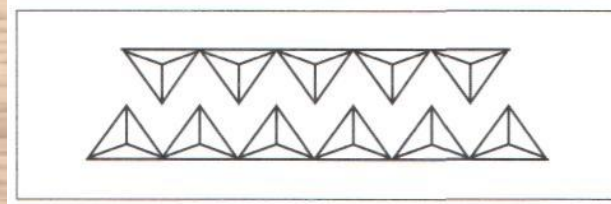
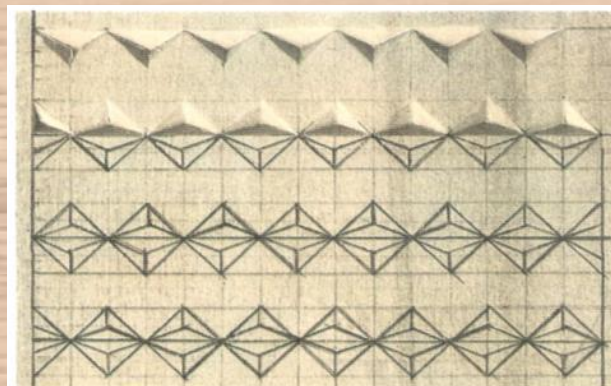

Змейка

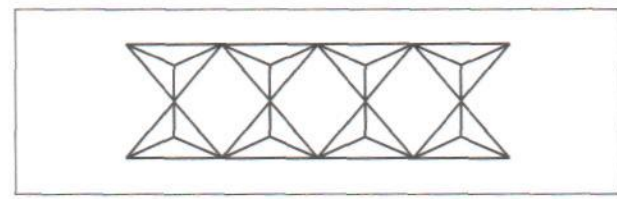
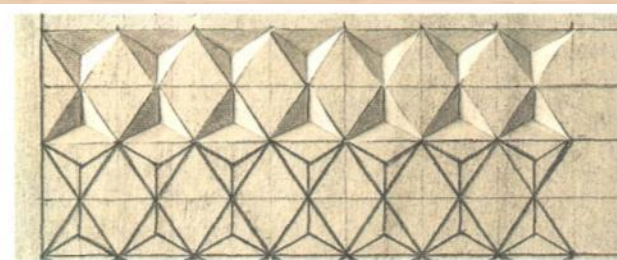

Бусины(ромбы)

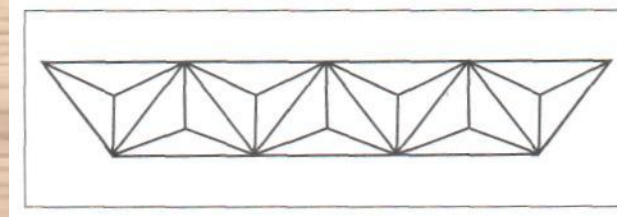
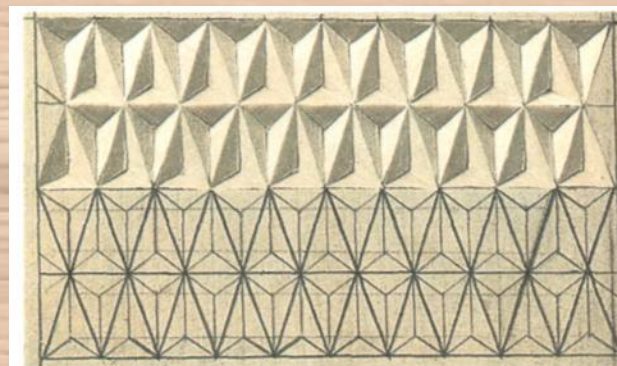

Витейка

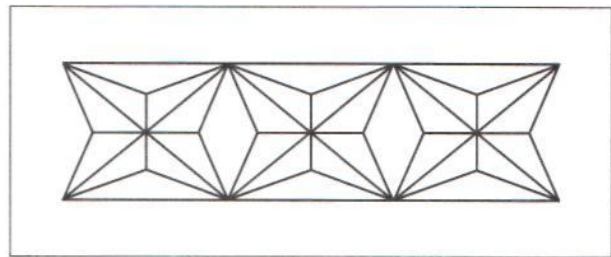
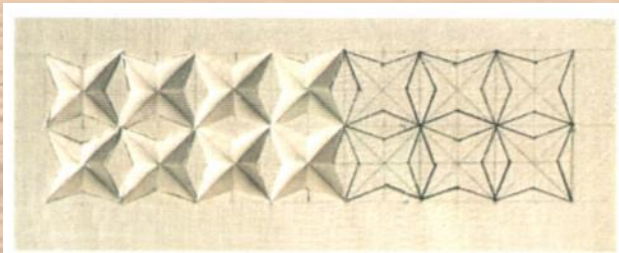

Звёздочка

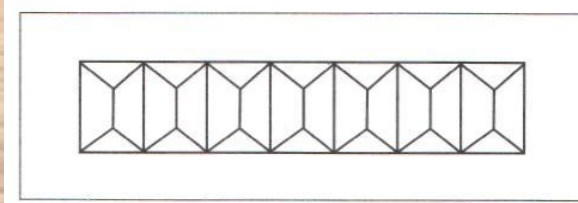
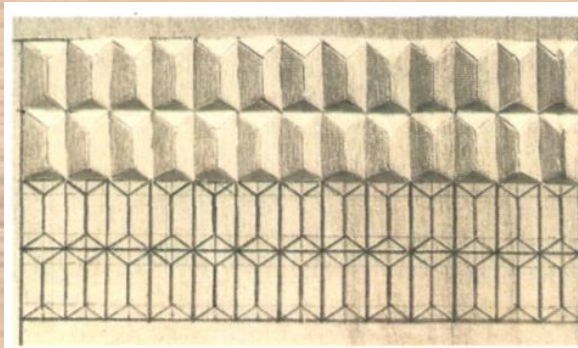

Лесенка

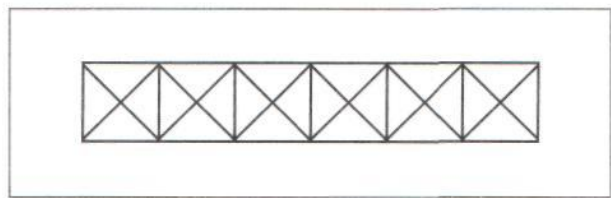
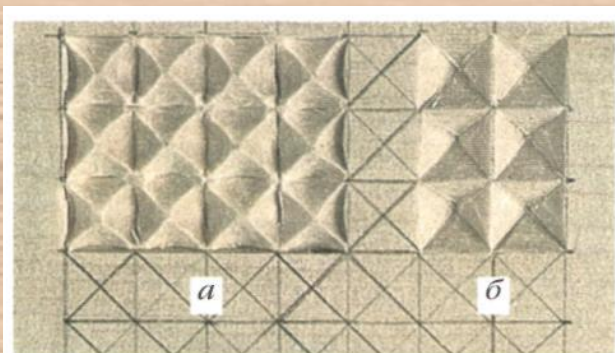

Соты: выпуклые (а) и вогнутые (б)

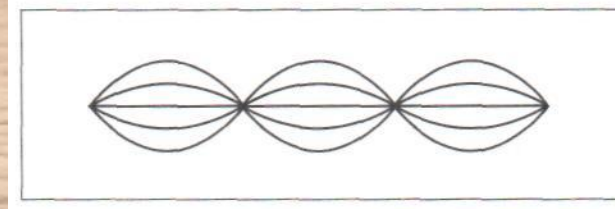
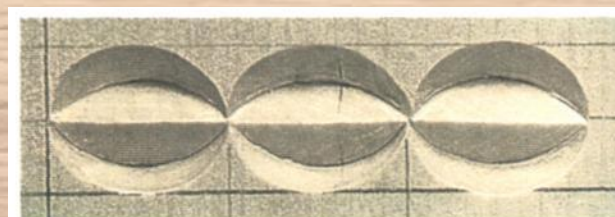

Глазки

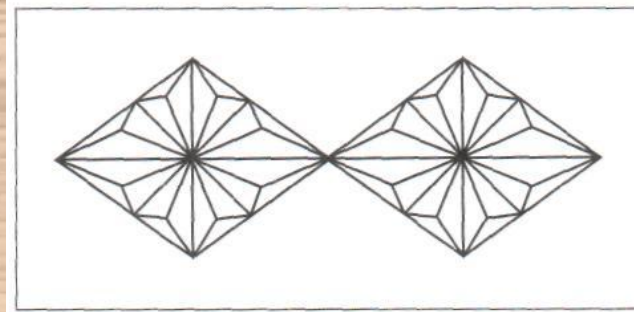
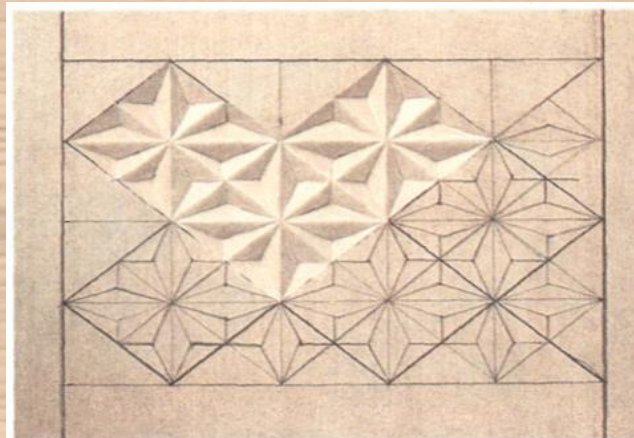
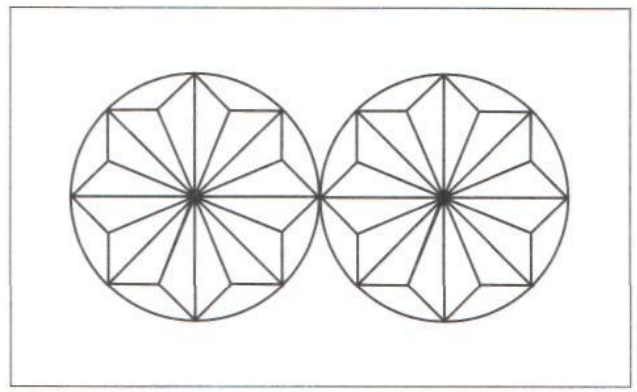
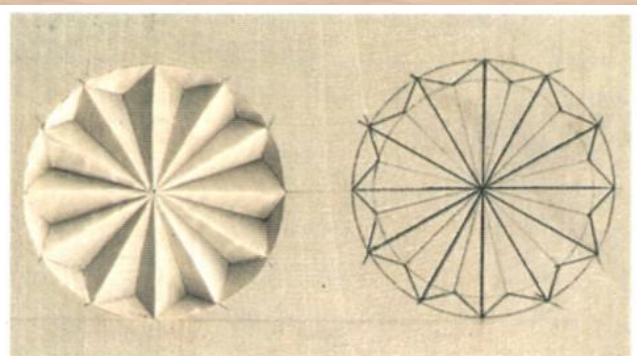

Паутинка (морщинки, насечка)

Розетка

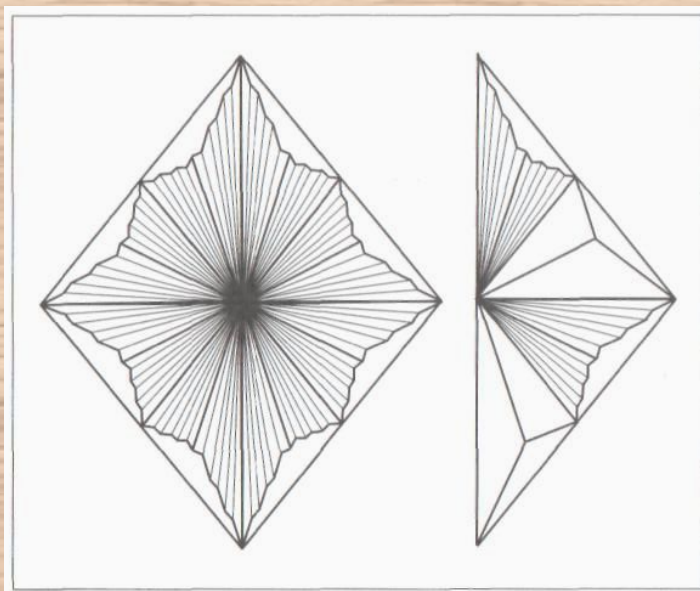

Сияние

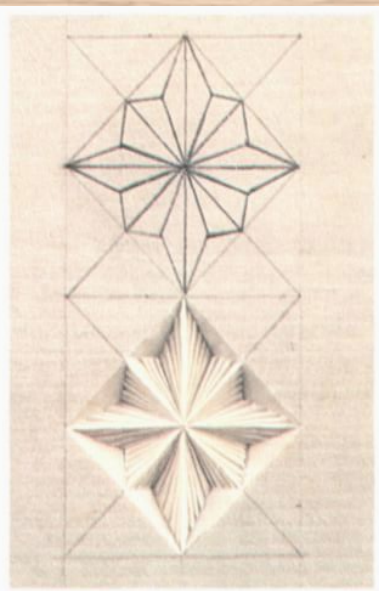

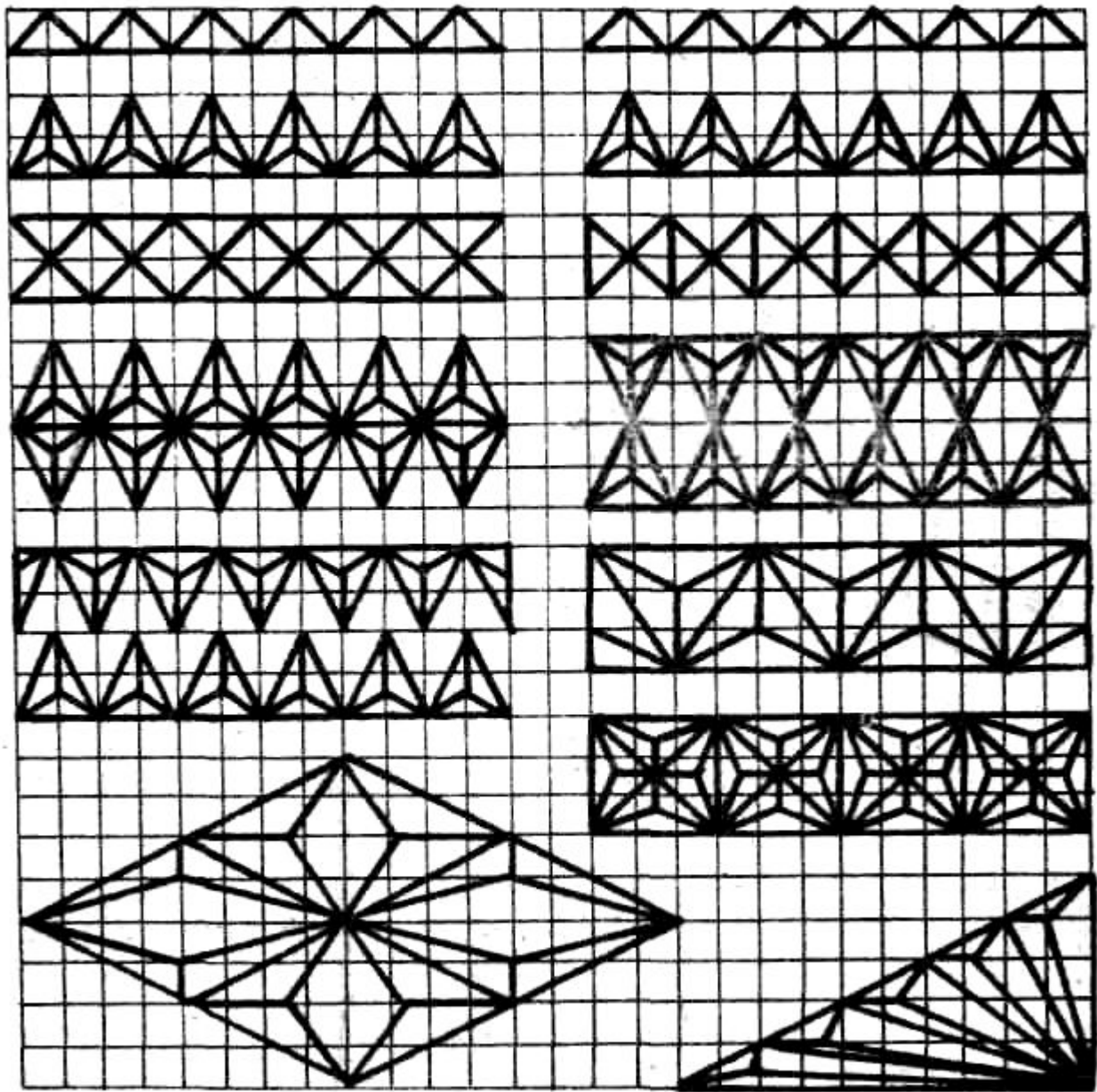

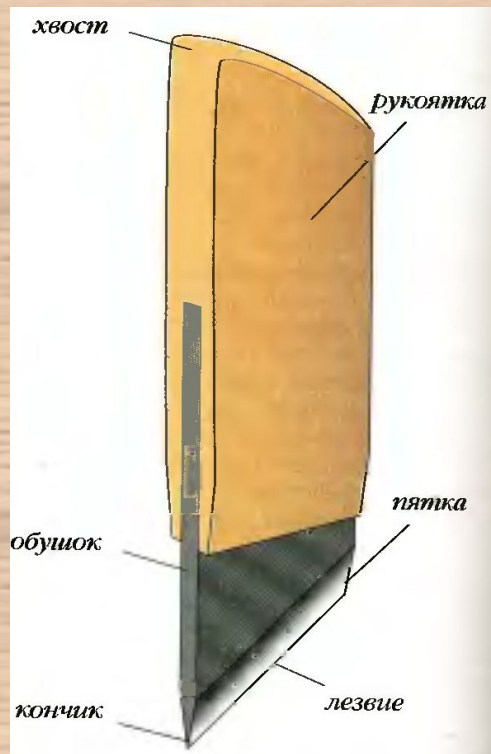

ЗАХВАТ РЕЗЦА

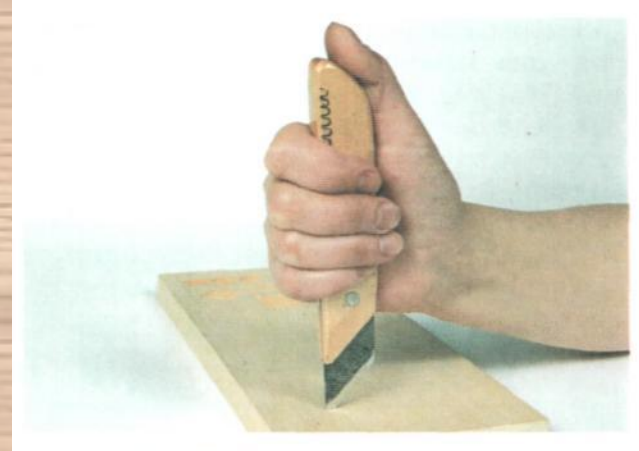

При резьбе на себя (способ 1)



При резьбе от себя



При резьбе на себя (способ 2)

ИЗГОТОВЛЕНИЕ РЕЗЦА

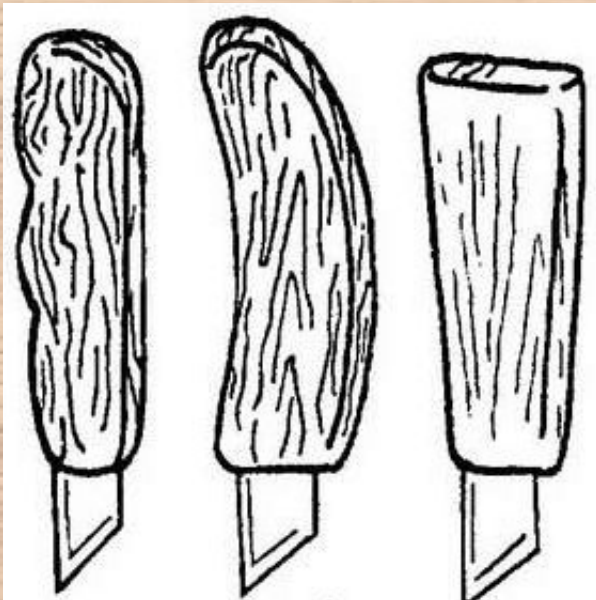
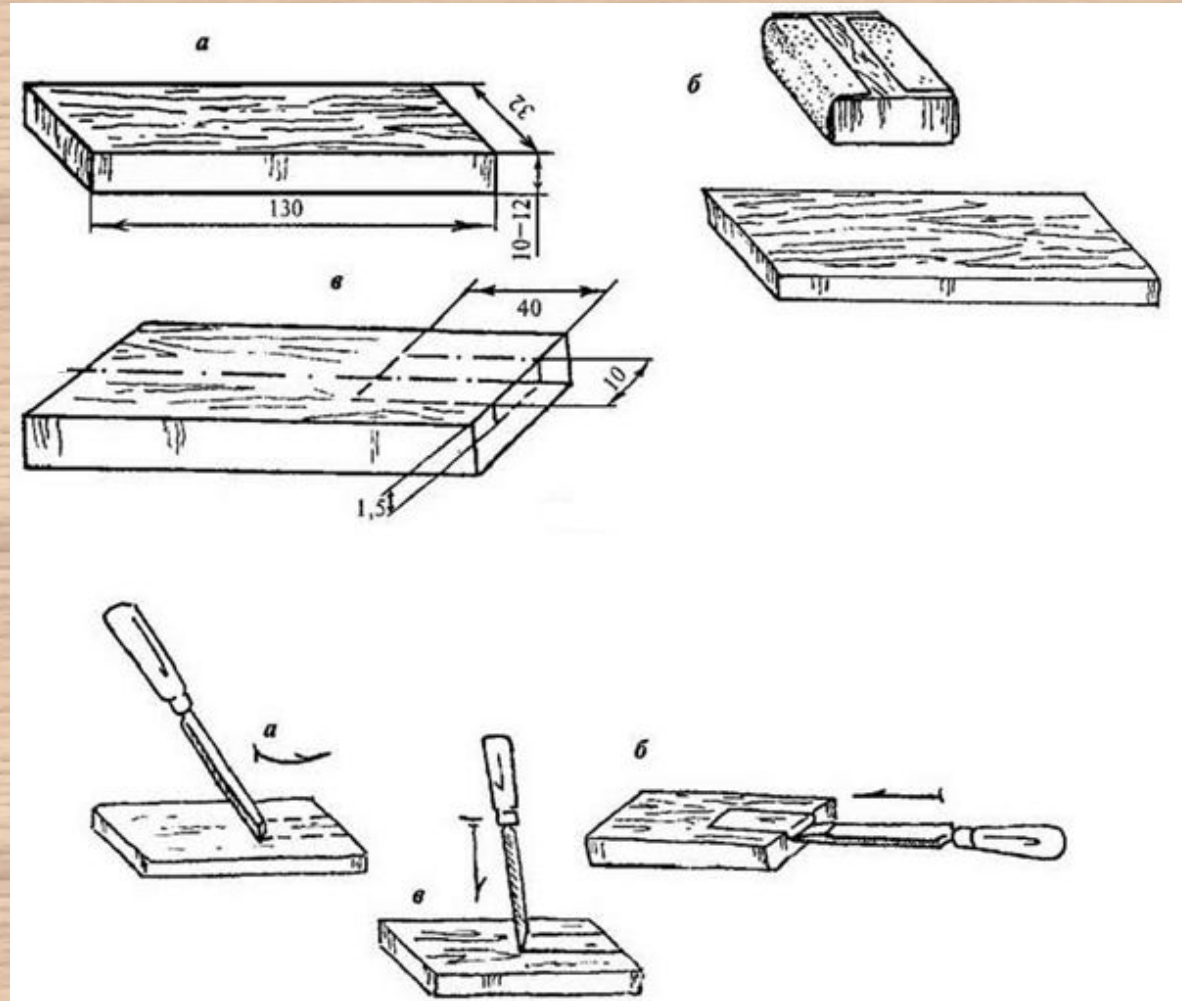
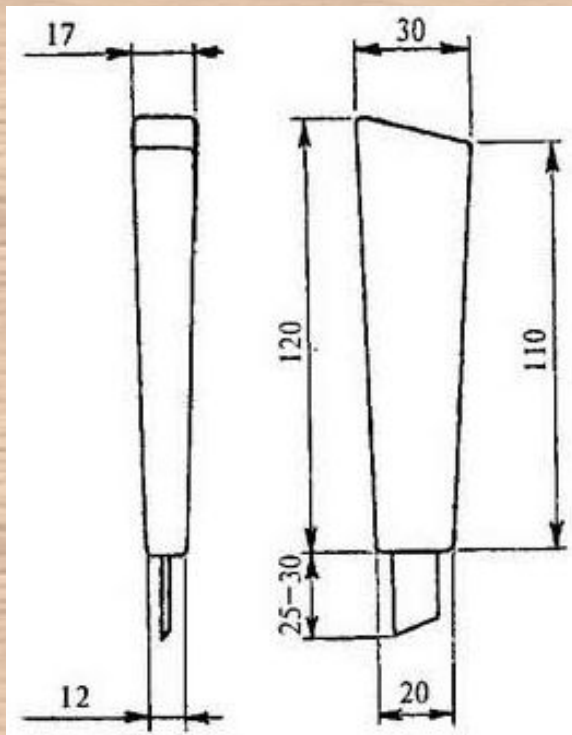

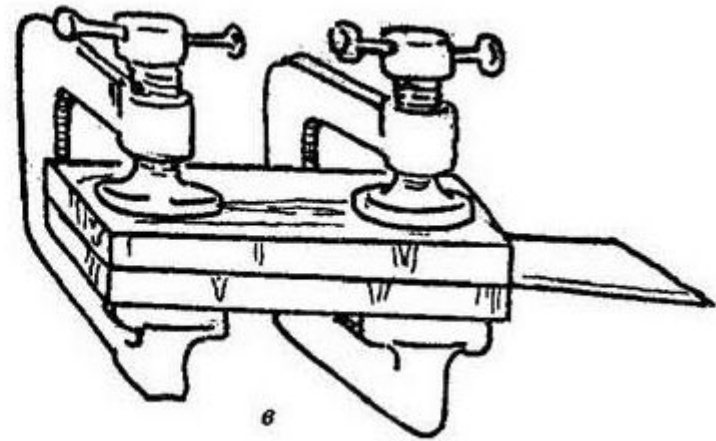
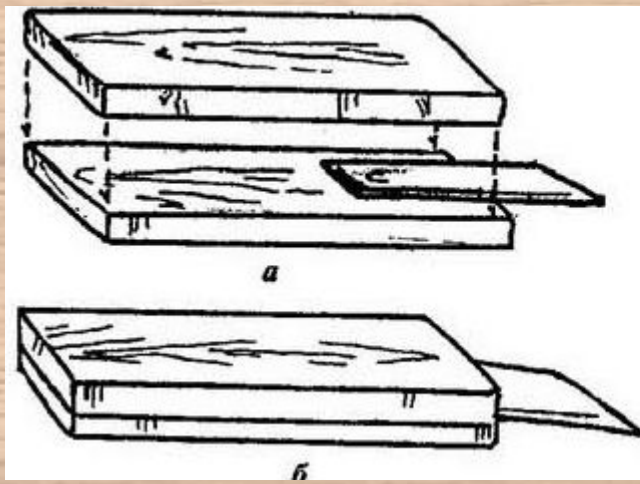
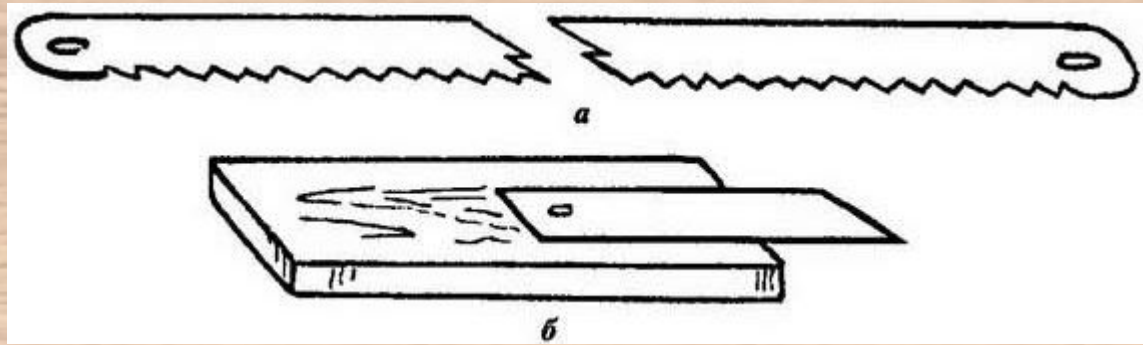

ЗАТОЧКА РЕЗЦА

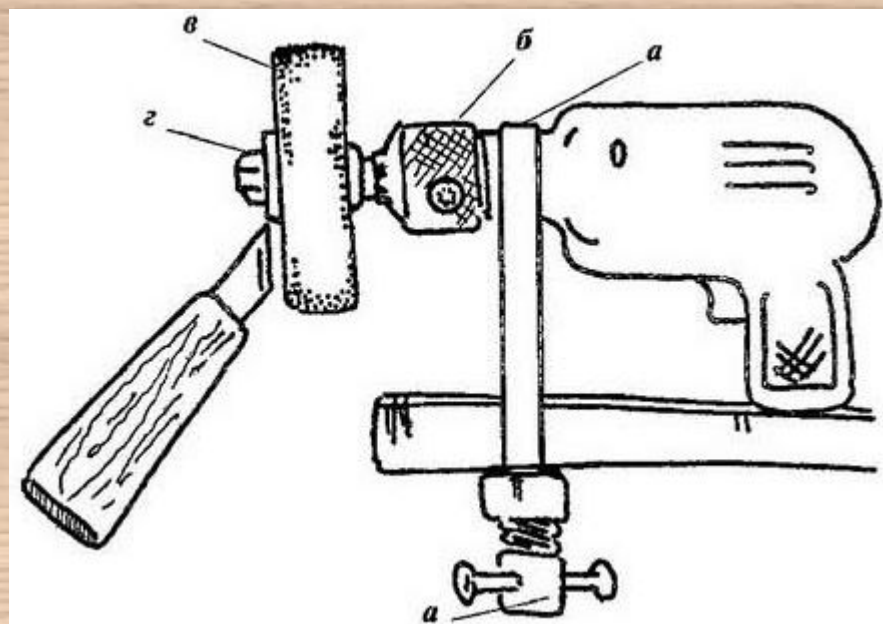
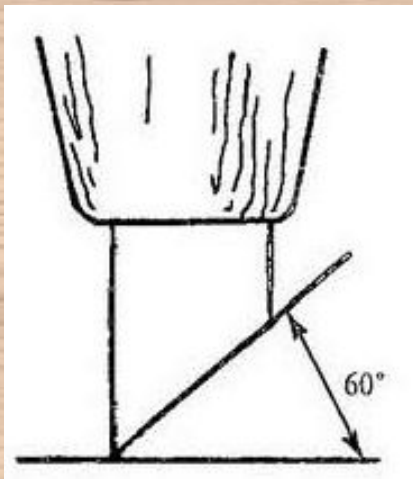

Заточка на электроточиле

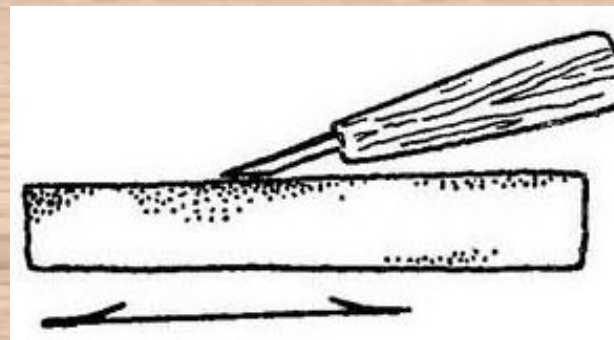
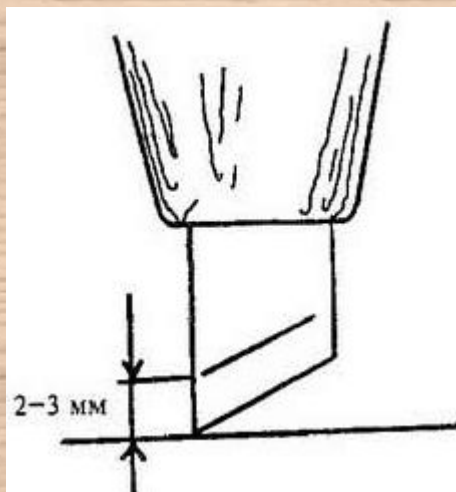

Правка на оселке

ТЕХНИКА БЕЗОПАСНОСТИ ПРИ ЗАТОЧКЕ РЕЗЦА

