

CAN System

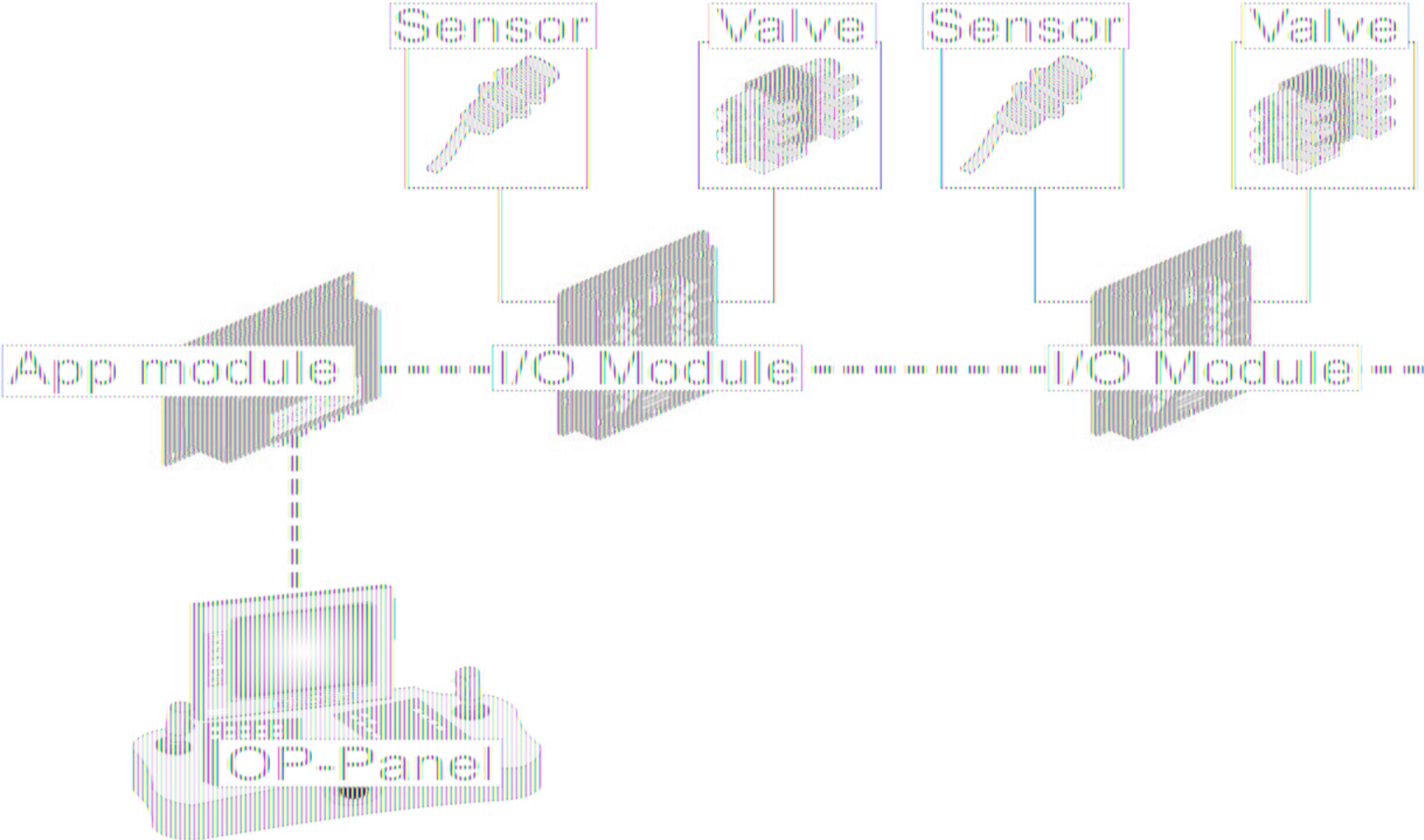

Exercise

Process control



Process control

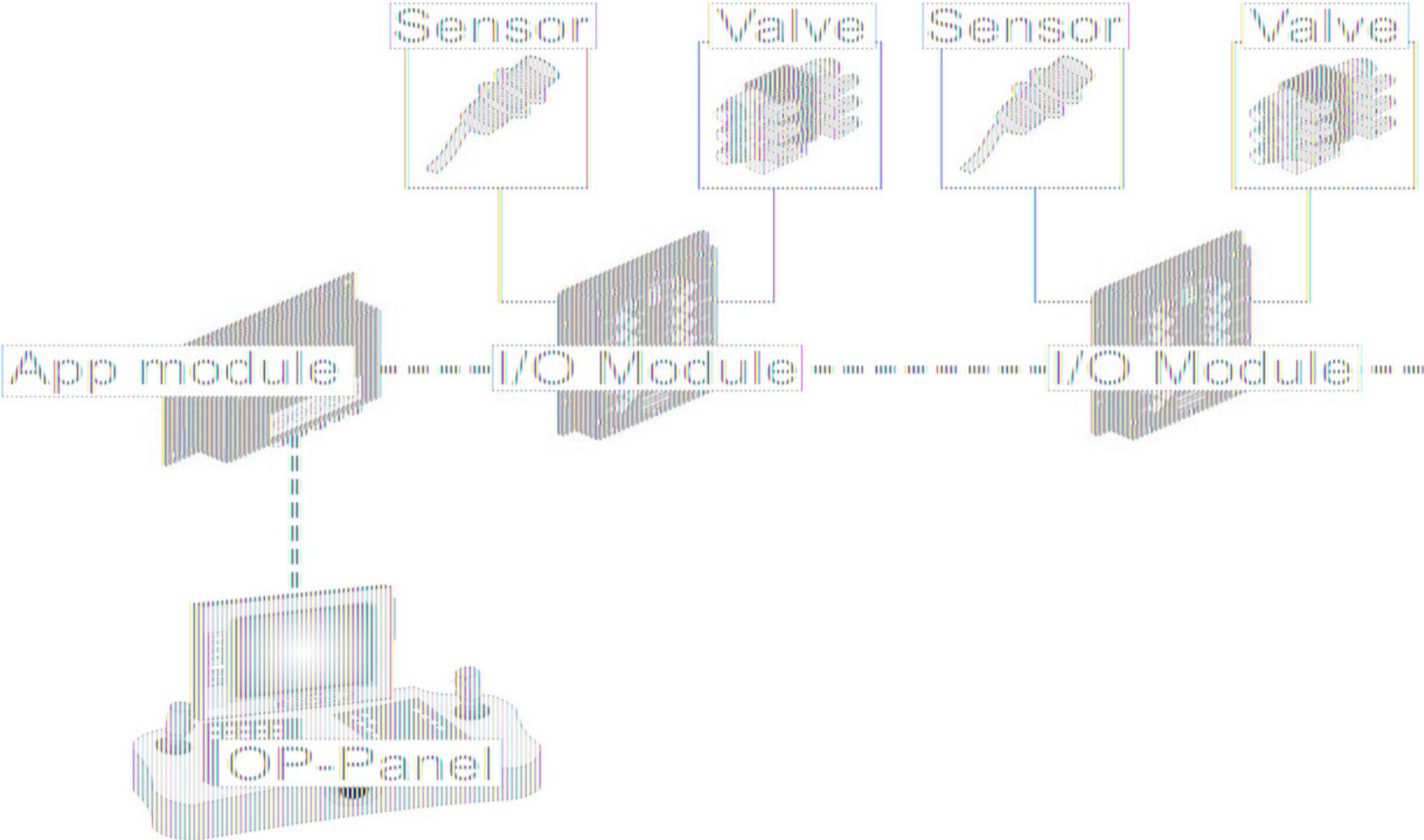

Modules

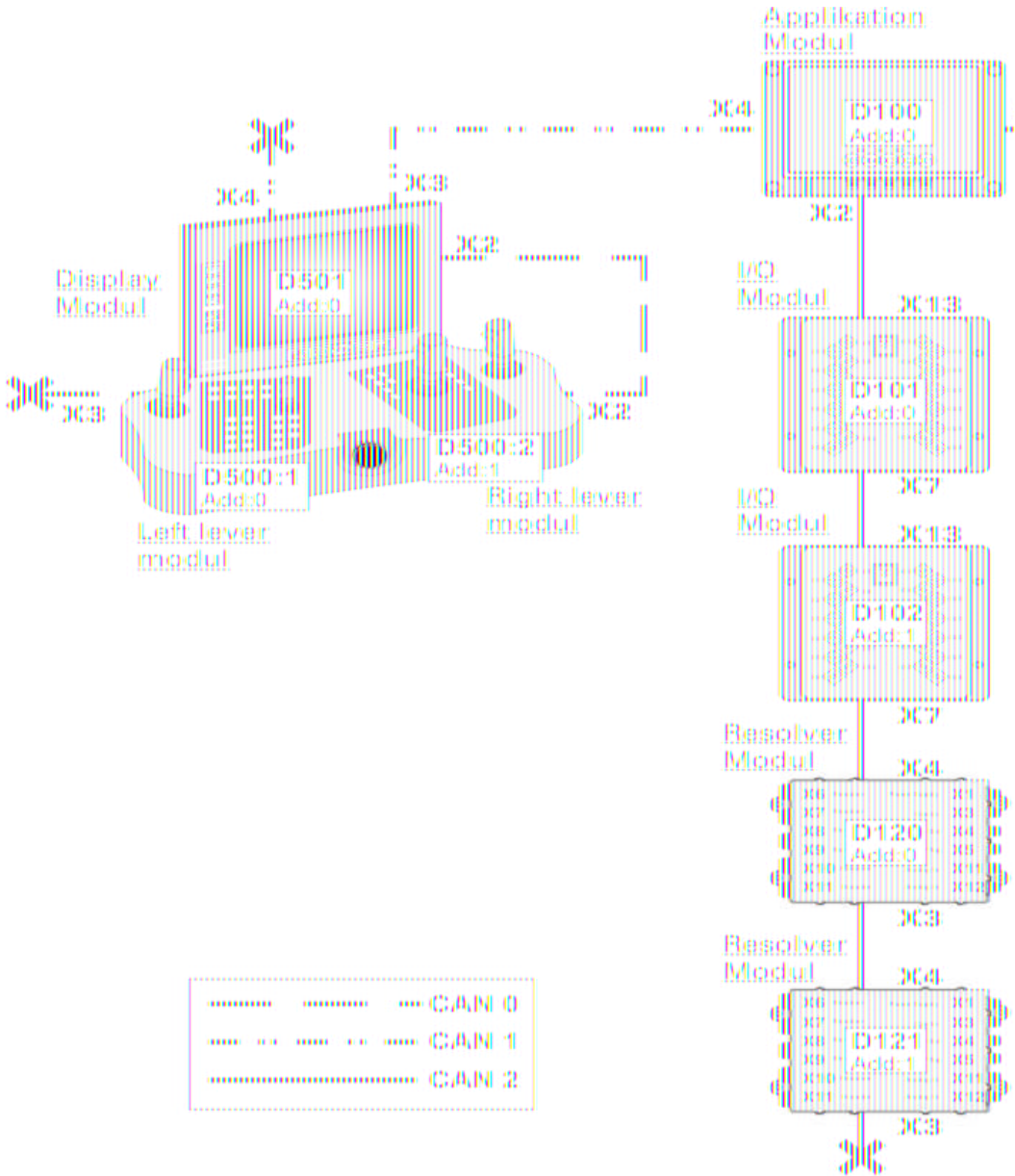

Modules

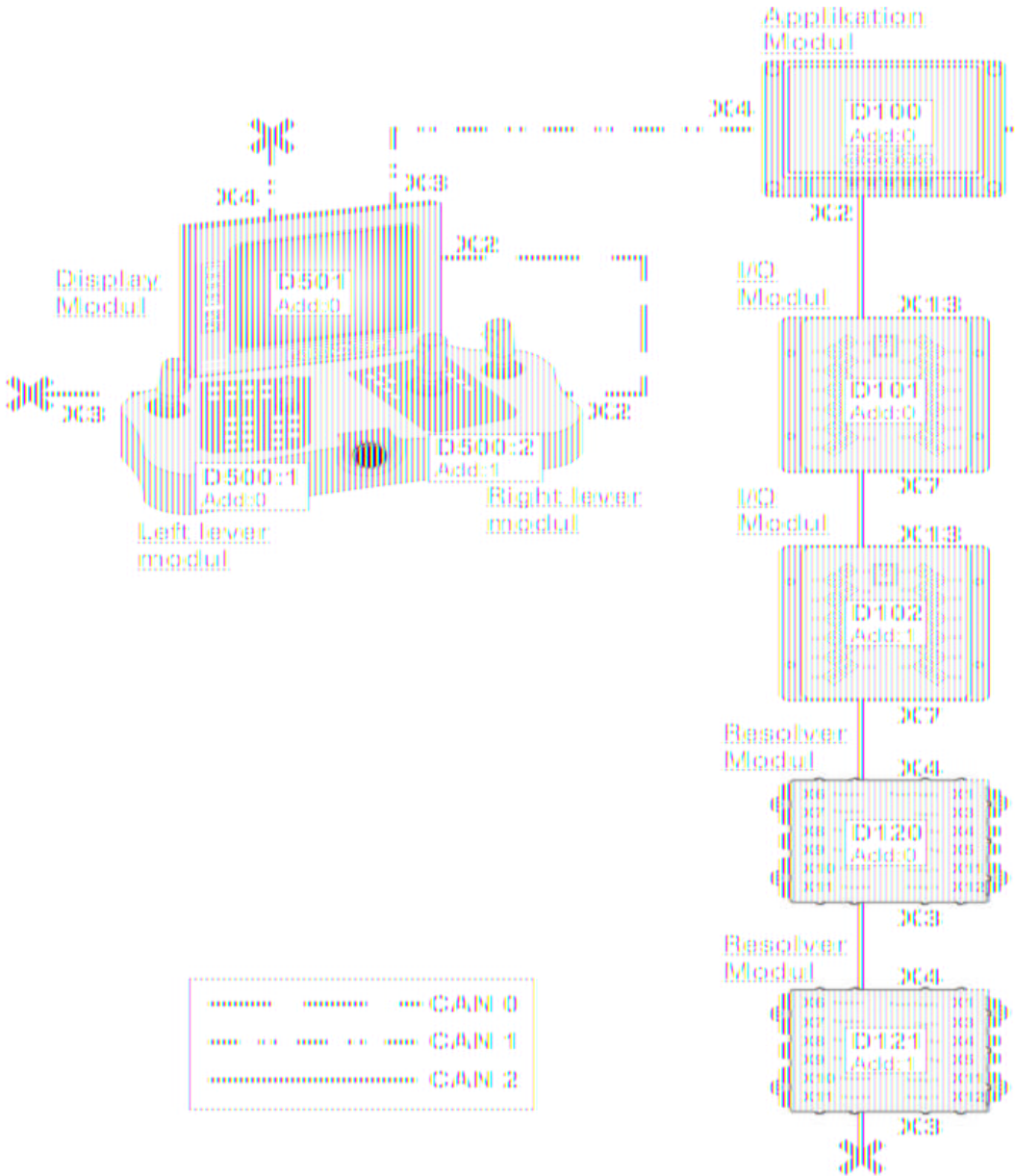

Modules

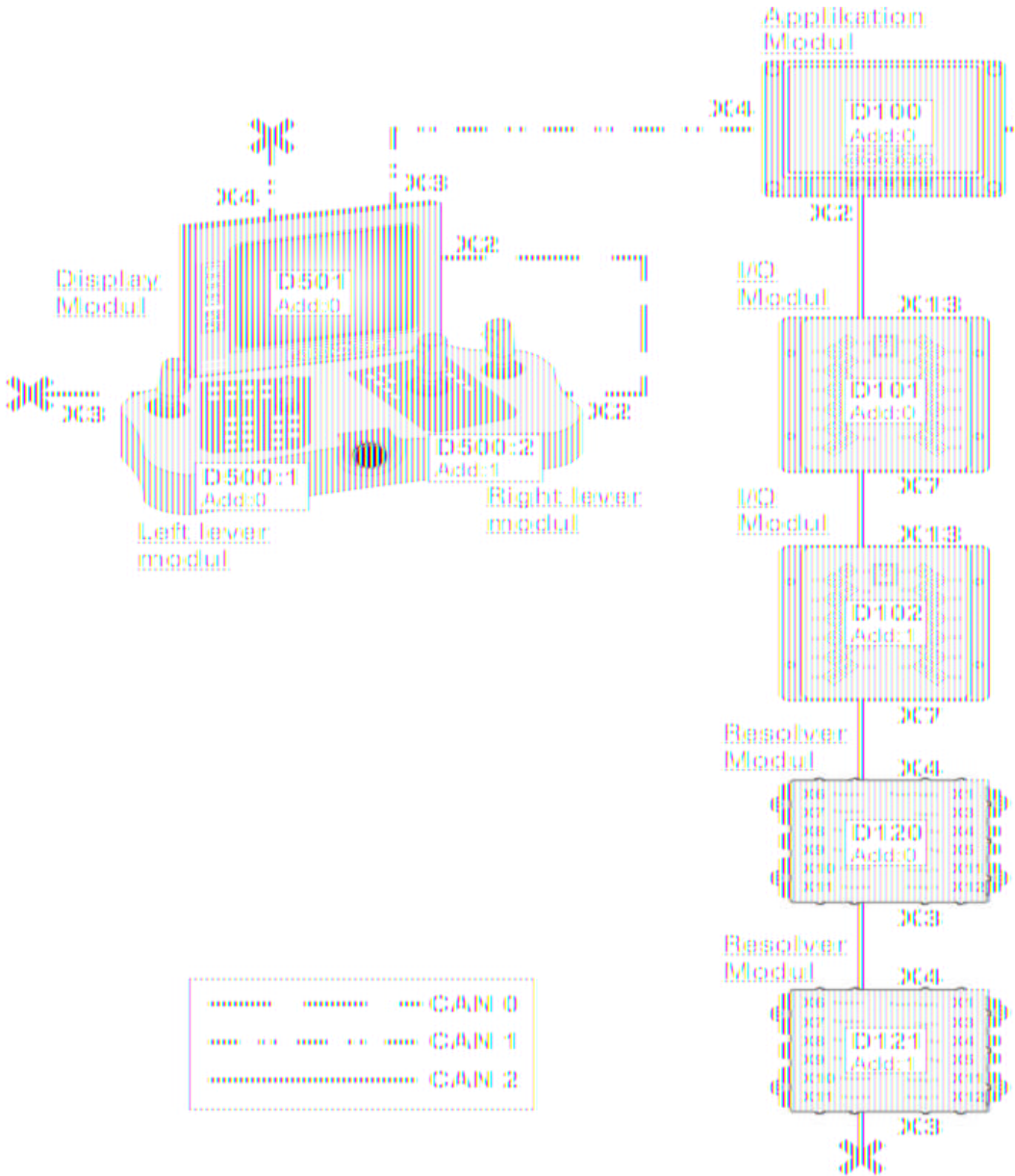

Modules

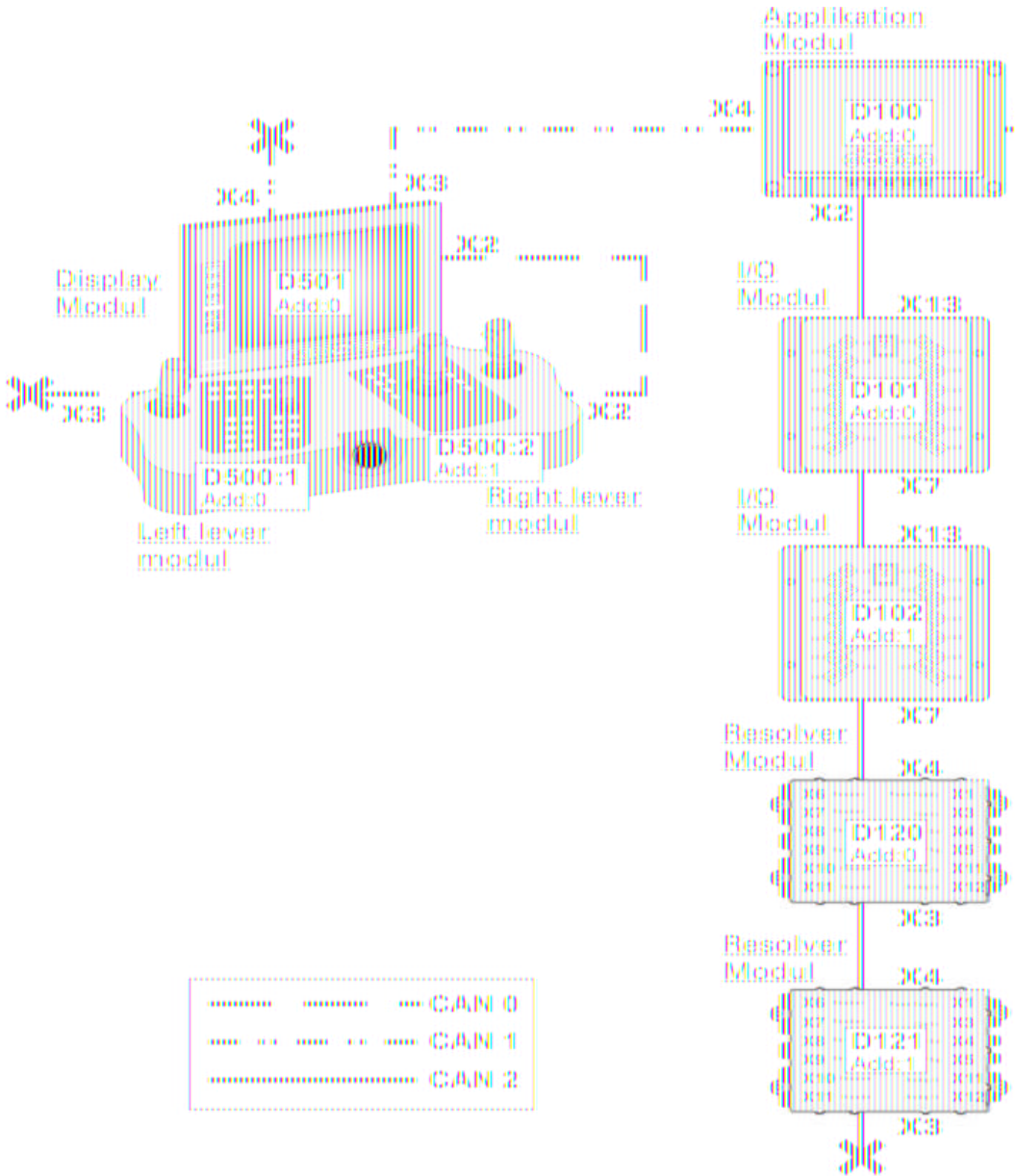

Modules

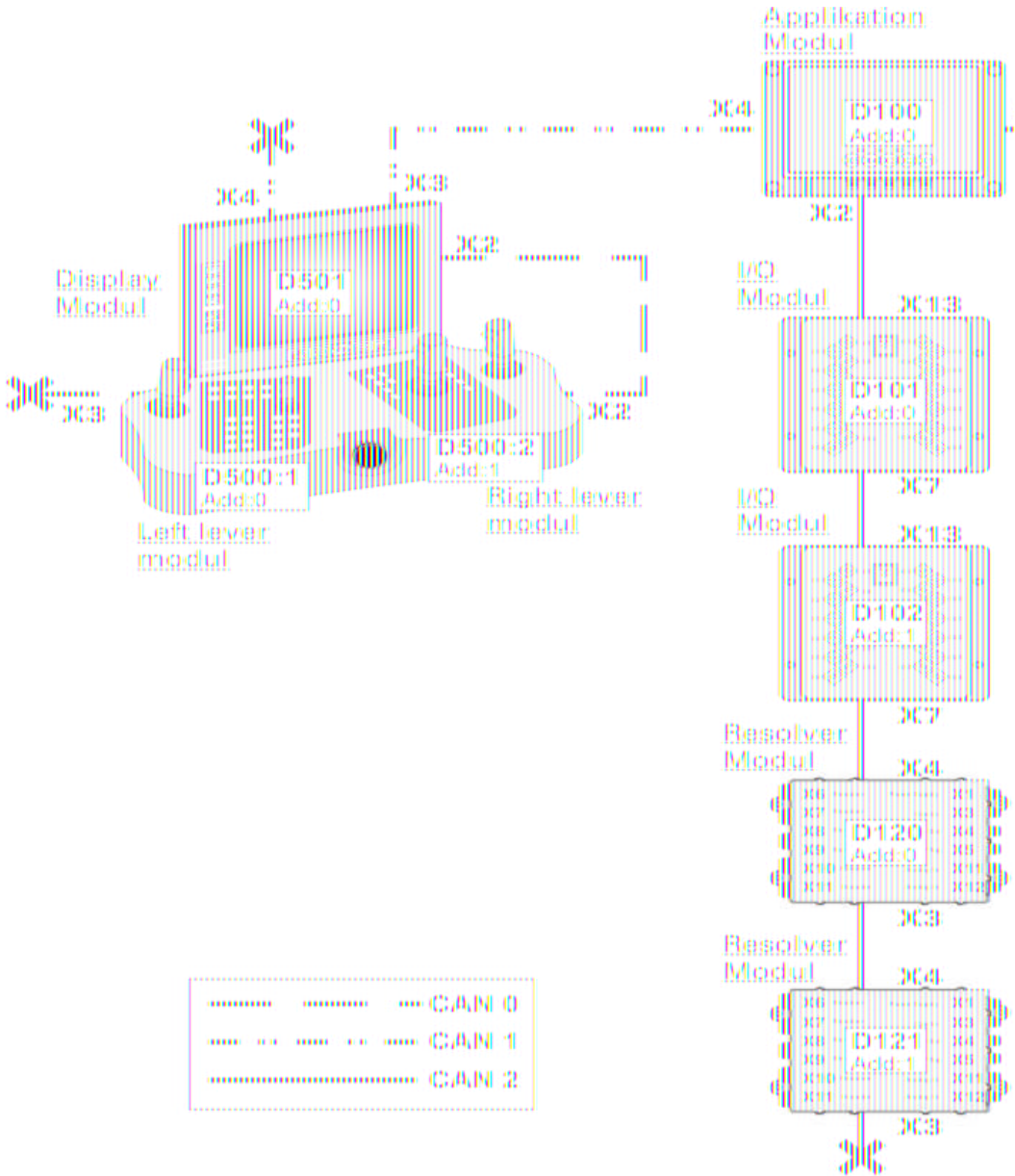

Modules

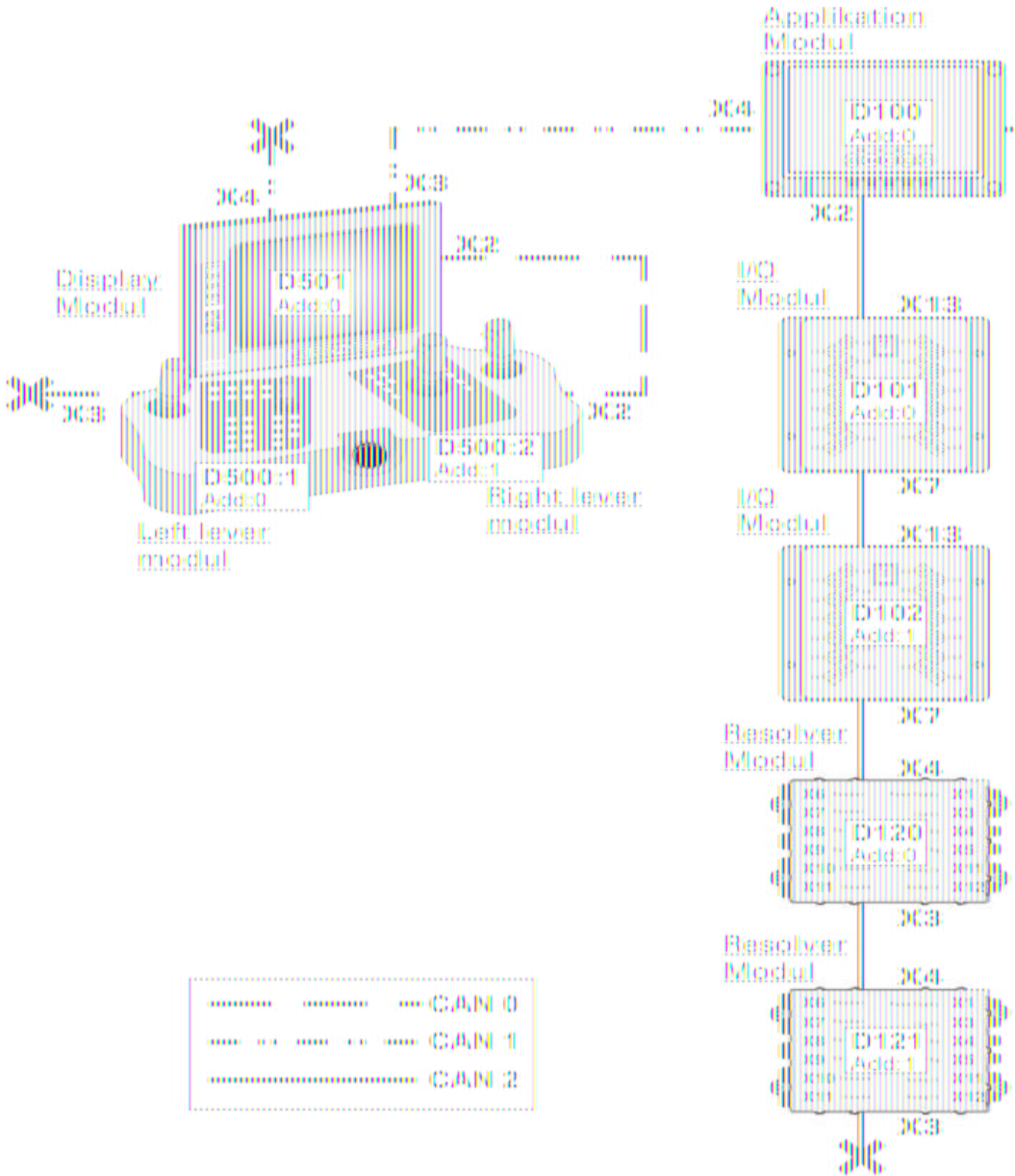

Upper CAN & Lower CAN

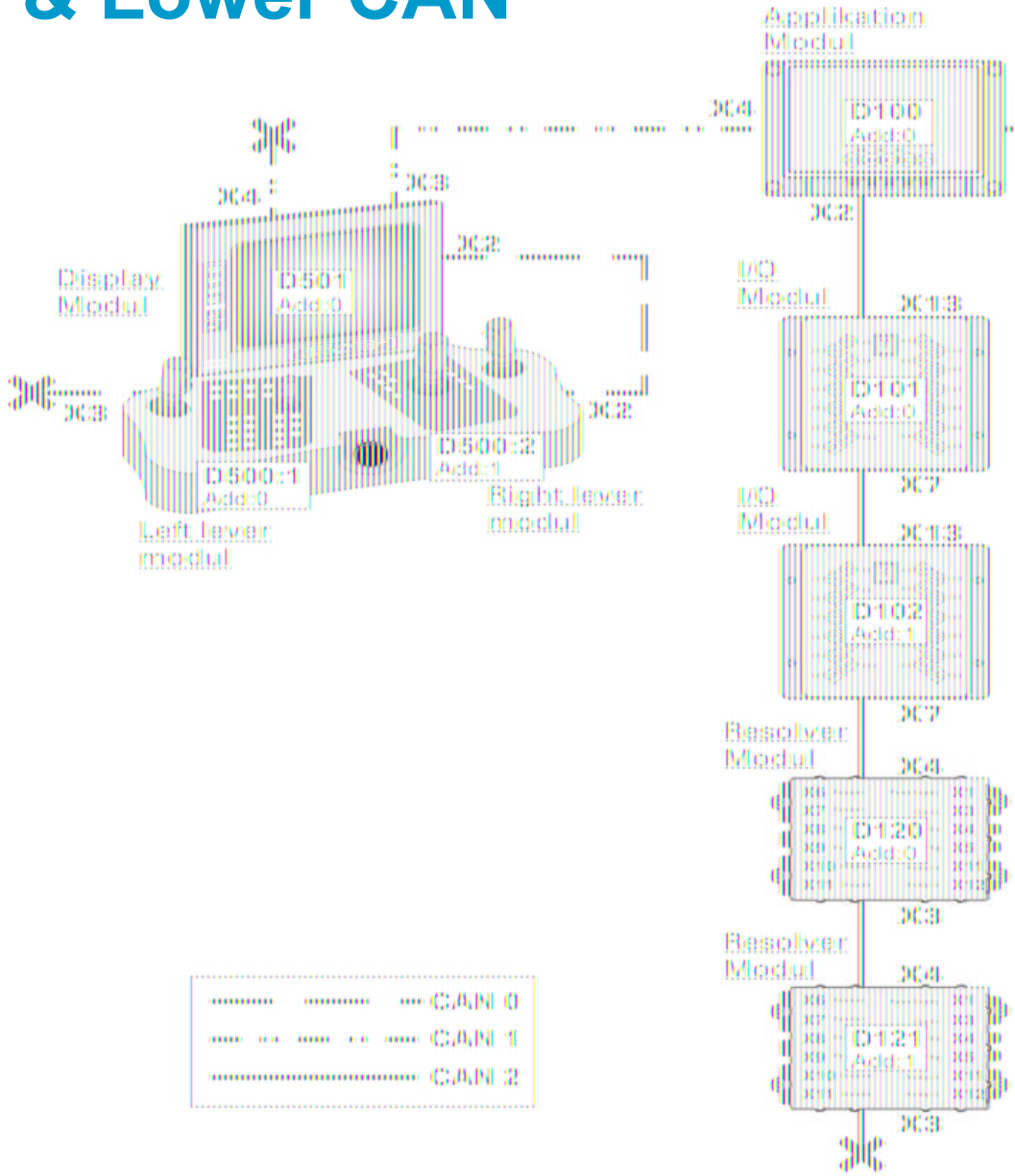

Upper CAN & Lower CAN

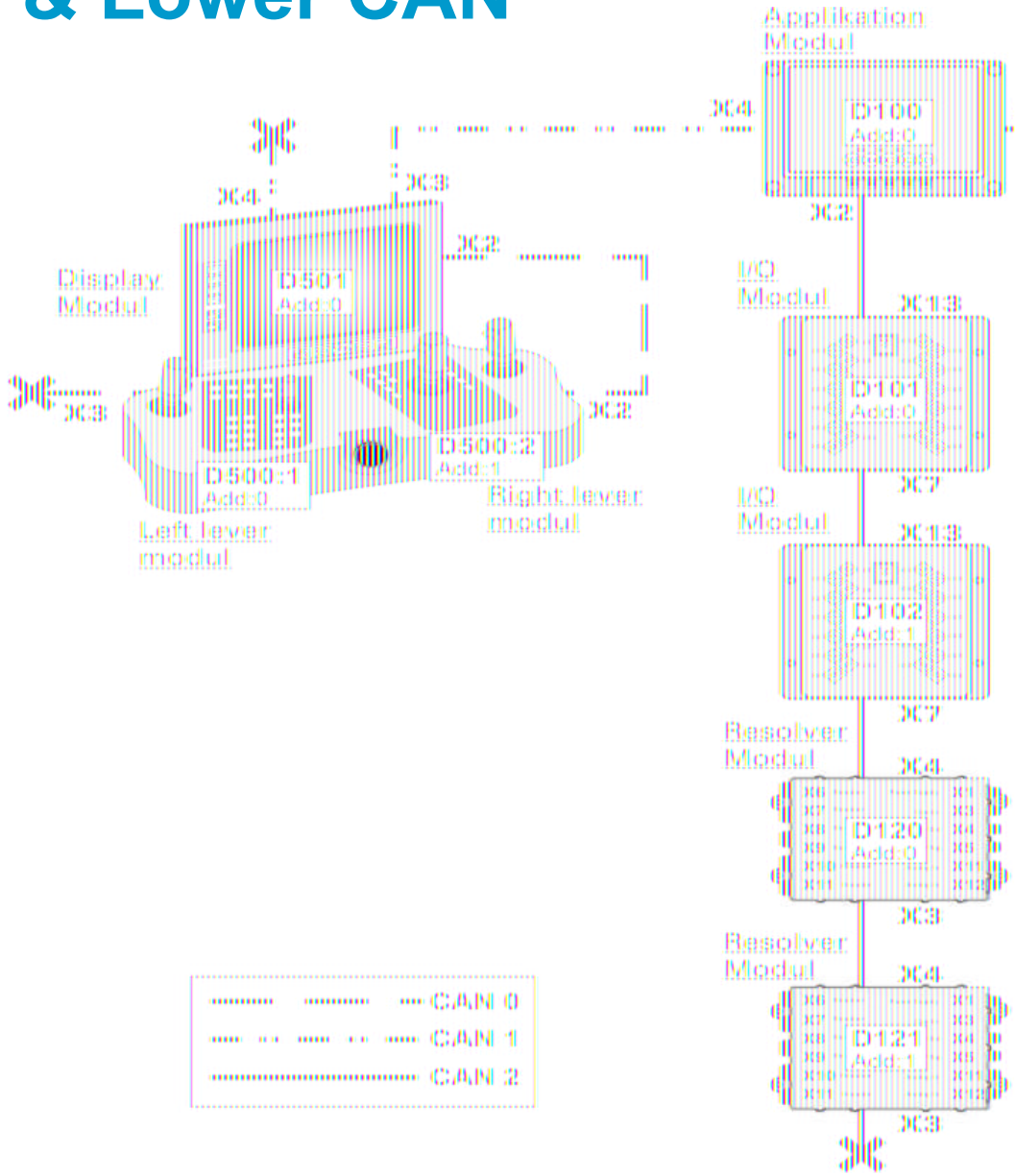

Terminating with end plugs

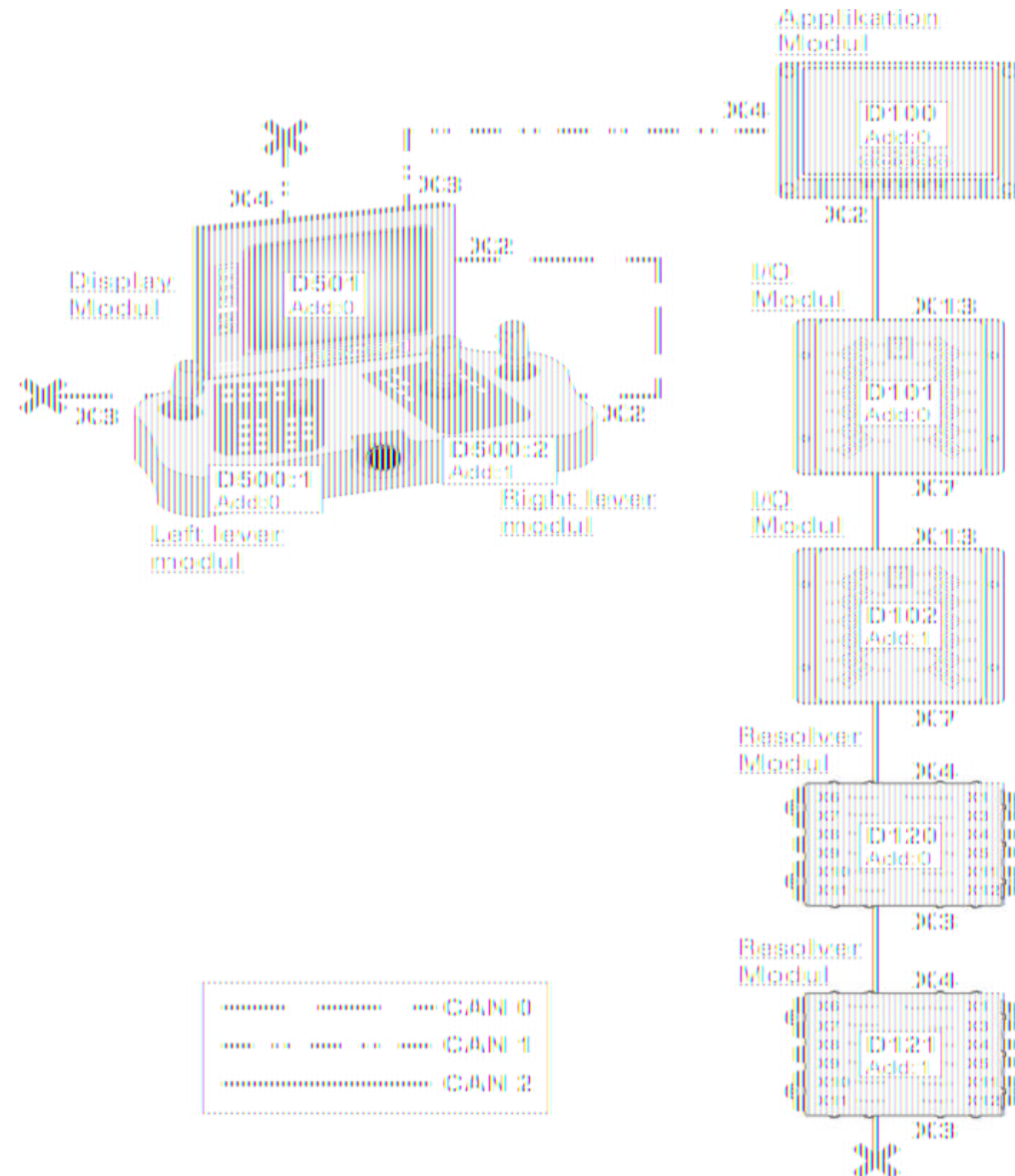

Plugs



Address plugs

- 0-9106 1324 90
- 1-9106 1324 91
- 2-9106 1324 92
- 3-9106 1324 93

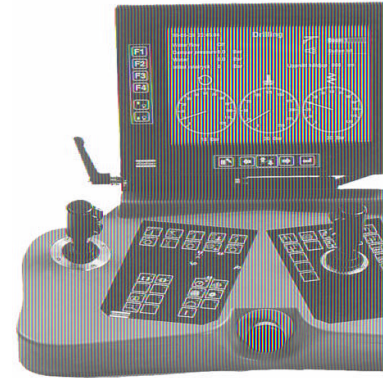

End plug (120 Ohm)

9106 1324 38

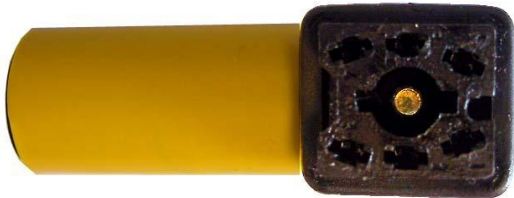

Address plugs

- 0-9106 1324 30
- 1-9106 1324 31
- 2-9106 1324 32
- 3-9106 1324 33



End plug (120 Ohm)

9106 0968 00

Addresses

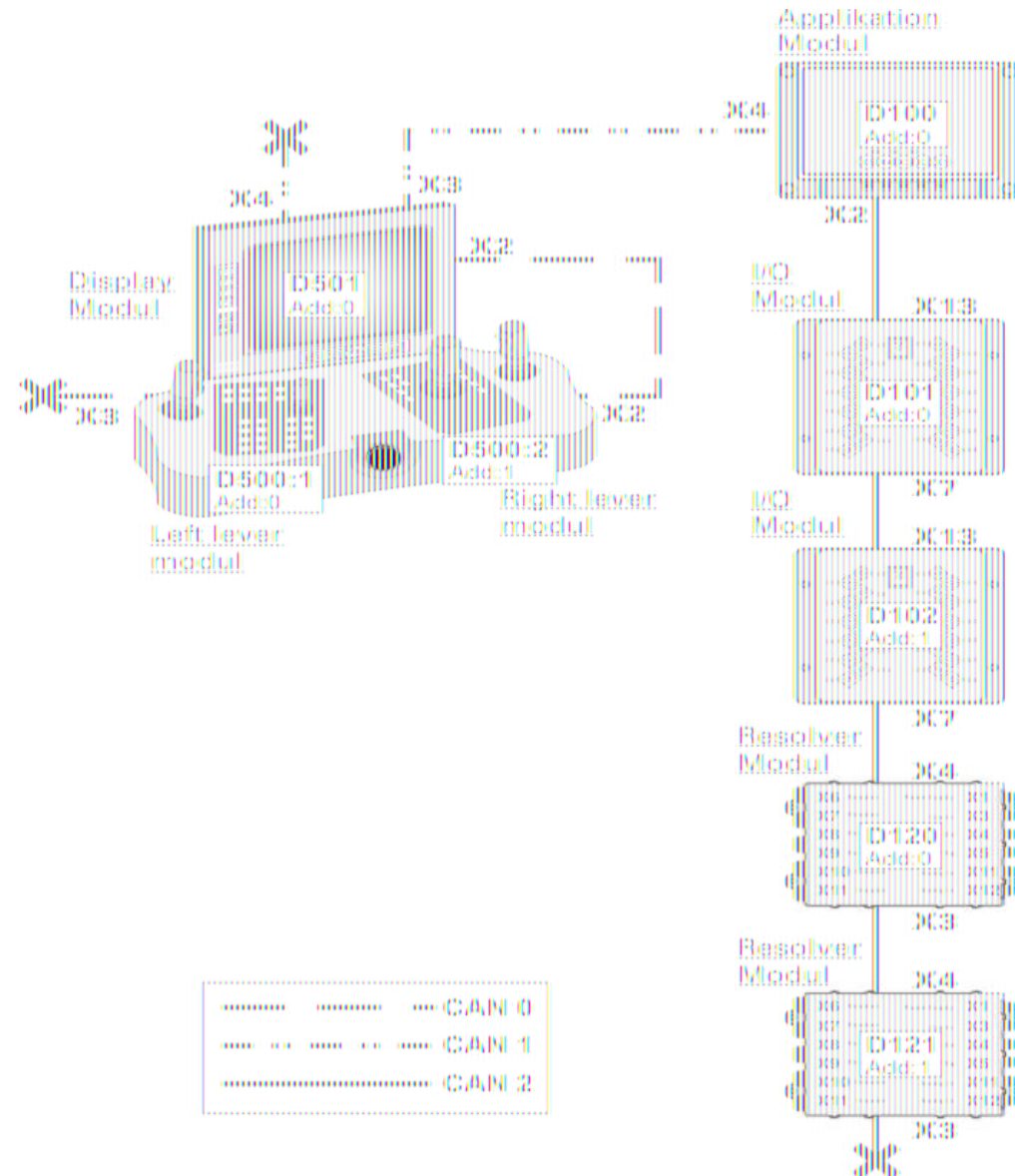

Operators panel

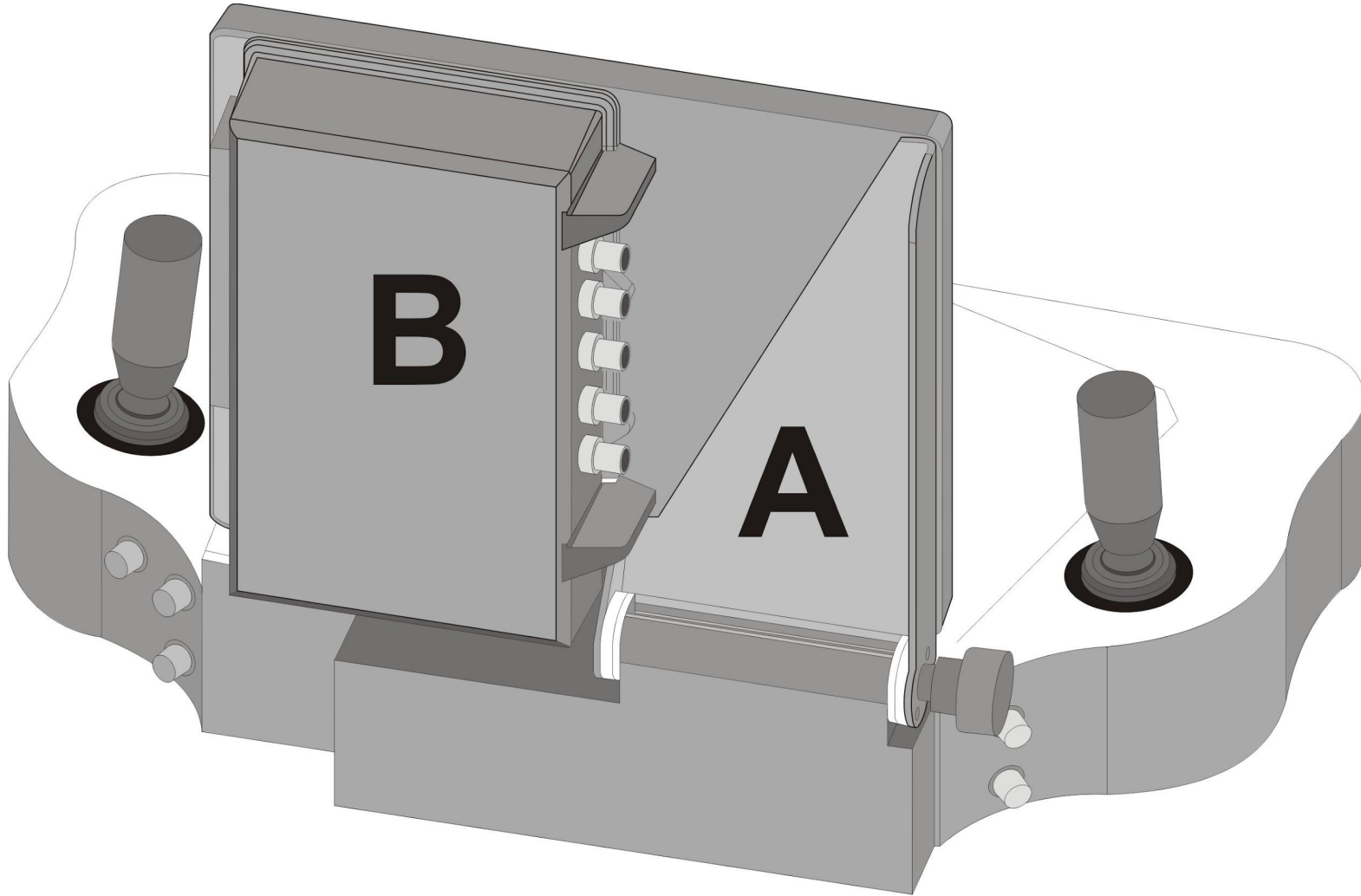

Operators panel

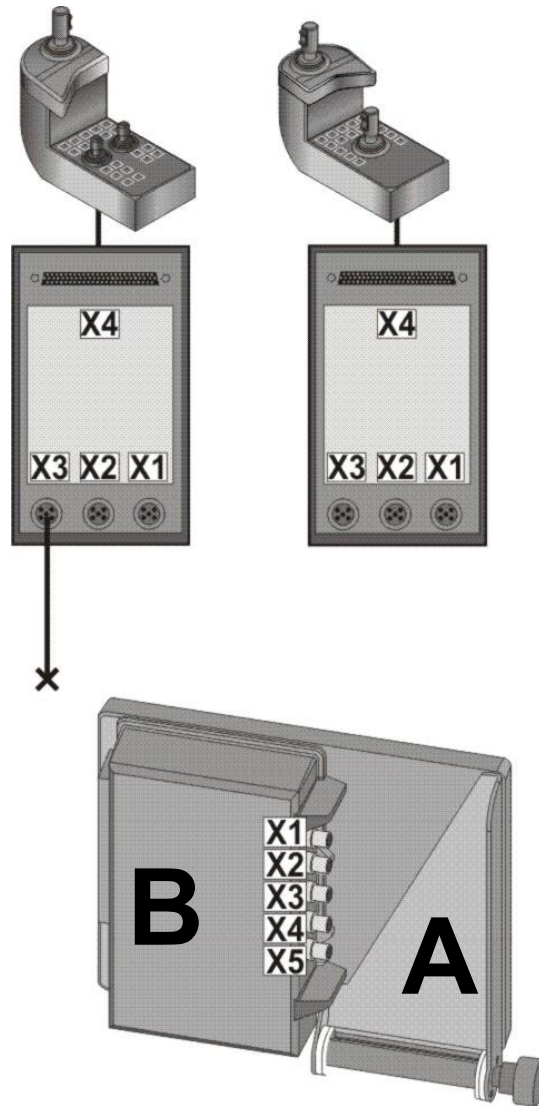

Application module



Application module

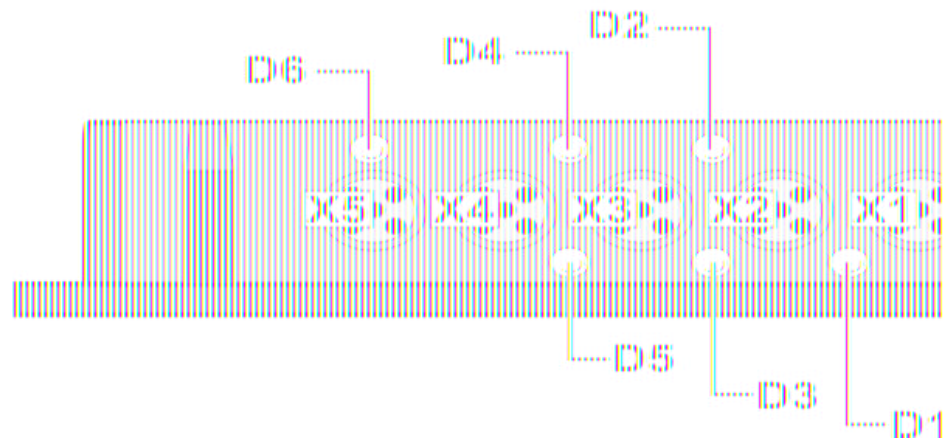
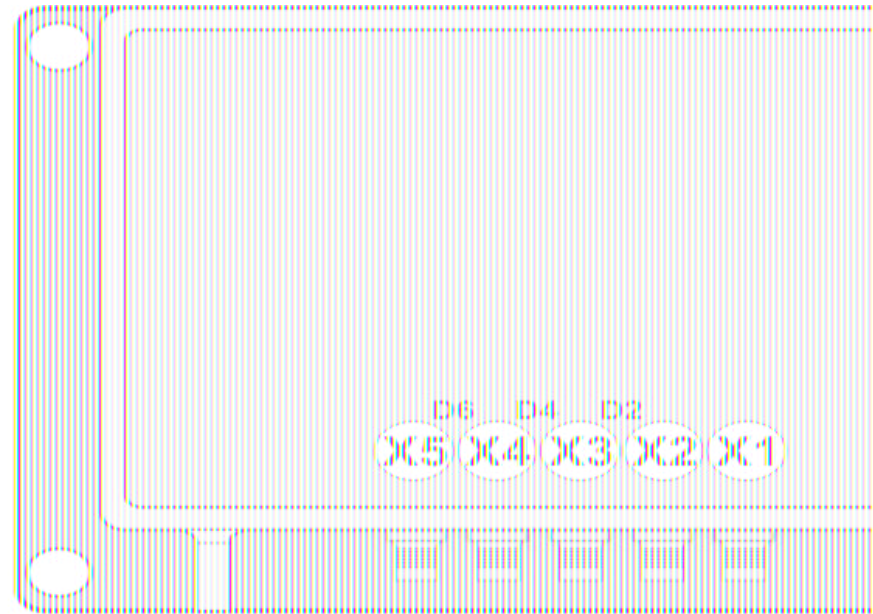

I/O Module

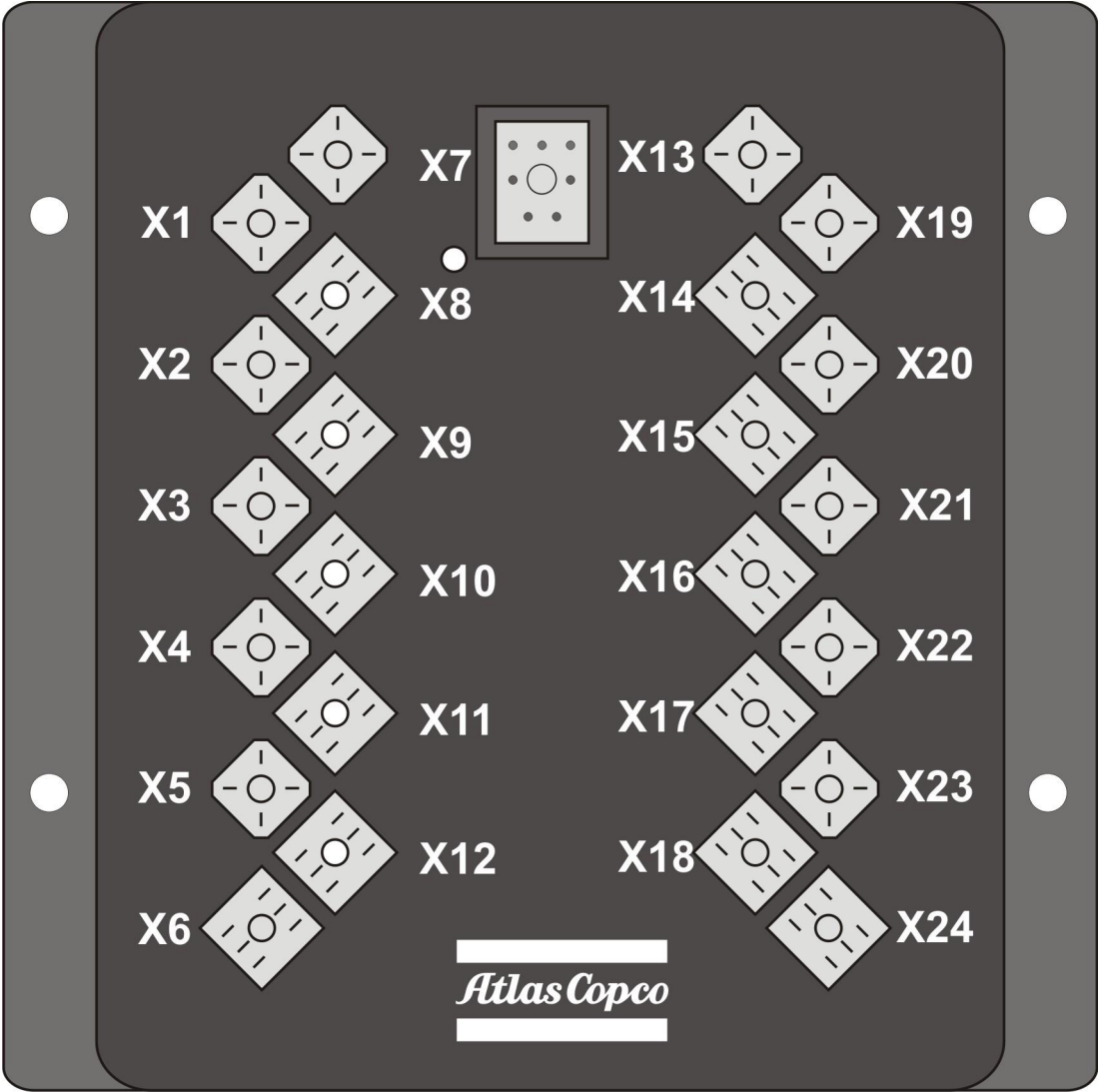

I/O Module

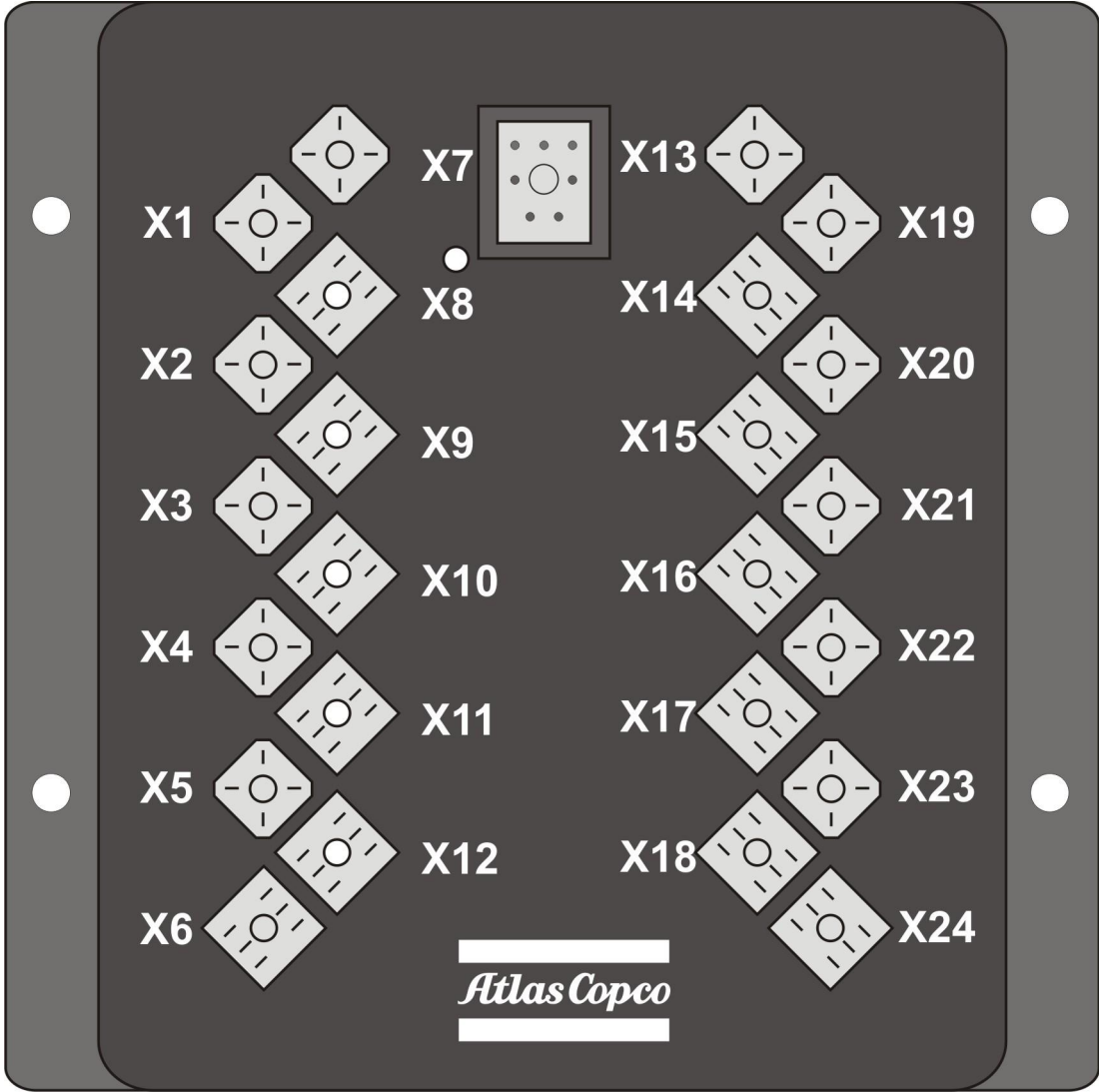

I/O Module

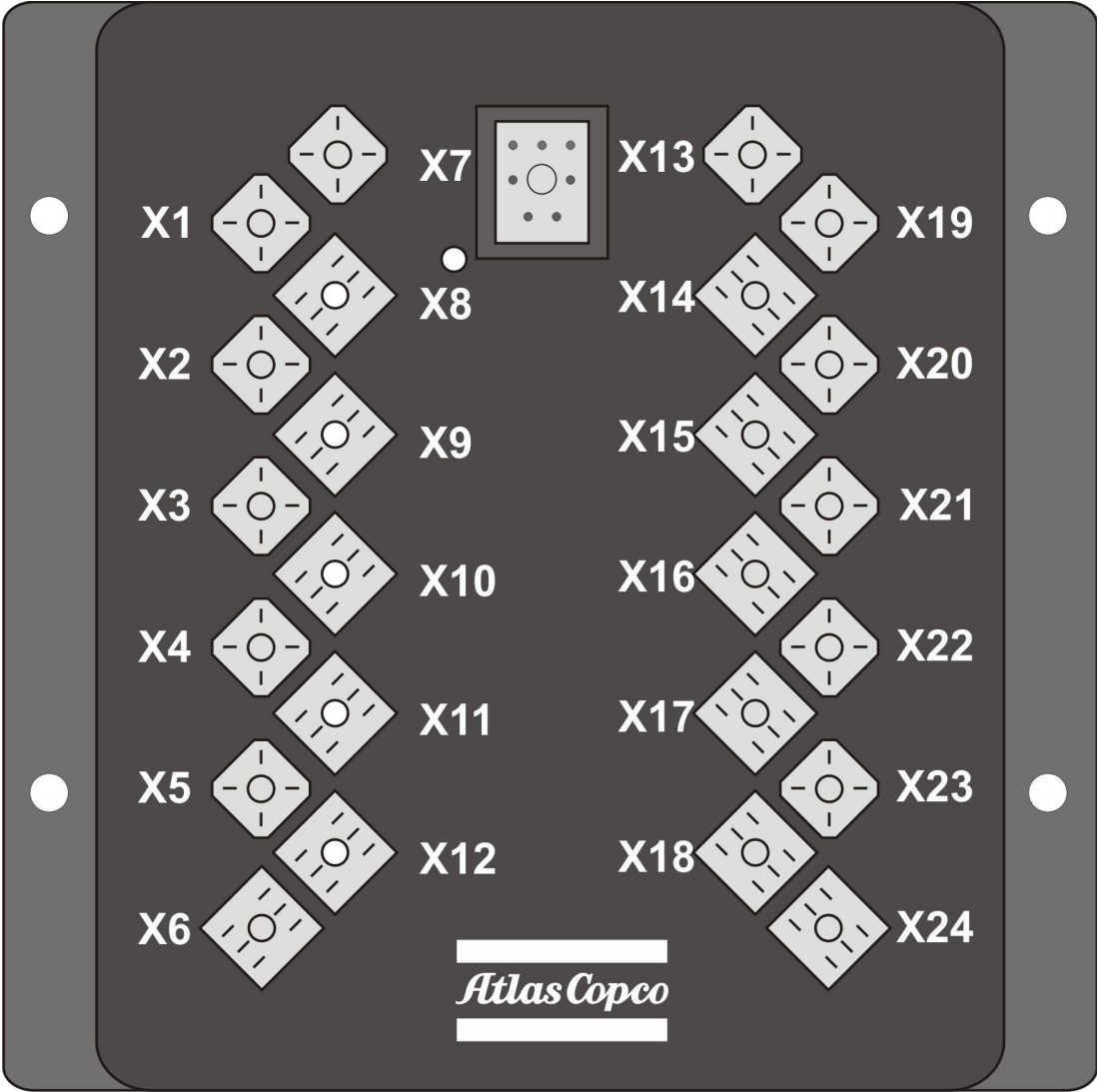

Resolver module



Power supply

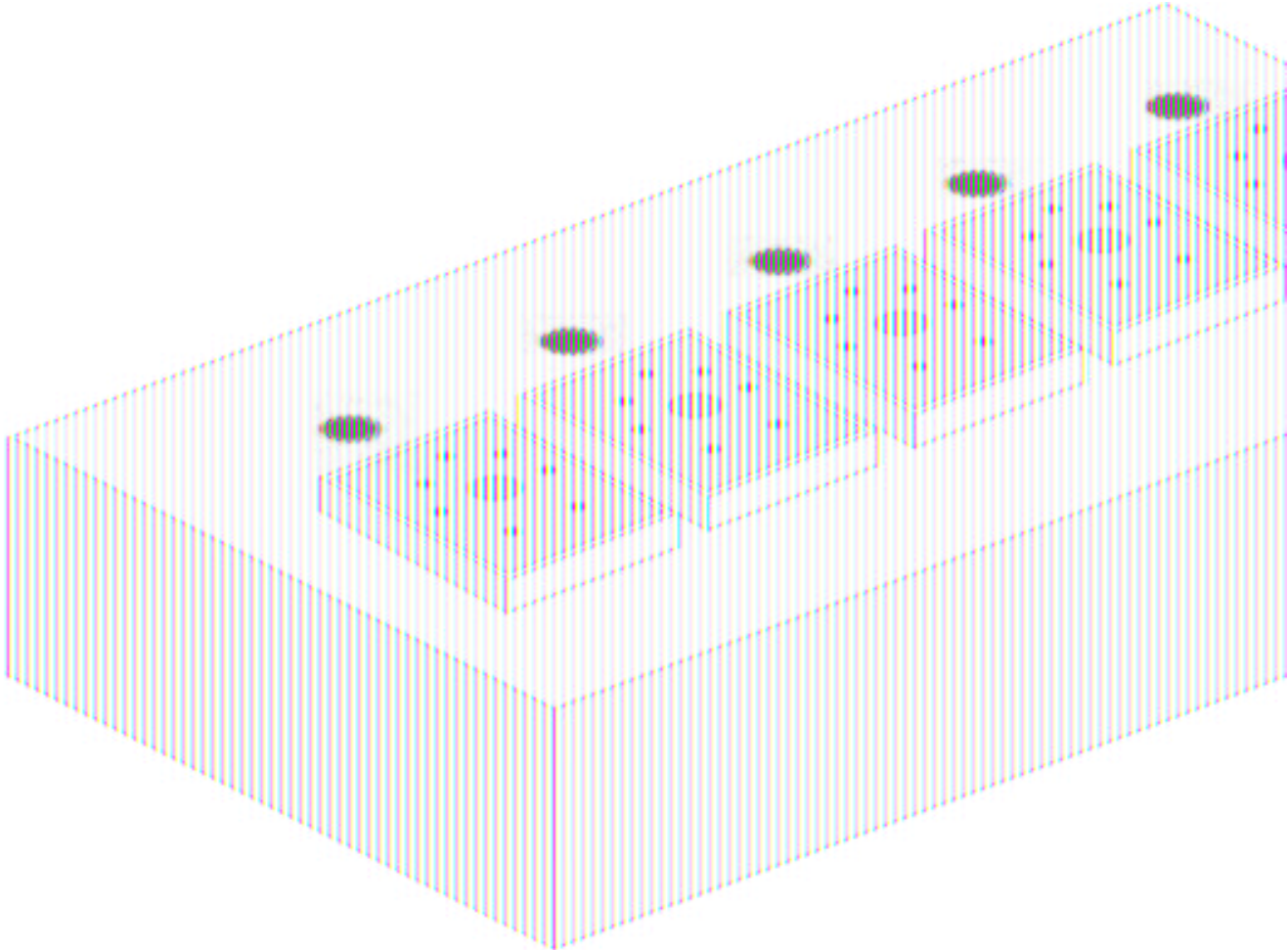

Correct answers

Correct answers

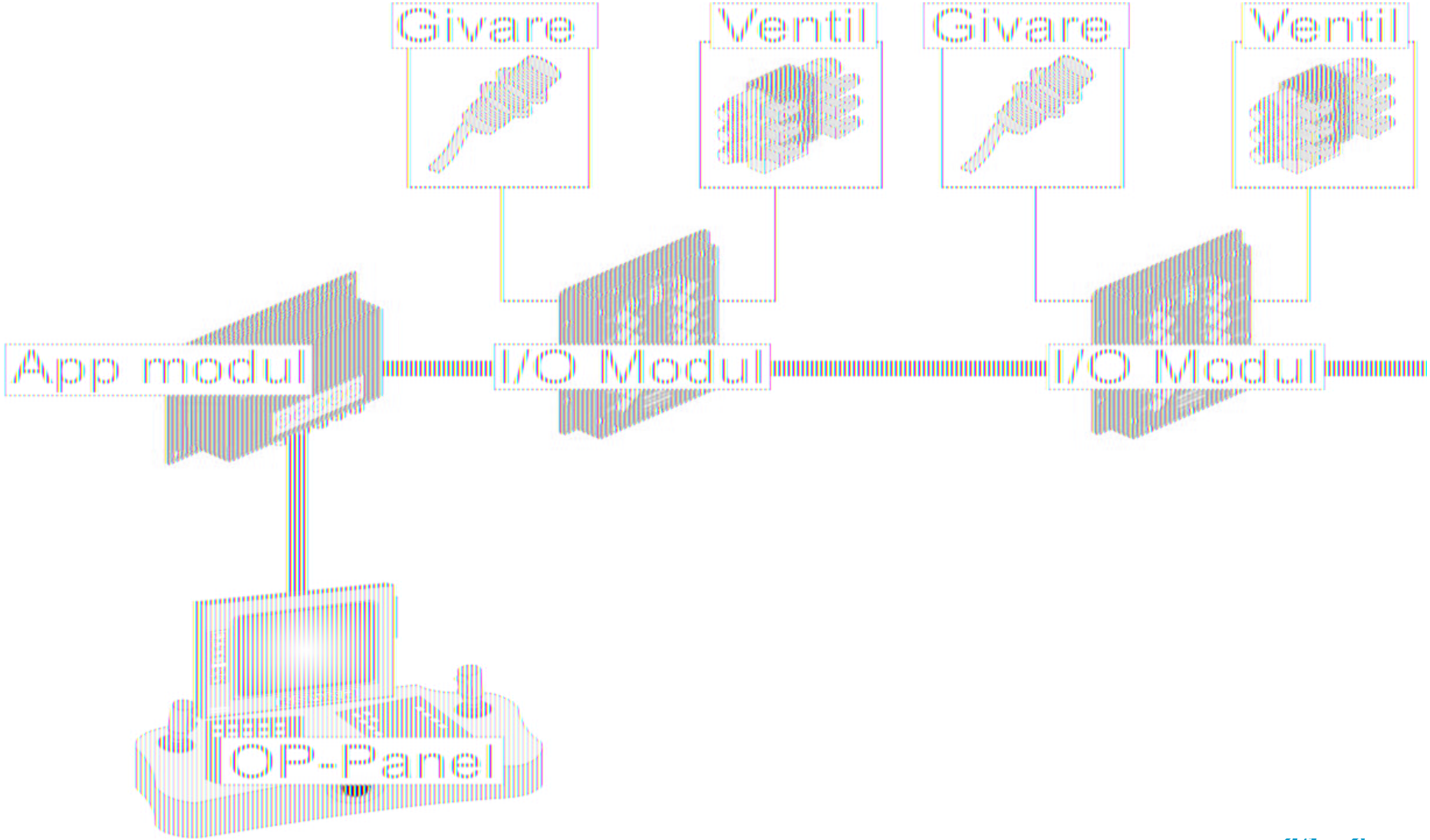

Modules

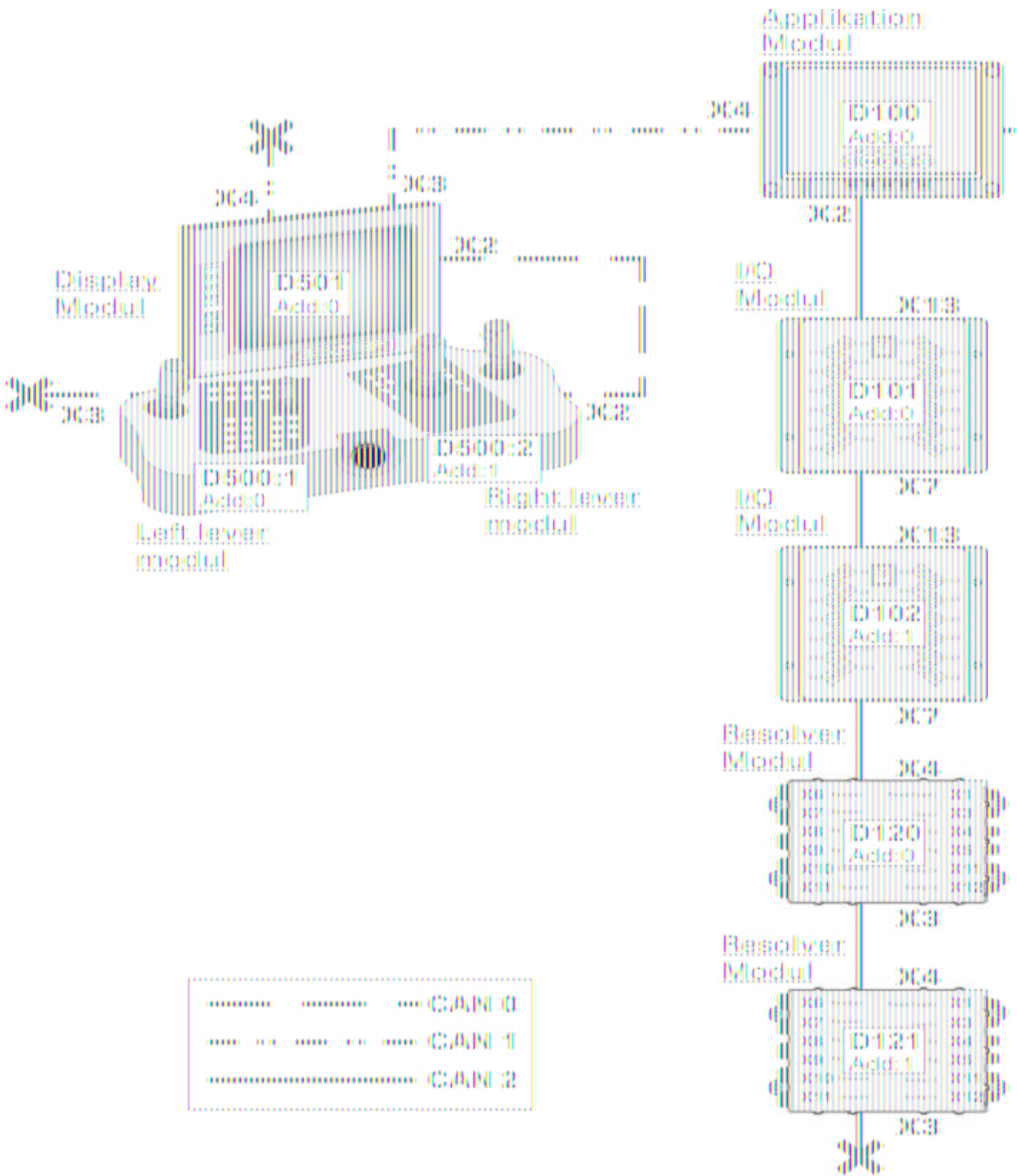

Modules

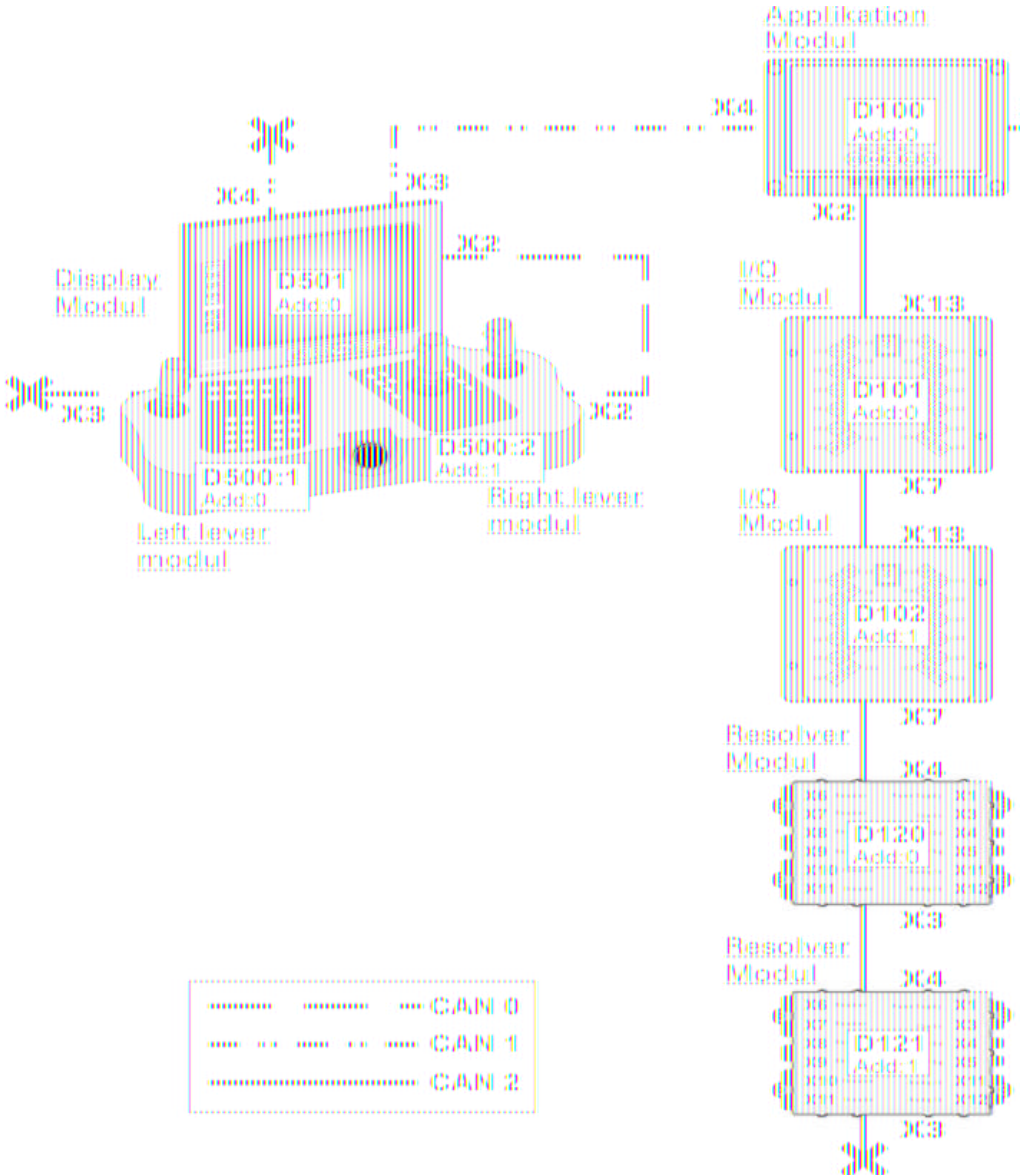

Modules

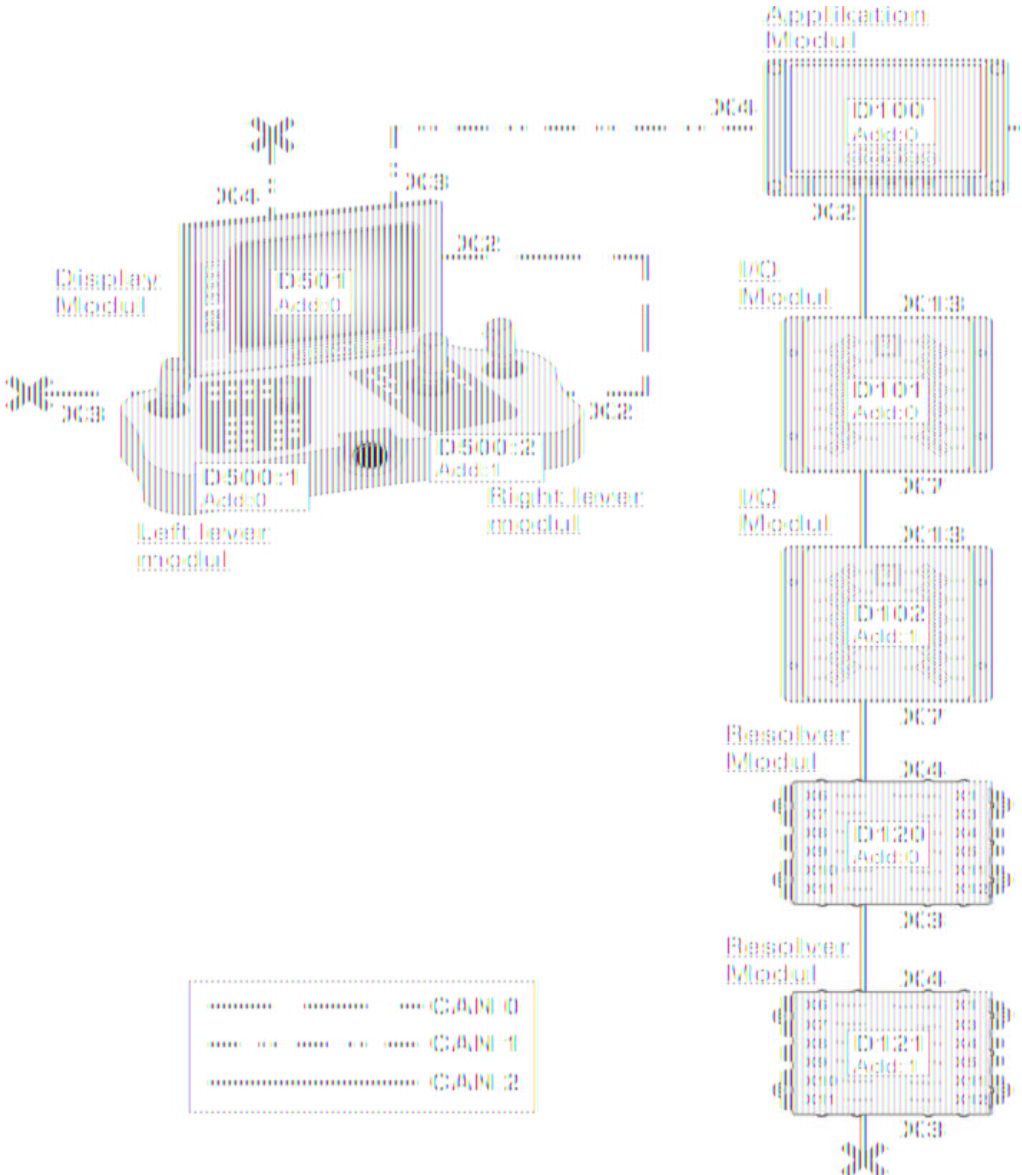

Modules

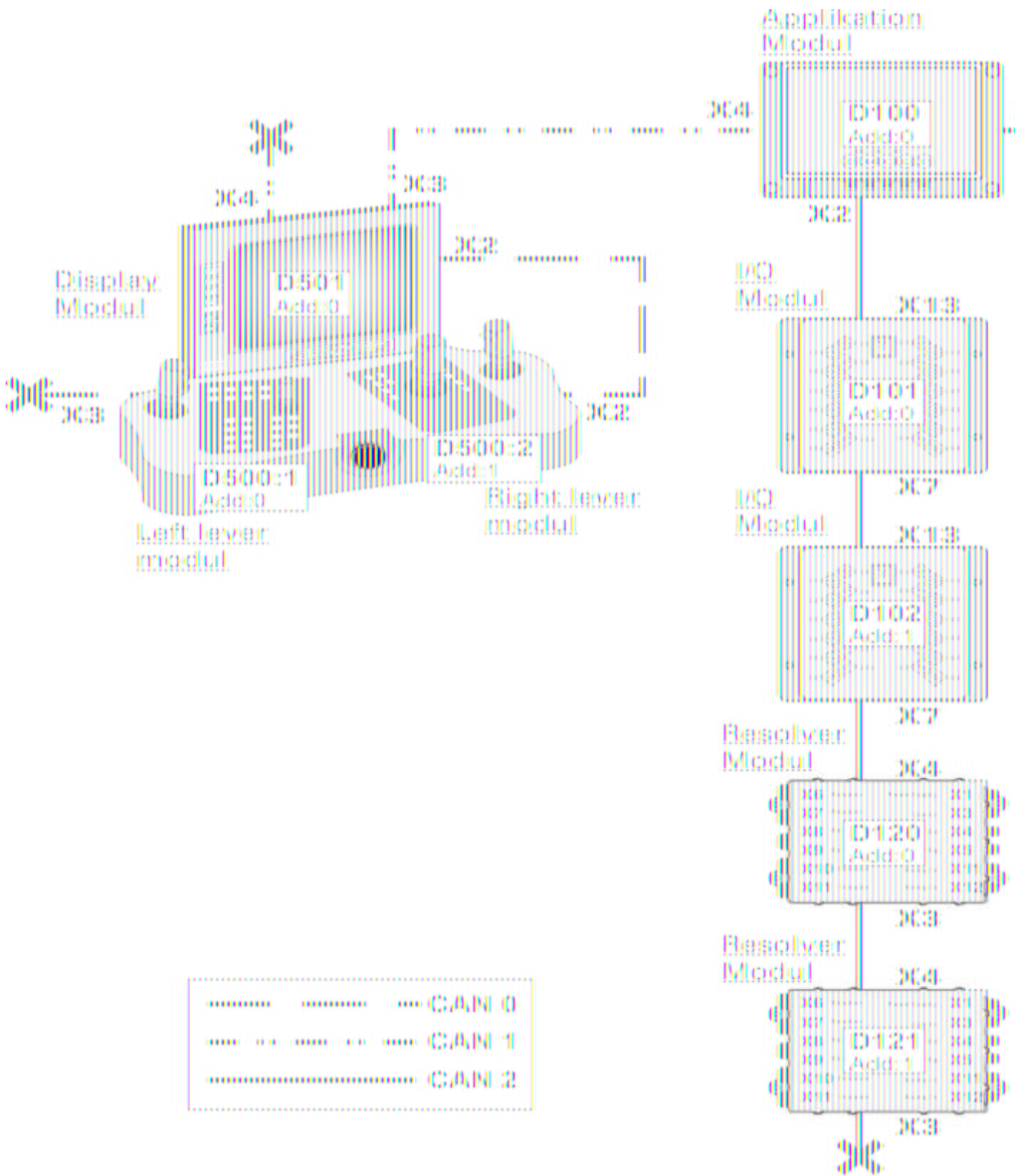

Modules

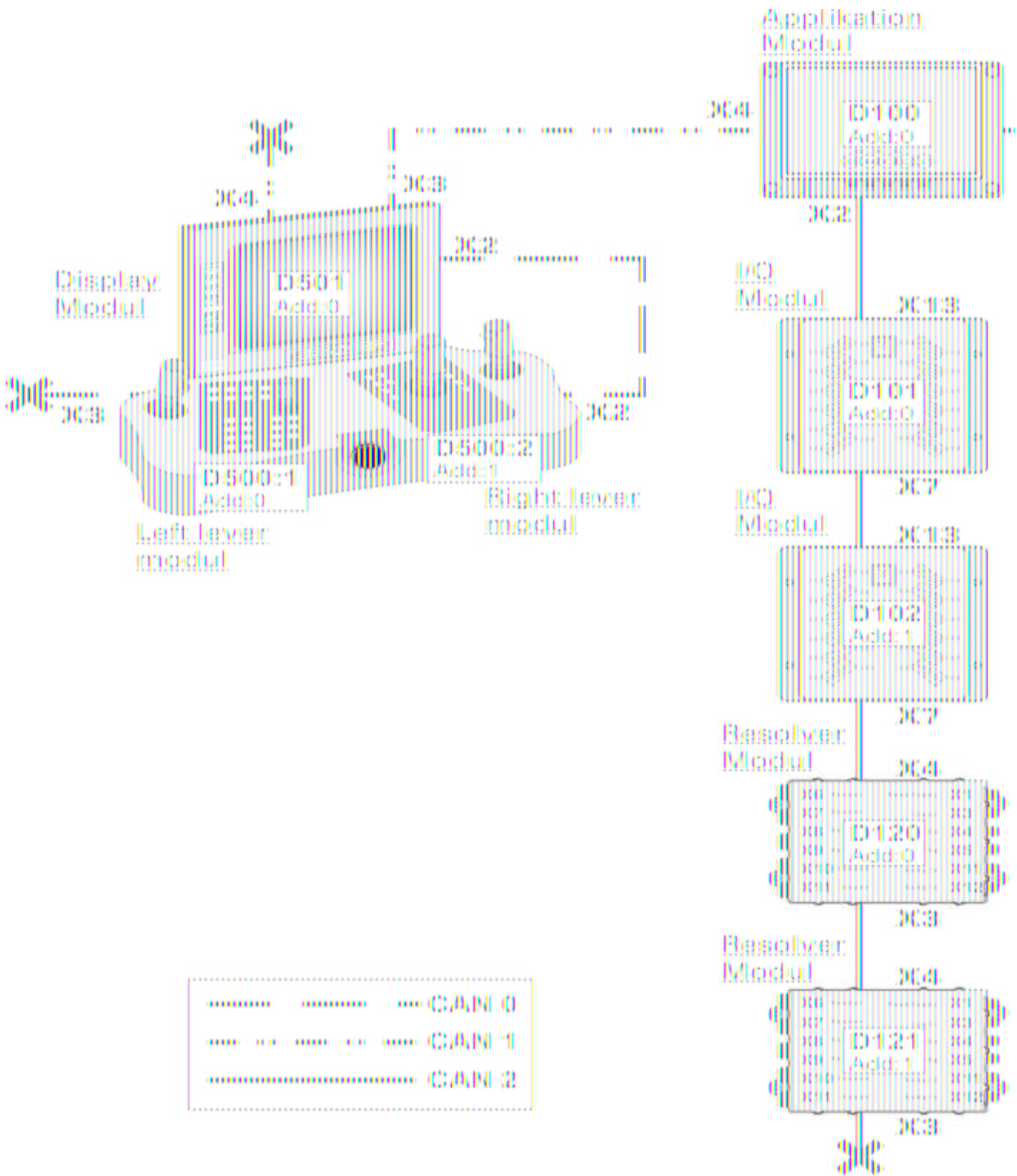

Modules

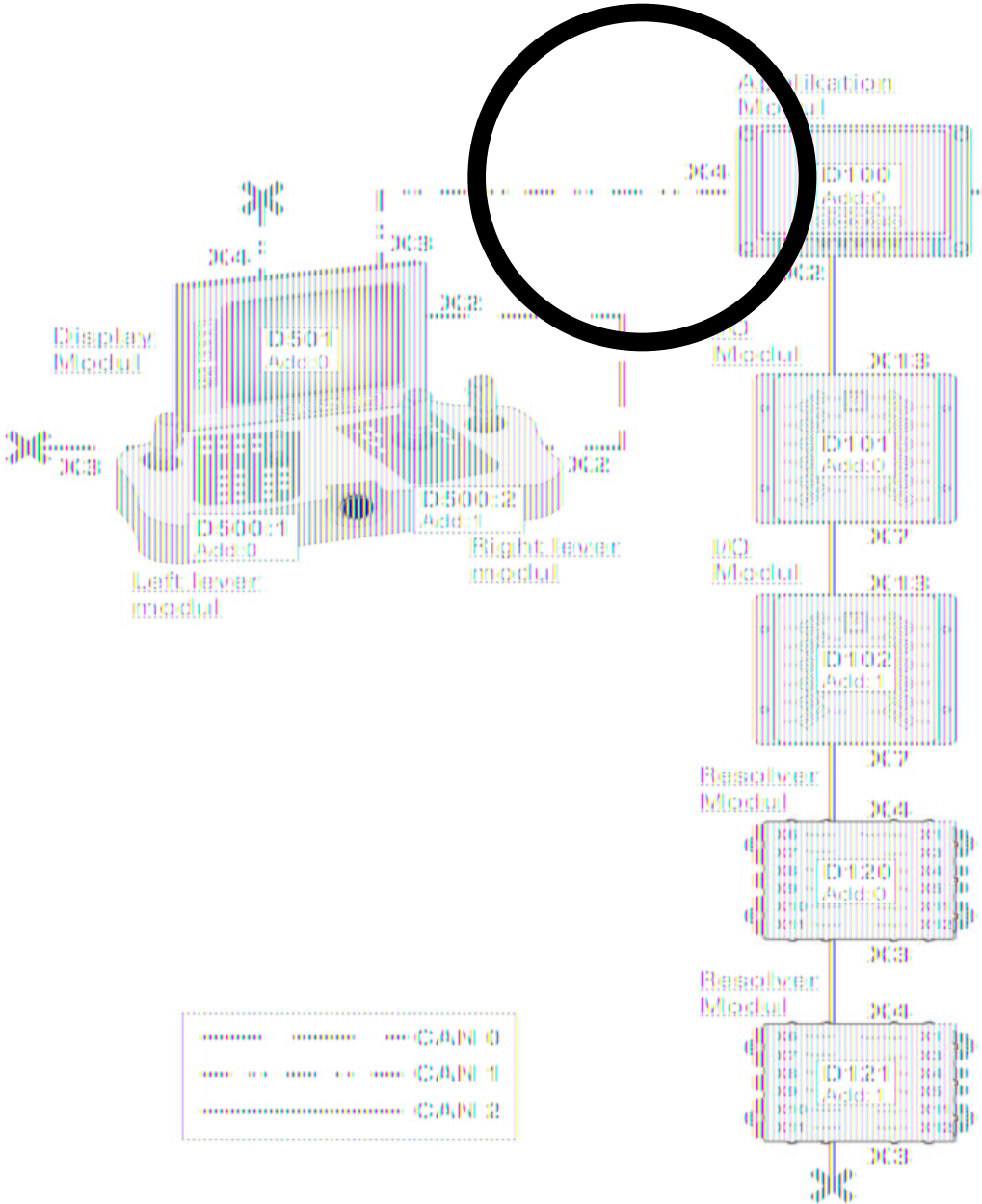

CAN 1 and CAN 2

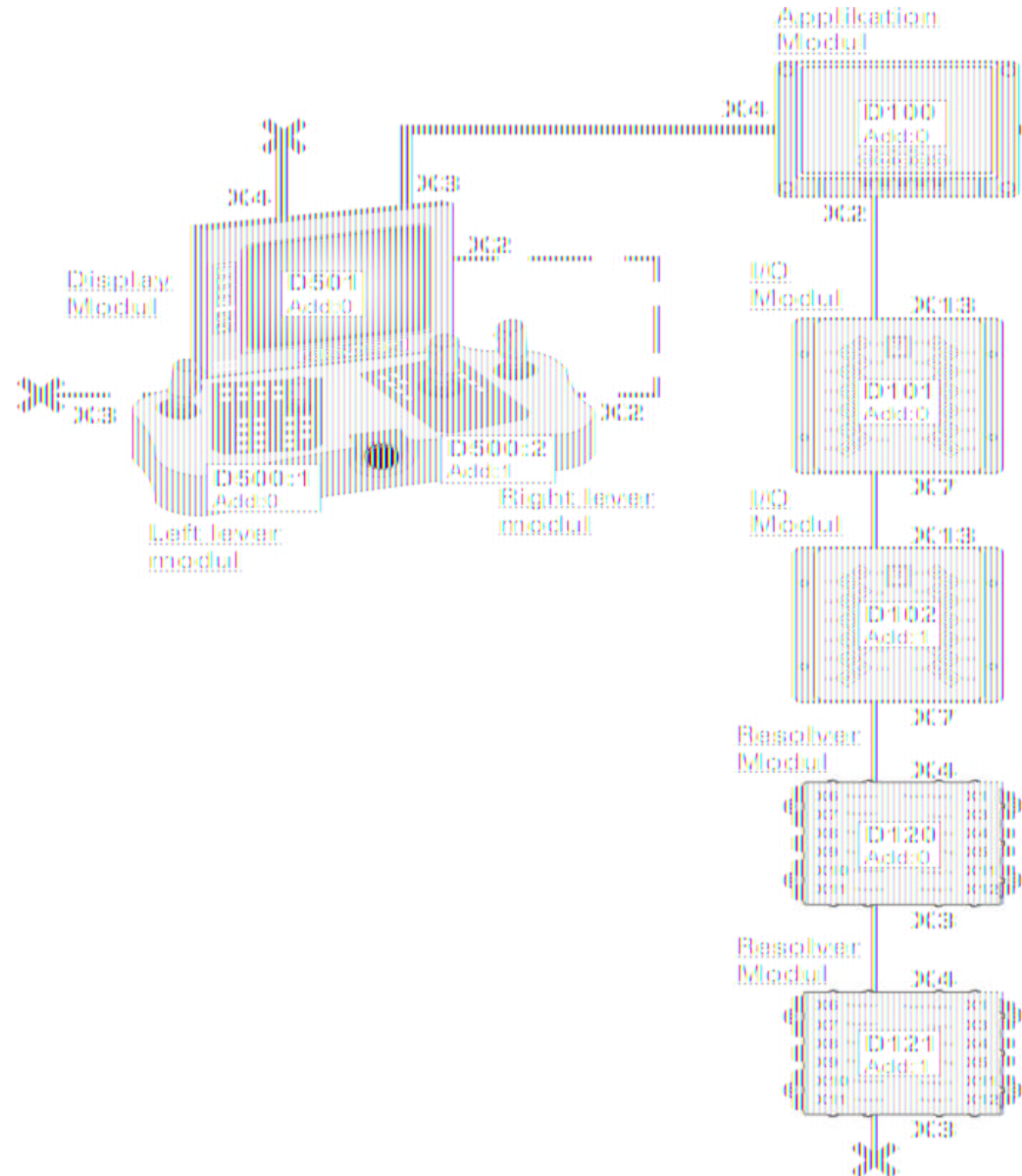

Terminating with end plugs

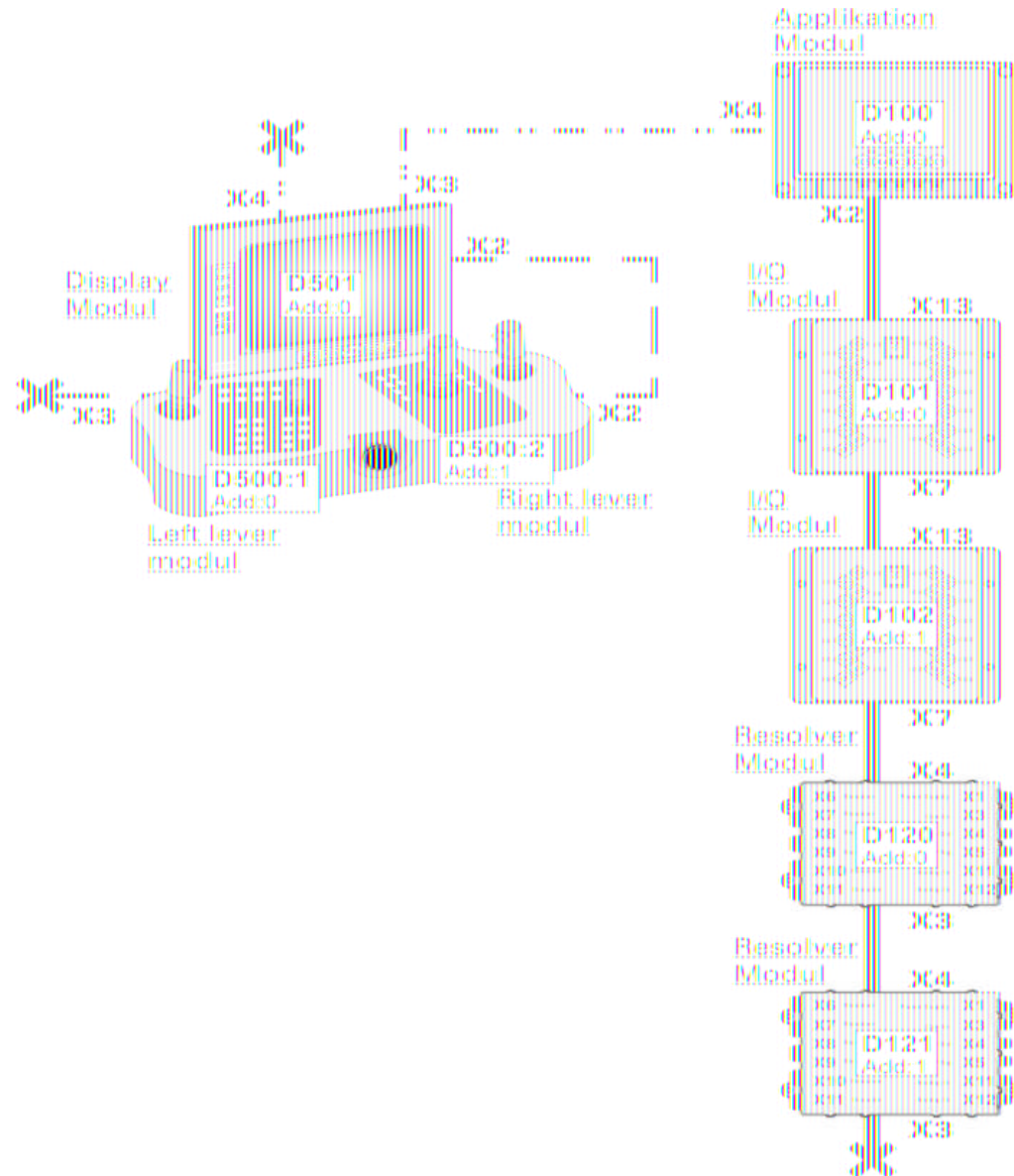

Terminating with end plugs

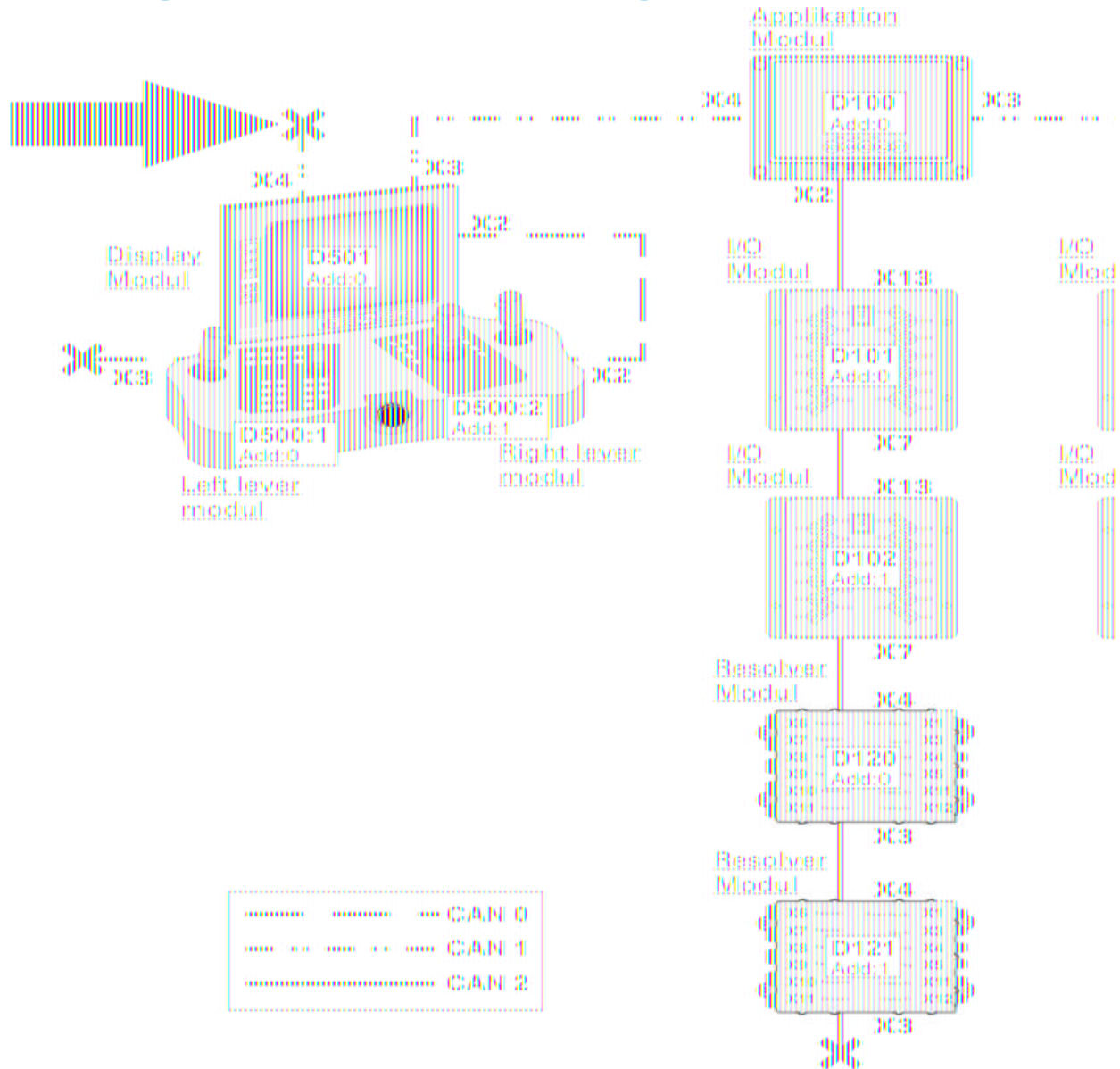

Terminating with end plugs

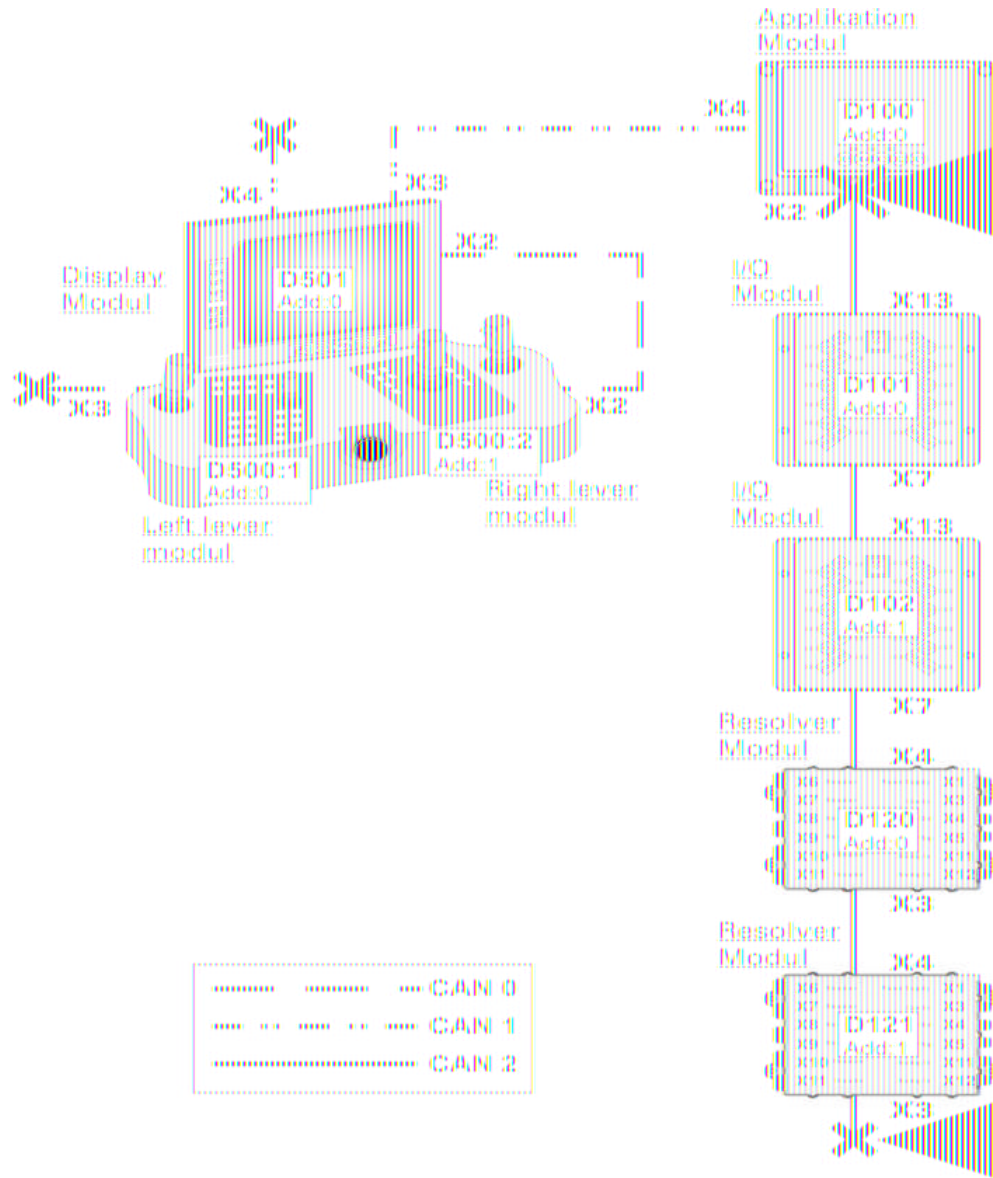

Addresses

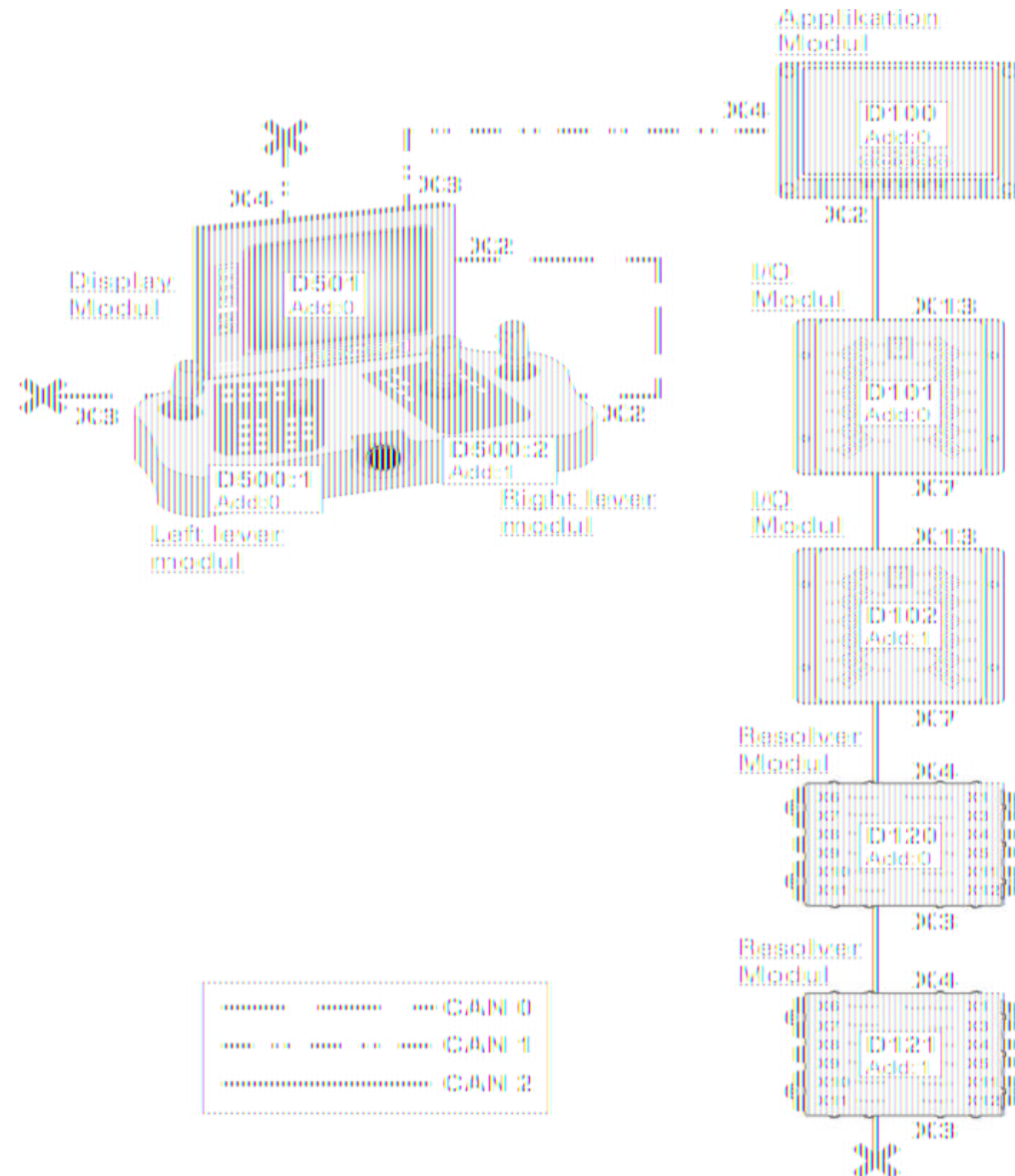

Addresses

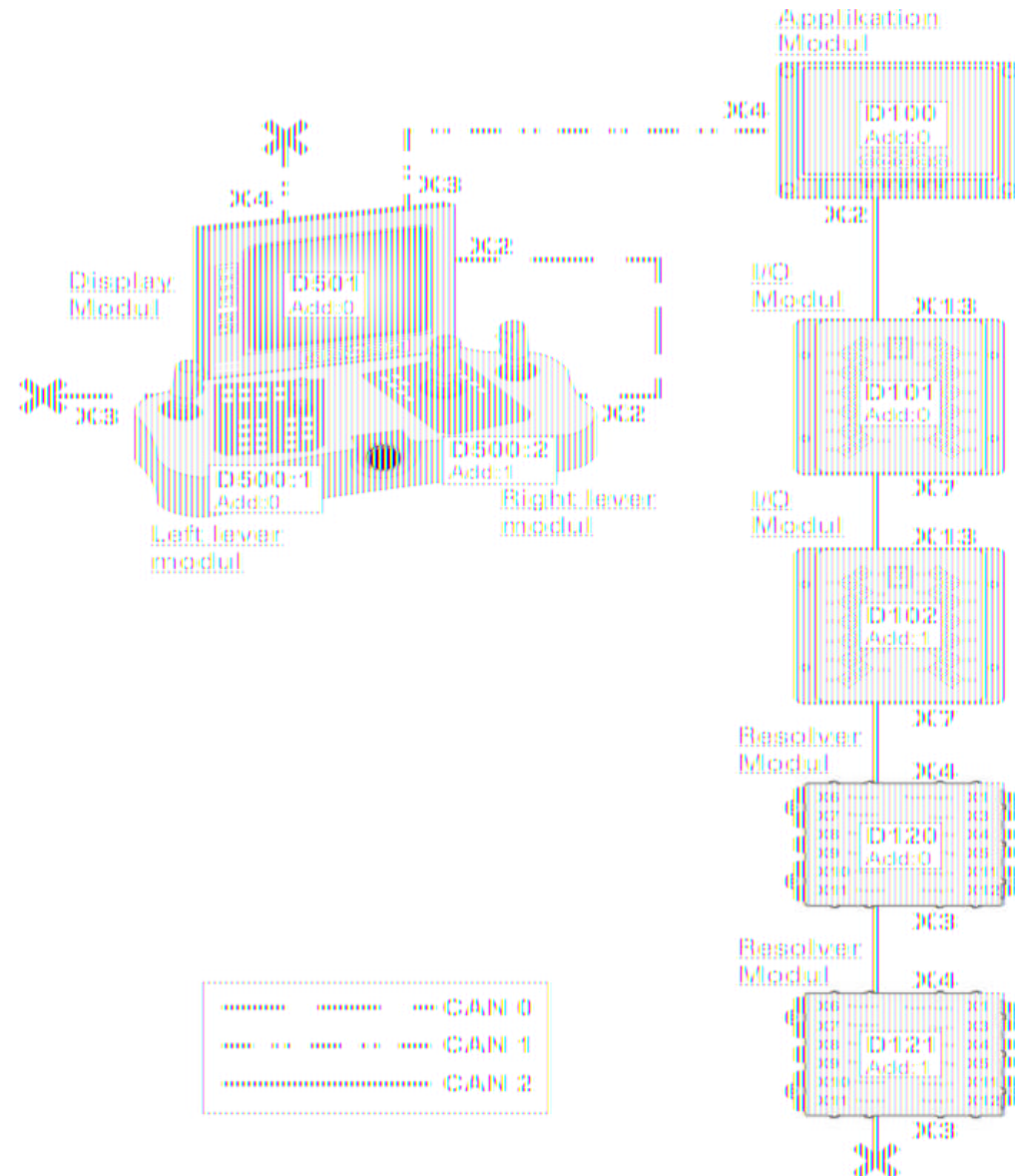

Operators panel

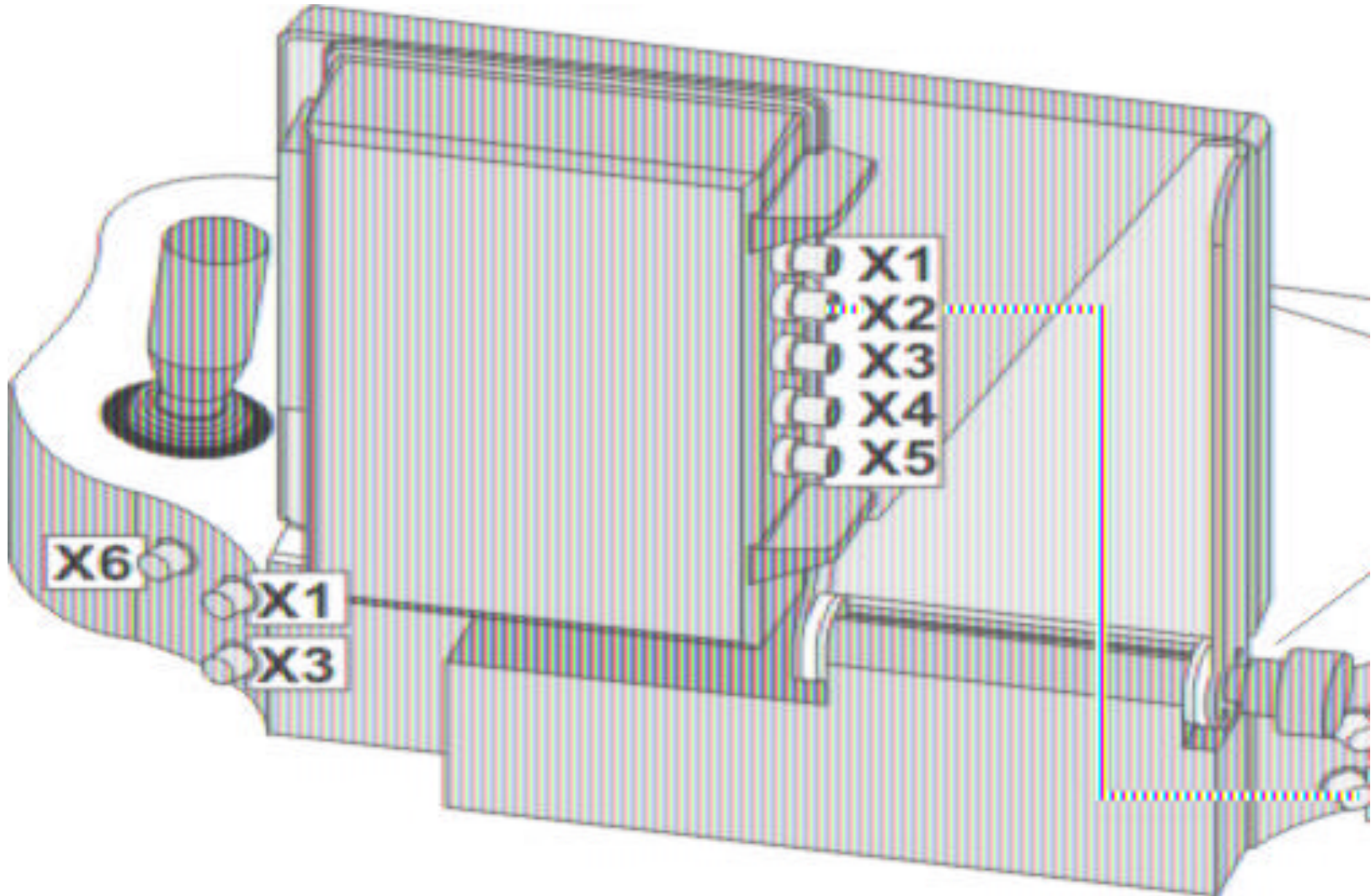

Operators panel

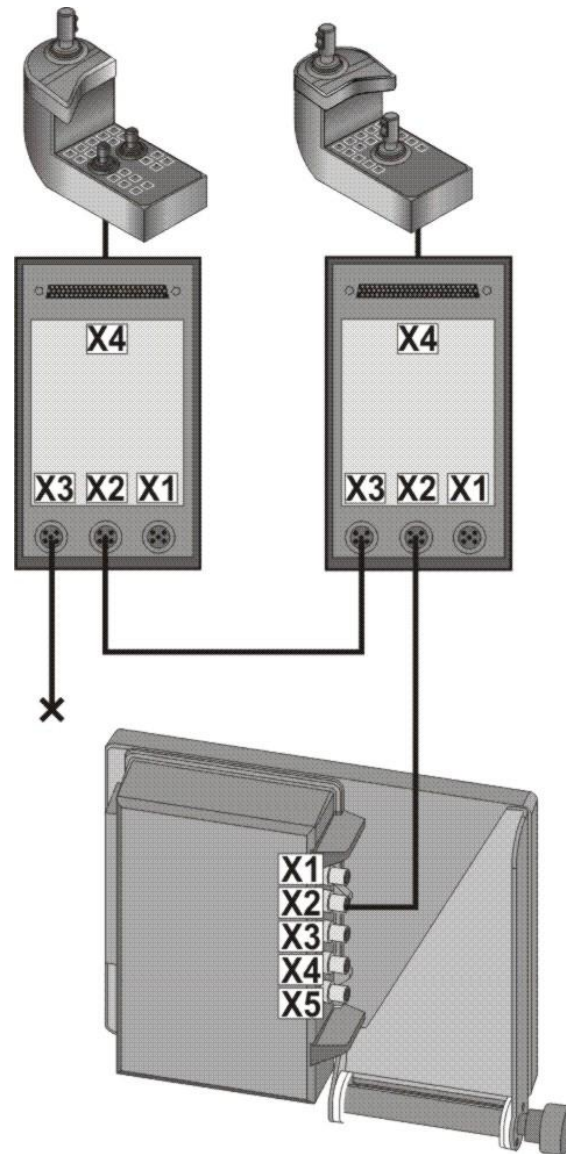

Application module



I/O Module

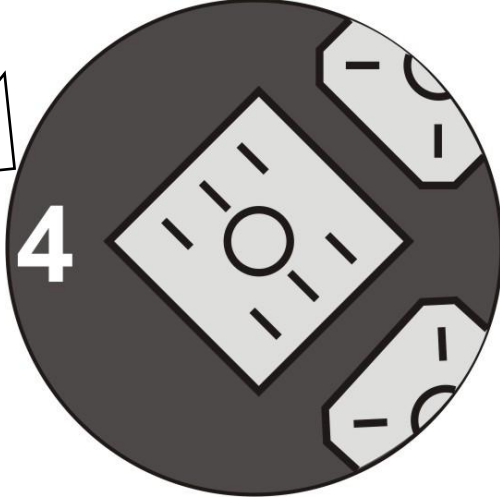
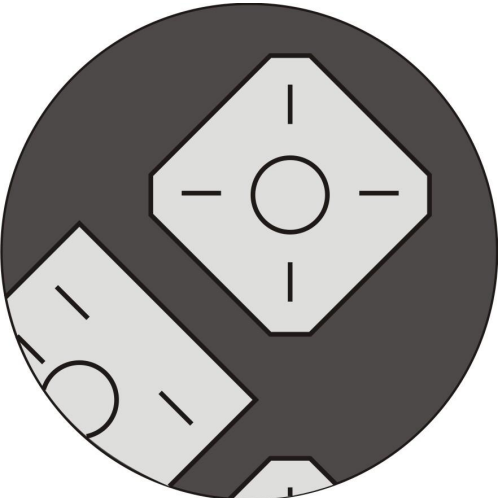
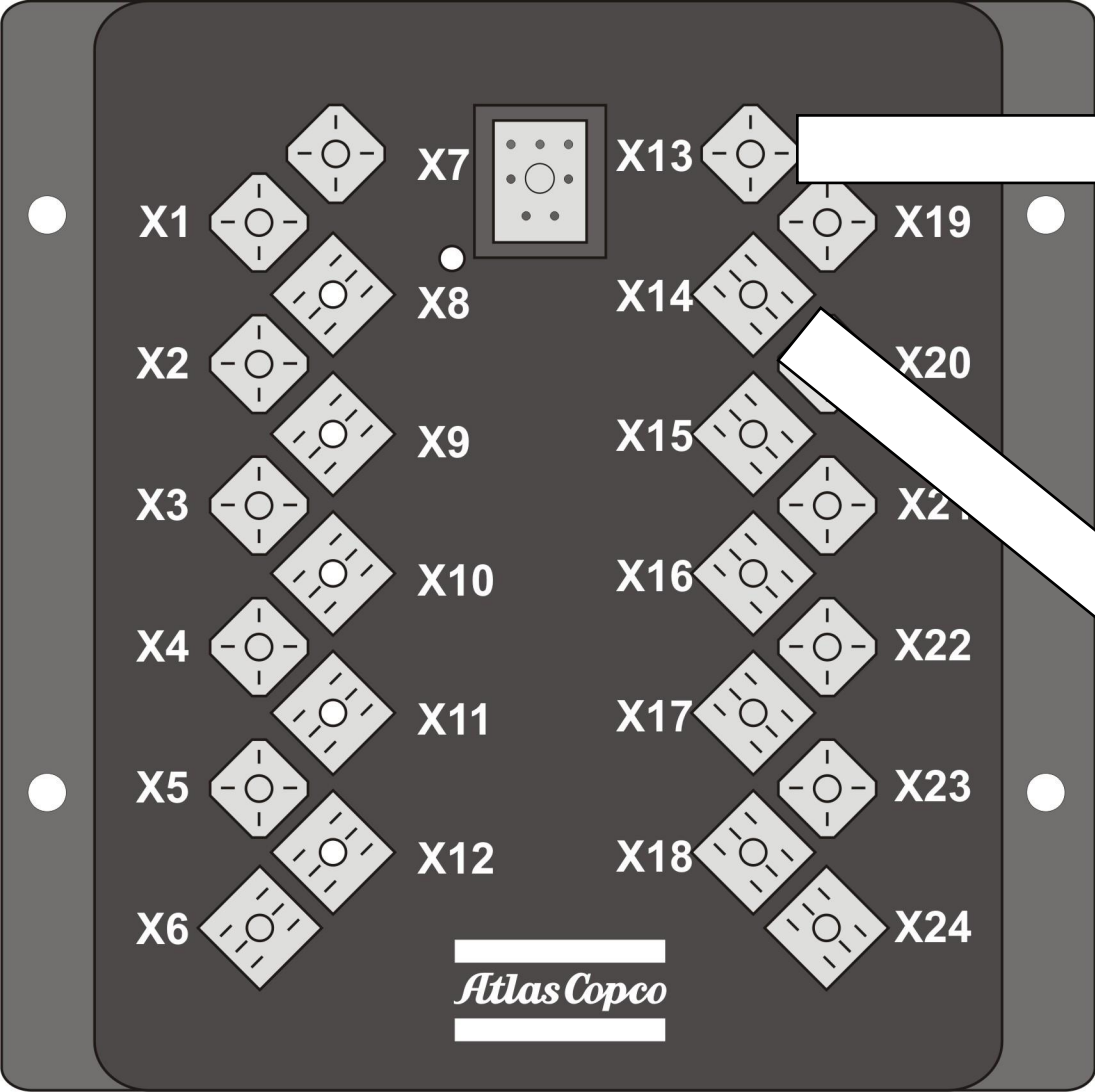

I/O Module

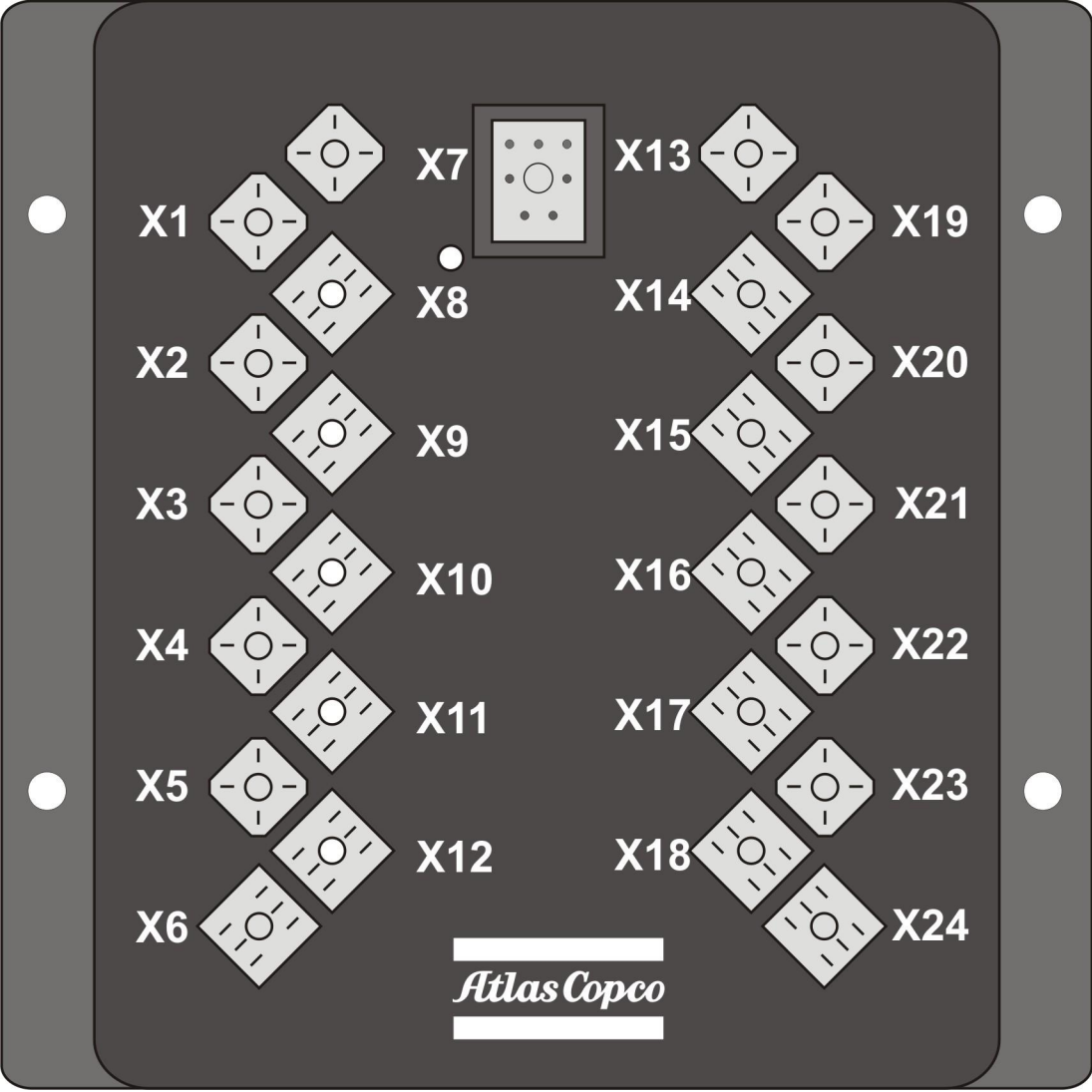

X24
Digital in

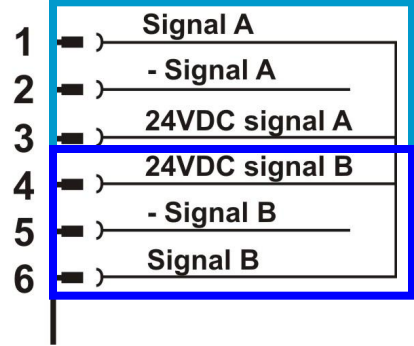

I/O Module

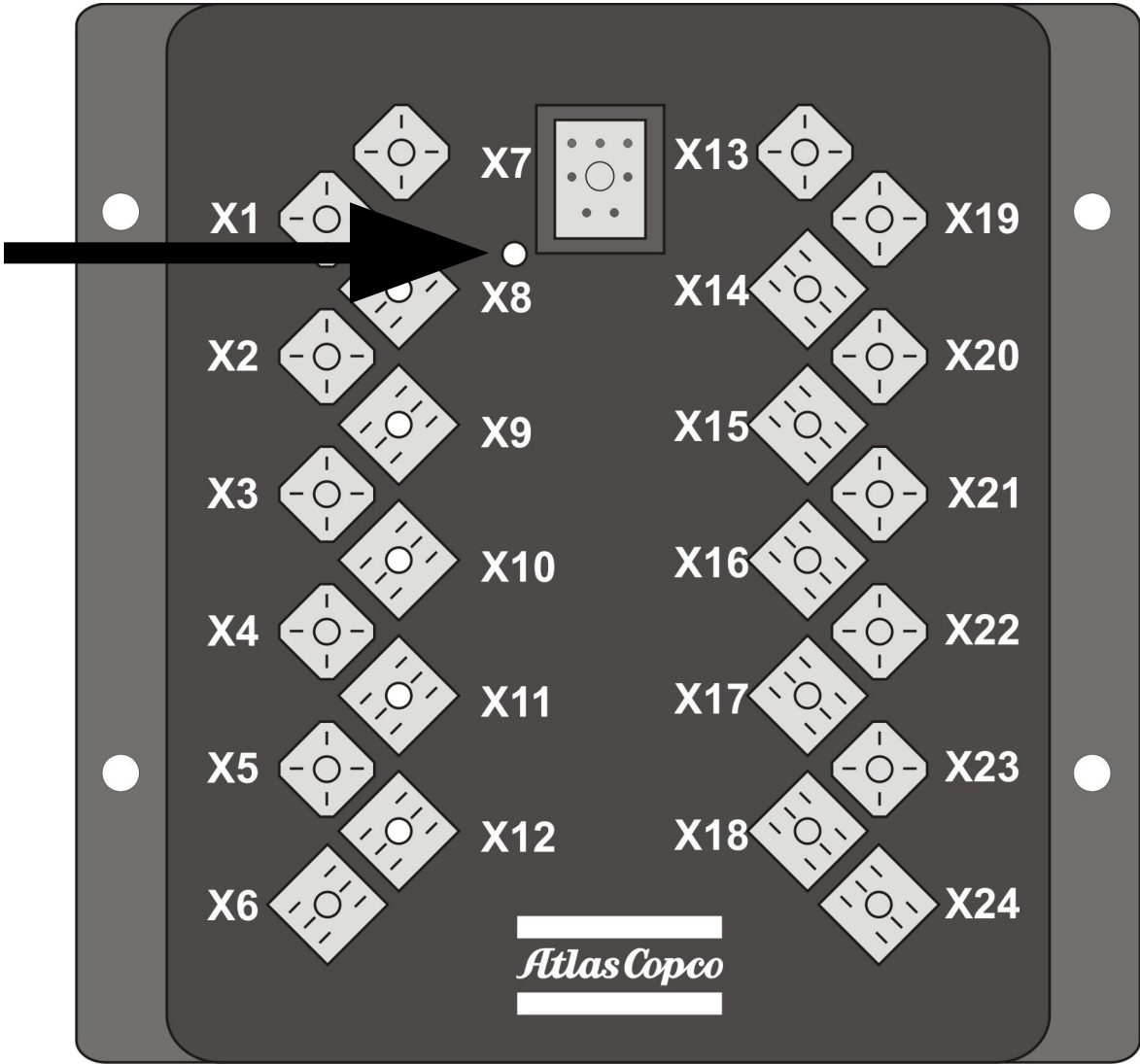

Resolver module



Exercise

Modules

Connect and address the system

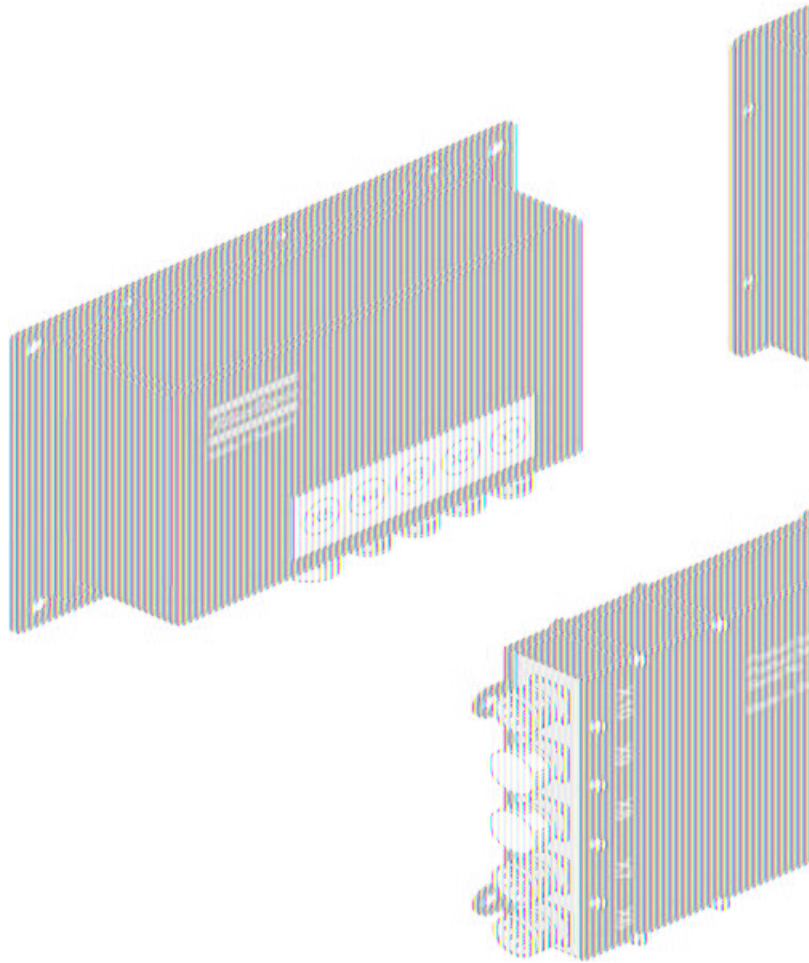

Boomer

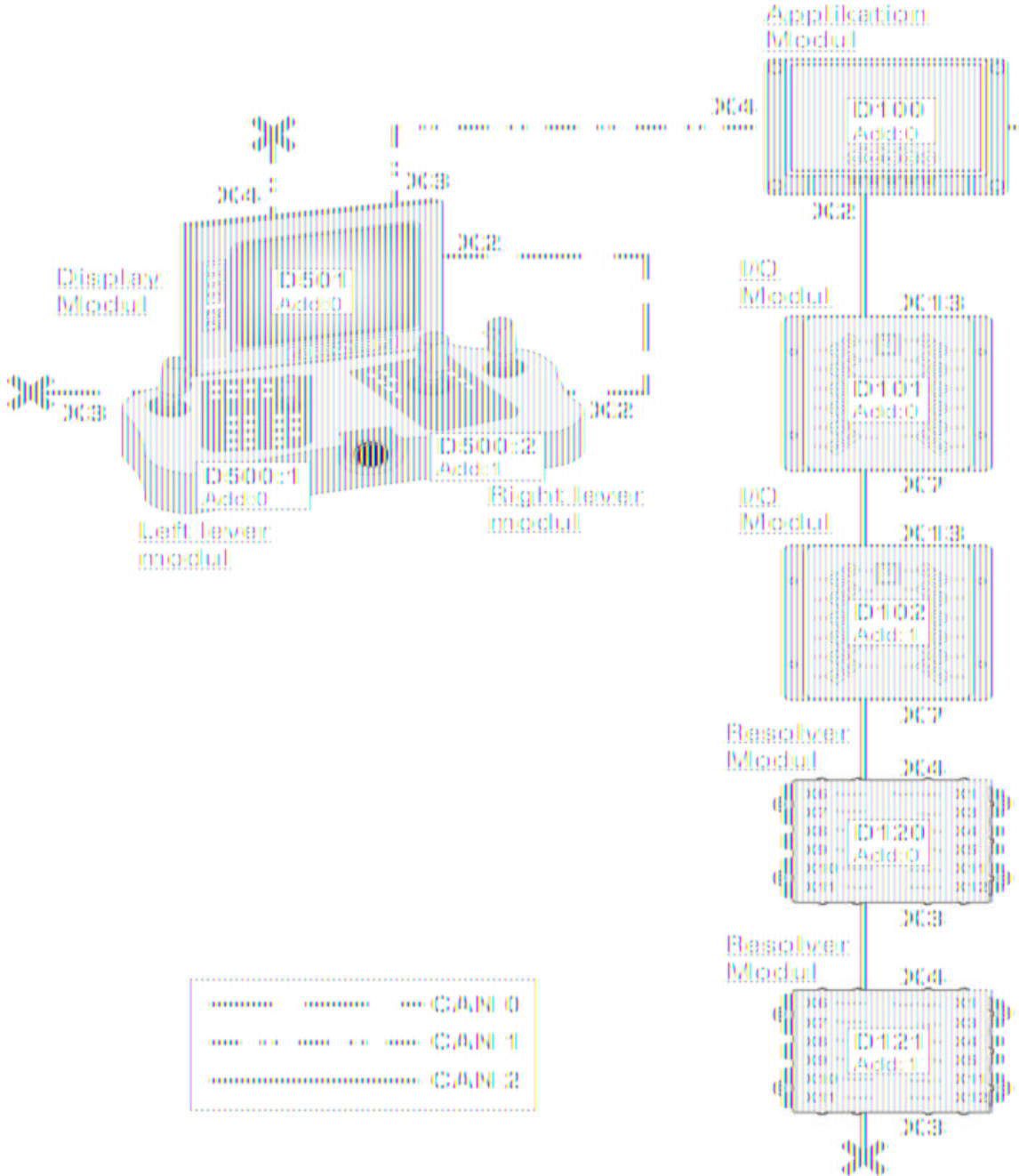

D7C

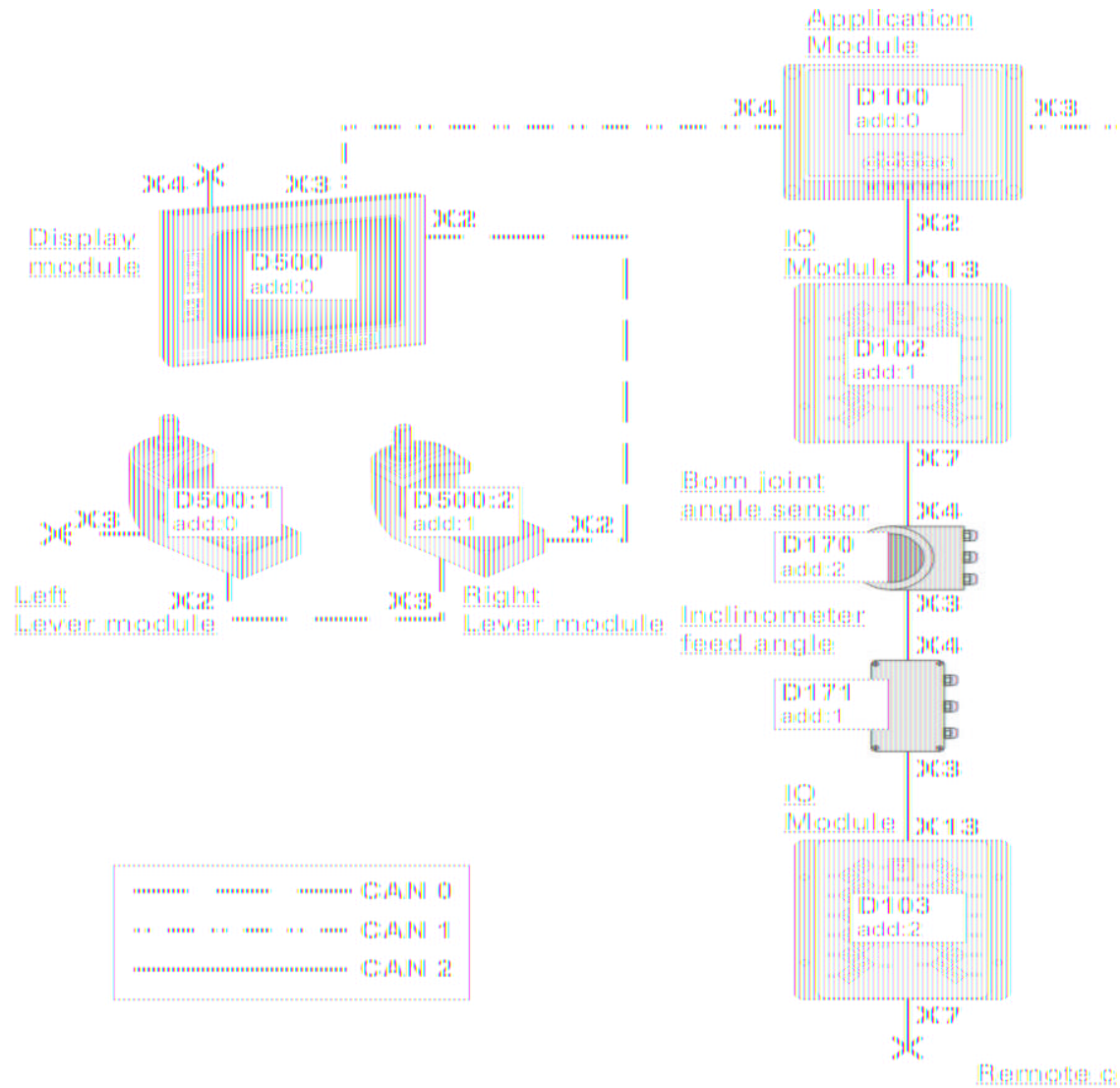

Simba

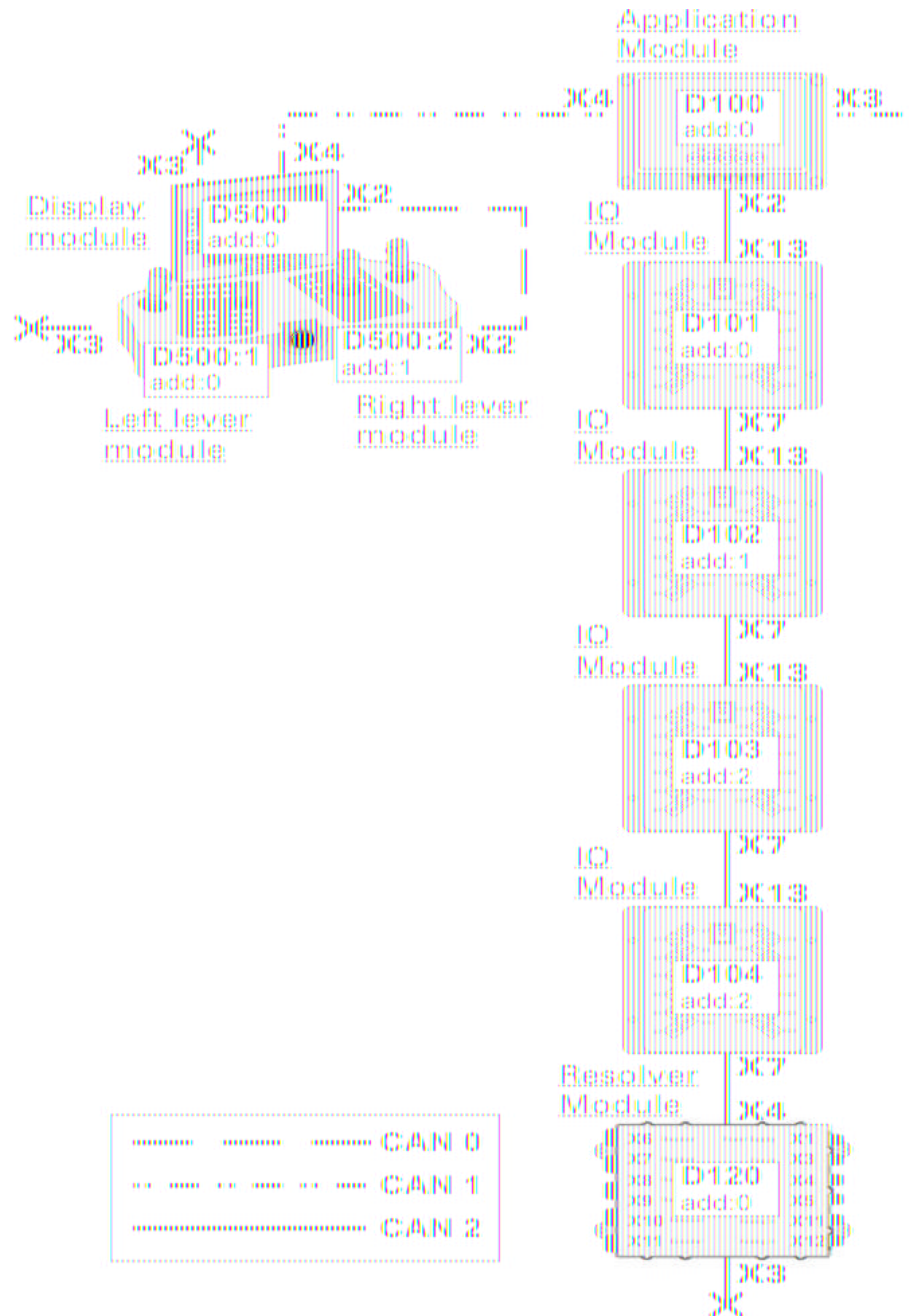

Boltec

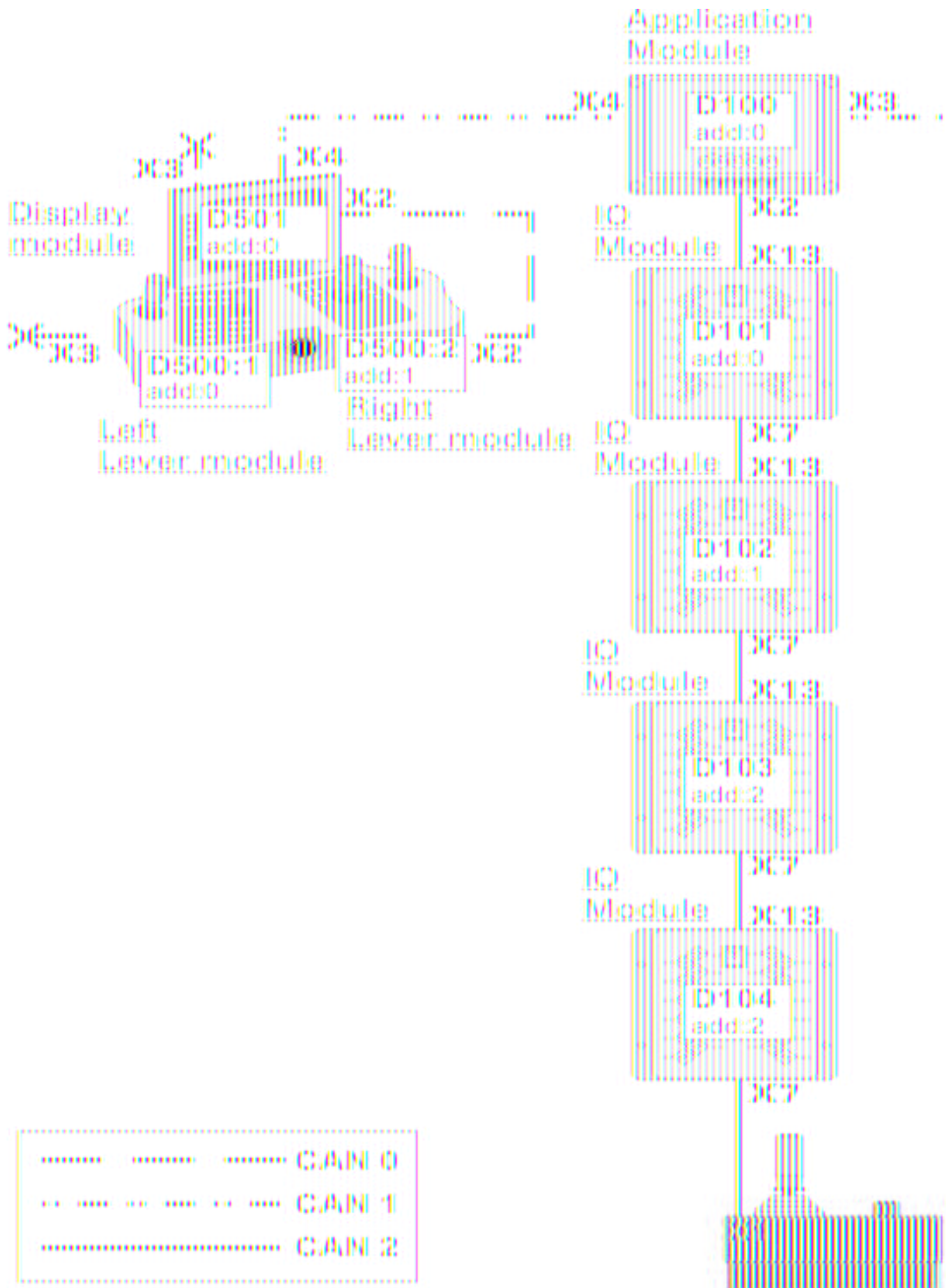

**We are committed to your
superior productivity through
interaction and innovation.**



Atlas Copco

