

Невозможные фигуры



Проект Воропаевой Анастасии

Первый невозможный треугольник Рейтерсварда

Иллюзия Рейтерсварда

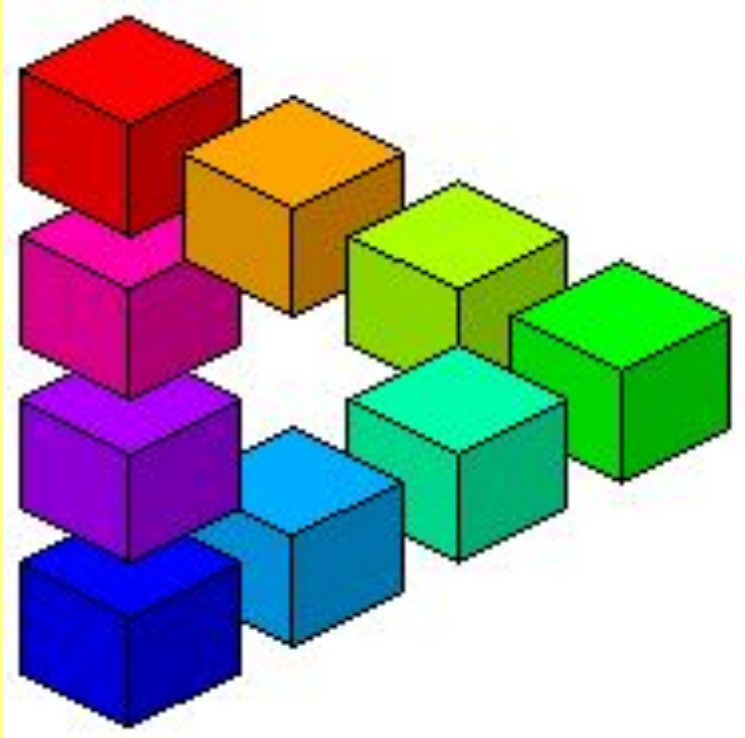

Изменение
организации
«фигура - фон»
сделало
возможным
восприятие
расположенной
в центре
«звезды»

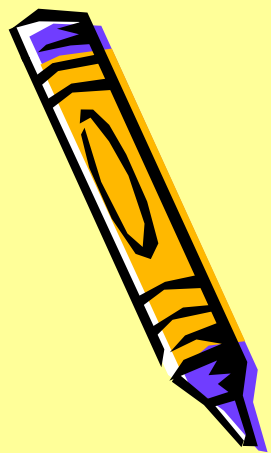

Марка
Первый невозможный
треугольник Рейтерсварда

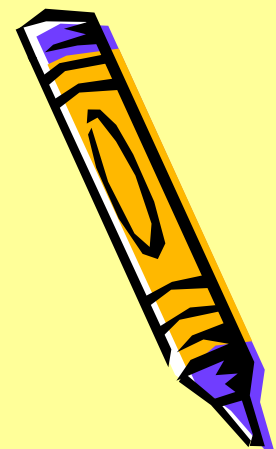

Треугольник Пенроуза

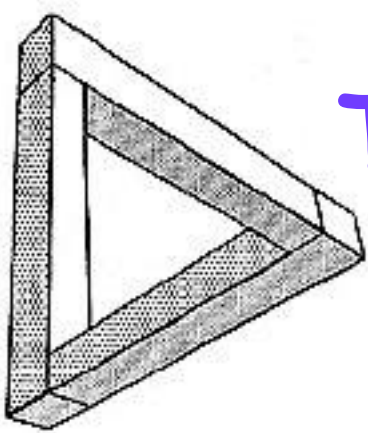

Водопад Эшера

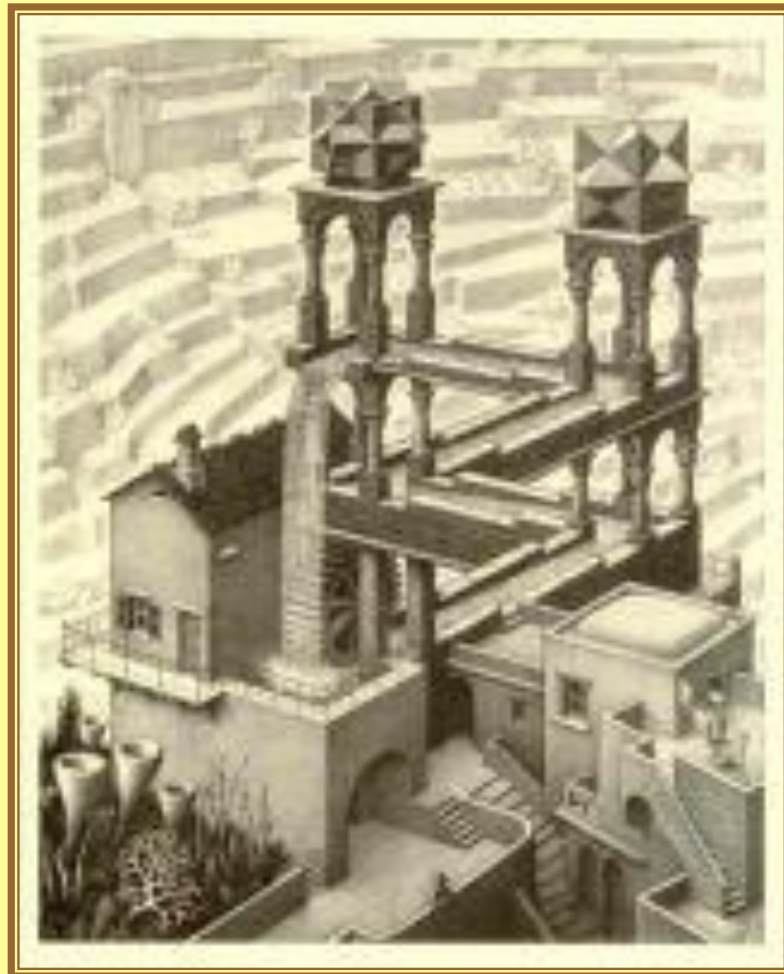

Фигуры невозможного треугольника Маттье Хемакерза.

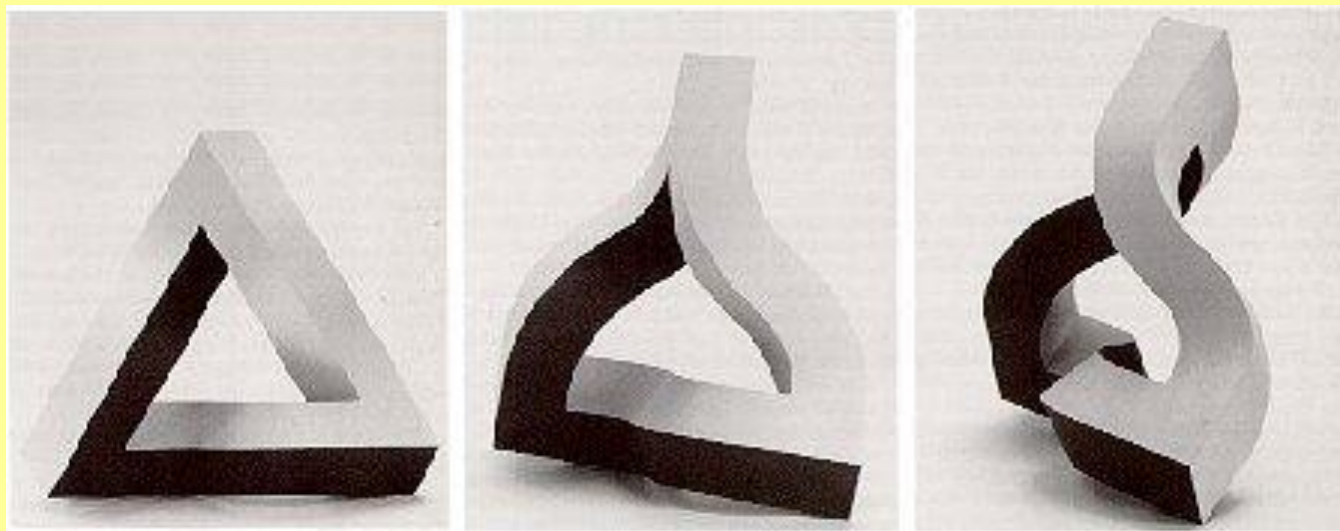

Невозможные треугольники Элбера Гершона.

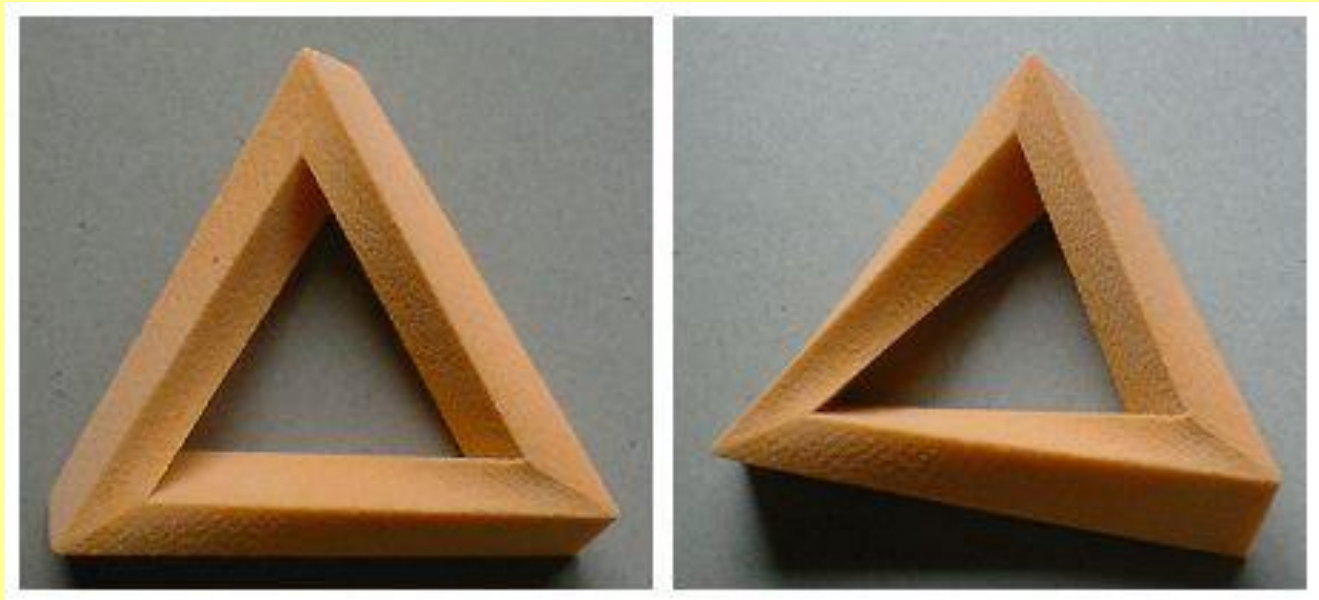

Невозможный трезубец

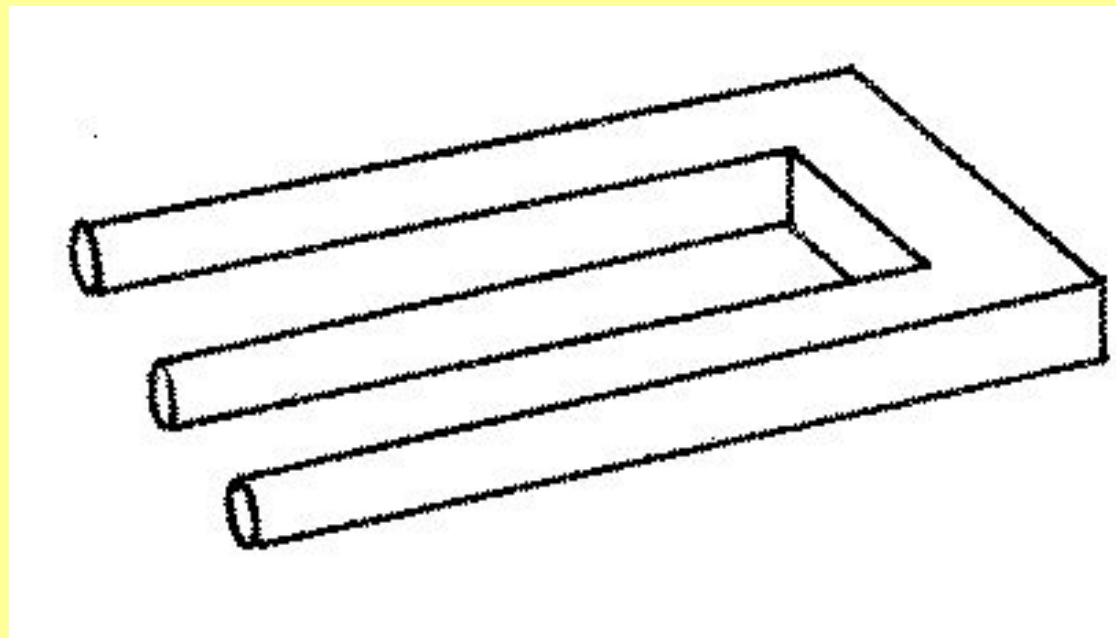

Сколько здесь колонн?

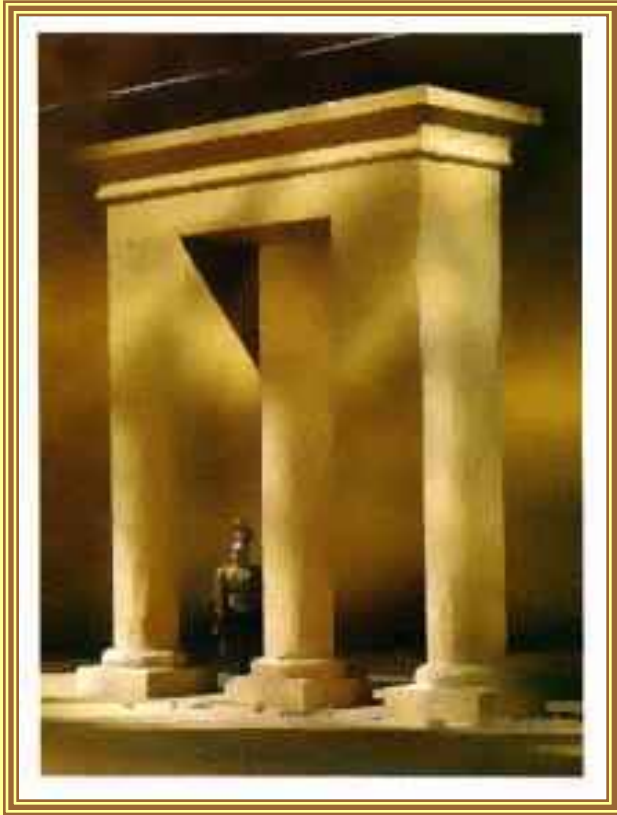

Конструкция подобная
невозможному трезубцу.



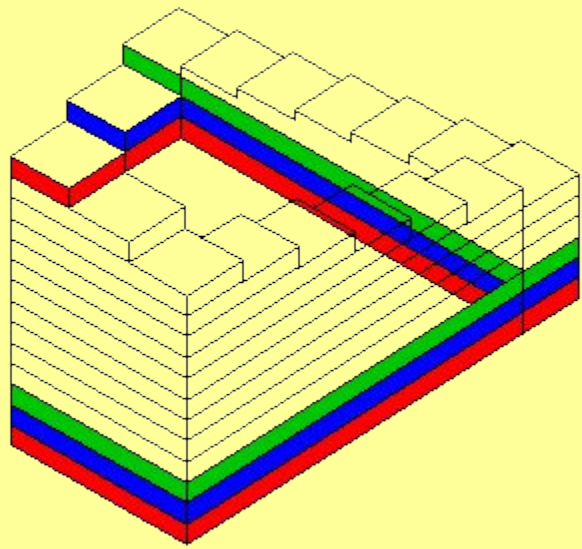

Бесконечная лестница, ведущая вверх

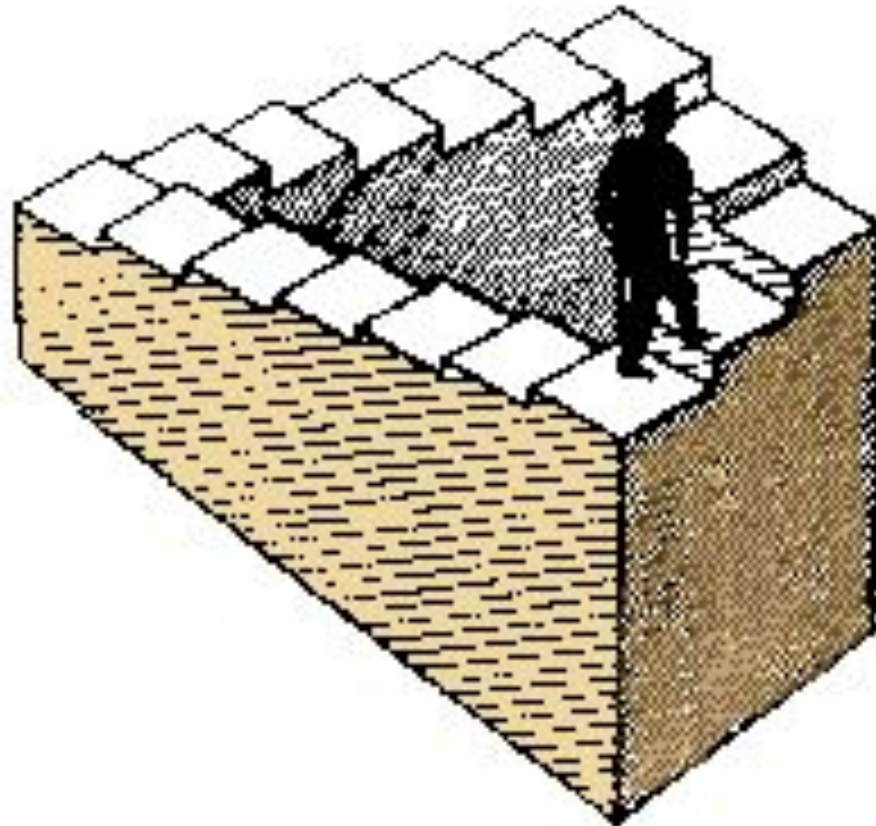

Невозможный коробок



Невозможное расположение карандашей

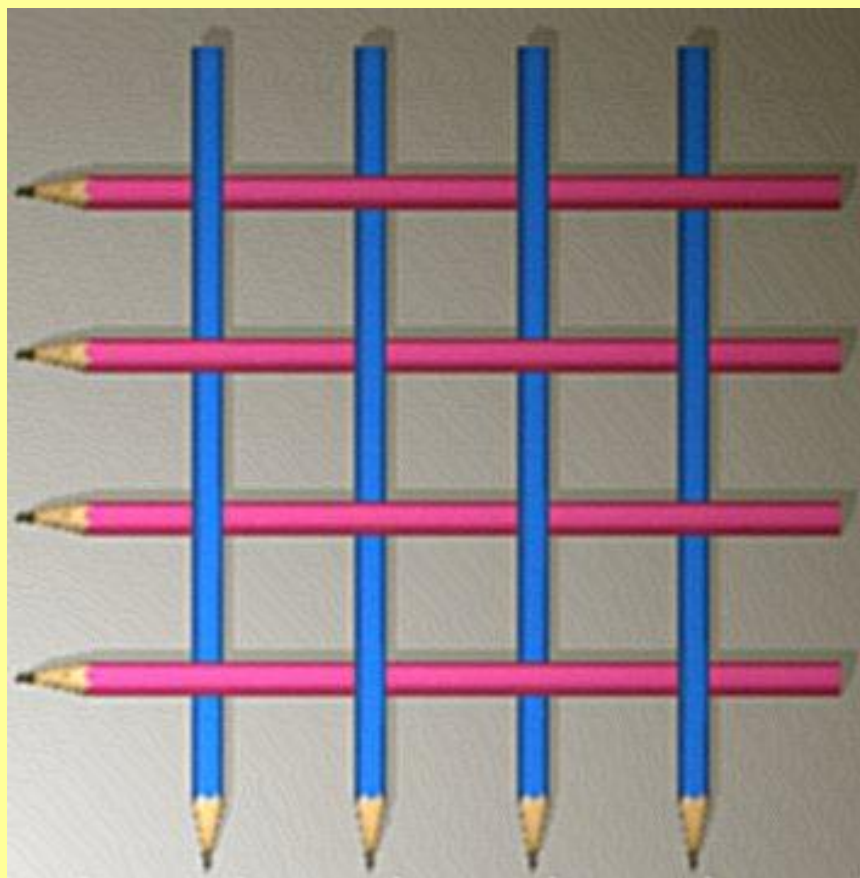

Невозможное расположение карандашей

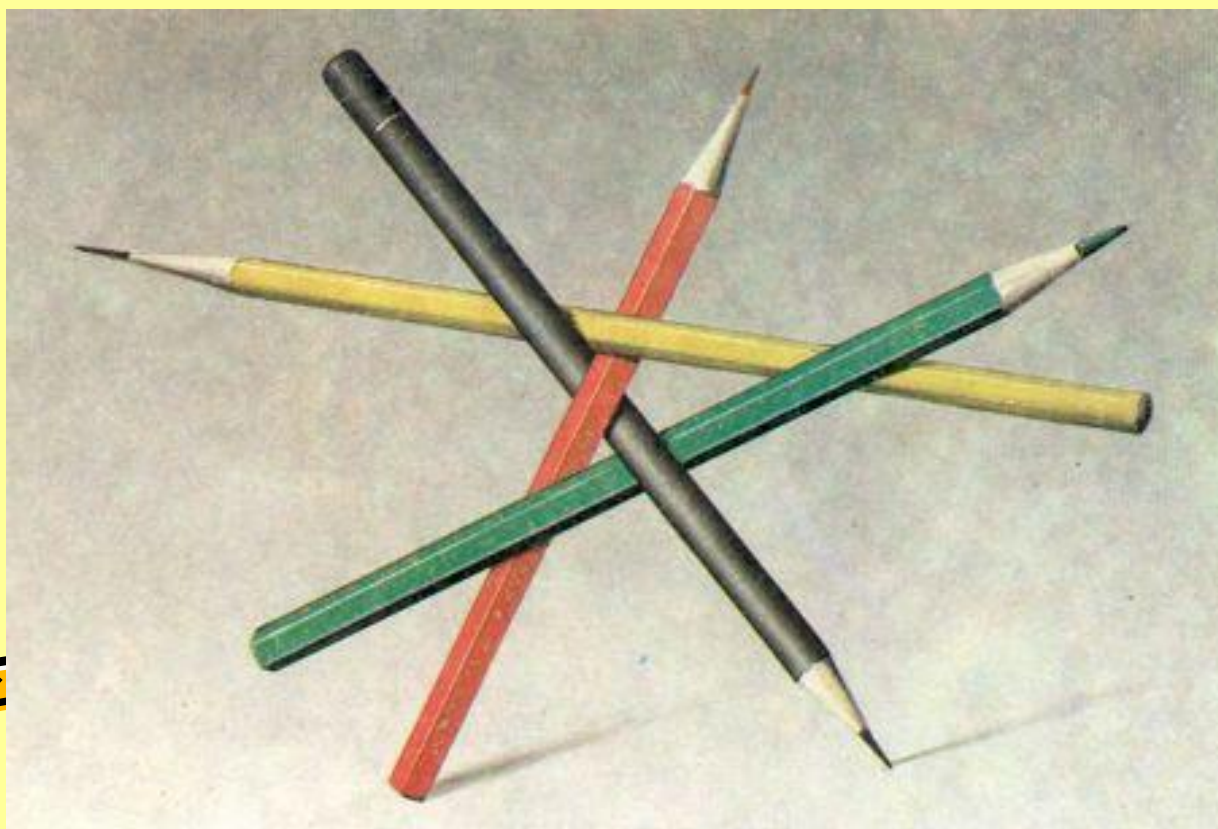

Невозможные фигуры

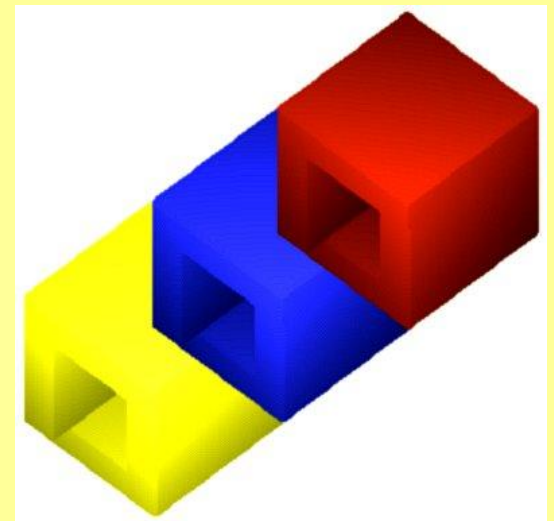
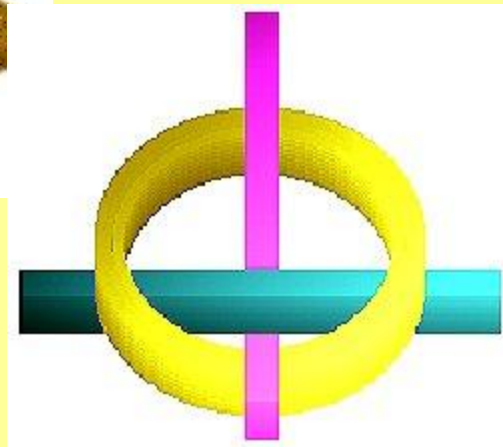
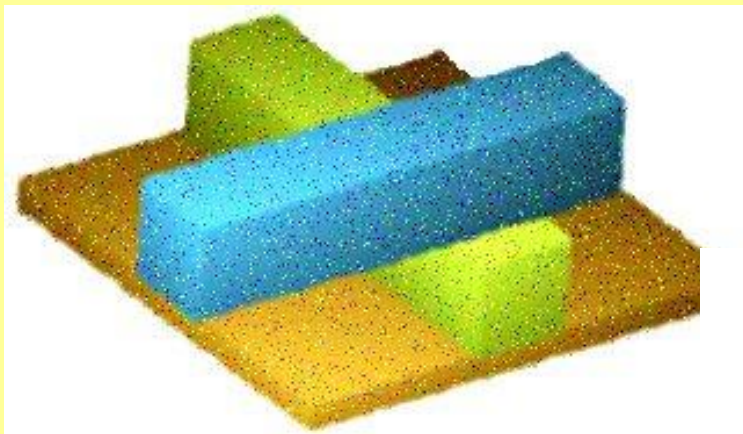
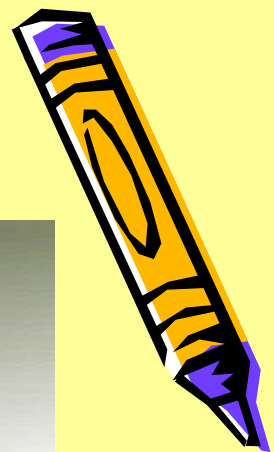
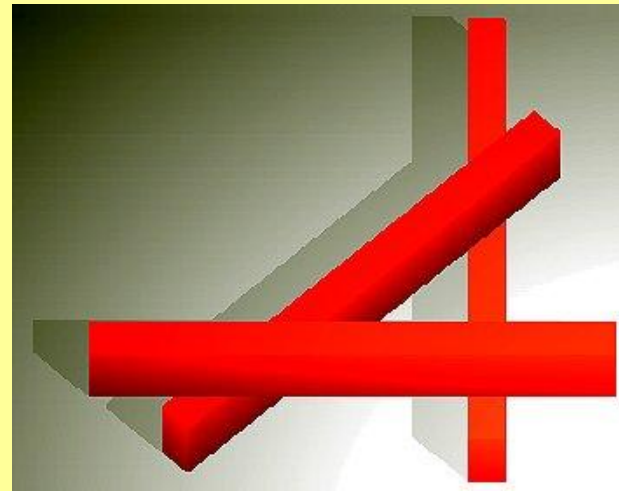
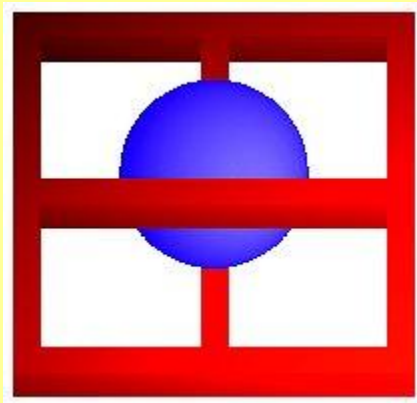

Объединённая невозможная фигура

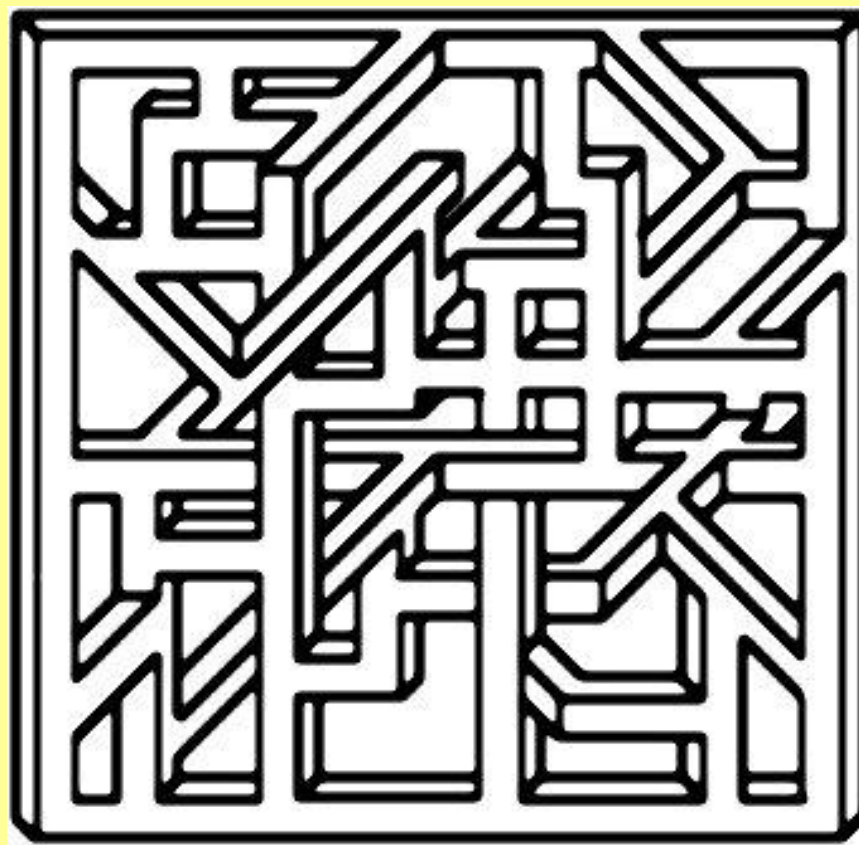

Сколько у слона ног?

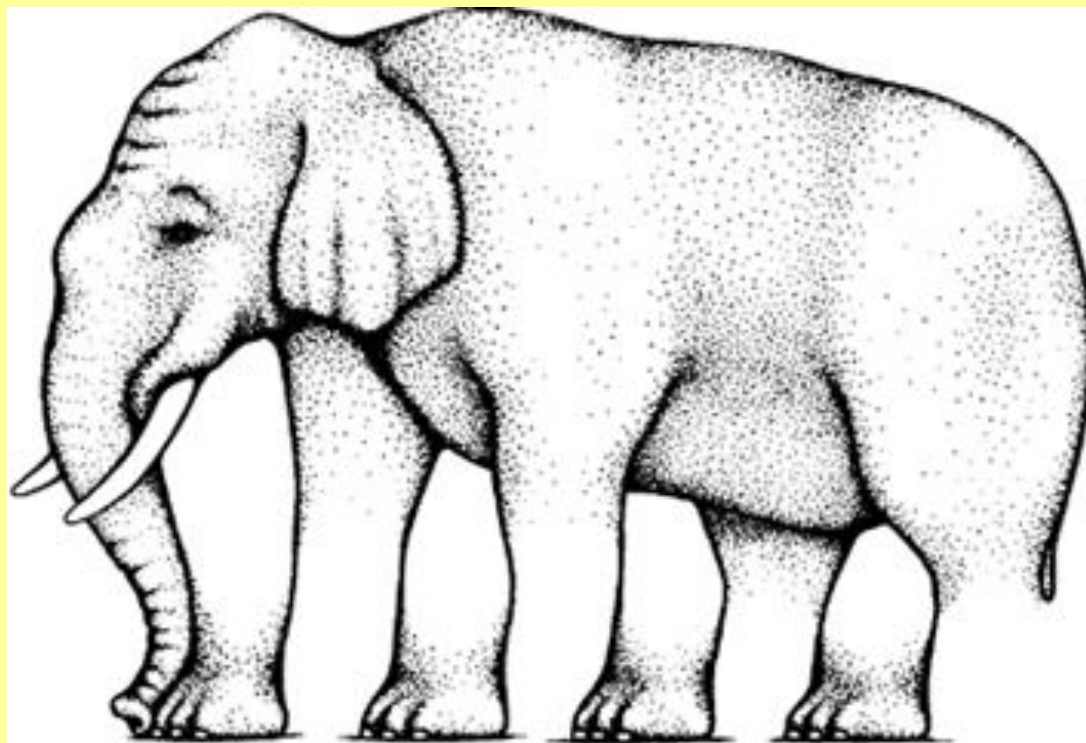

1
5

А сколько ног у
жирафа?

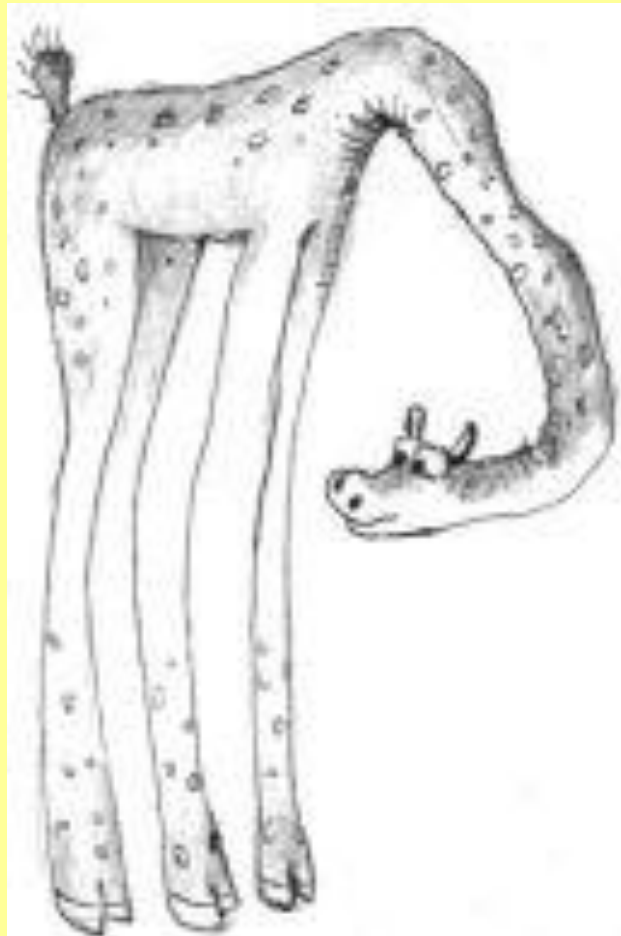

1
6



СКОЛЬКО ТУТ ДИНОЗАВРОВ?

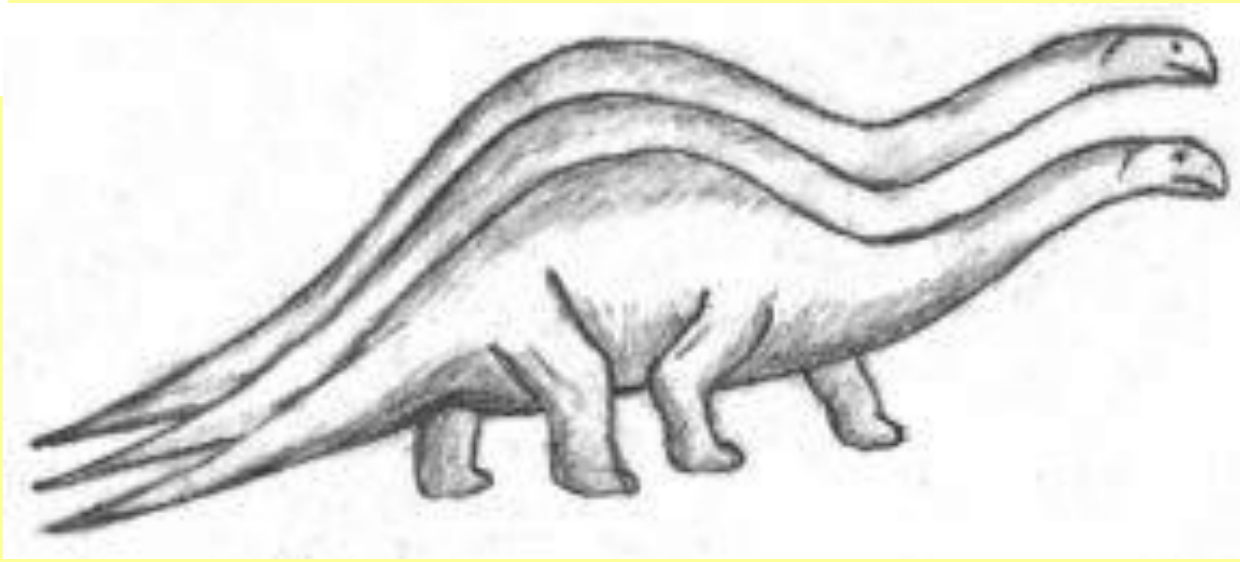

СКОЛЬКО НОГ?

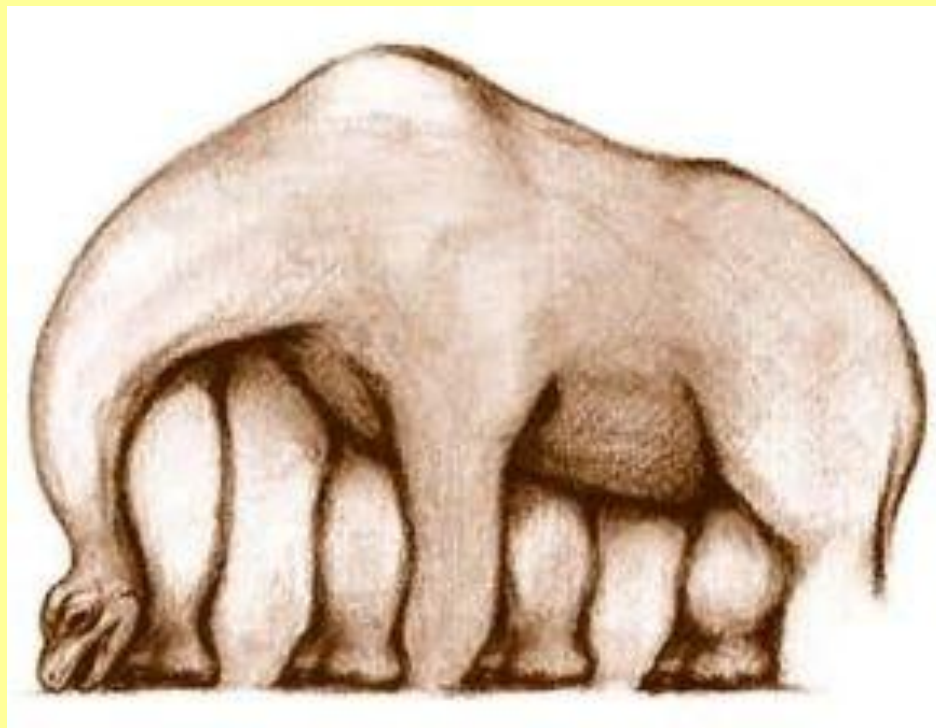

1
8

Сколько тут полок?



Три или четыре?



Что-то не так с
пальцами?

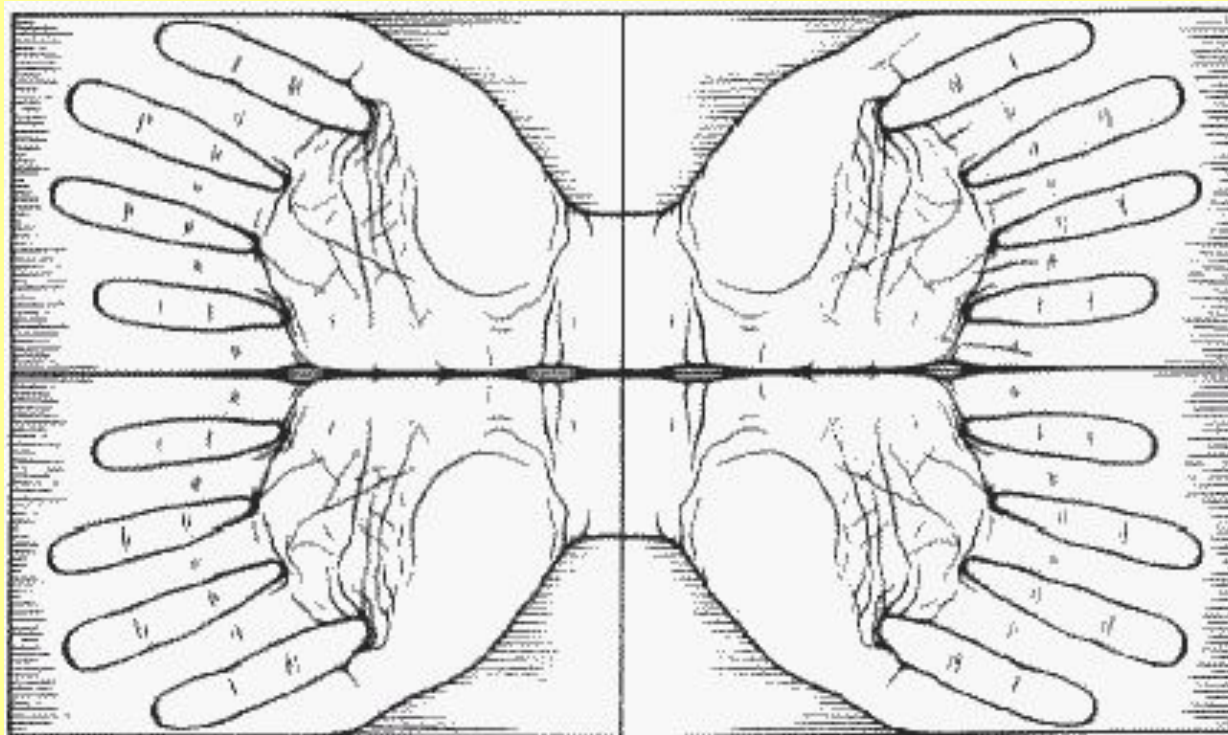

Иллюзия итальянского ресторана



Найдите 5 ошибок



Сколько тут элементов?

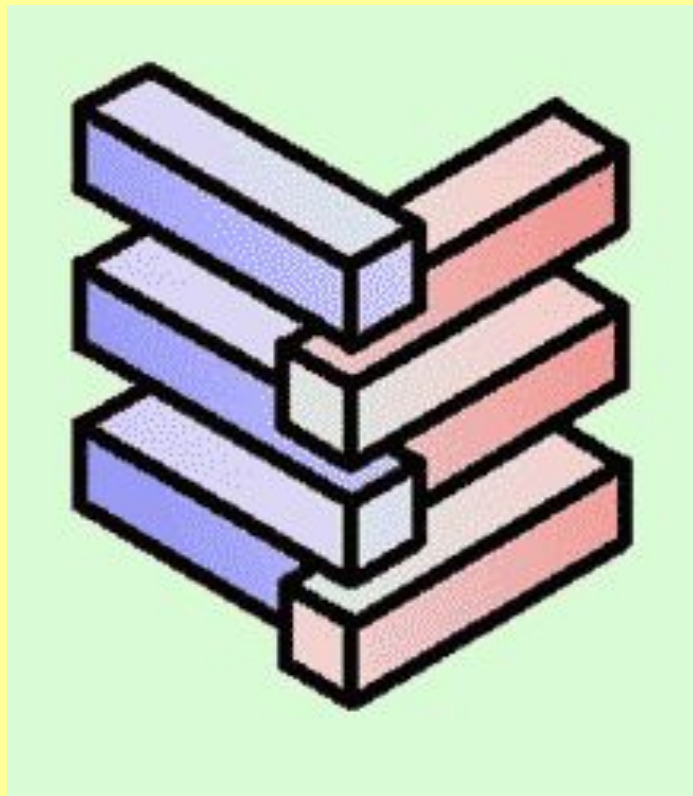

Шесть или четыре?



Удивительные сиденья

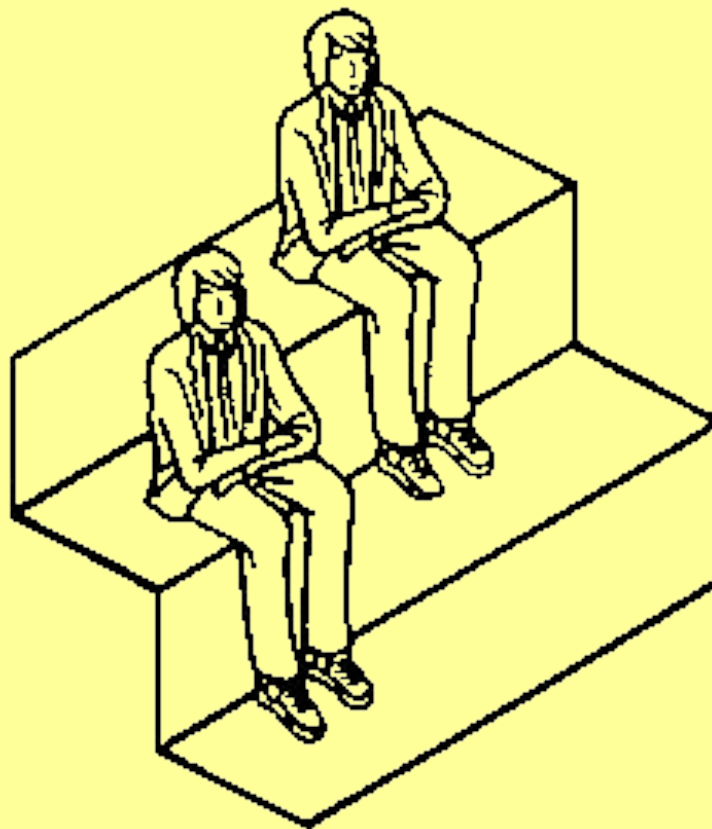

Невозможный куб Эшера

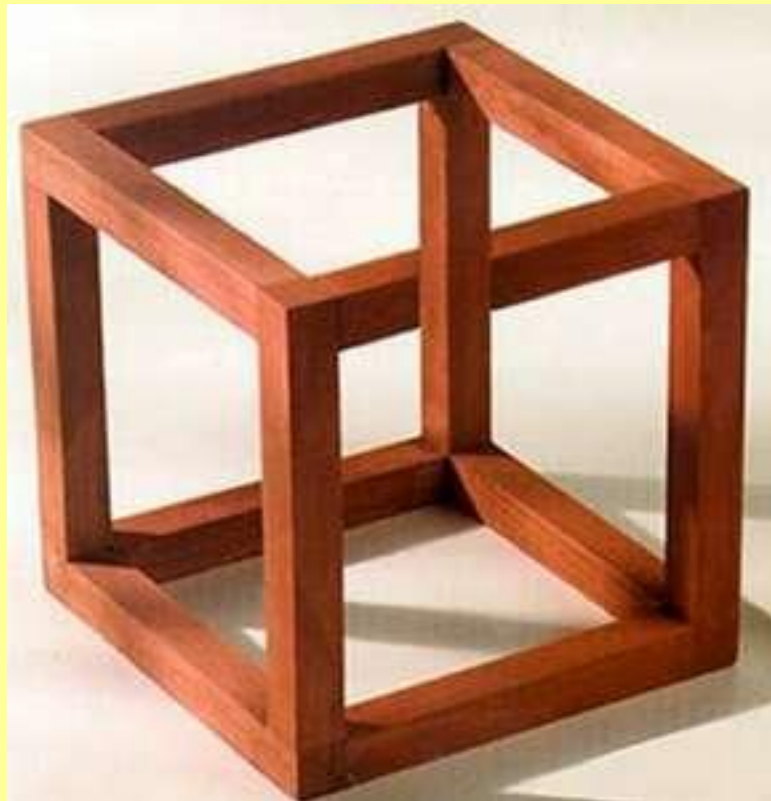

Ещё один невозможный куб

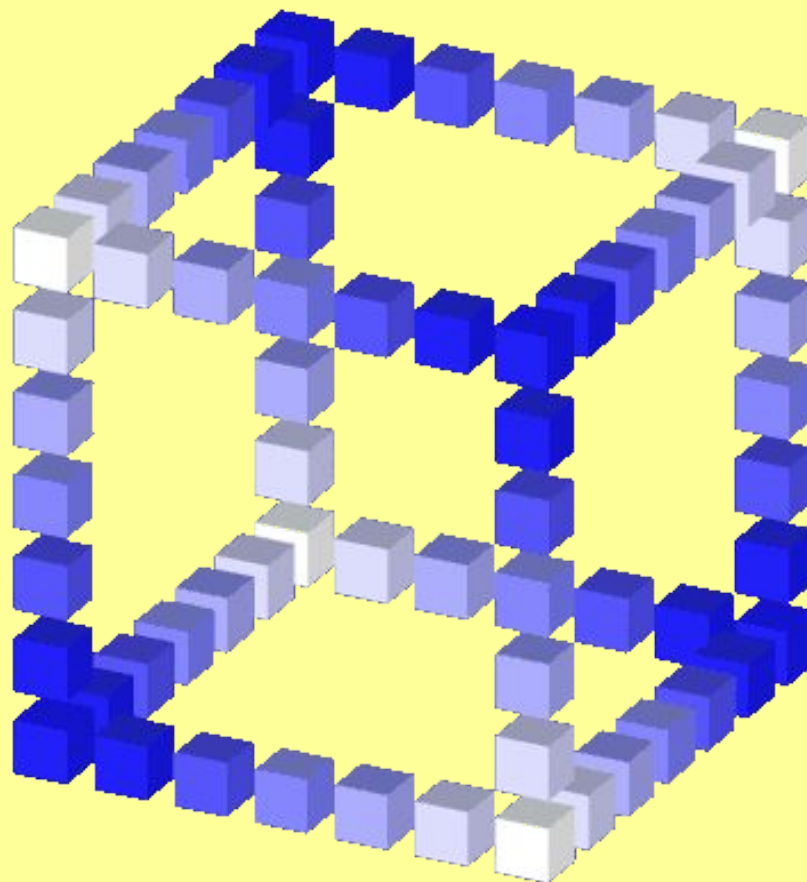

Невозможное колесо

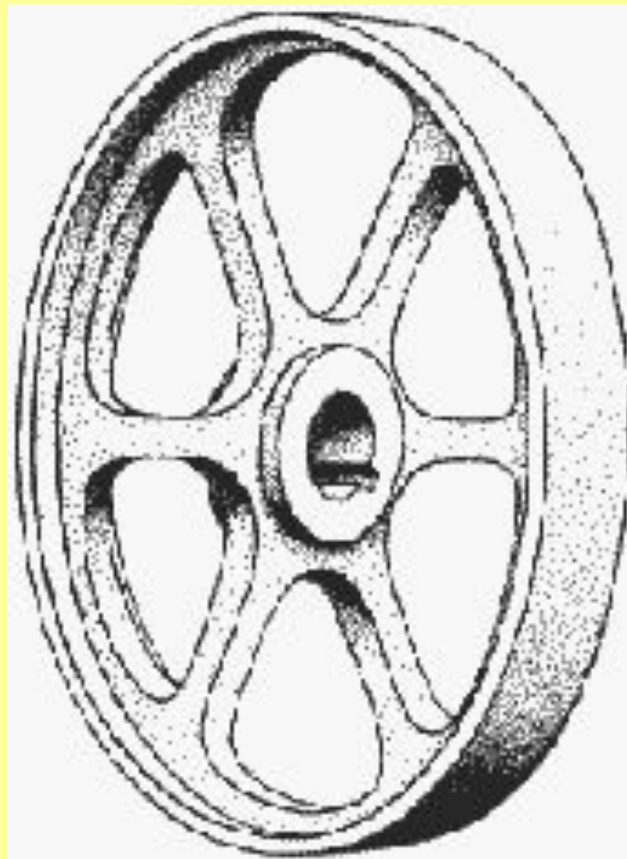

Удивительный узел

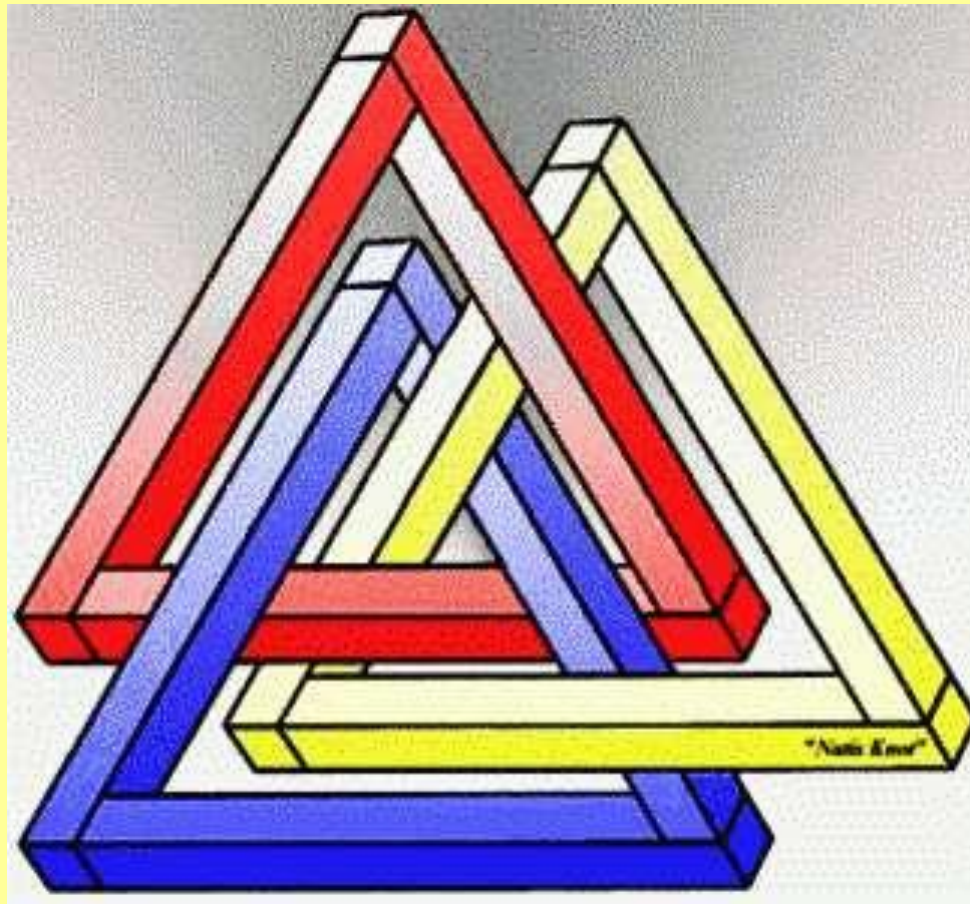

Куда открыта дверь?

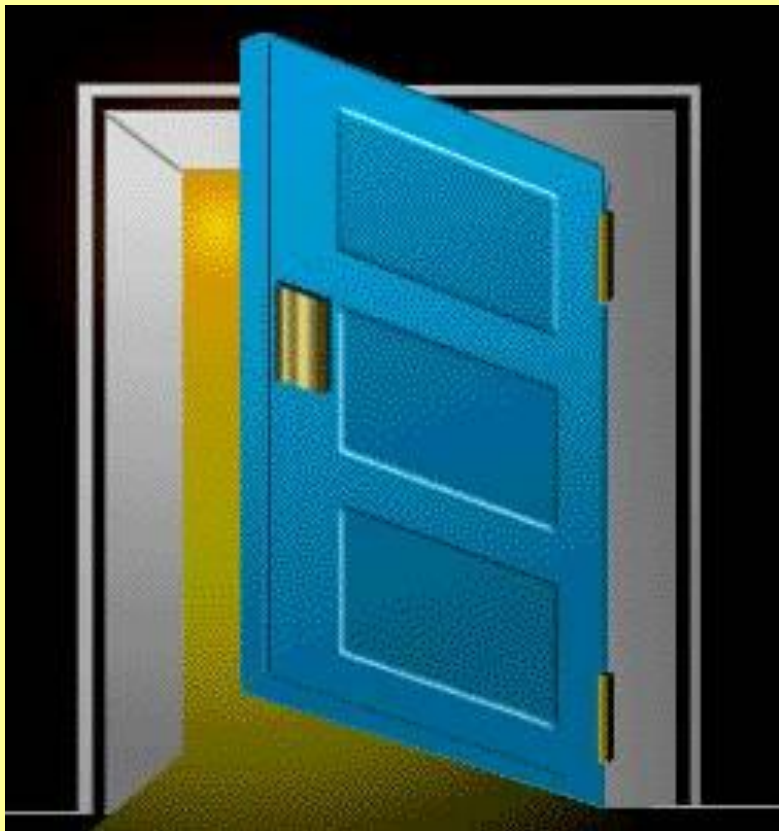

Наружу или
вовнутрь?



Невозможное окно



Невозможная ГОЛОВОЛОМКА

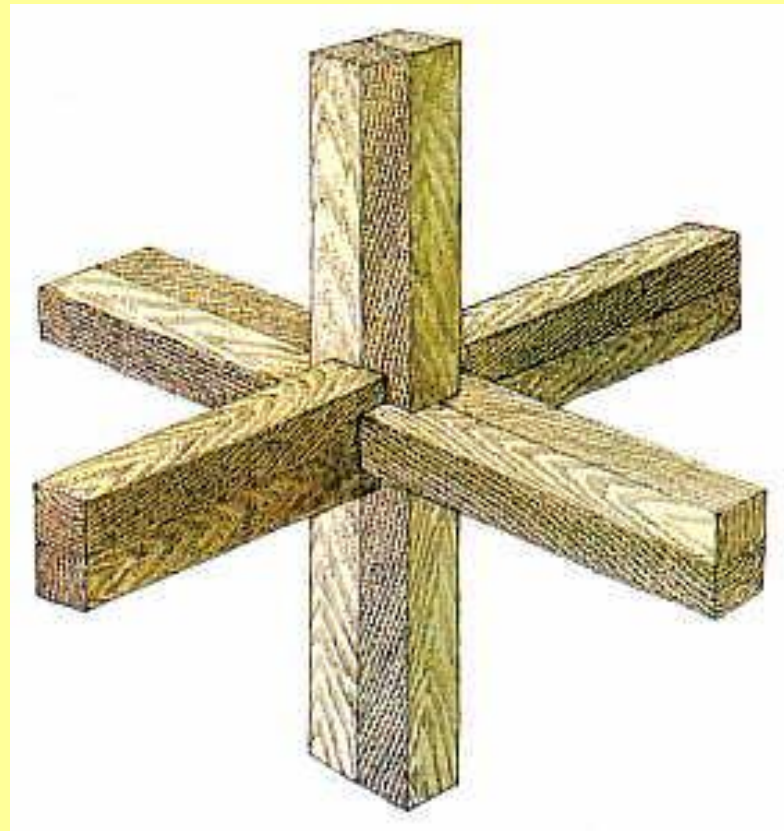

Невозможное сечение куба



Фантастическая витрина

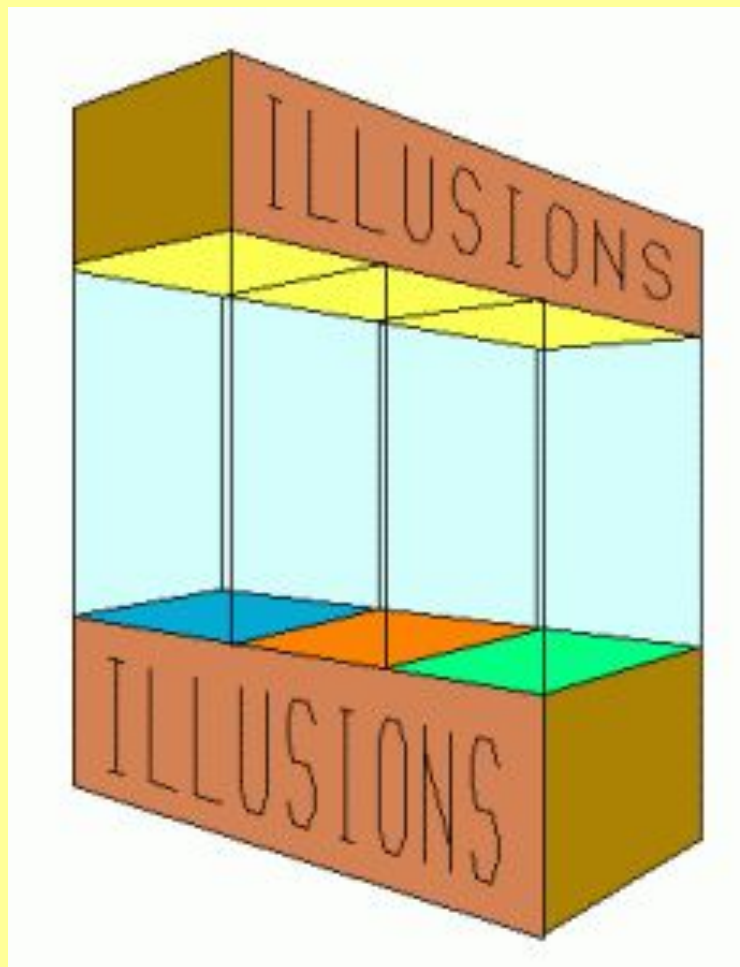

Невозможный пацифик

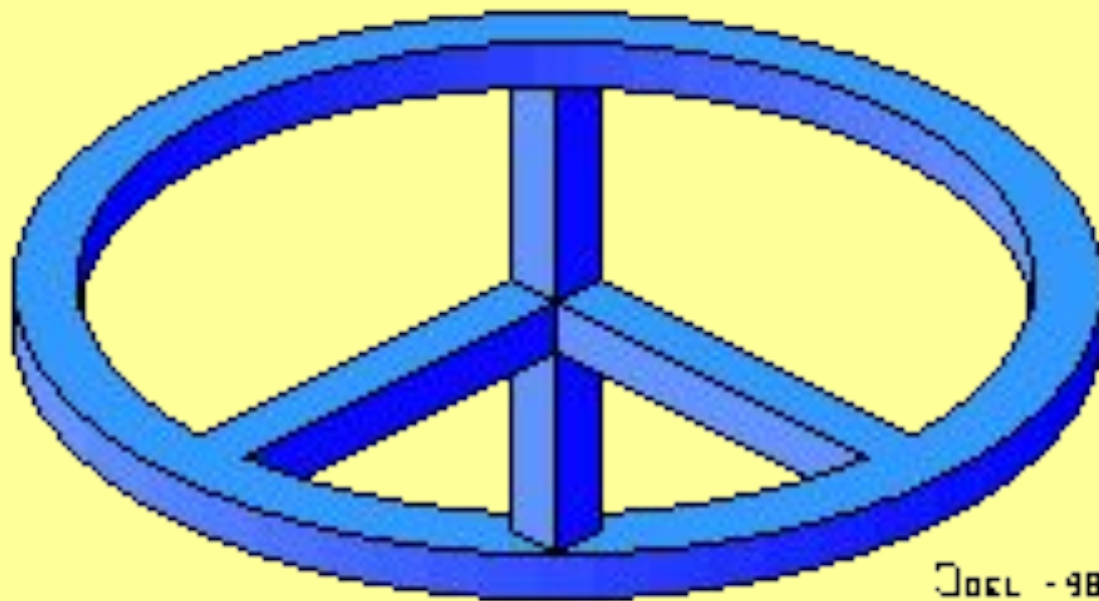

Эосл - 98



Бесконечная фотография

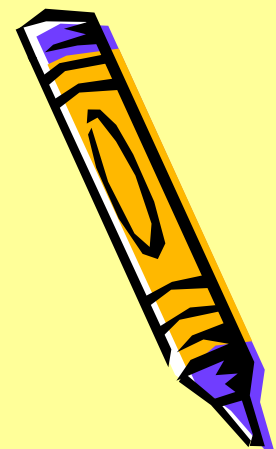

Бесконечная фотография

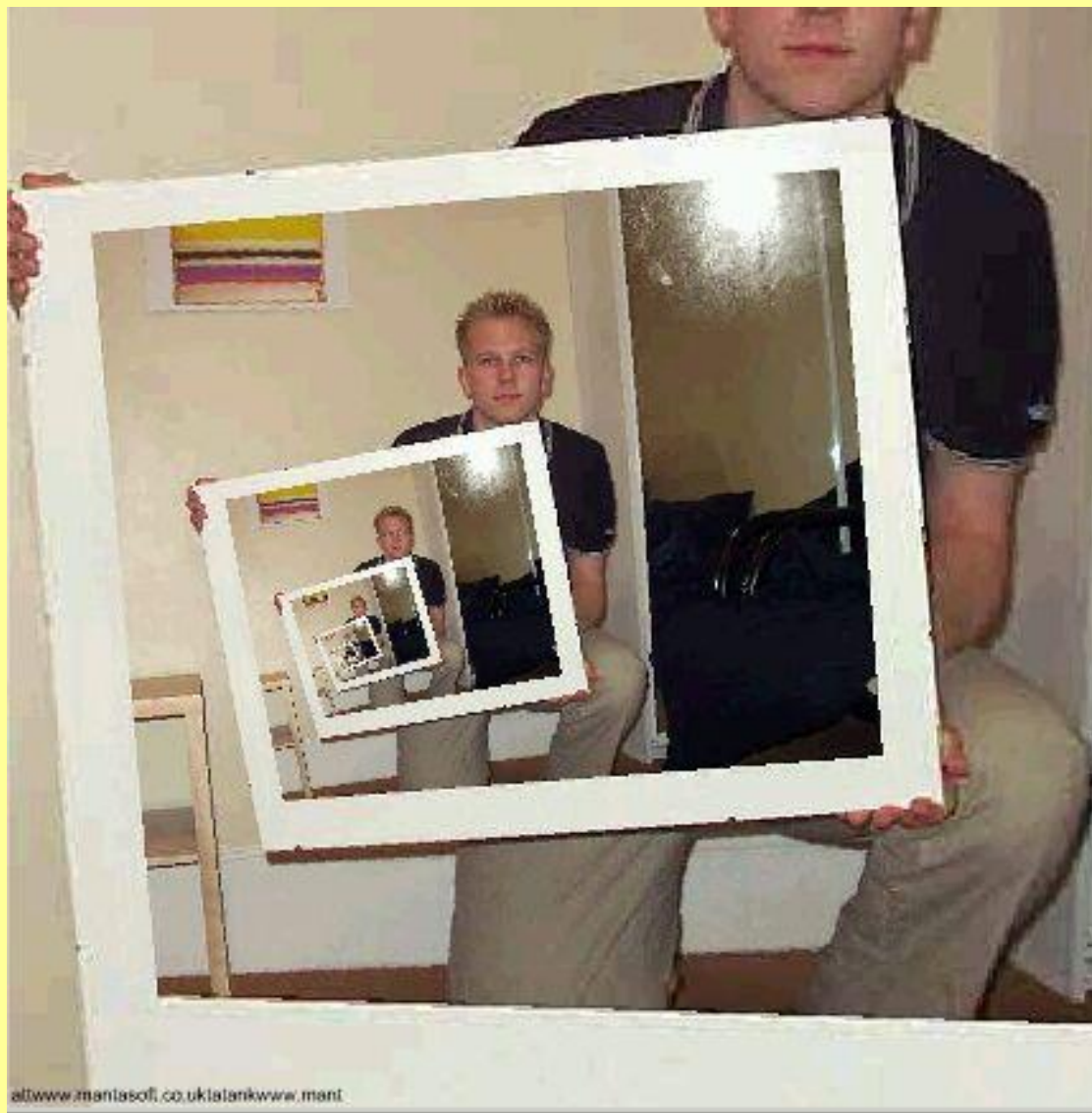

Странное зеркало



Дмитрий Раков. Город

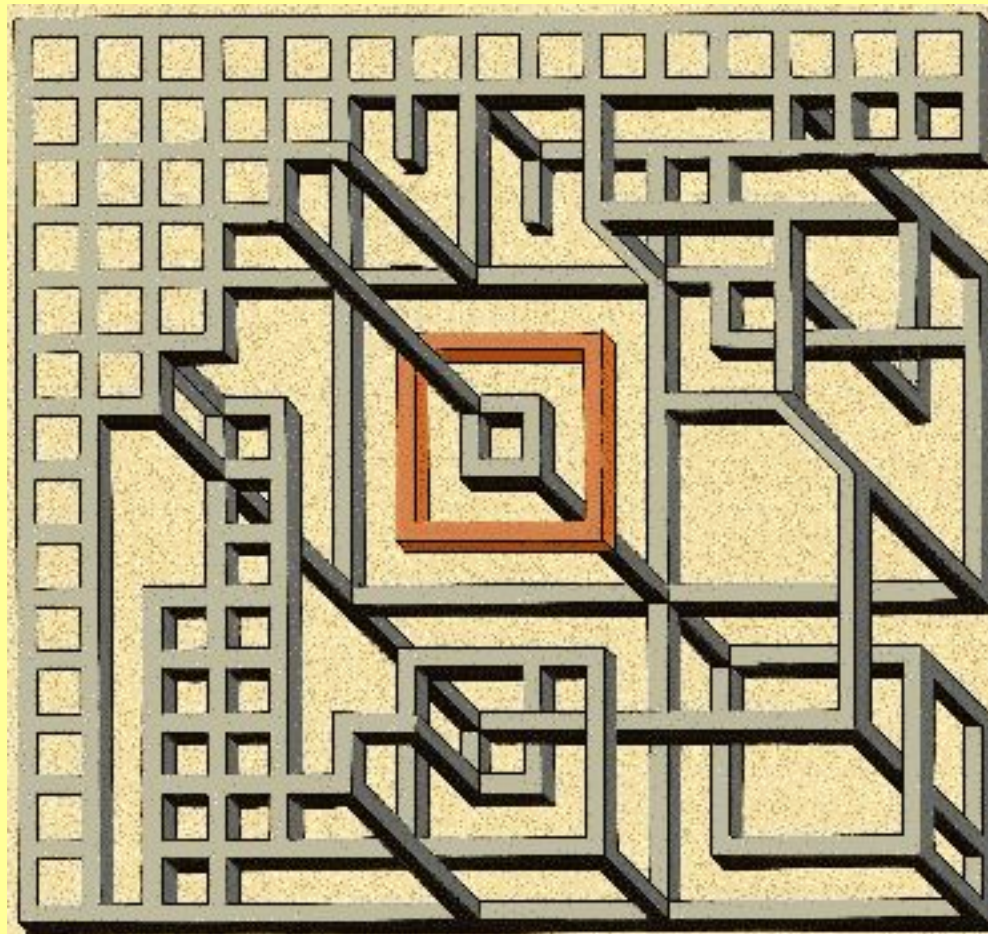

Подшипник Мёбиуса



Картина

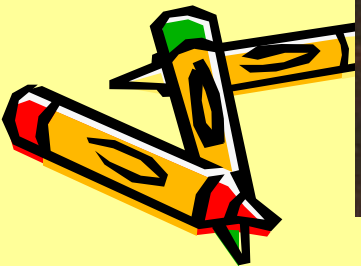
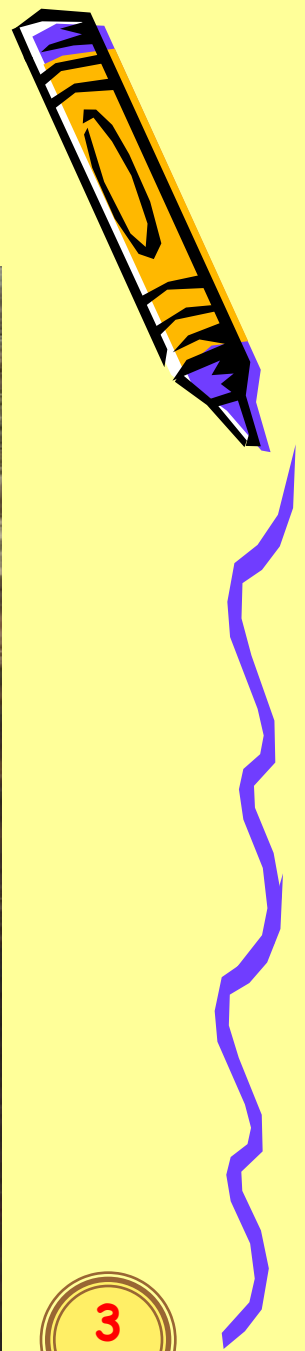

Картина



Мальчик из кошмаров

