

Рис.1



Рис.2



Рис.3

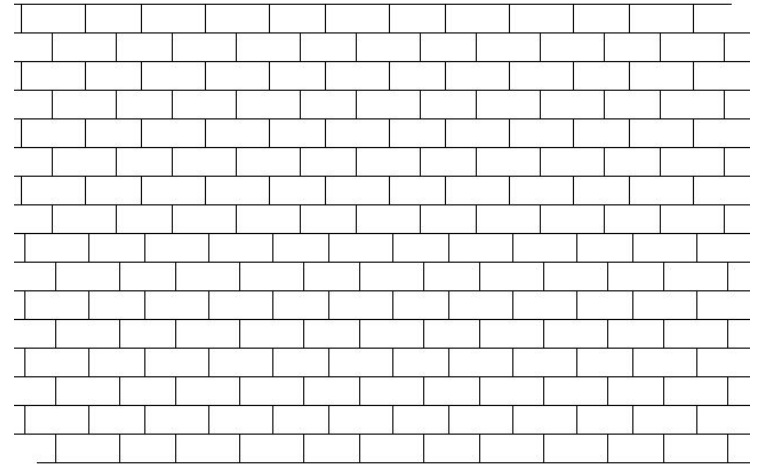

Рис.4



Рис.5

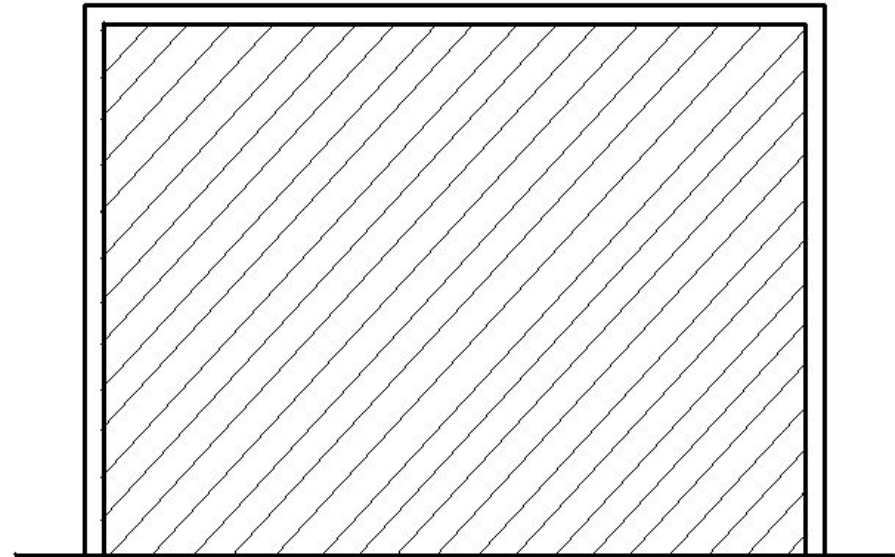

Рис.6

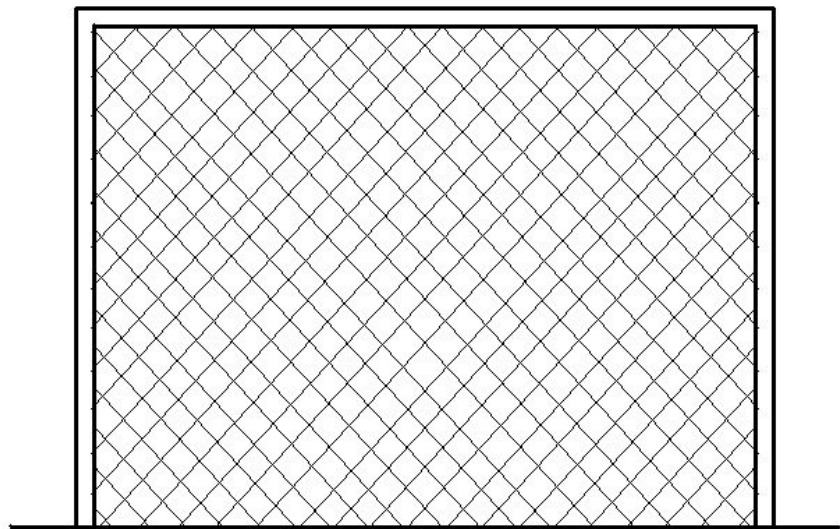

Рис.7

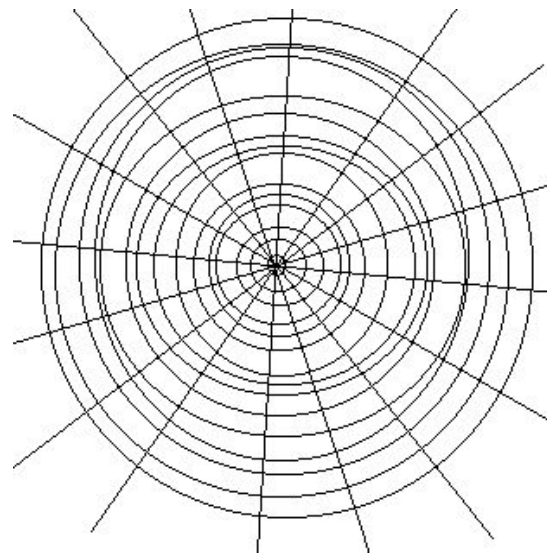

Рис.8

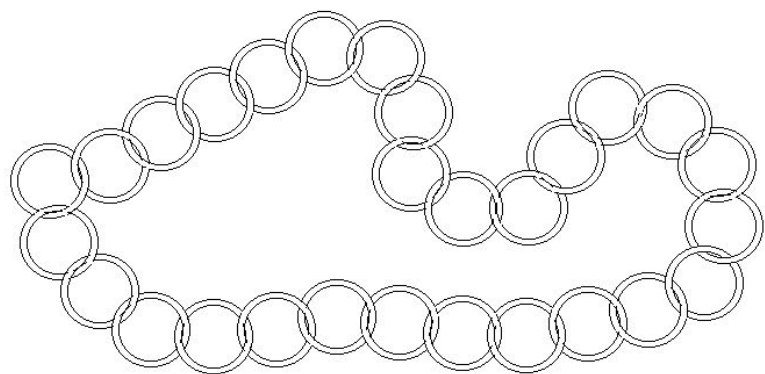

Рис.9

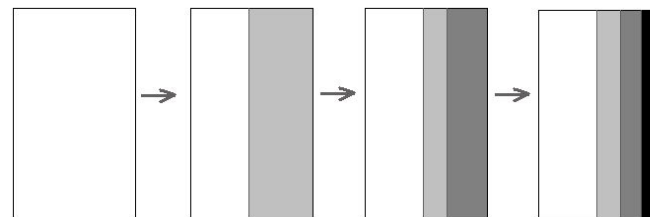

Рис.10

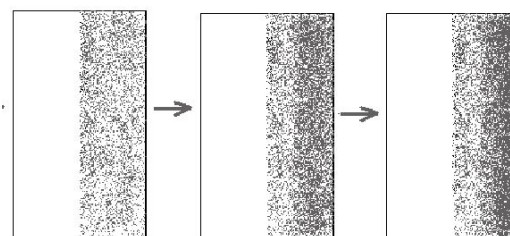

Рис.11

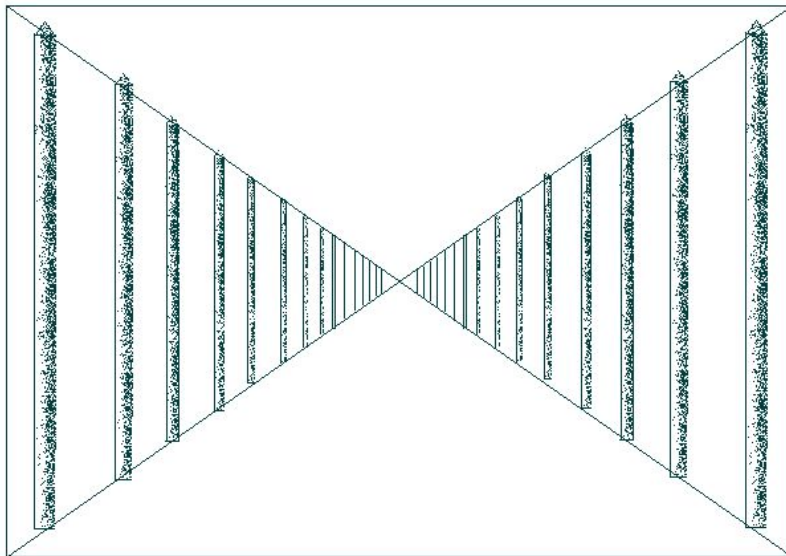

Рис.12

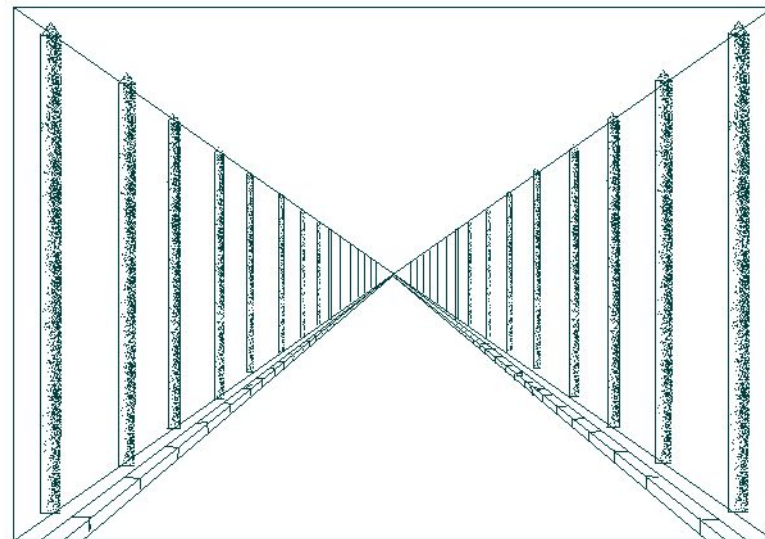

Рис.13

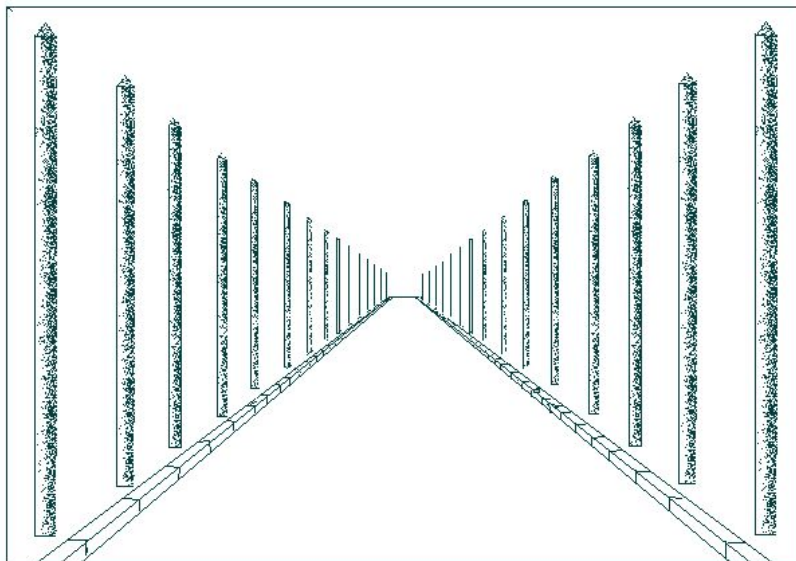

Рис.14

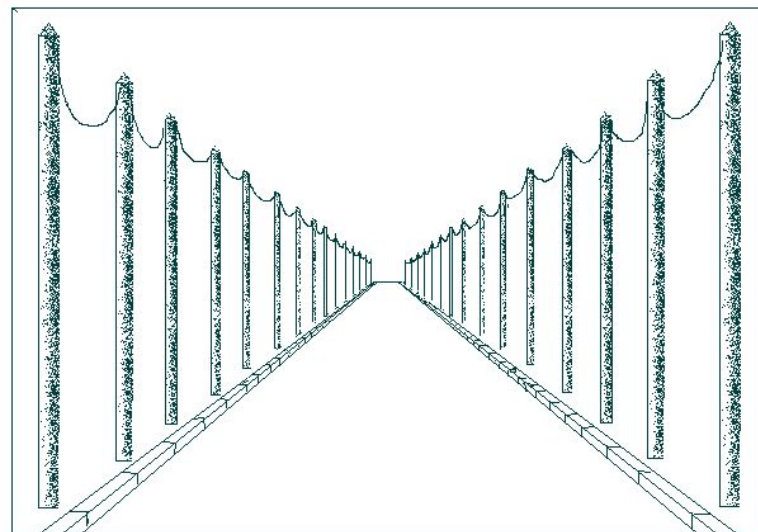

Рис.15

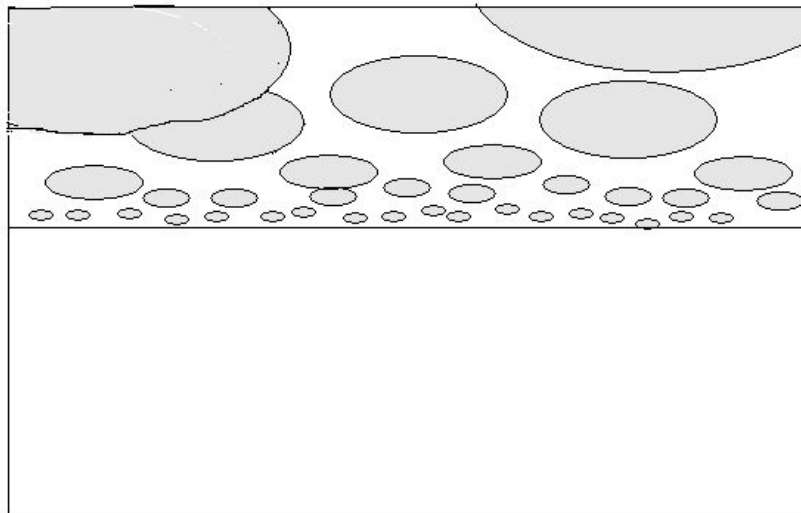

Рис.16

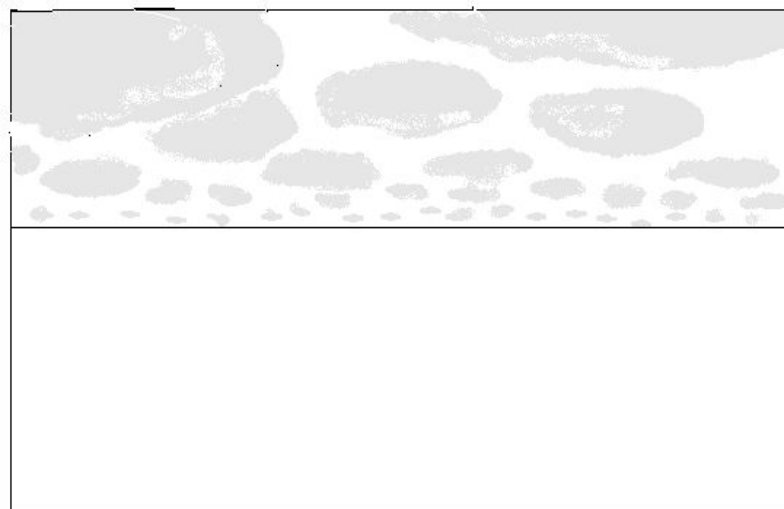

Рис.17

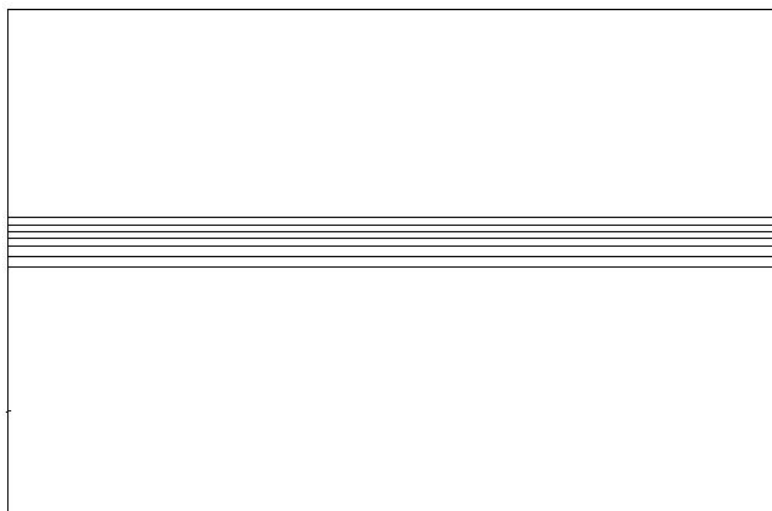

Рис.18

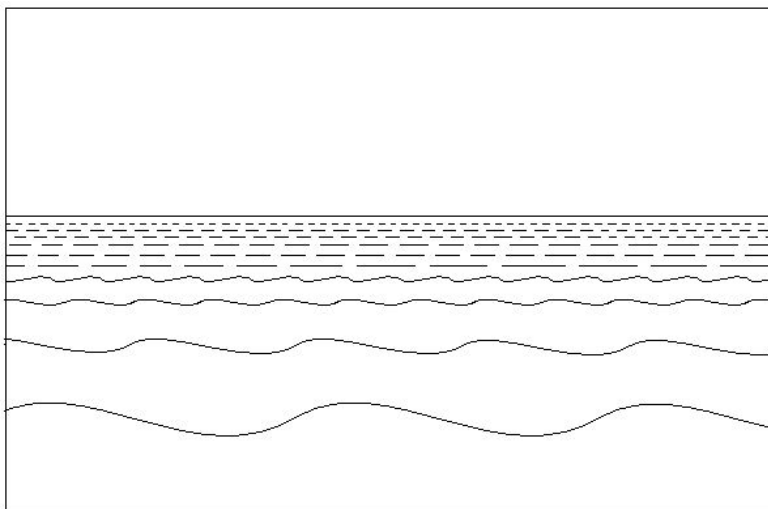

Рис.19

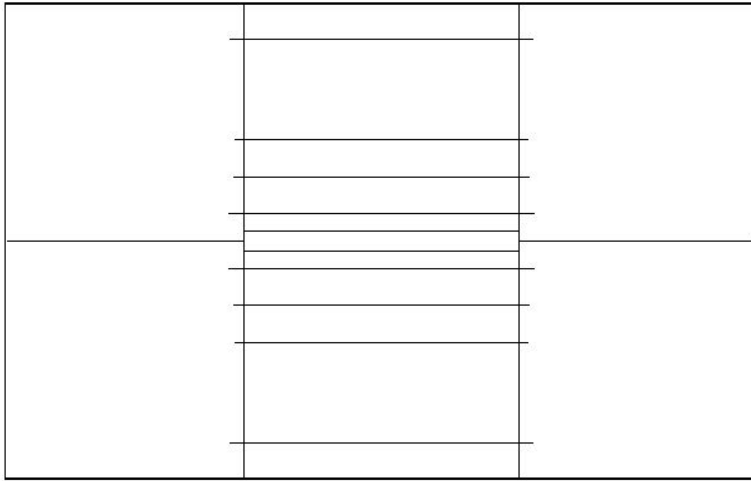

Рис.20

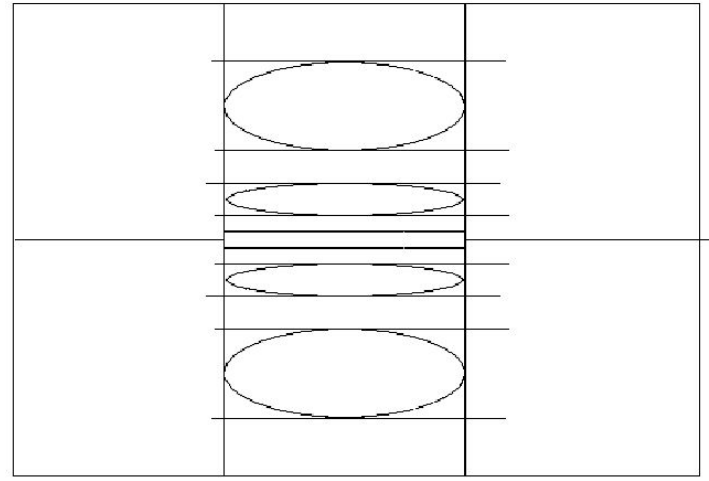

Рис.21

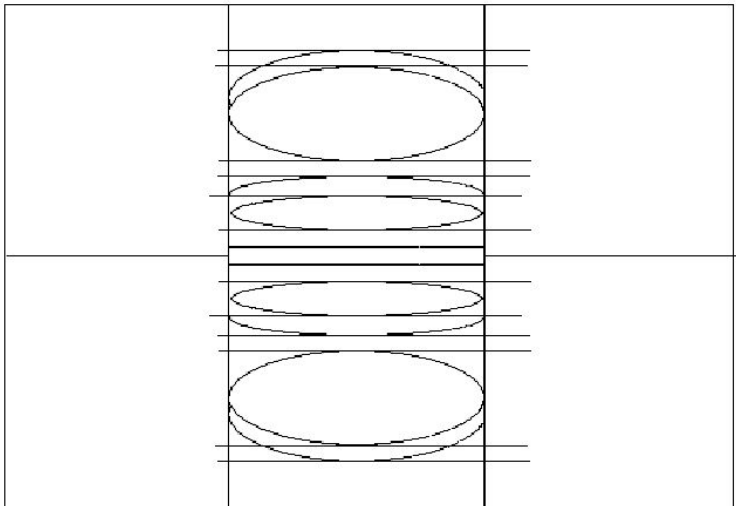

Рис.22

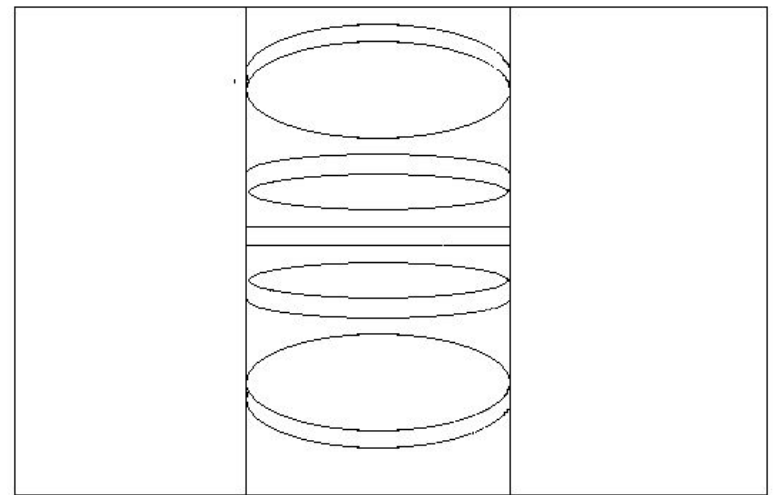

Рис.23

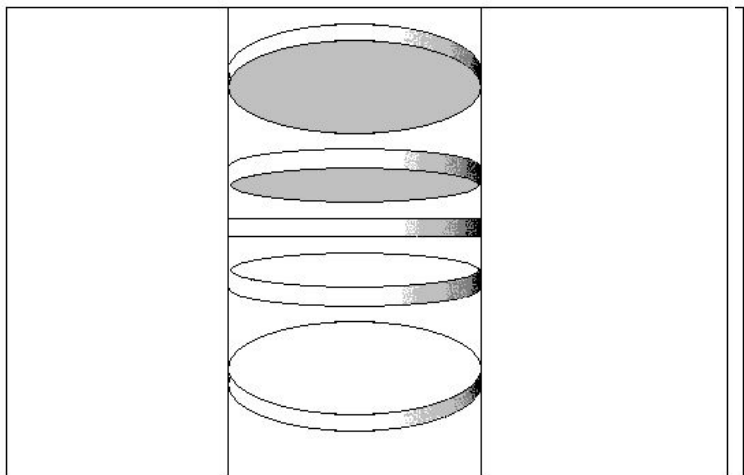

Рис.24

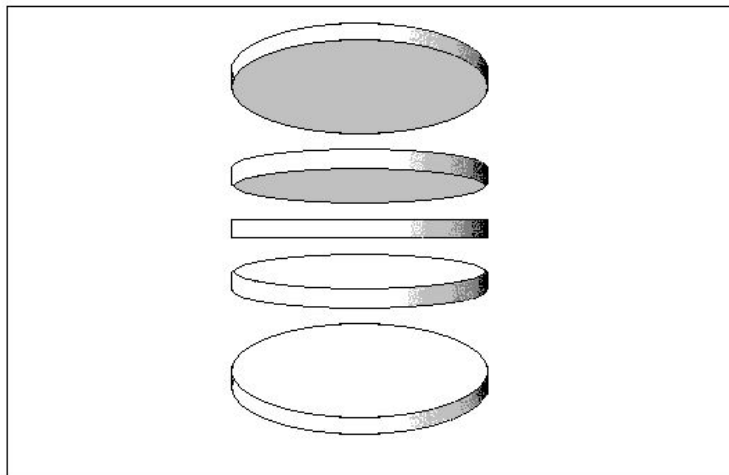

Рис.25

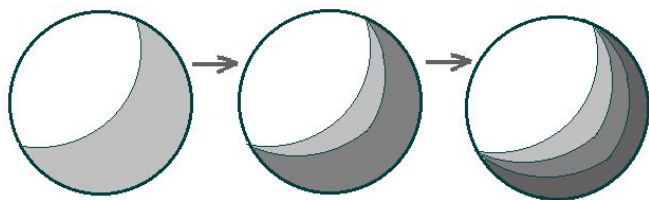

Рис.26

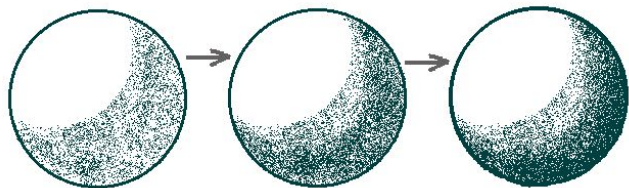

Рис.27

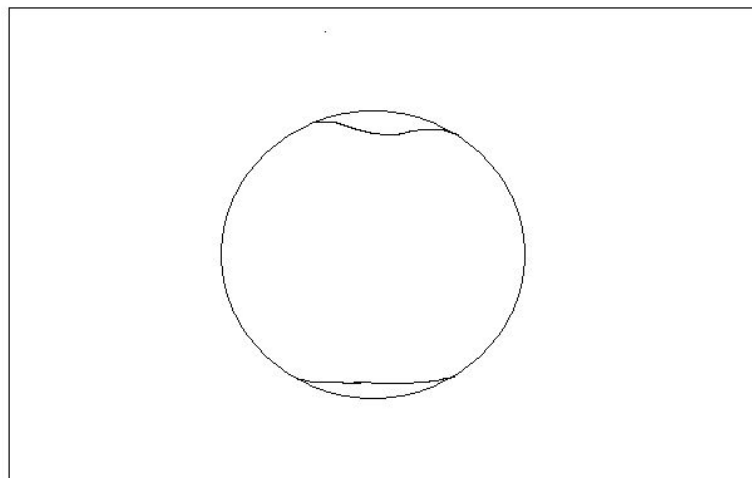

Рис.28

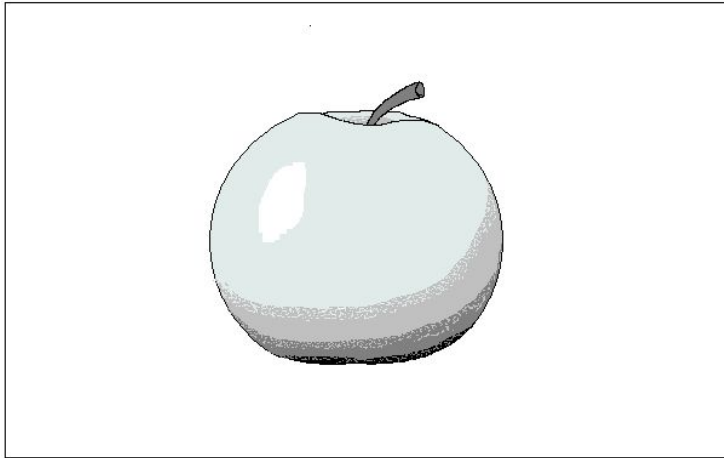

Рис.29

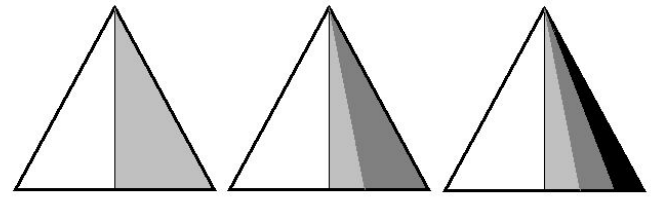

Рис.30

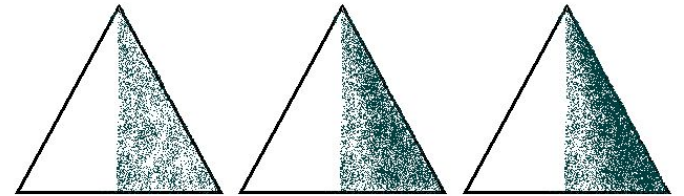

Рис.31

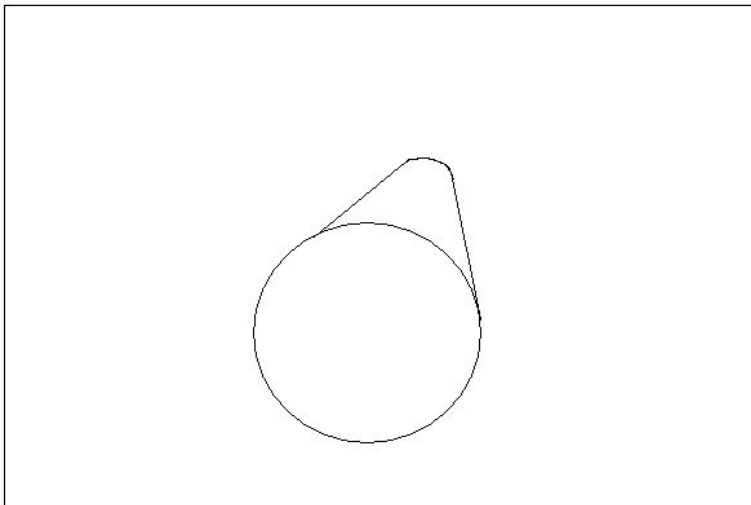

Рис.32

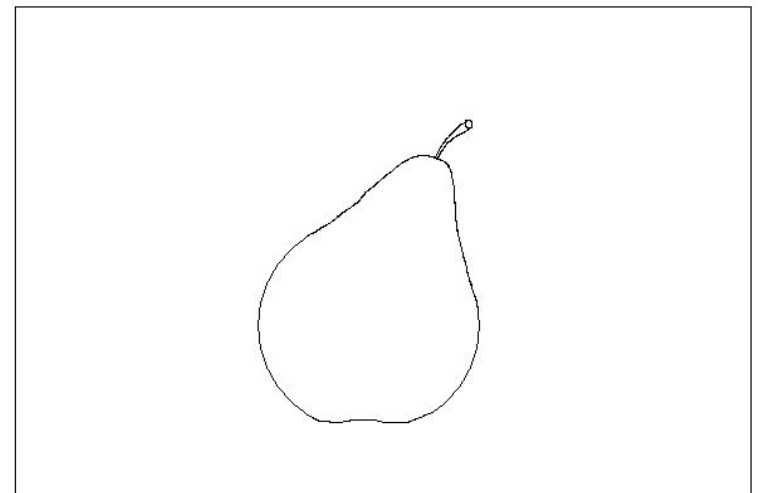

Рис.33

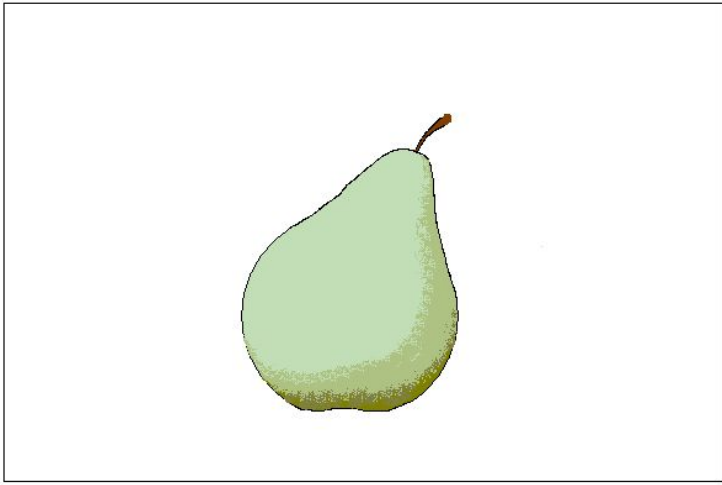

Рис.34

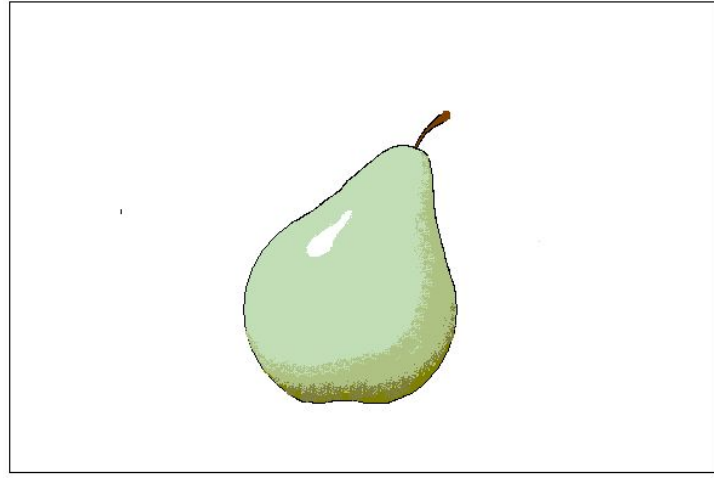

Рис.35



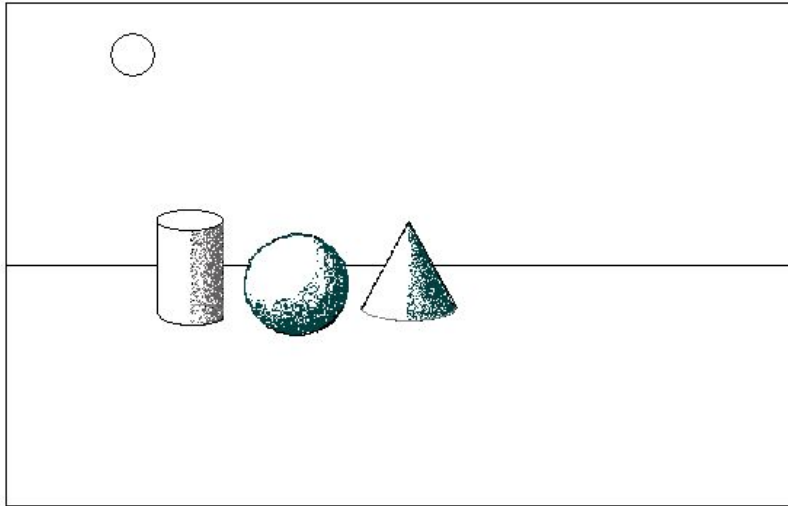

Рис.36

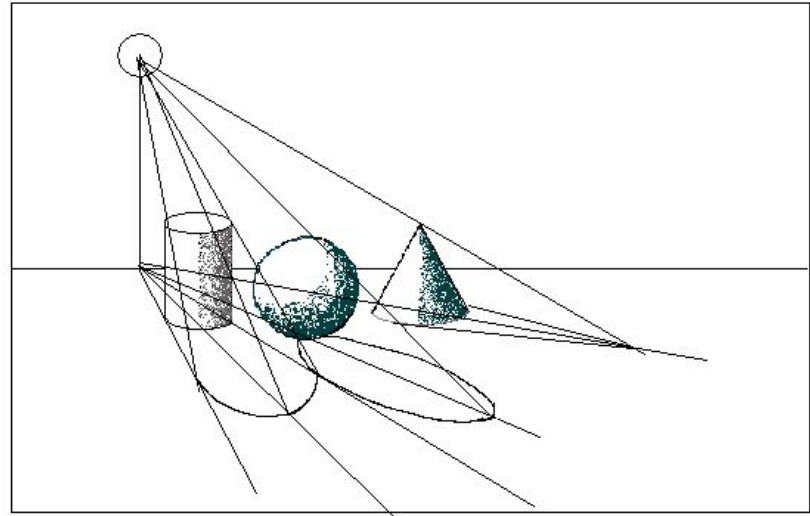

Рис.37

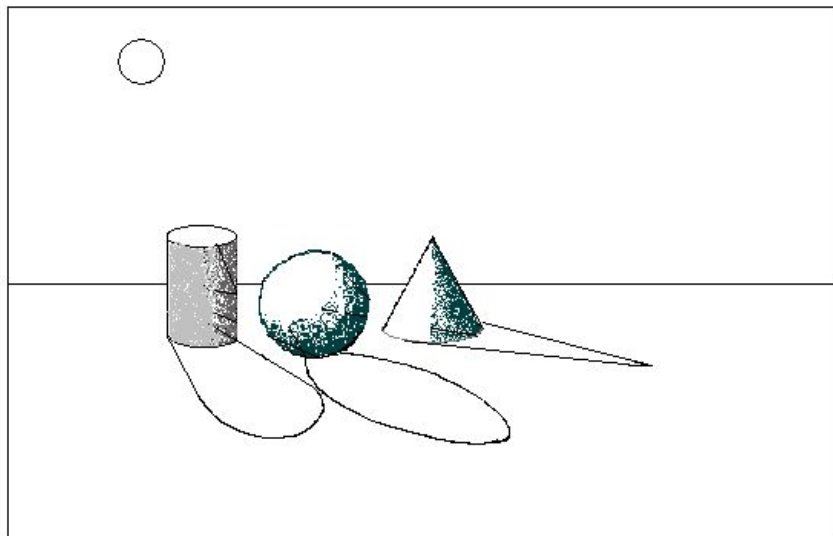

Рис.38

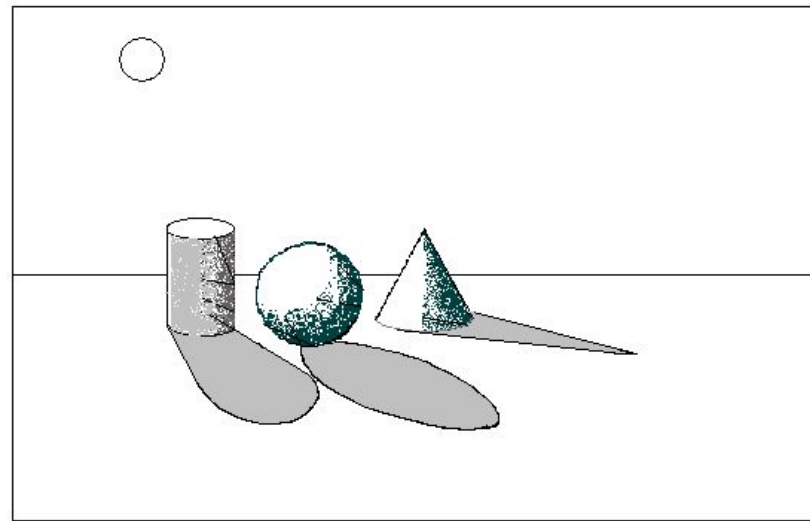

Рис.39

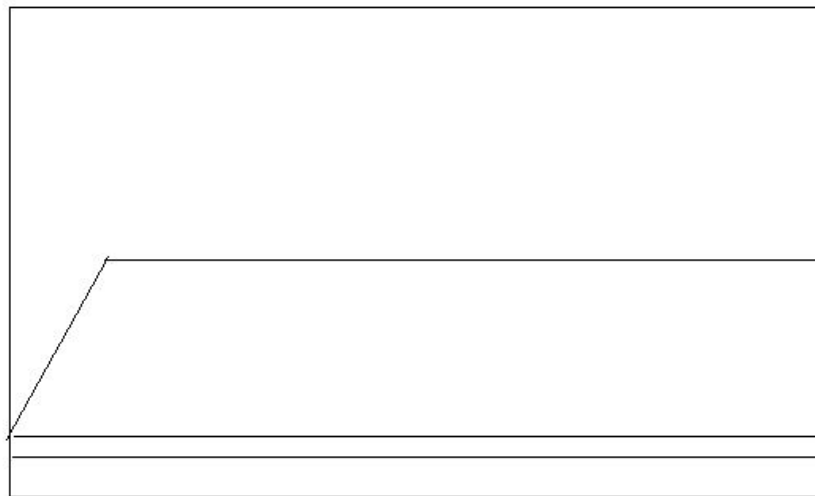

Рис.40

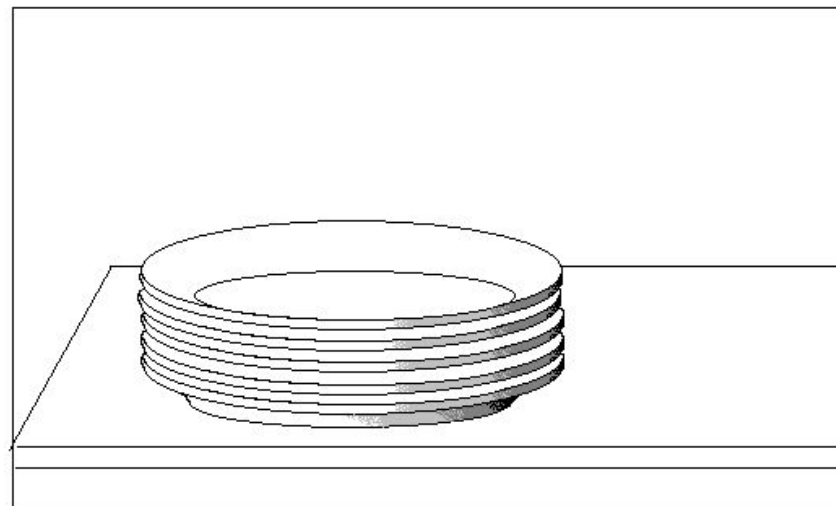

Рис.41

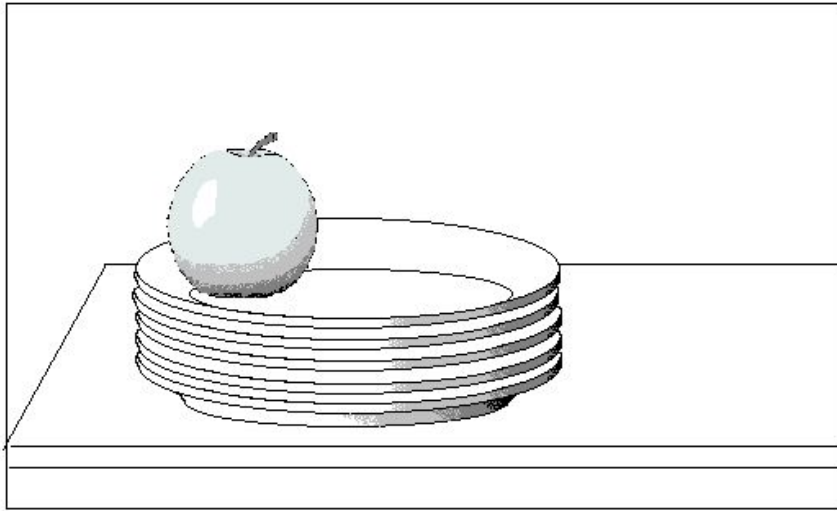

Рис.42

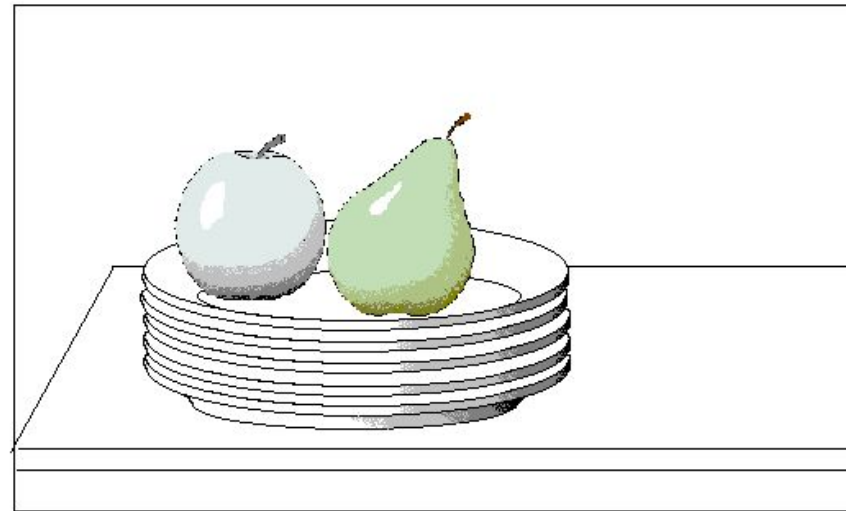

Рис.43

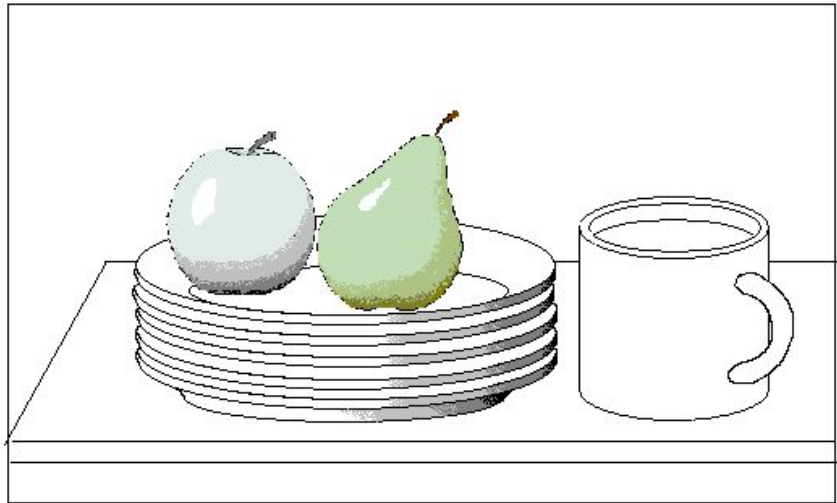

Рис.44

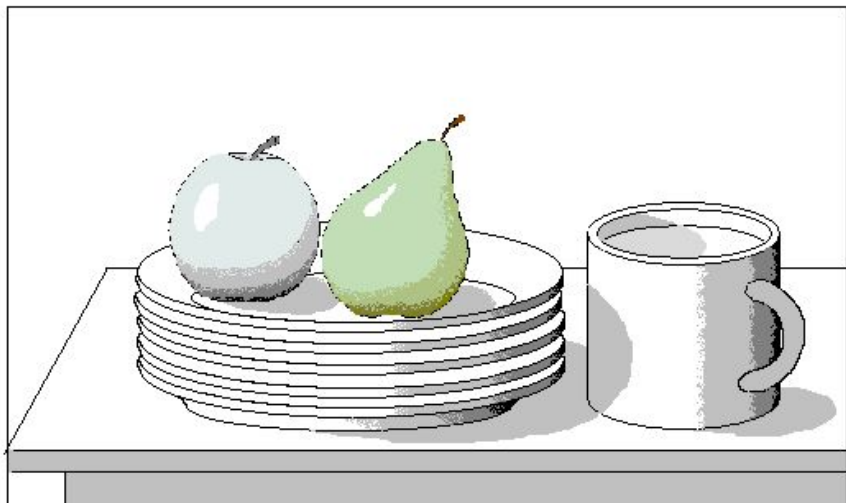

Рис.45

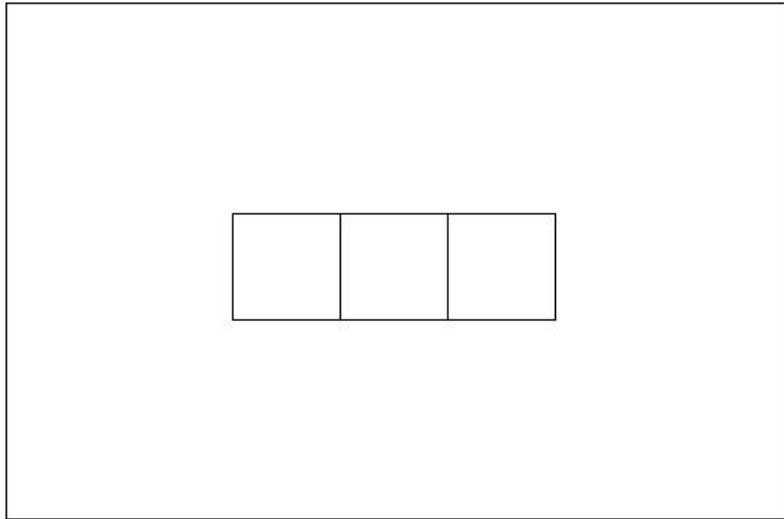

Рис.46

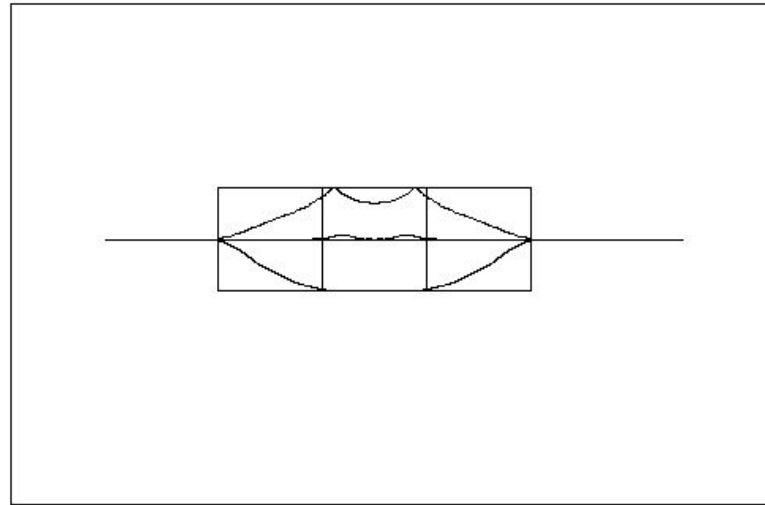

Рис.47

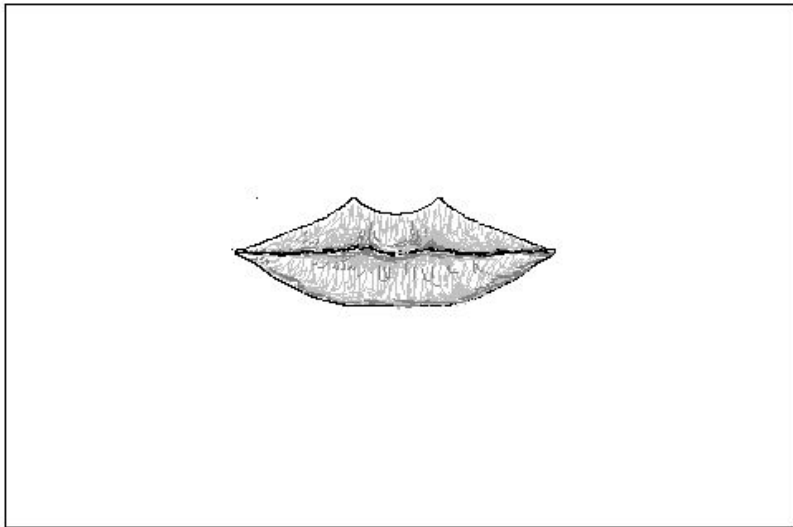

Рис.48

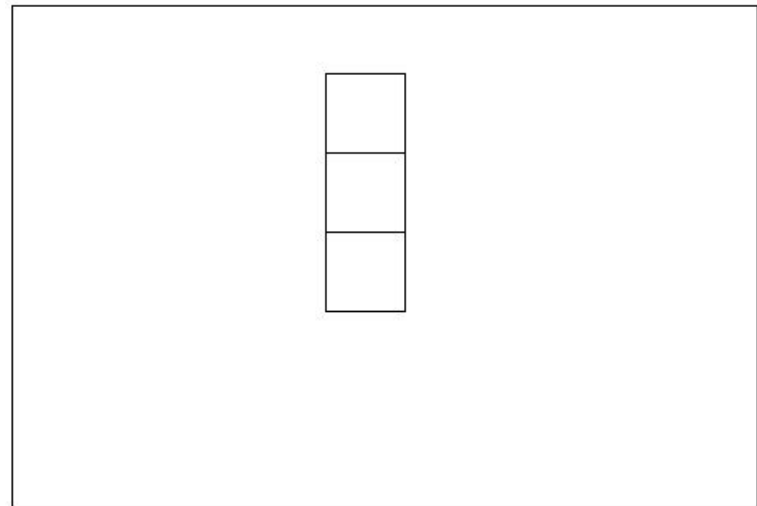

Рис.49

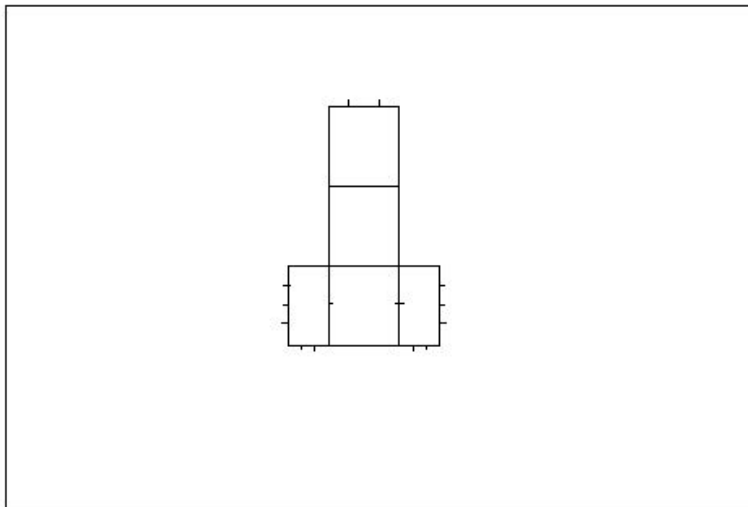

Рис.50

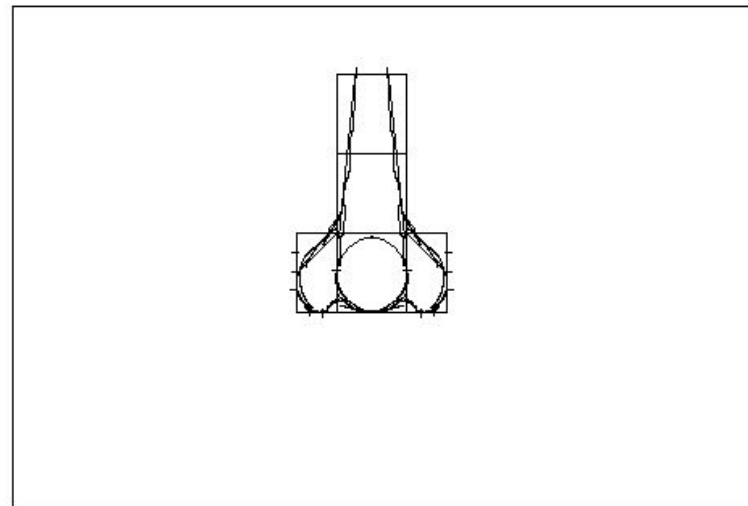

Рис.51

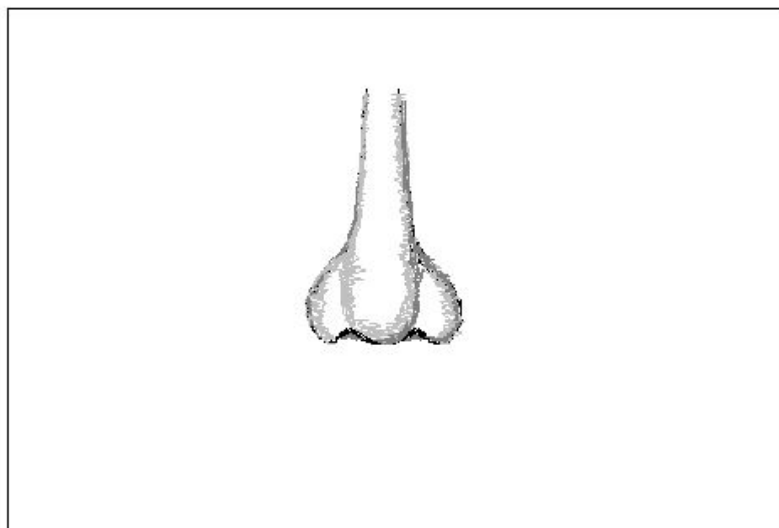

Рис.52

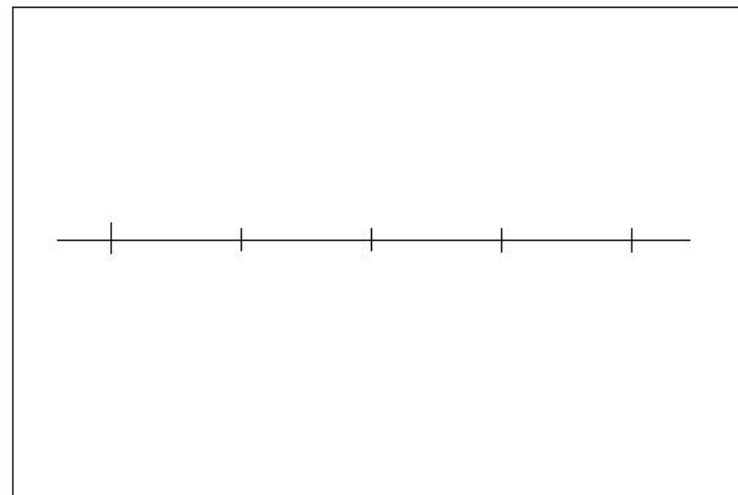

Рис.53

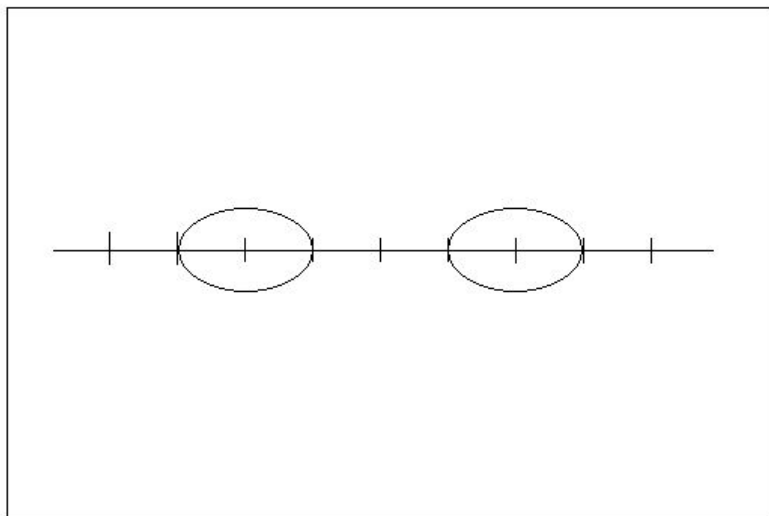

Рис.54

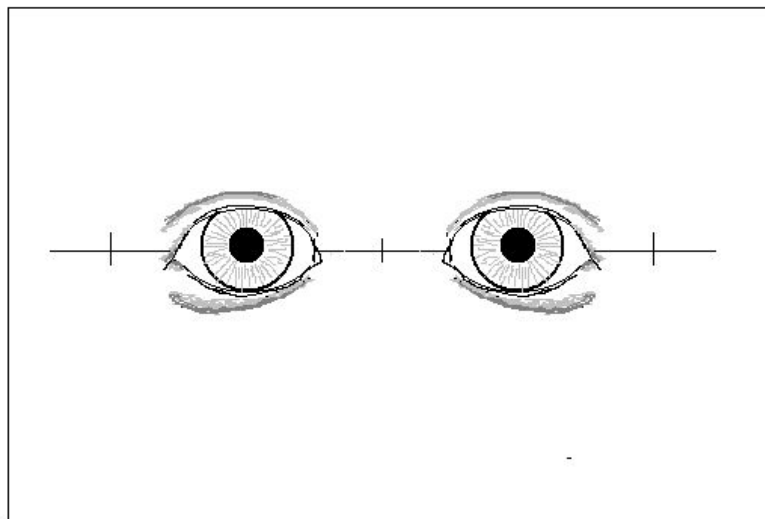

Рис.55

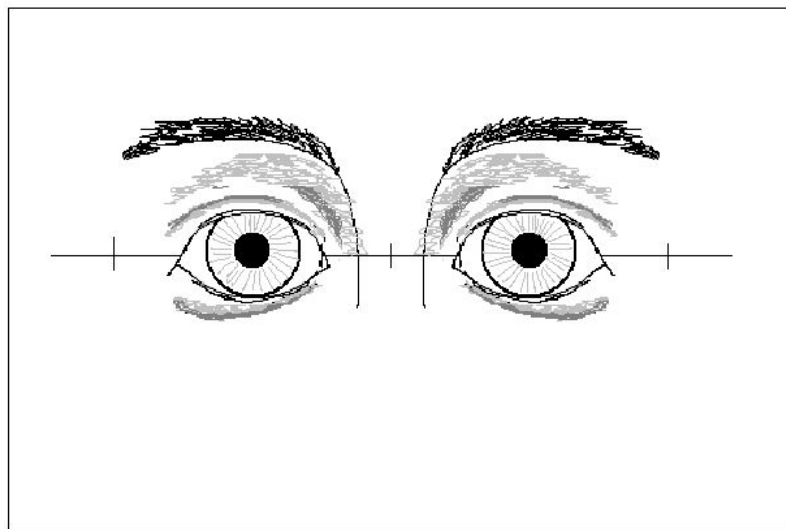

Рис.56

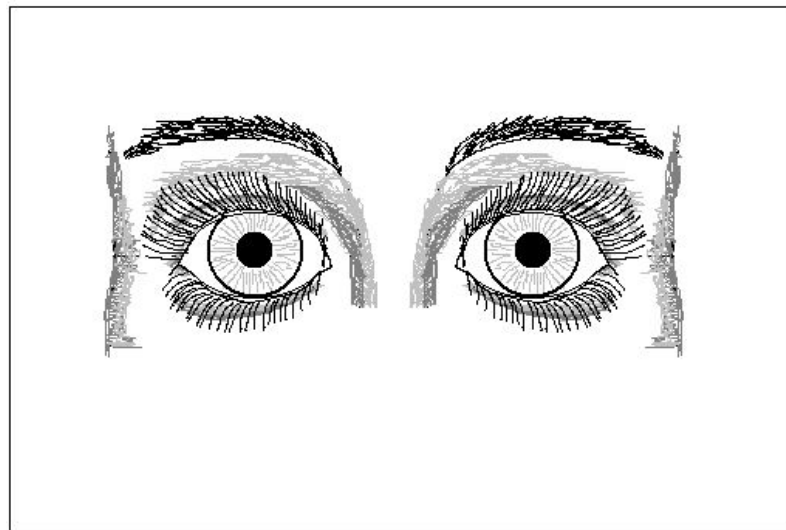

Рис.57

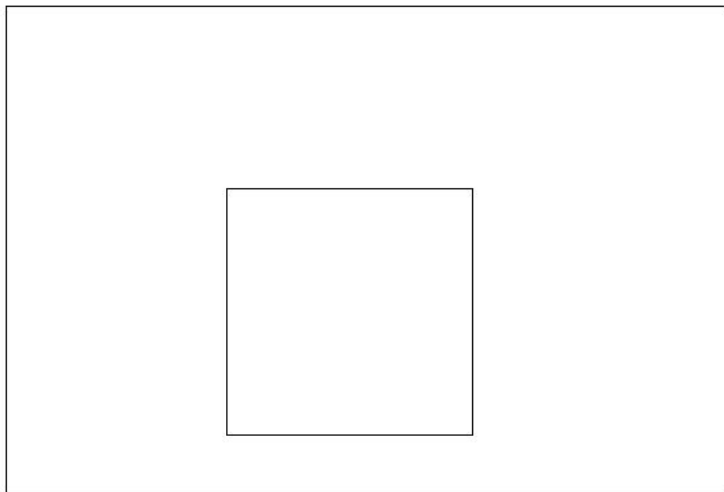

Рис.58



Рис.59

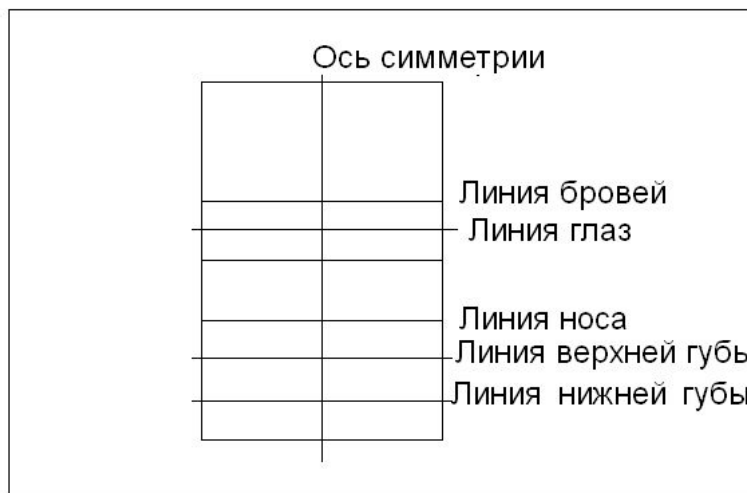

Рис.60

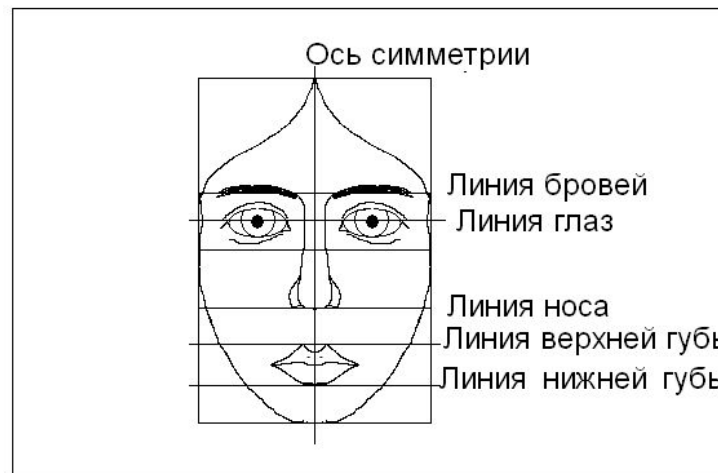

Рис.61

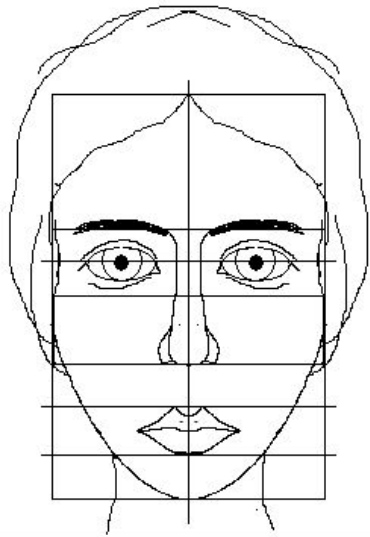

Рис.62

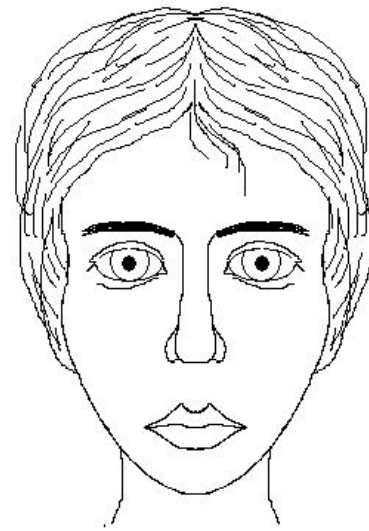

Рис.63



Рис.64

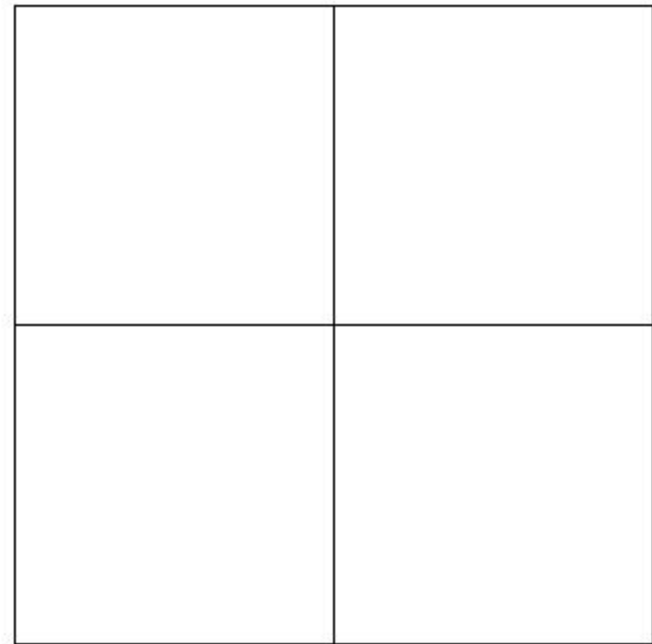

Рис.65

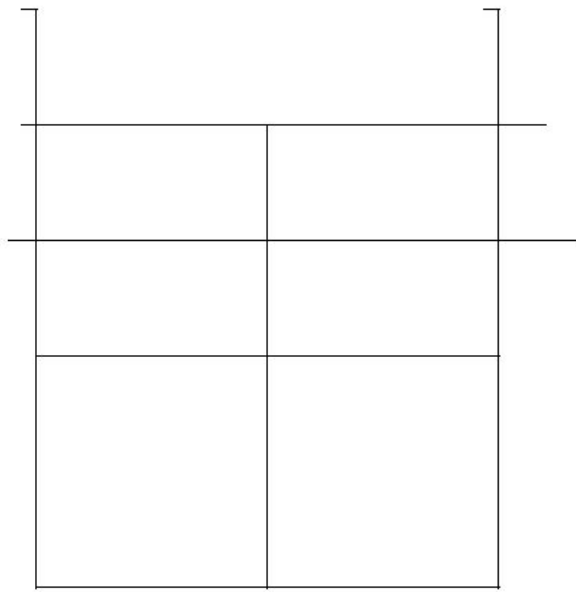

Рис.66

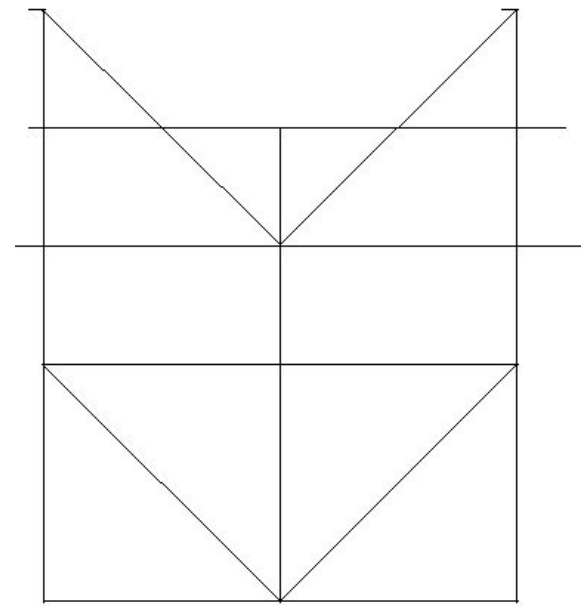

Рис.67



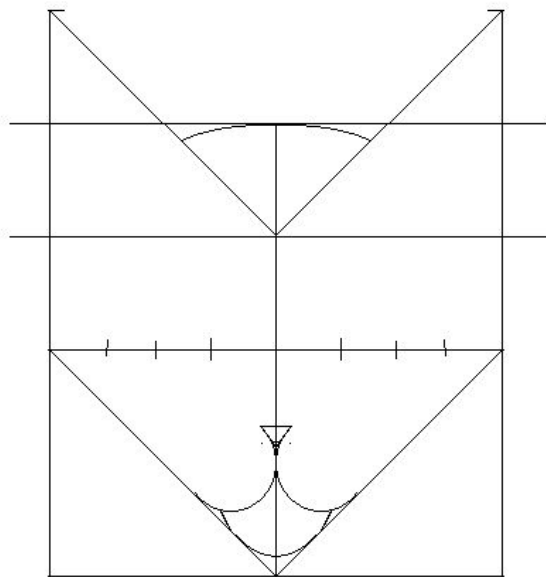

Рис.68

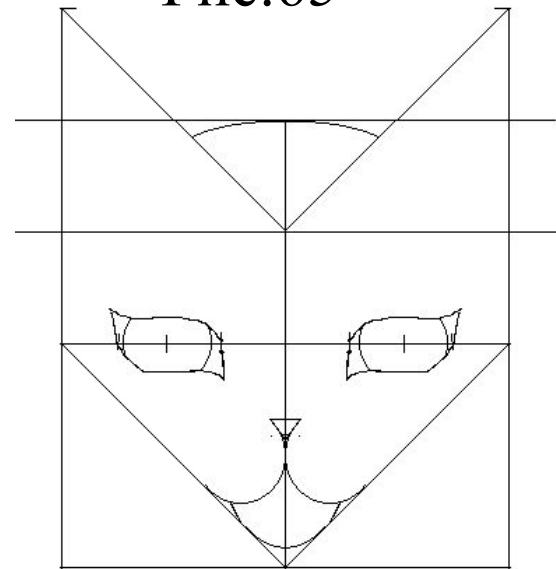

Рис.69

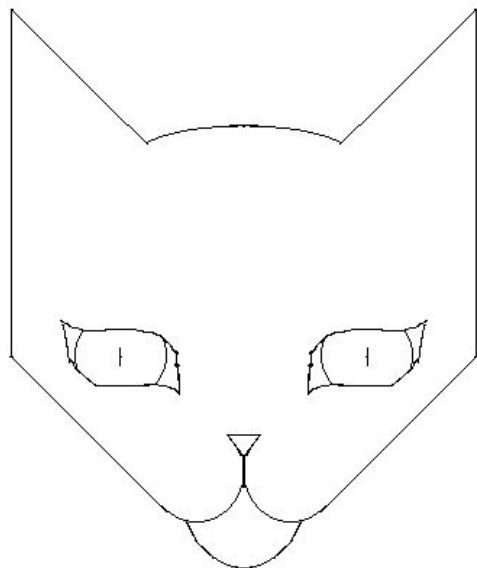

Рис.70

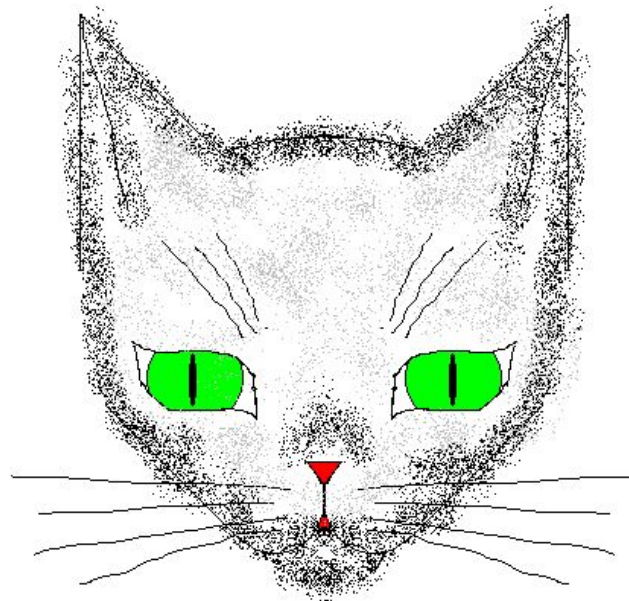

Рис.71

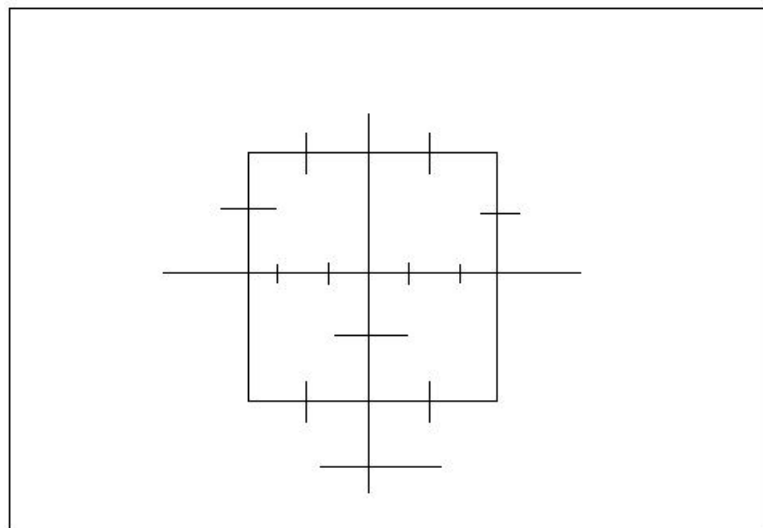

Рис.72

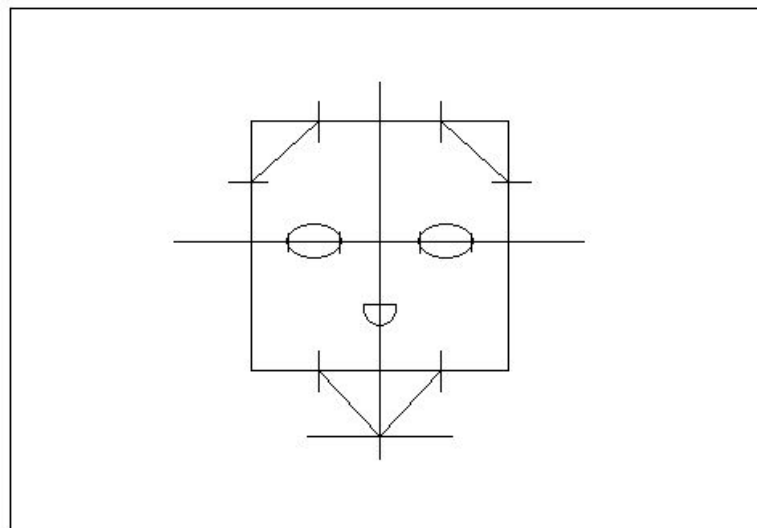

Рис.73

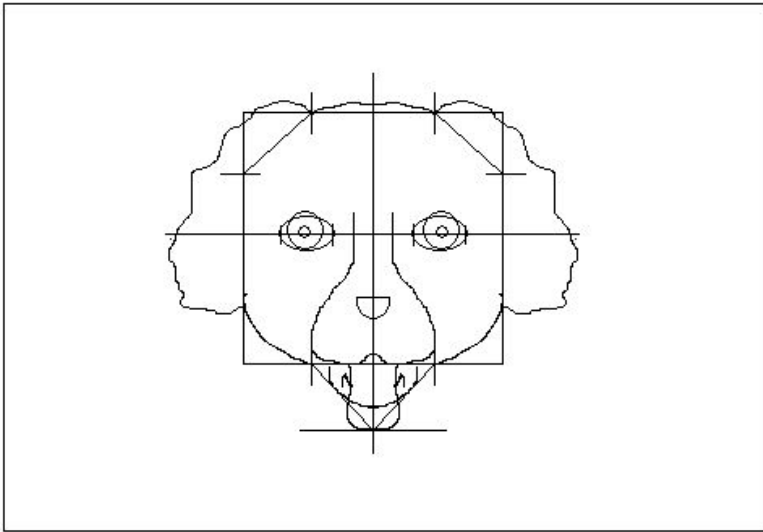

Рис.74

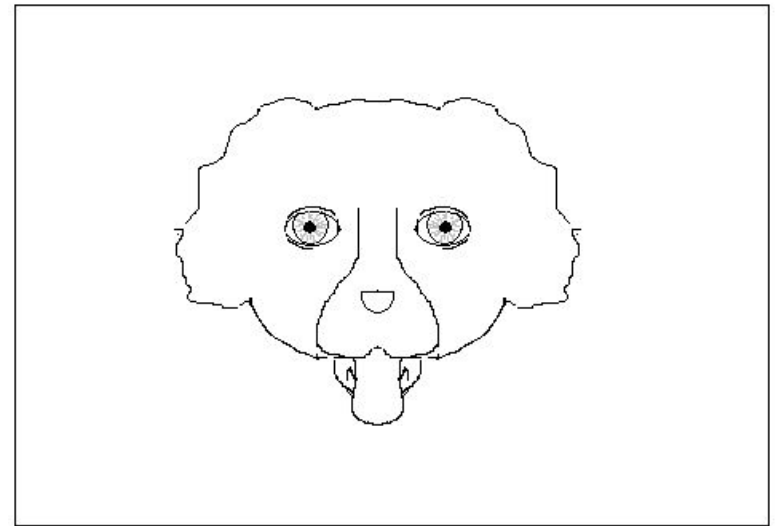

Рис.75

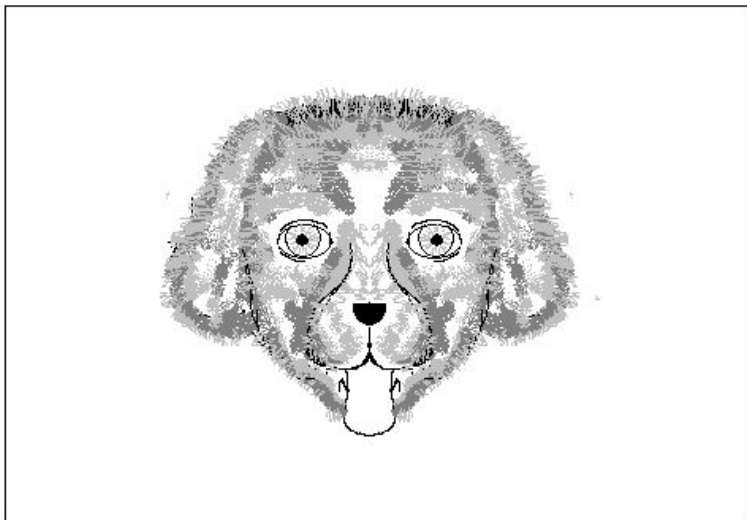

Рис.76

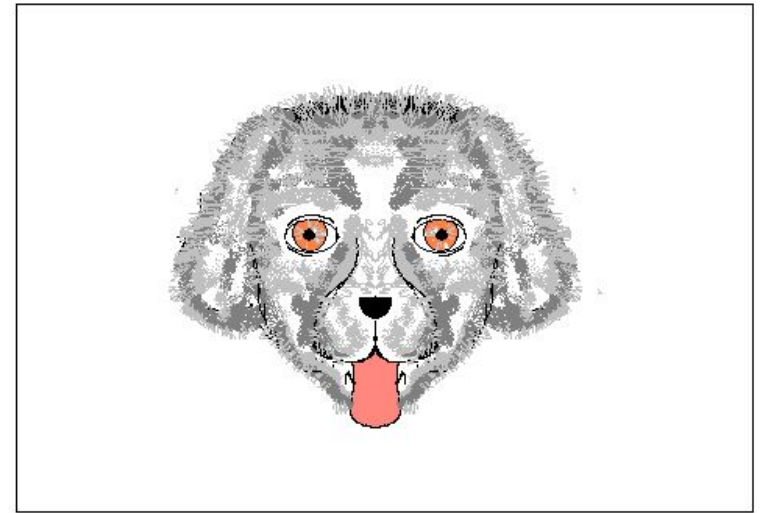

Рис.77

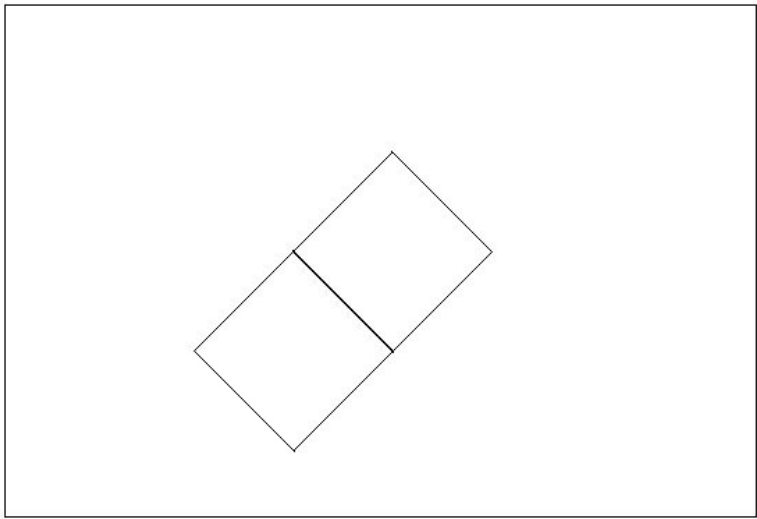

Рис.78

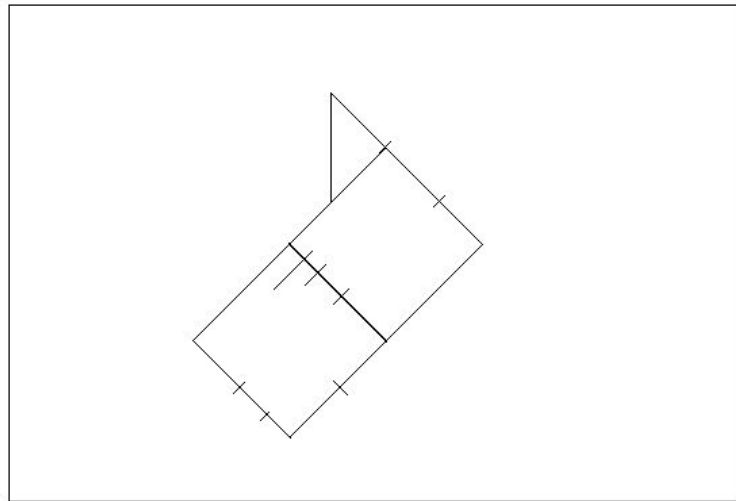

Рис.79

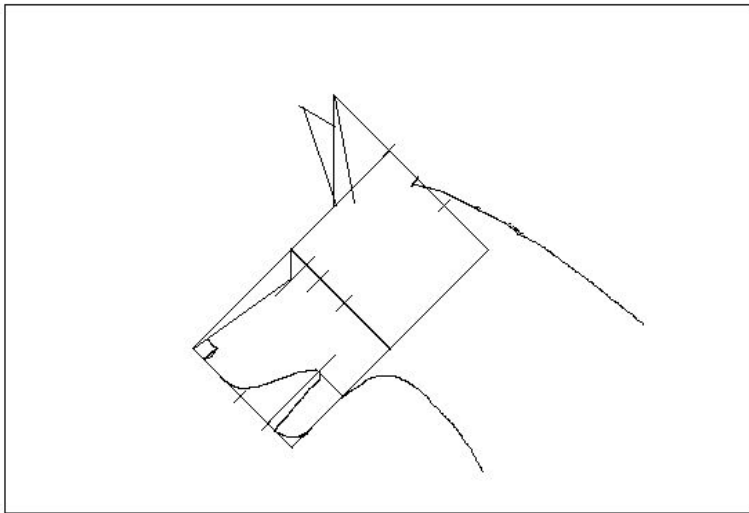

Рис.80

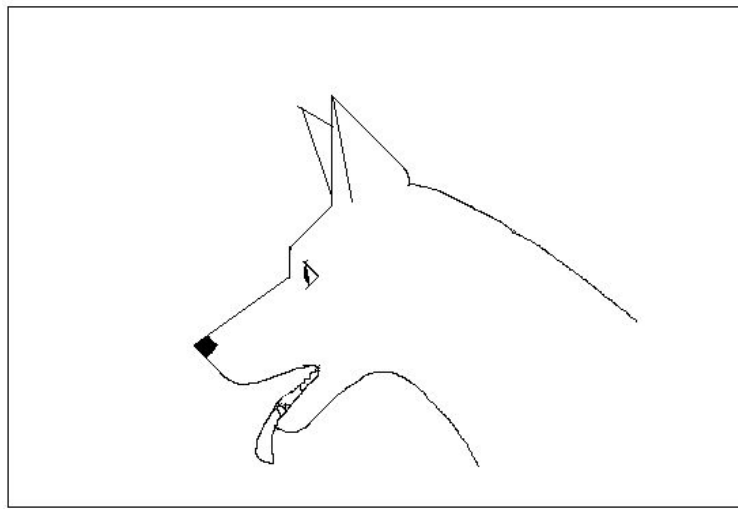

Рис.81

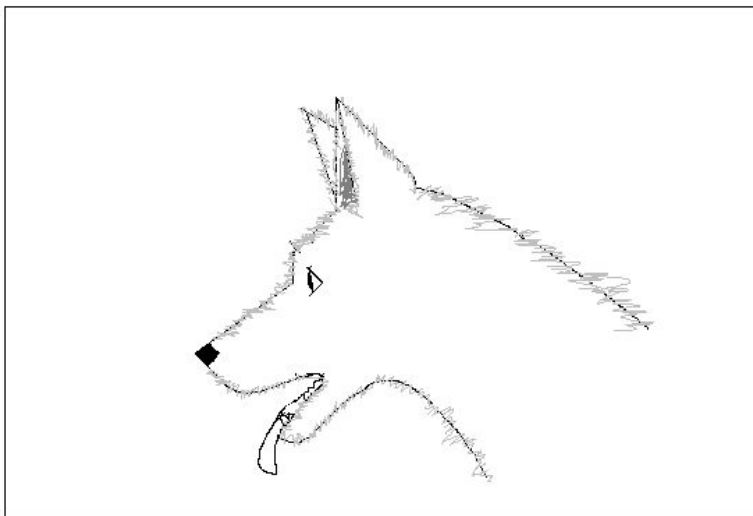

Рис.82

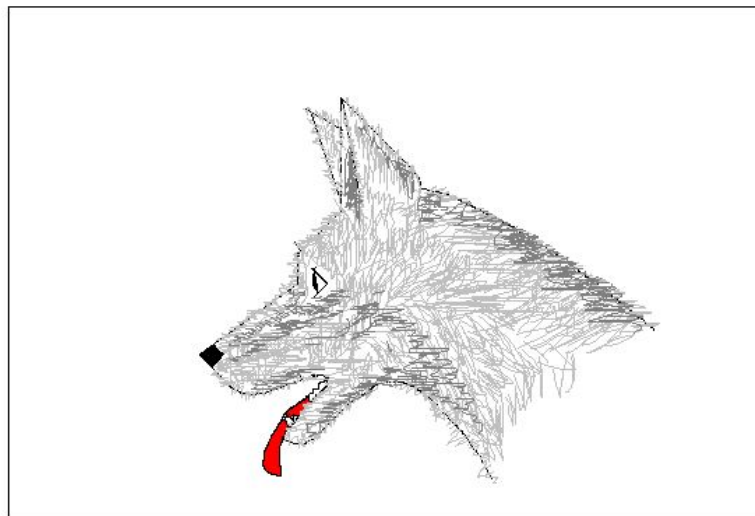

Рис.83

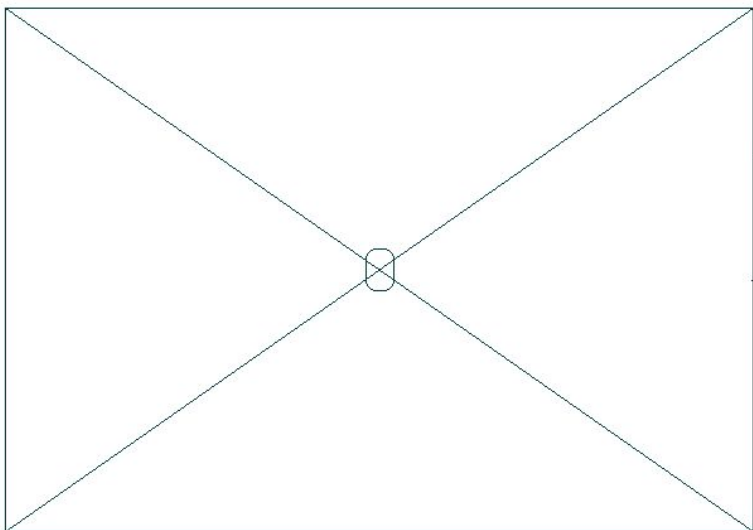

Рис.84

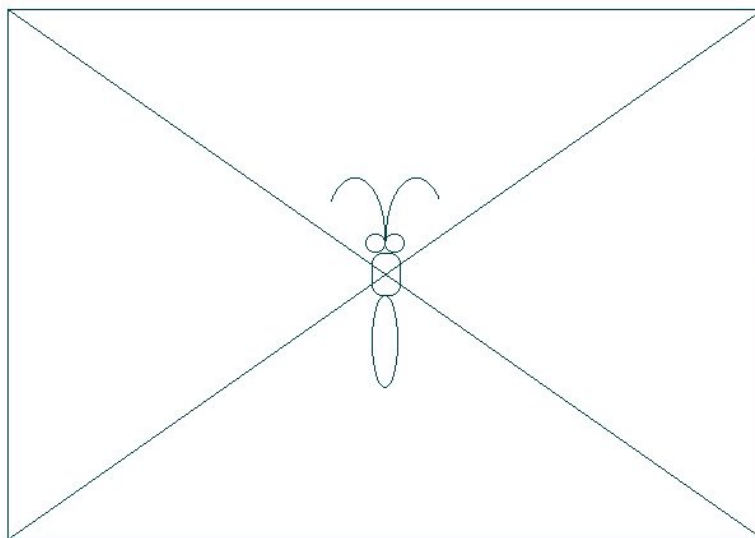

Рис.85

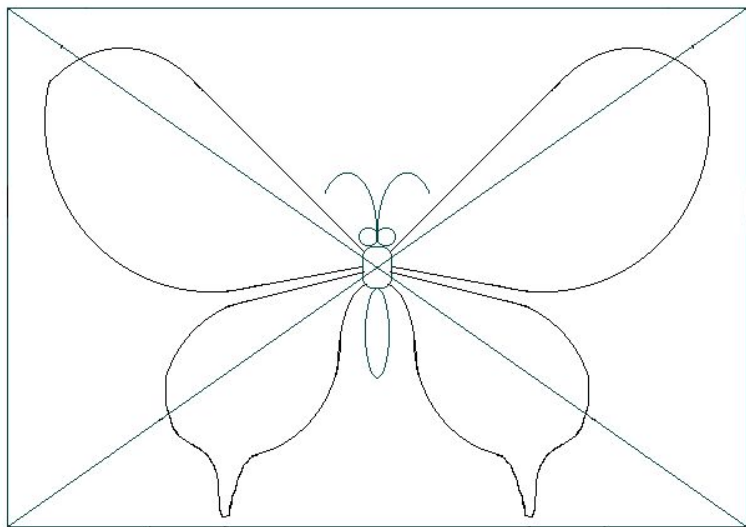

Рис.86

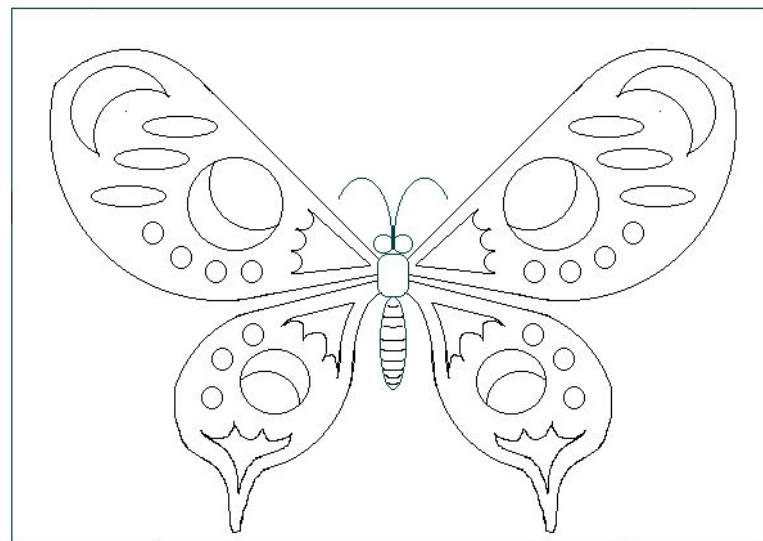

Рис87

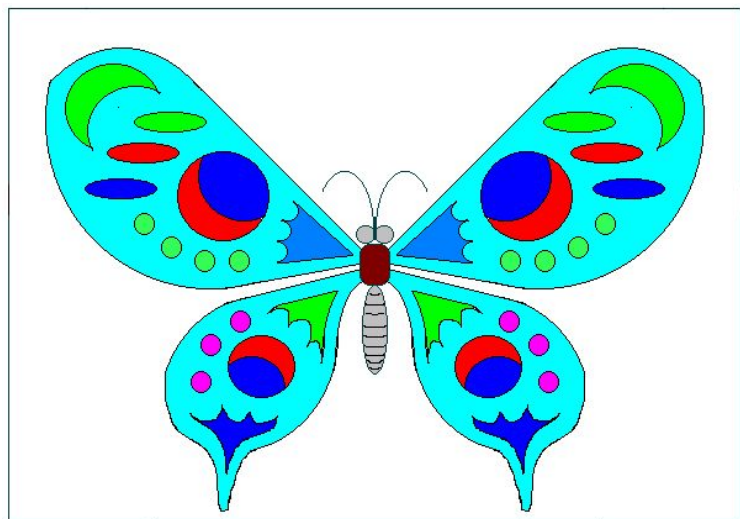

Рис.88

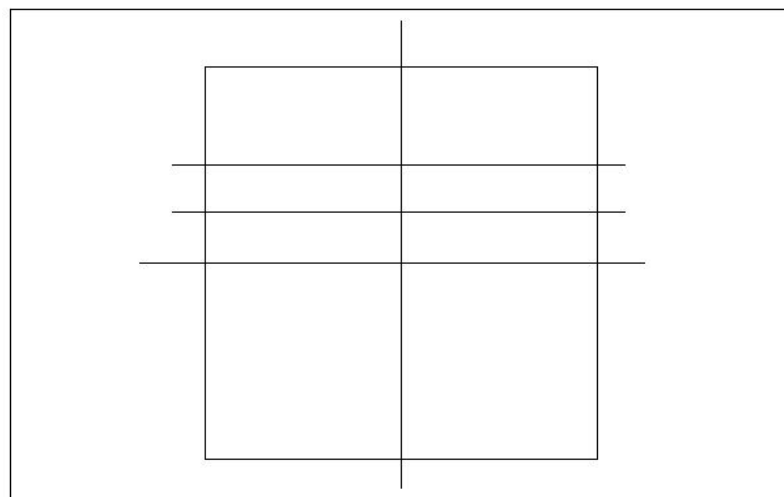

Рис.89

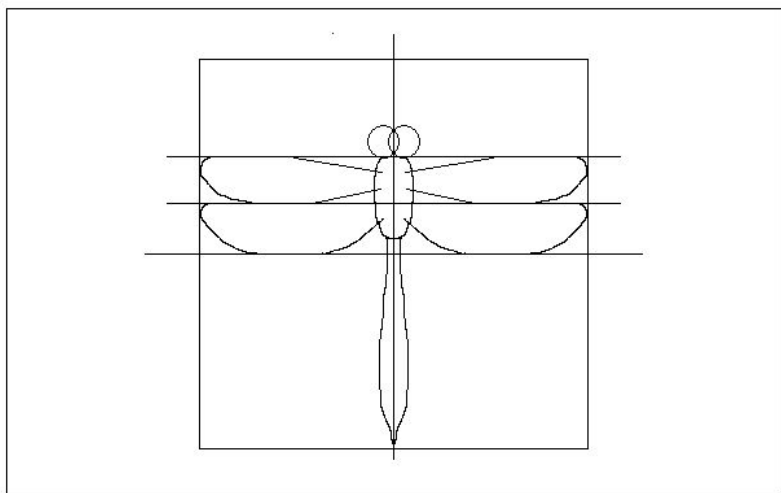

Рис.90

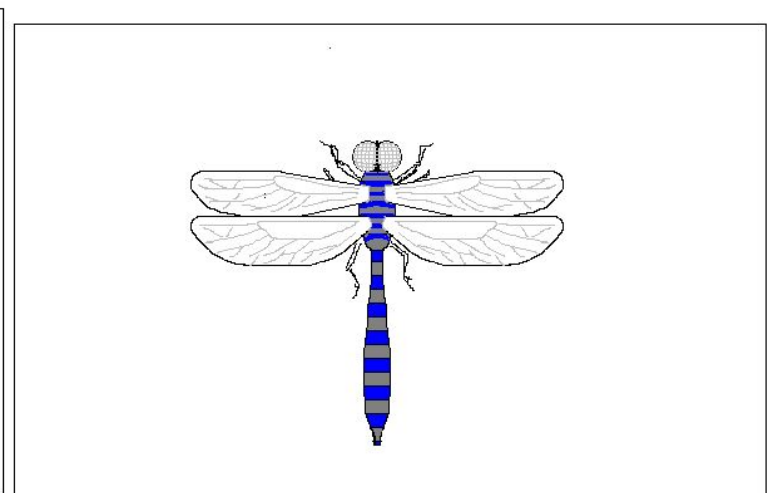

Рис.91



Рис.92

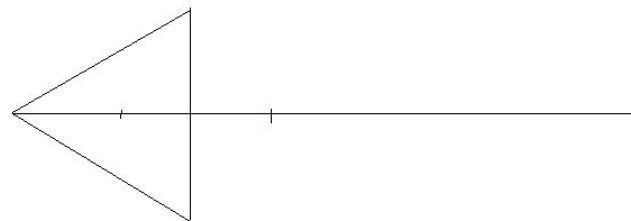

Рис.93

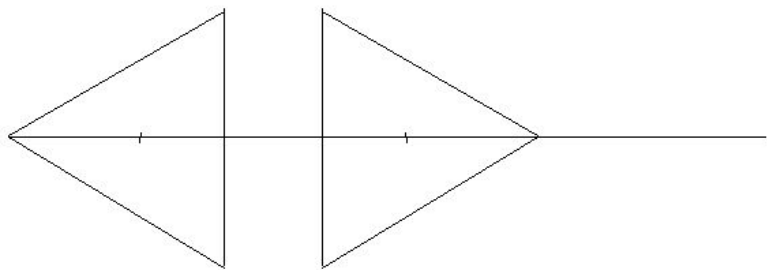

Рис.94

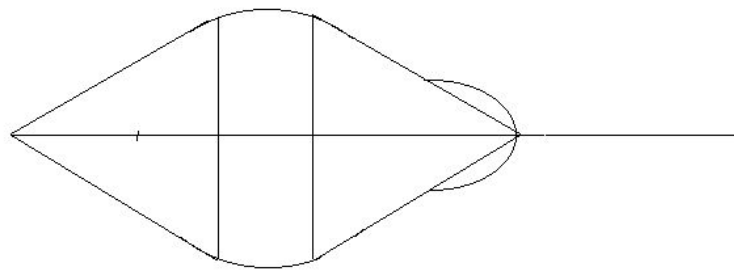

Рис95

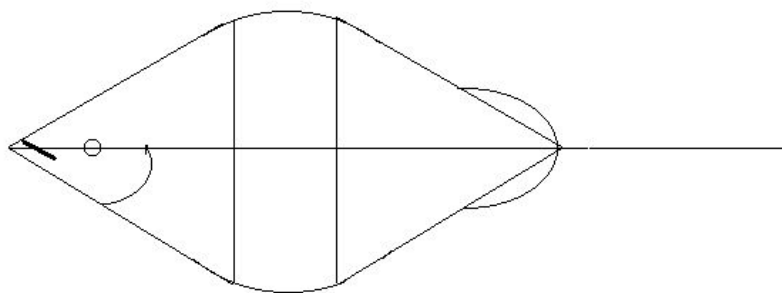

Рис.96

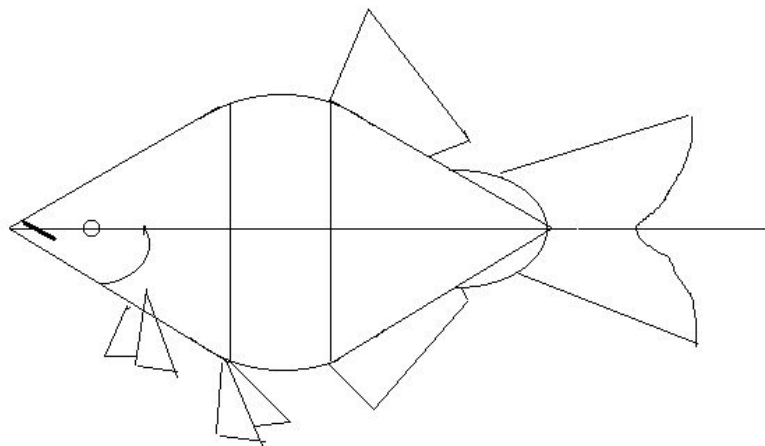

Рис.97

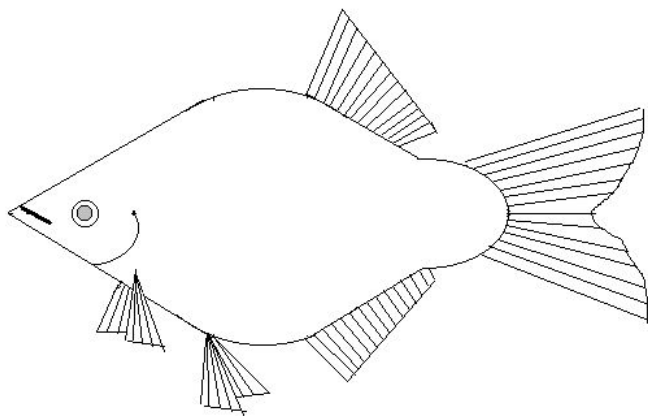

Рис.98

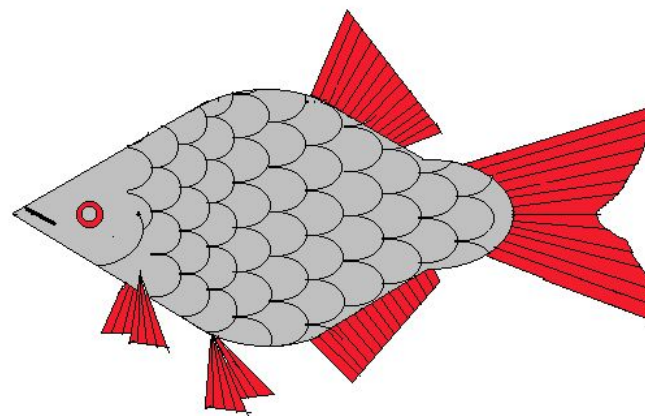

Рис.99



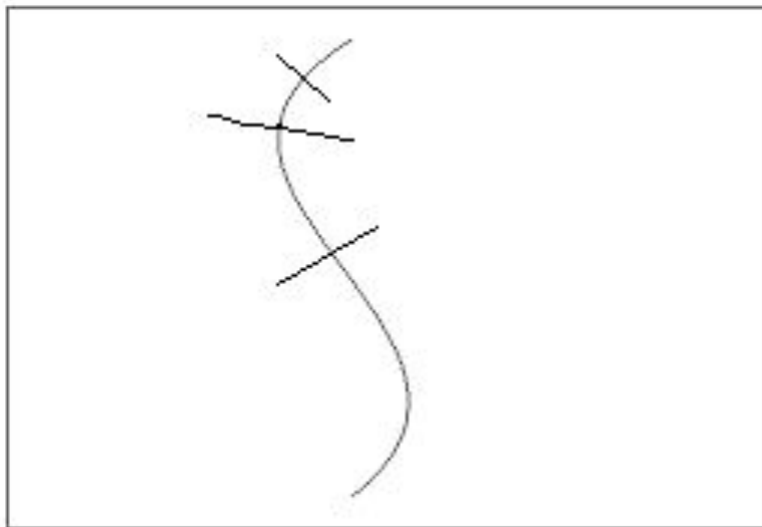

Рис.100

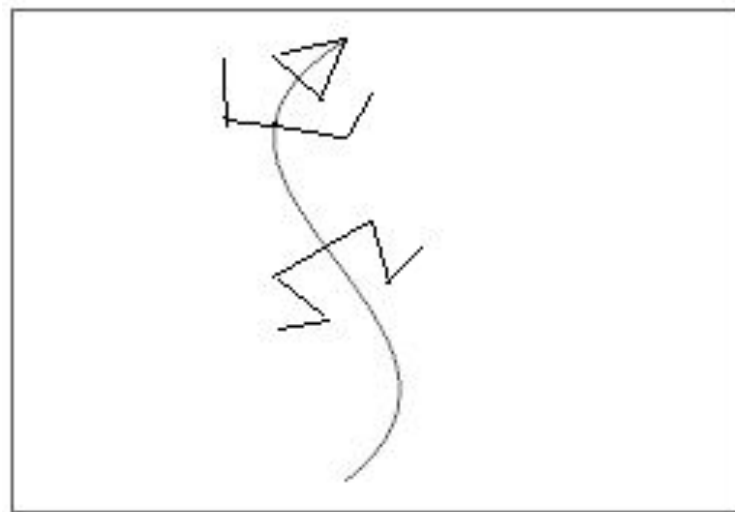

Рис.101

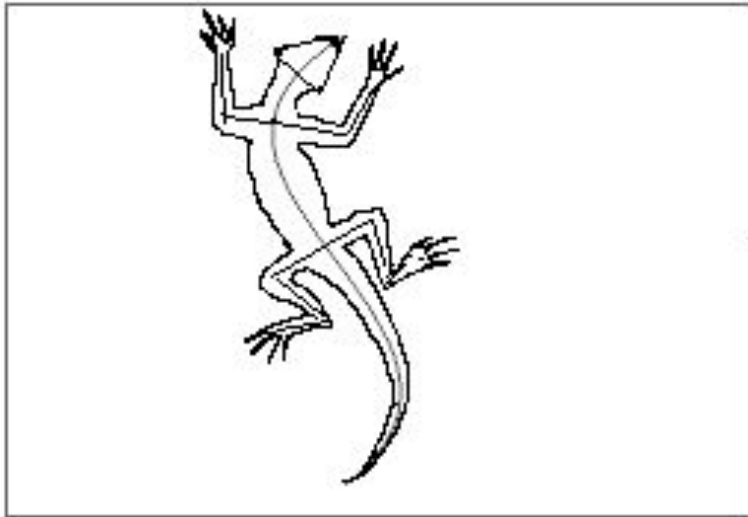

Рис102

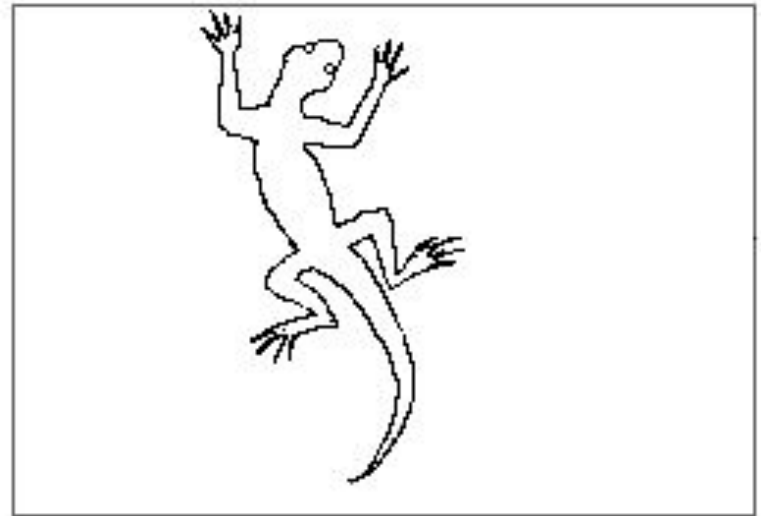

Рис.103

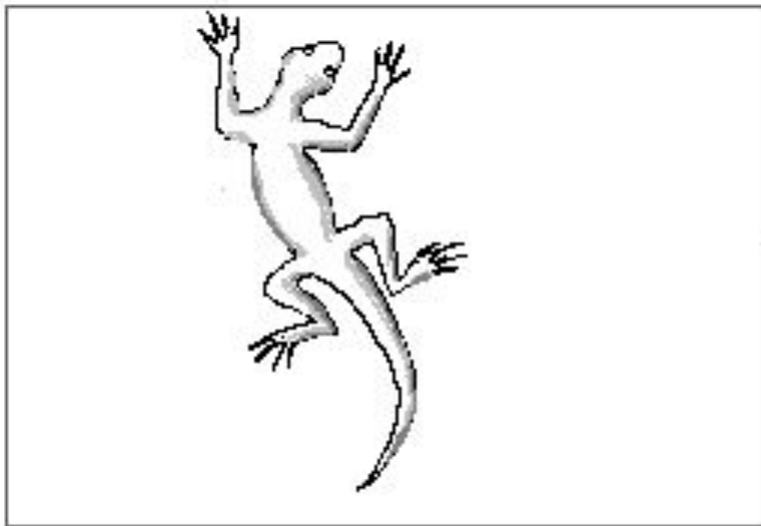

Рис.104

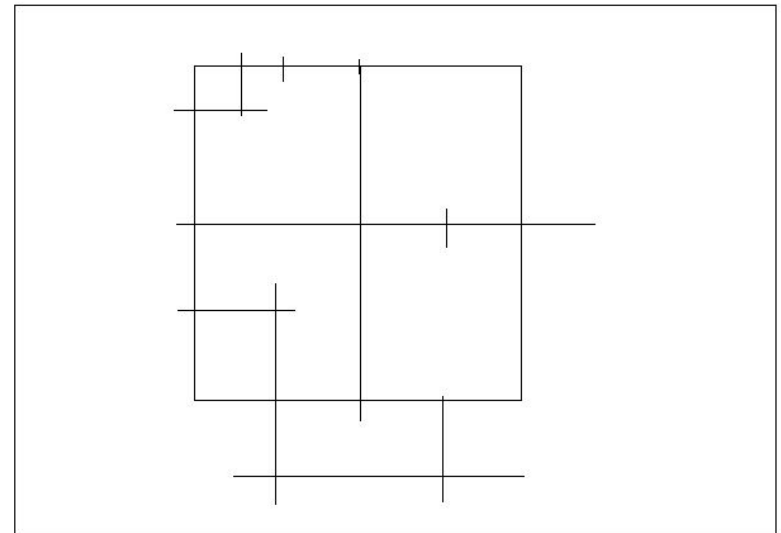

Рис.105

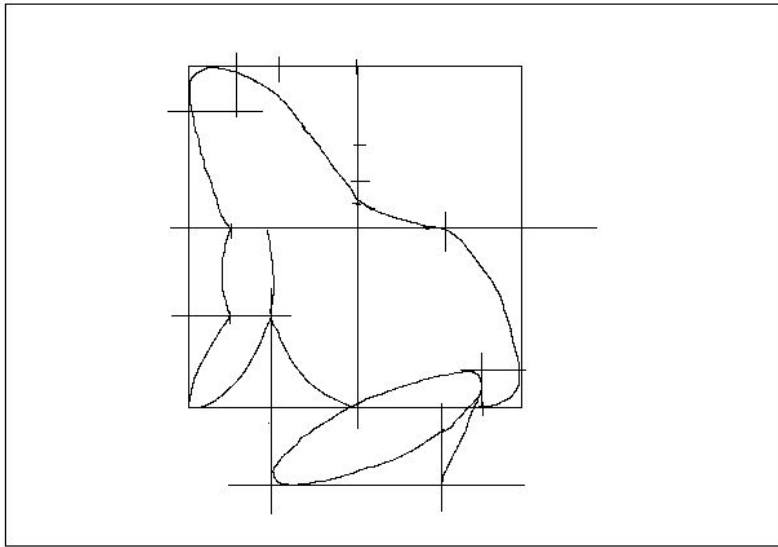

Рис.106

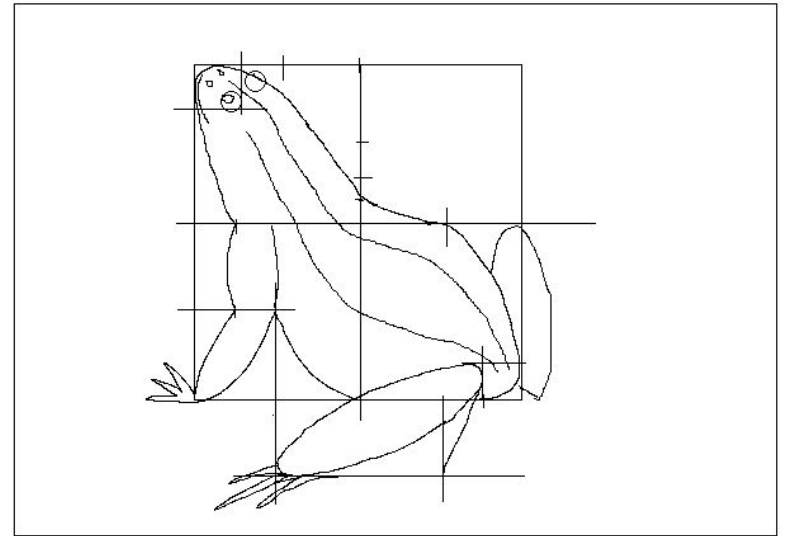
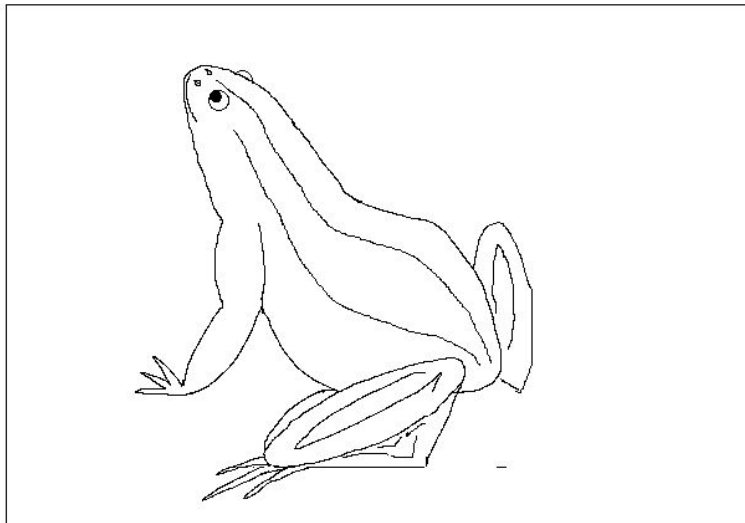
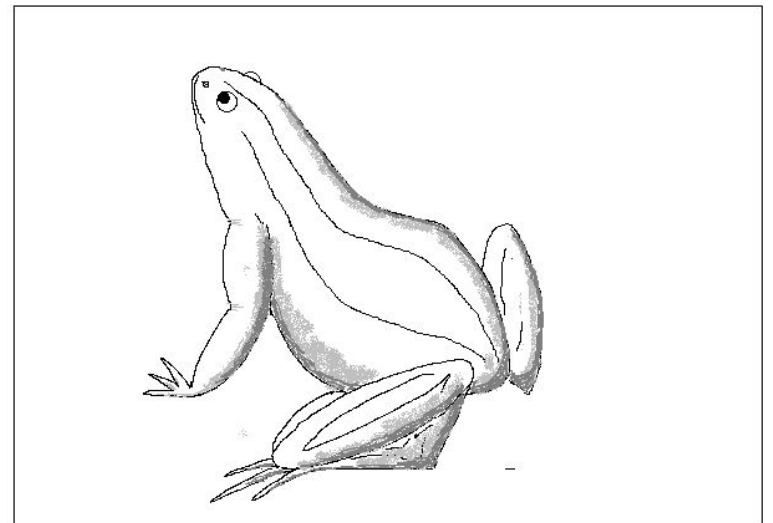

Рис.107