

Урок геометрии в 10 классе  
по теме  
«Задачи на построение сечений  
тетраэдра и параллелепипеда»

(Учебник: Атанасян Л.С и др. Геометрия, 10-11)

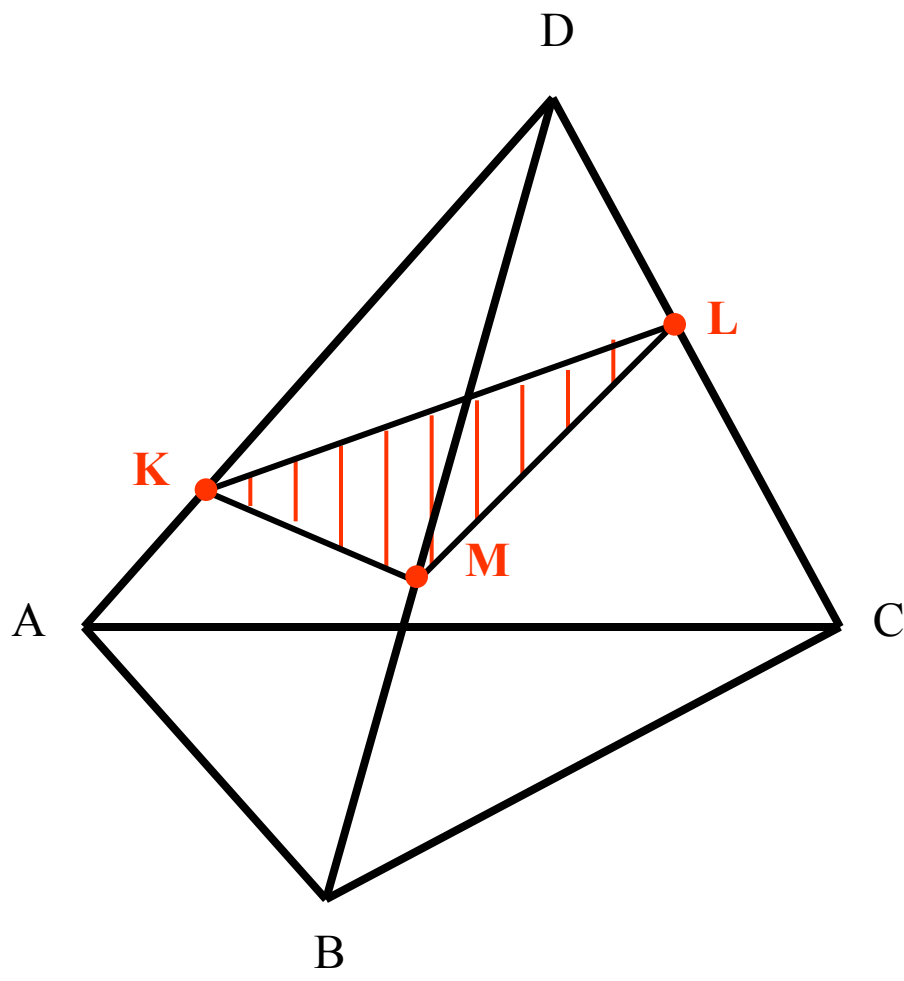

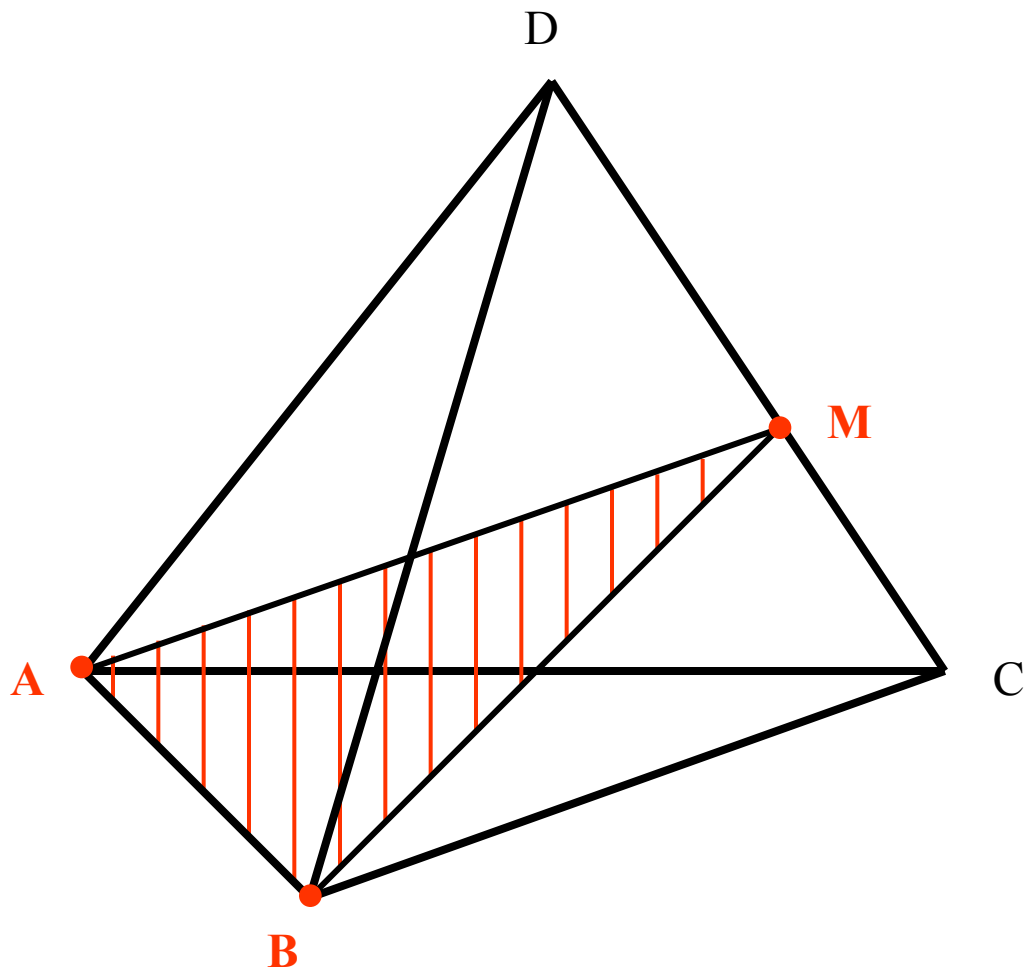

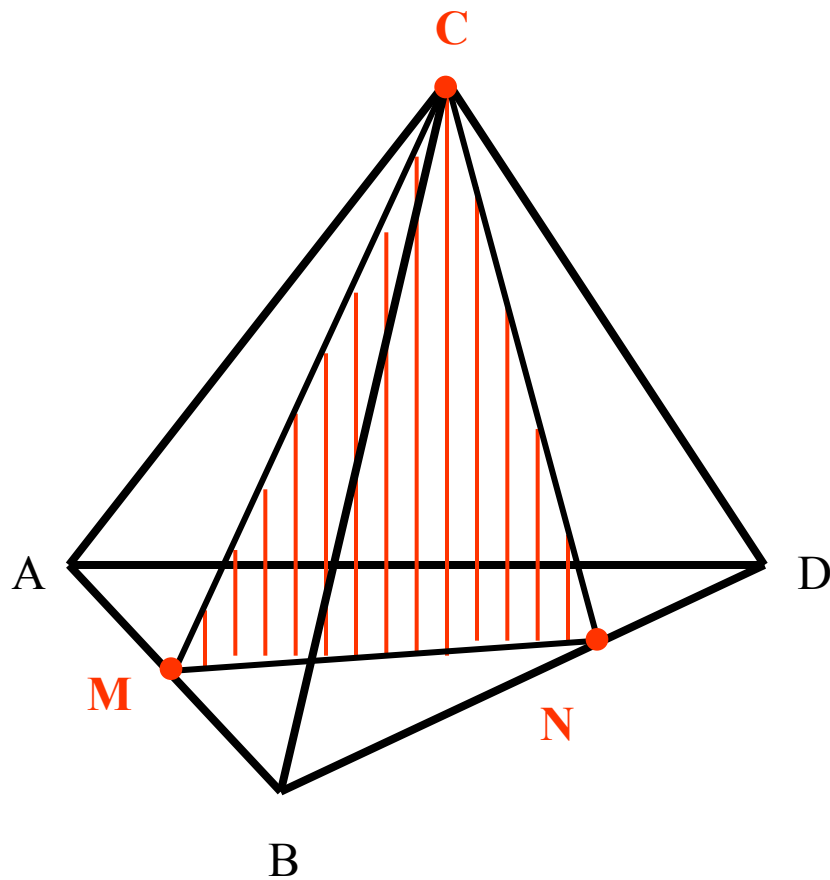

Образовательный портал "Мой университет" - [www.moi-universitet.ru](http://www.moi-universitet.ru)  
Факультет "Реформа образования" - [www.edu-reforma.ru](http://www.edu-reforma.ru)

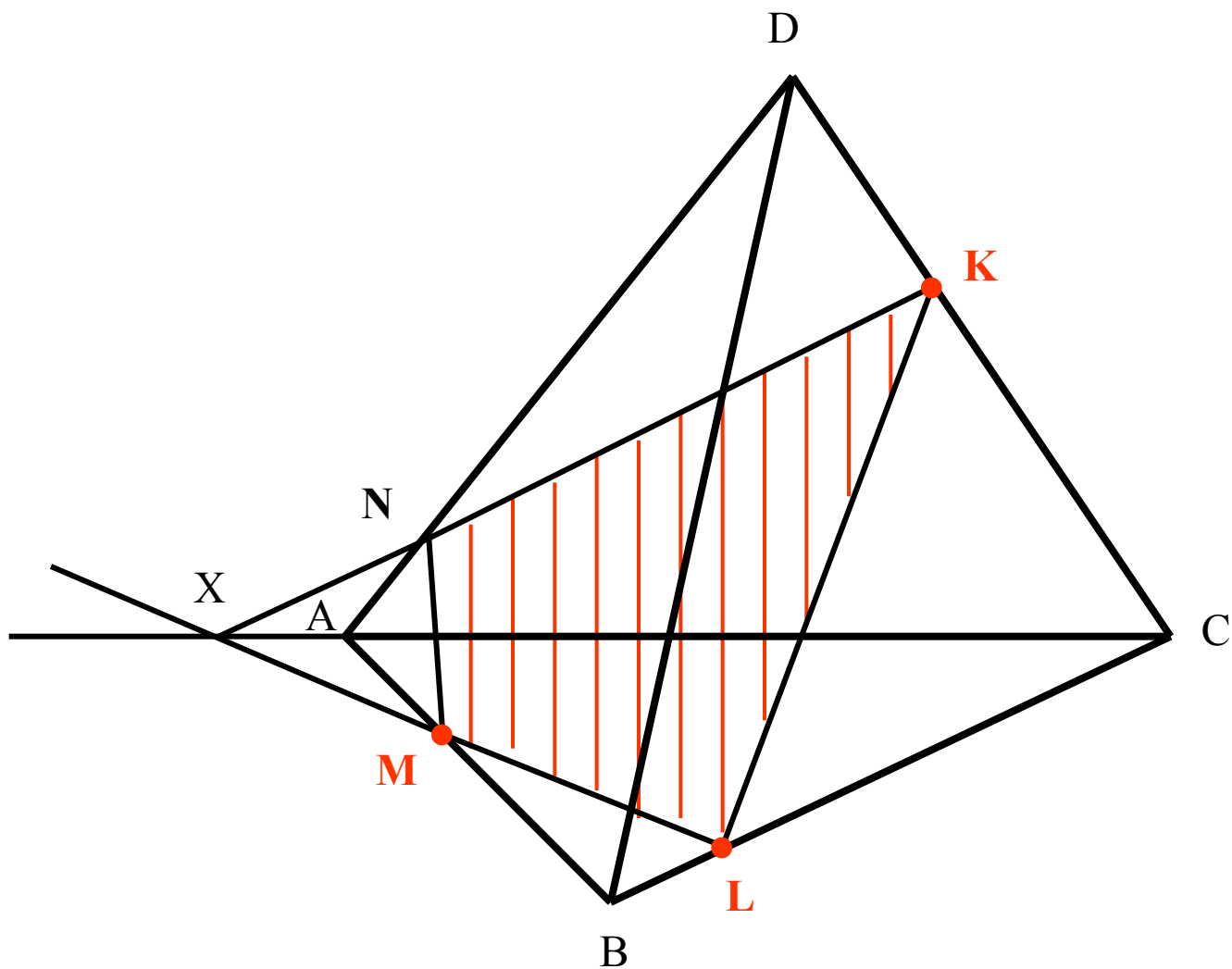

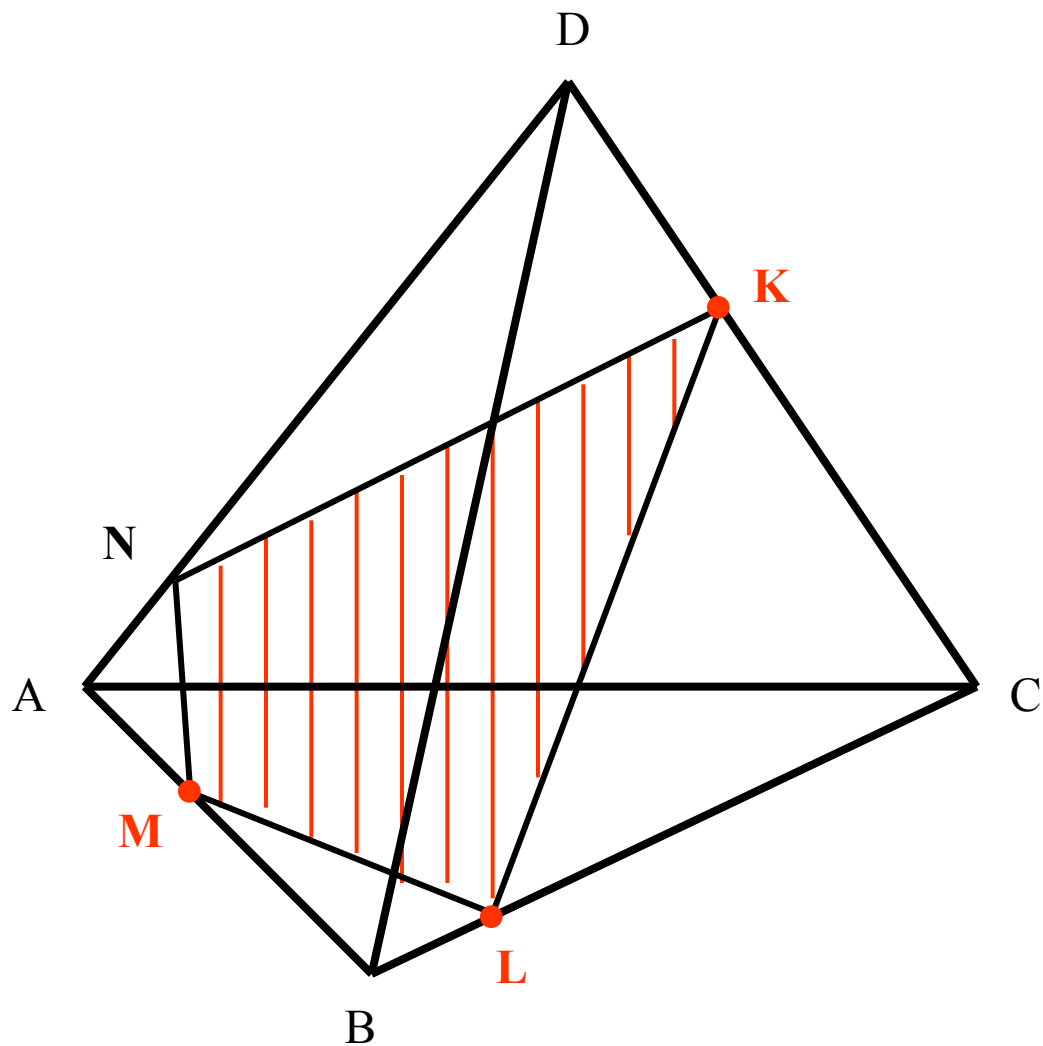

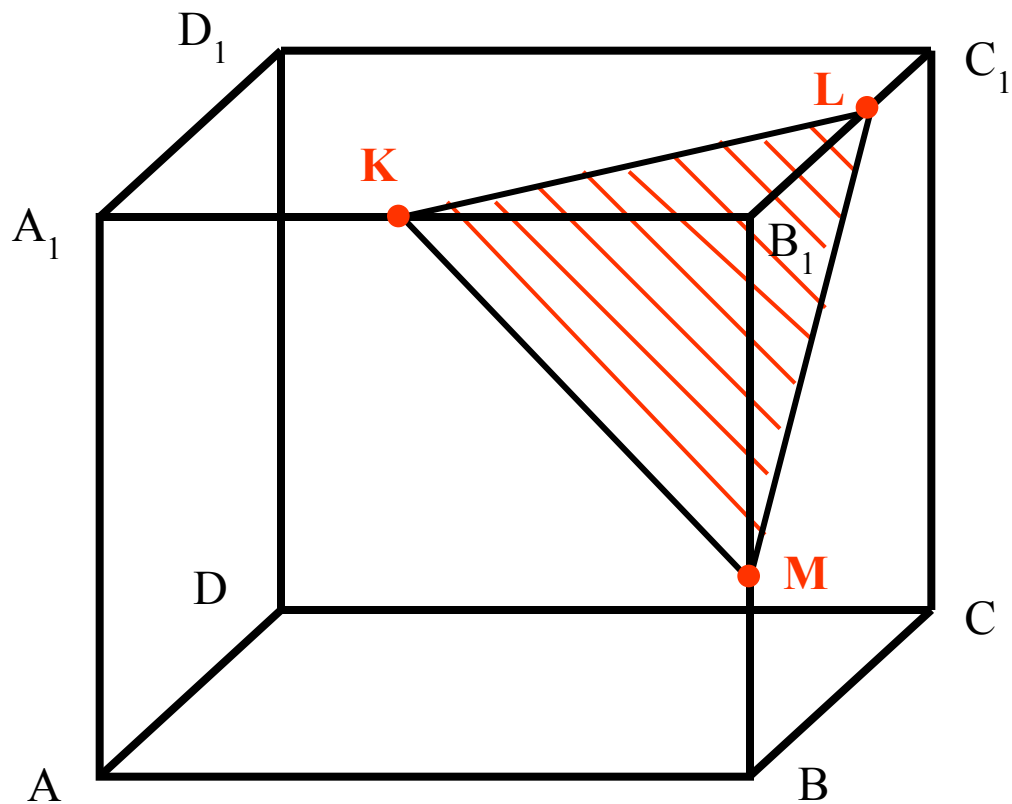

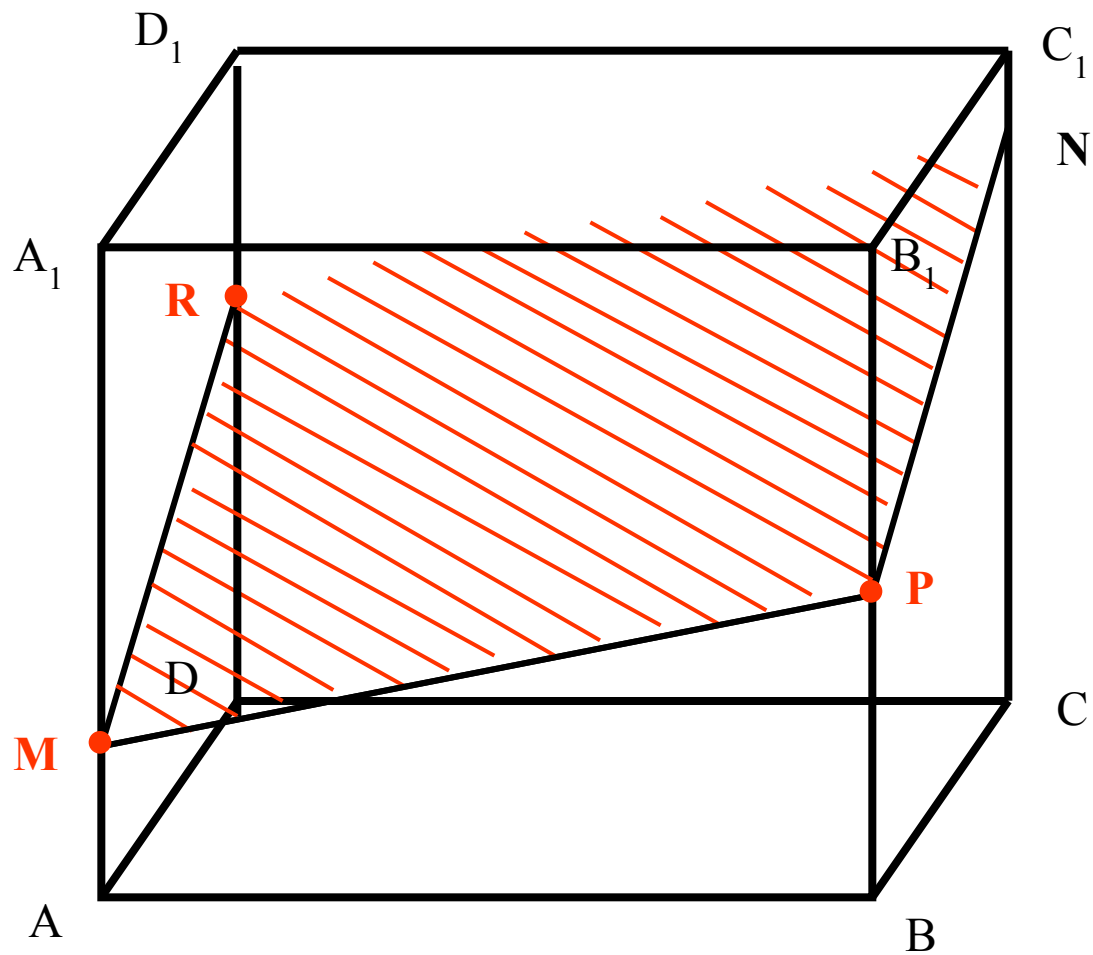



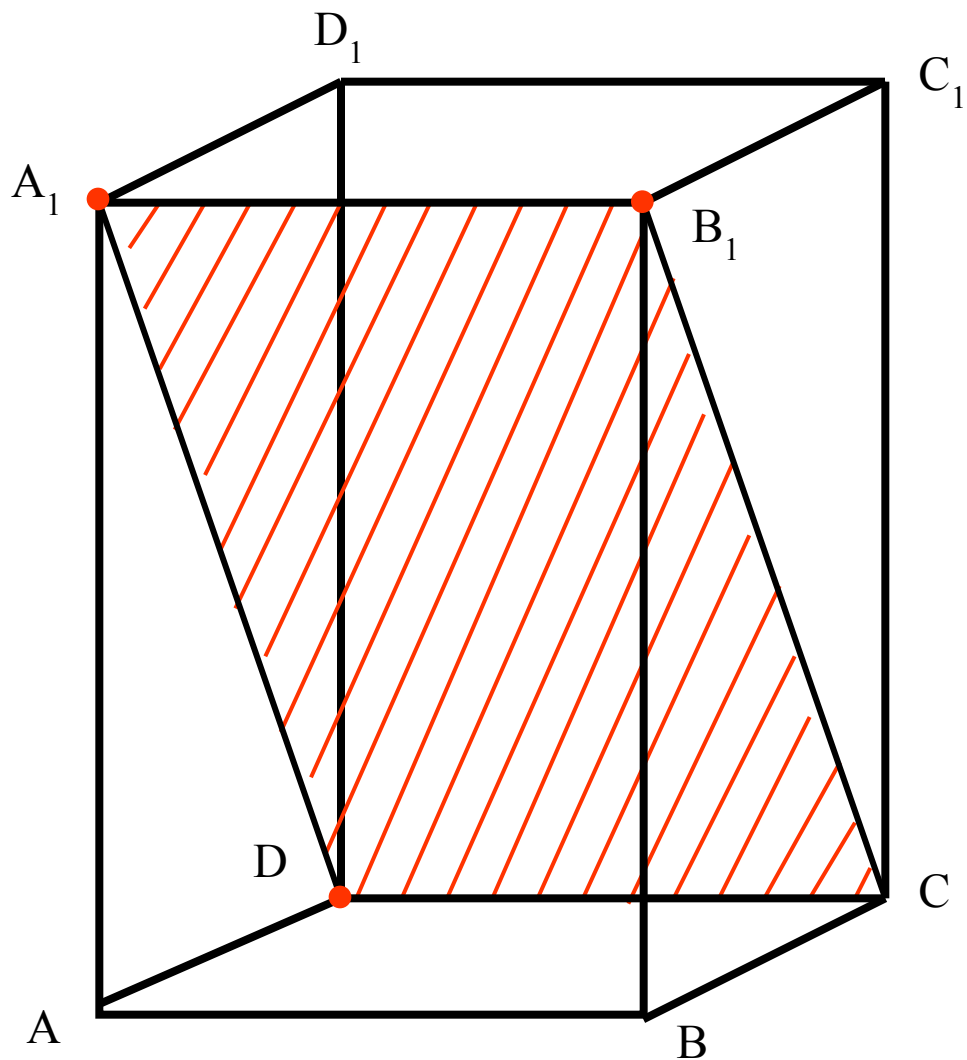

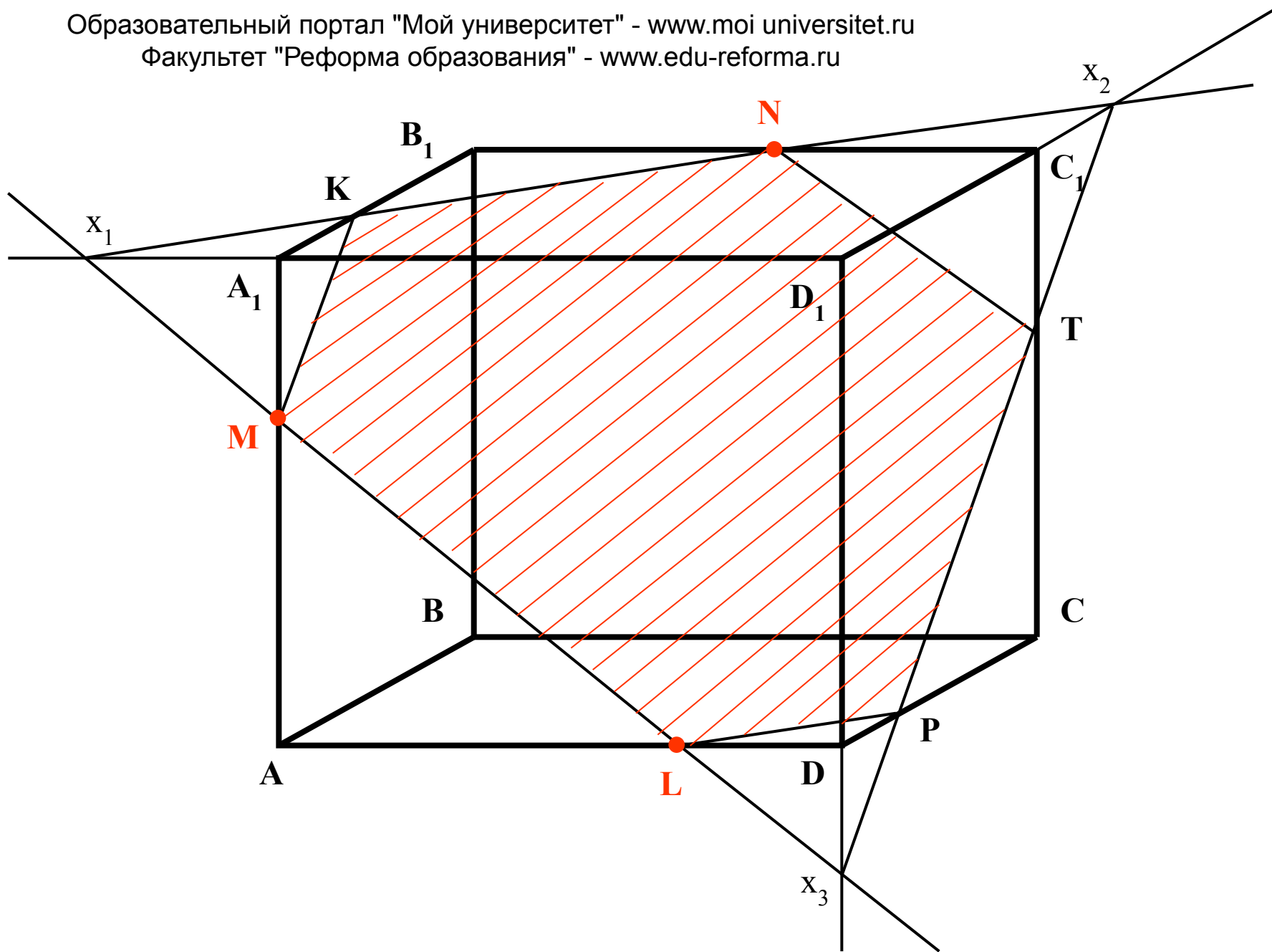

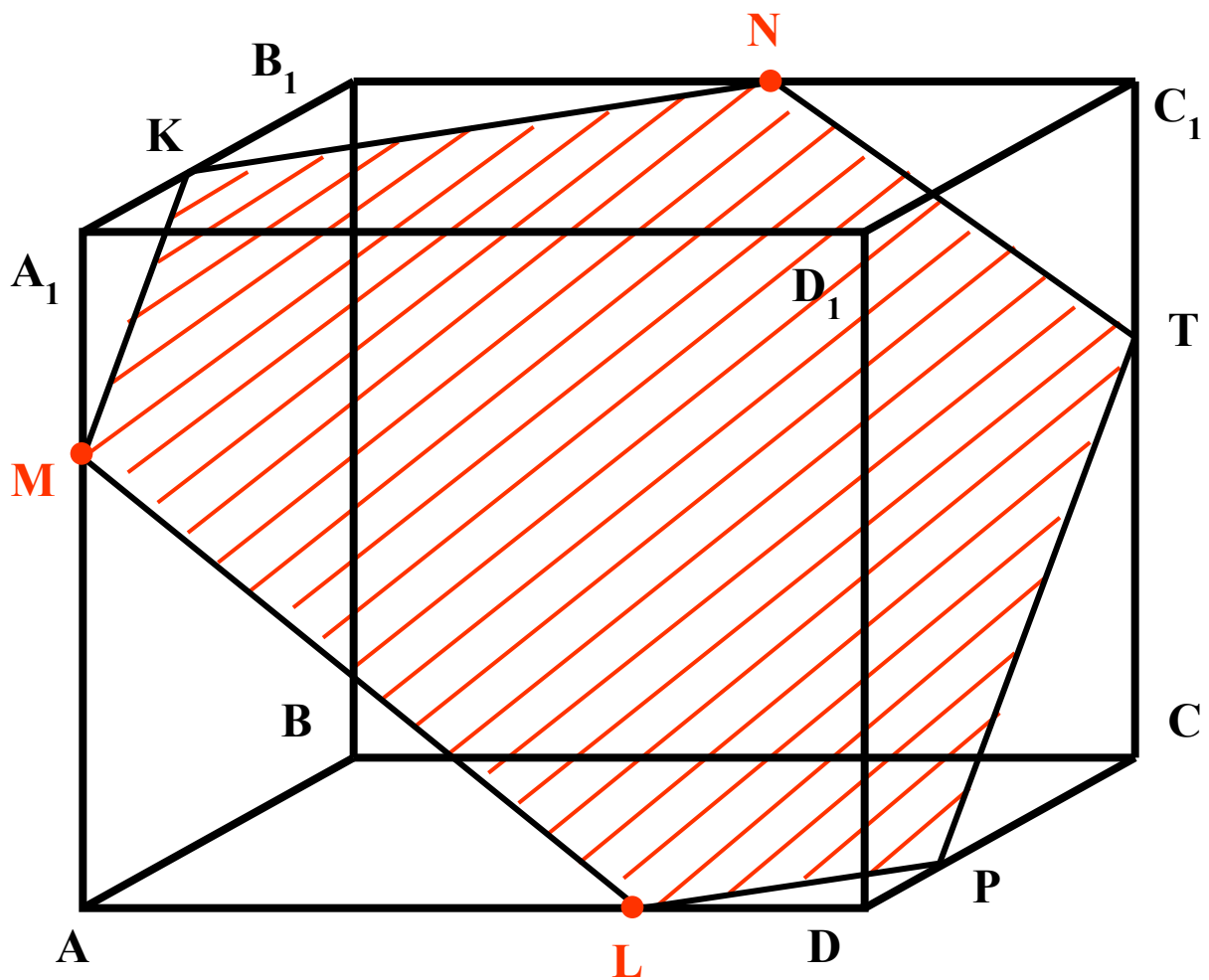

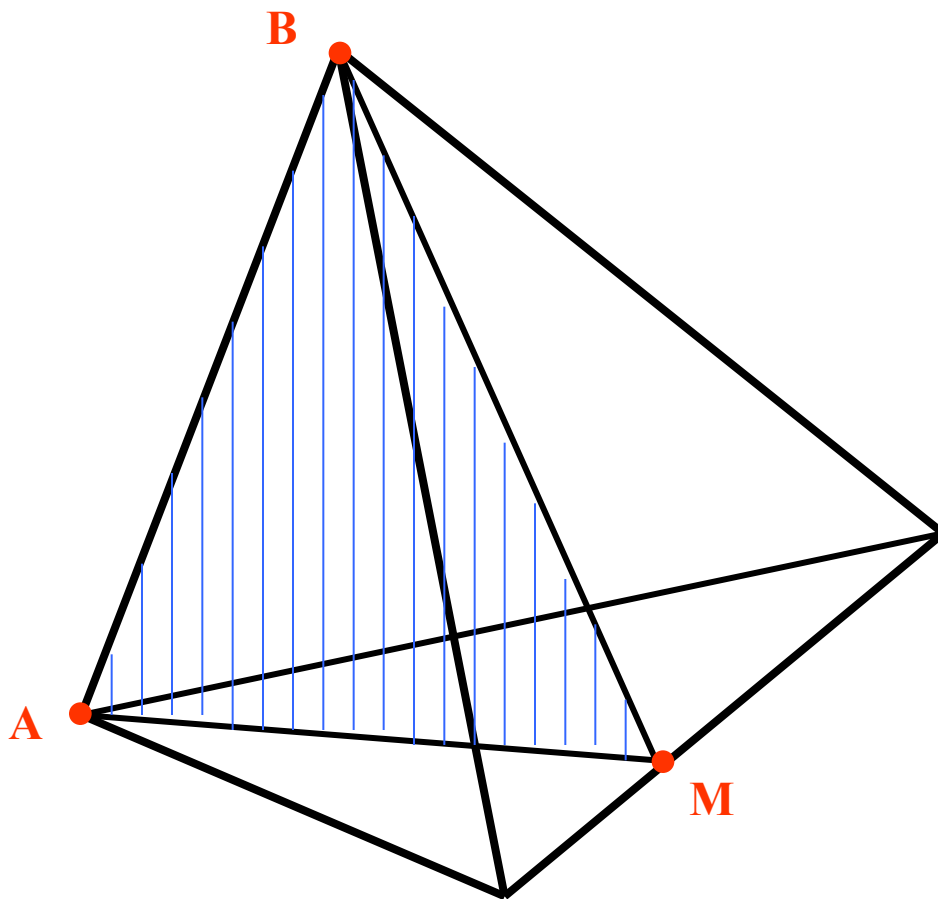

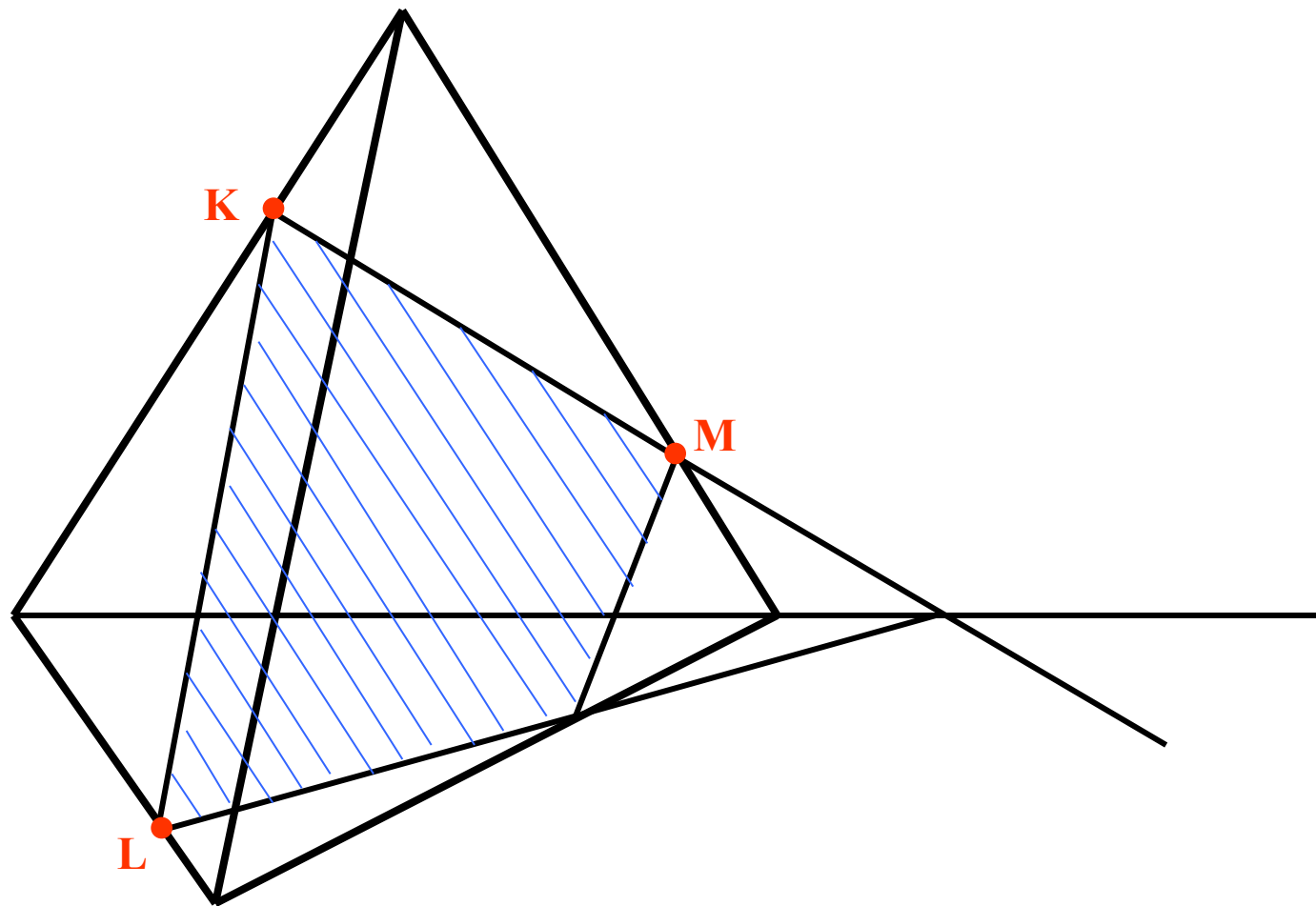

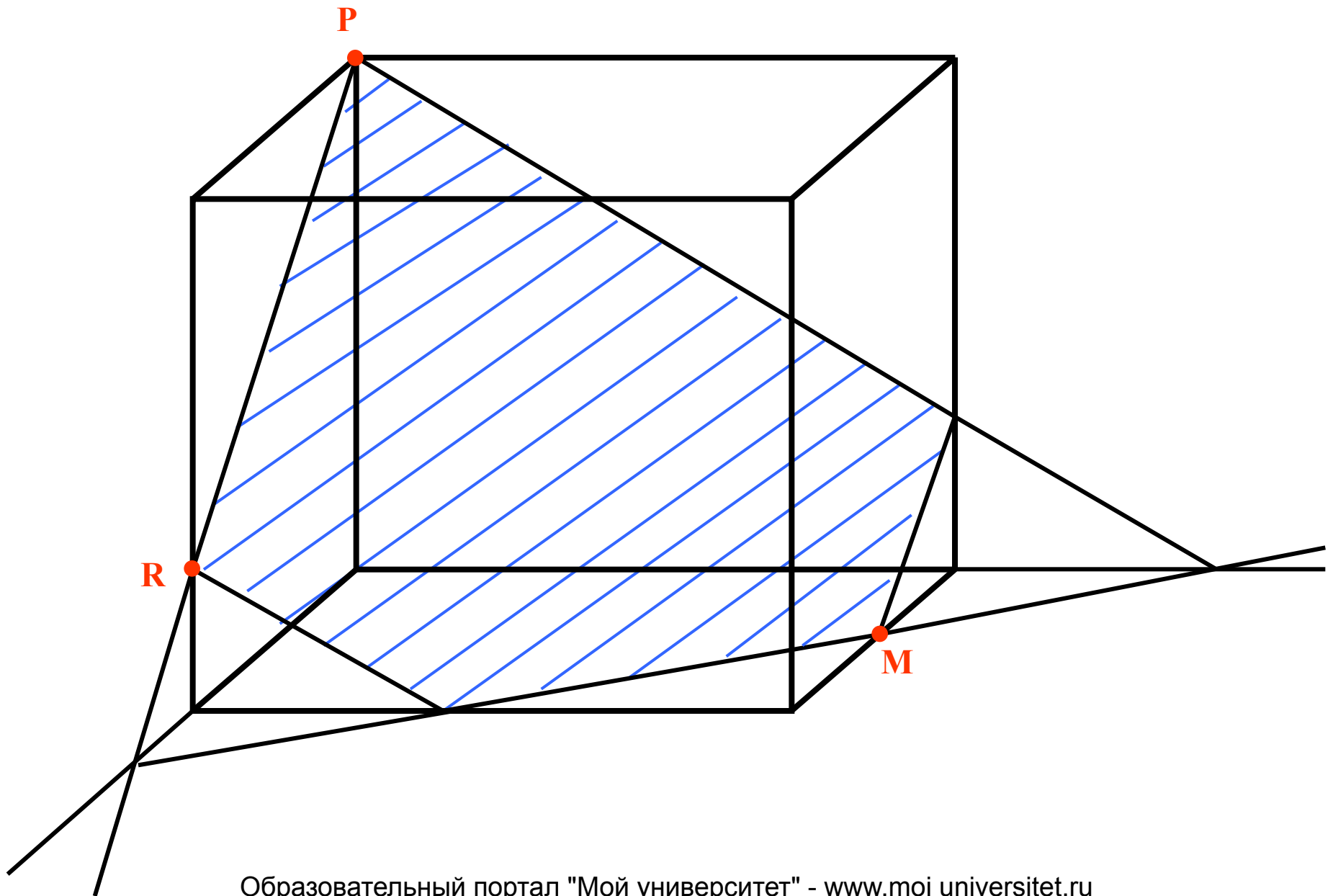

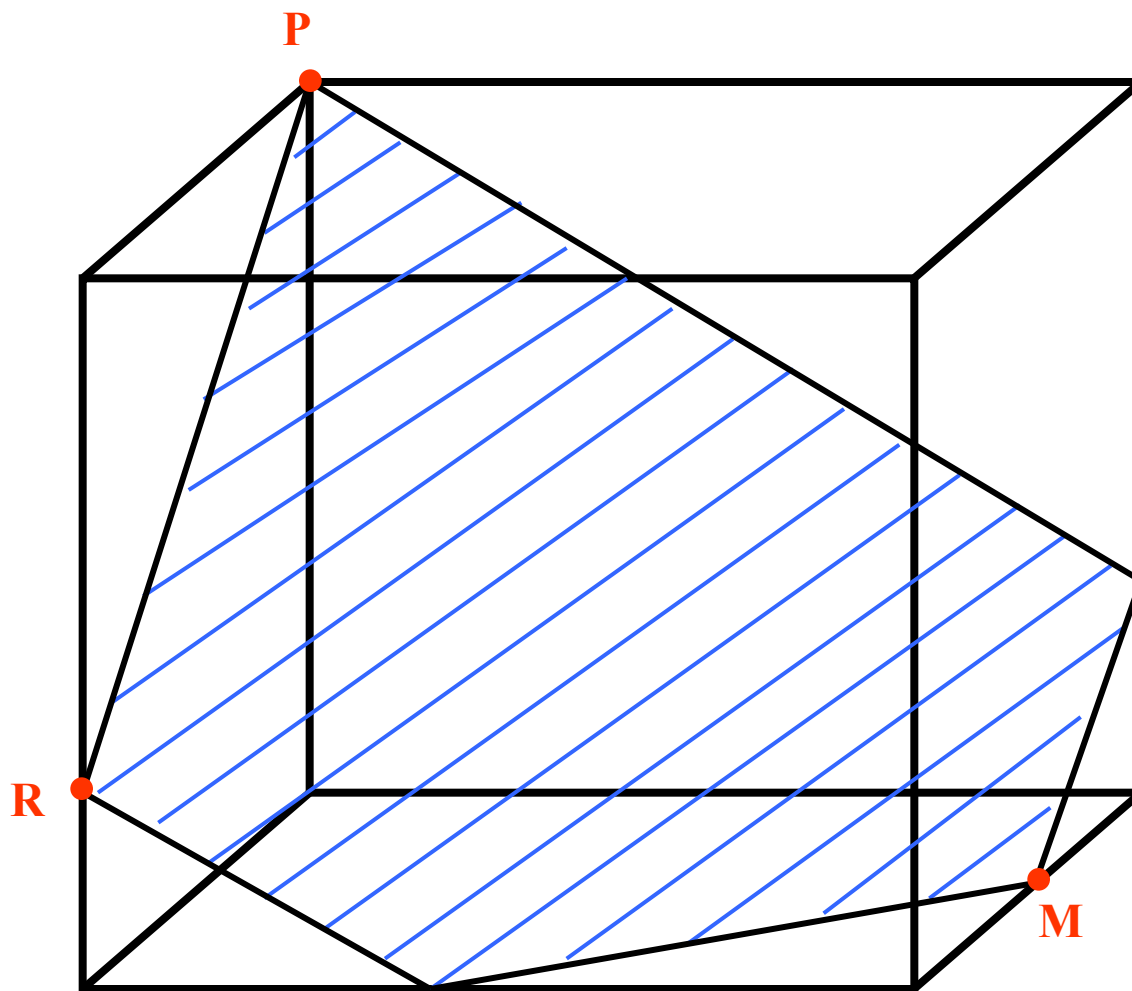

Образовательный портал "Мой университет" - [www.moi-universitet.ru](http://www.moi-universitet.ru)  
Факультет "Реформа образования" - [www.edu-reforma.ru](http://www.edu-reforma.ru)

