



Network Management Center
4760 - 4755 - 4740





	Тарификация	Конфигурация Аварийные сообщения	Топология Справочник	РТР	
4715					
4730					
4740					
4750					
NEW 4760					



Количественные характеристики

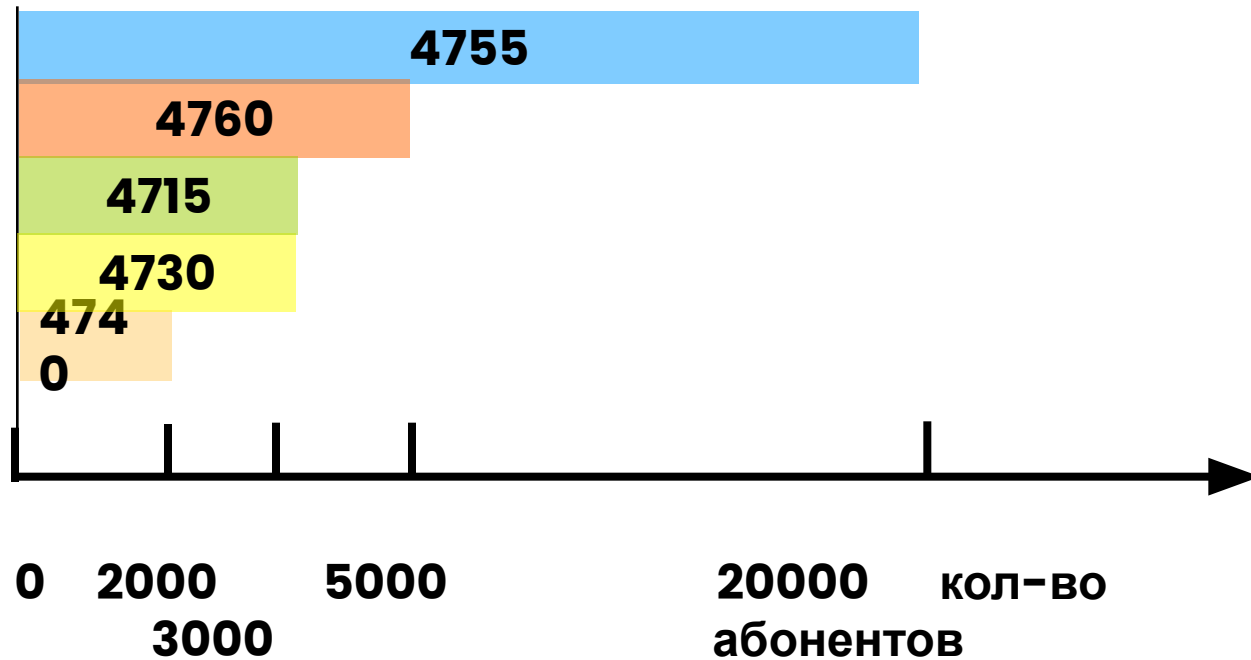



- **Ethernet**

- При отсутствии сети ПД у клиента

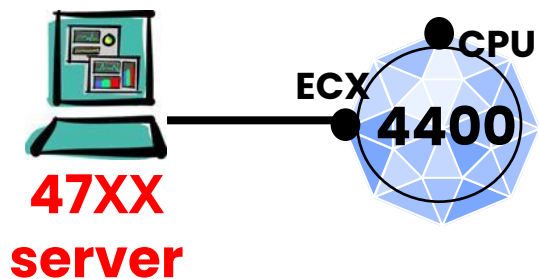

- При наличии сети

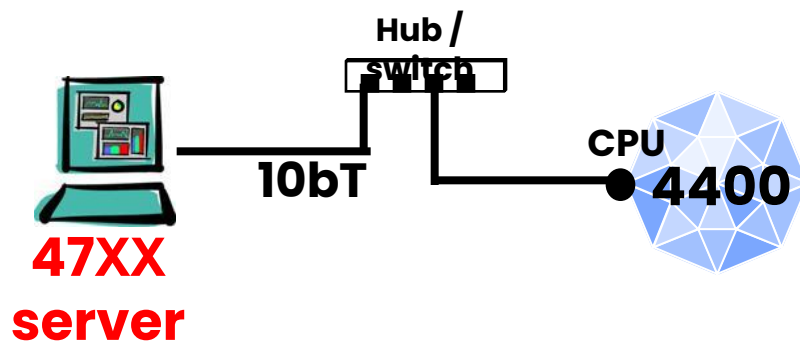



- Ethernet

- Удаленный доступ

- X25 call in B channel

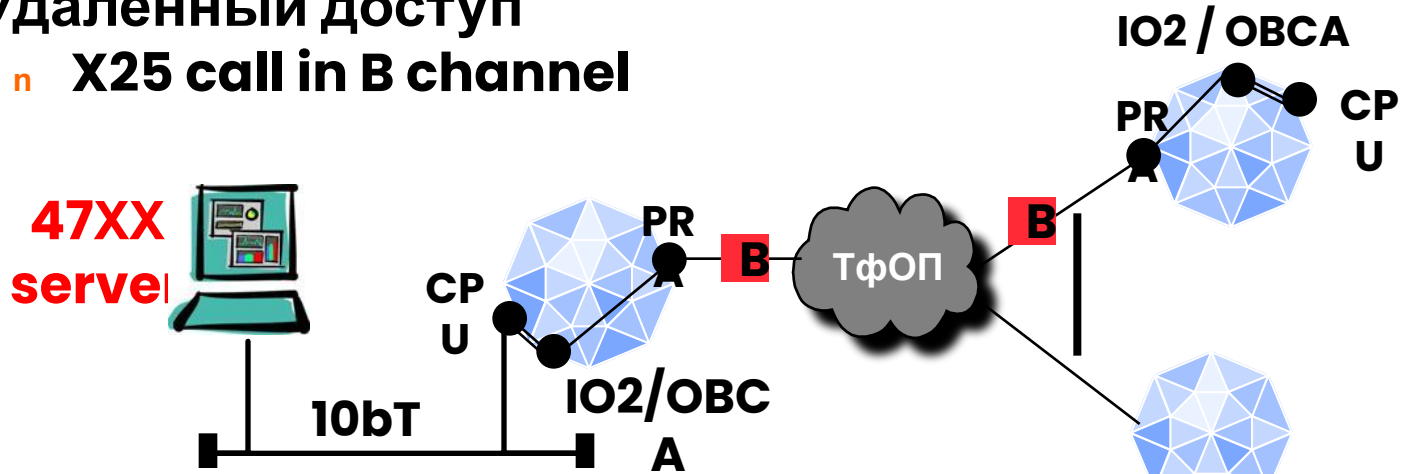

- Через маршрутизатор

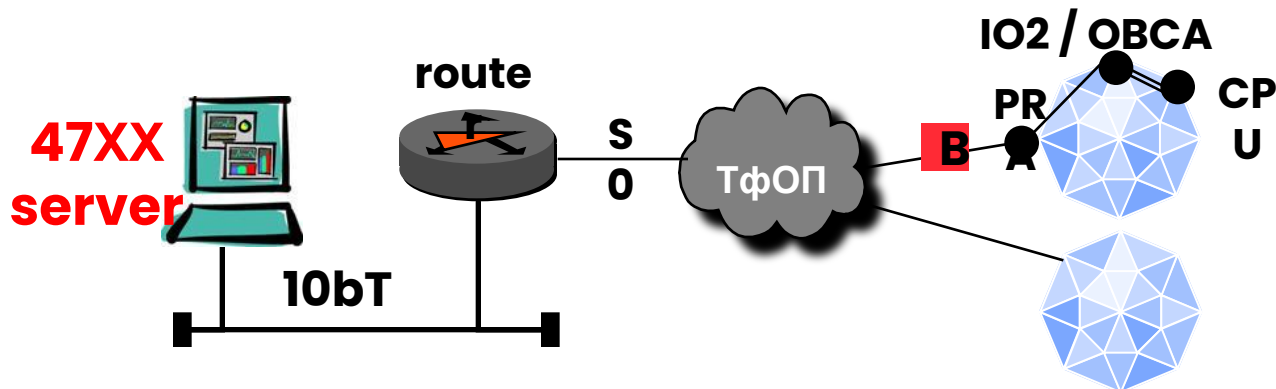



- **V24 serial line : Point to Point Protocol (4760)**
 - **Прямой доступ**

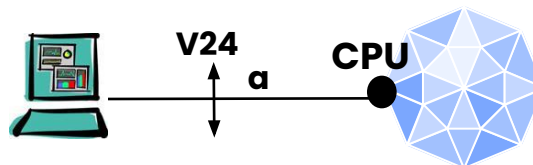

V24α : Asynchronous
V24



- **V24 serial line : Point to Point Protocol (4760)**

- **Доступ через терминальный адаптер (ТА)**

- n Решение доступно технически, но требует плат **SPB** и **IO2**.
 - n Доступ к местному узлу

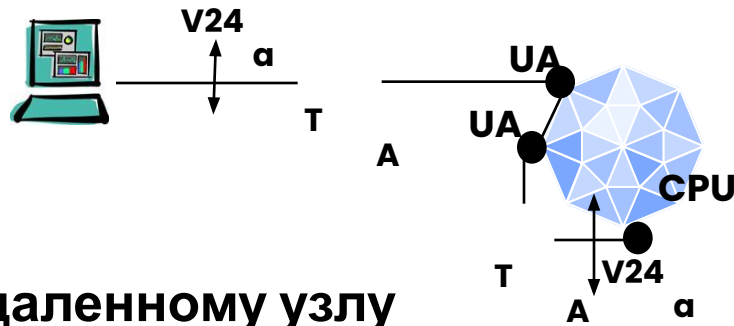

V24a : Asynchronous
V24

- n Доступ к удаленному узлу

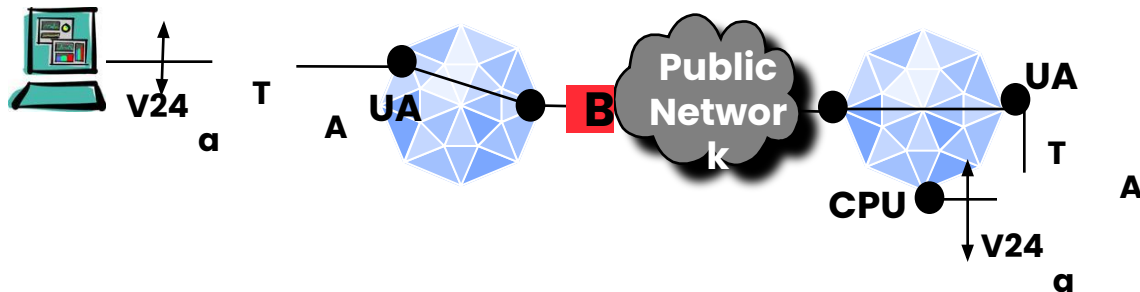



- **V24 serial line : Point to Point Protocol (4760)**

- **Доступ через TA / IO2**

- n **Доступ к местному узлу**

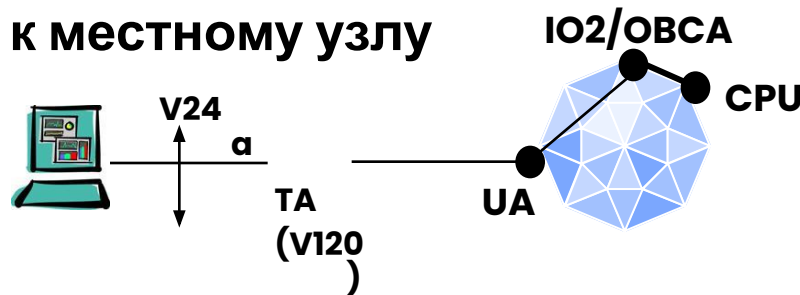

V24a : Asynchronous
V24

- n **Доступ к удаленному узлу**

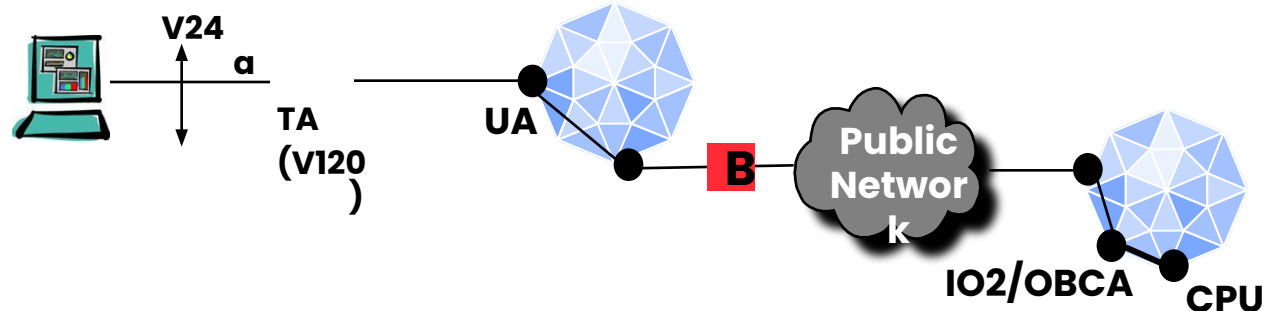



• V24 serial line : Point to Point Protocol (4760)

• Доступ через аналоговый модем

n Доступ к местному узлу



V24a : Asynchronous
V24

n Доступ к удаленному узлу

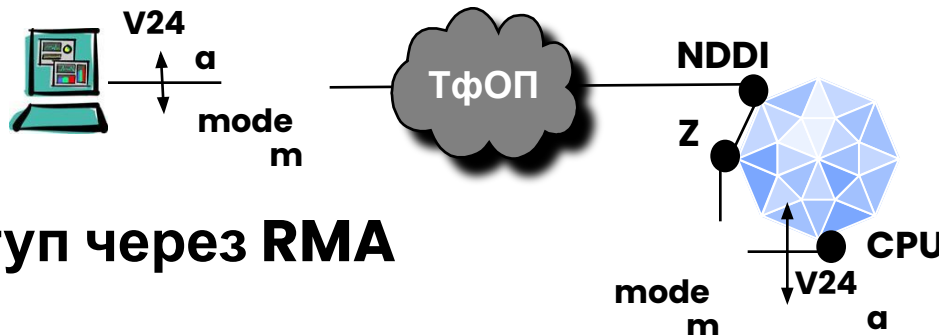

• Доступ через RMA

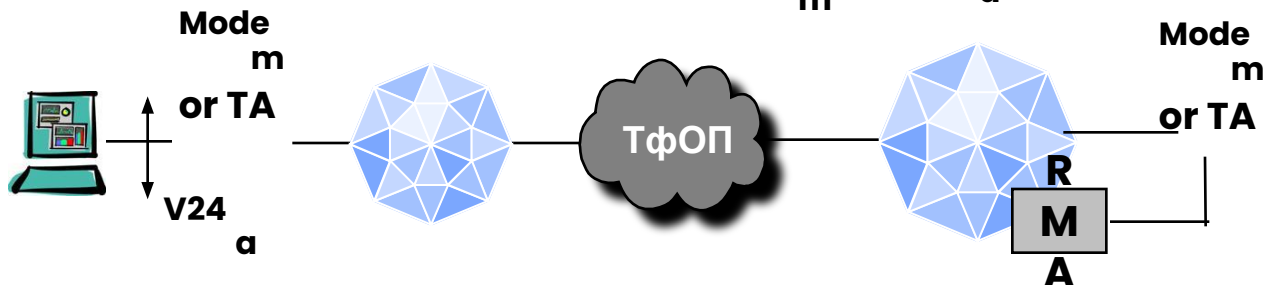



- Доступ через туннель IP/X25
 - Ethernet интерфейс

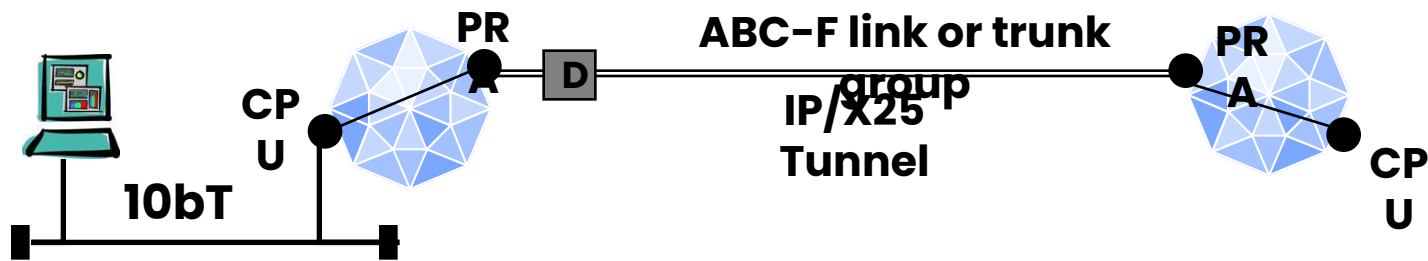

- V24 интерфейс (4760)

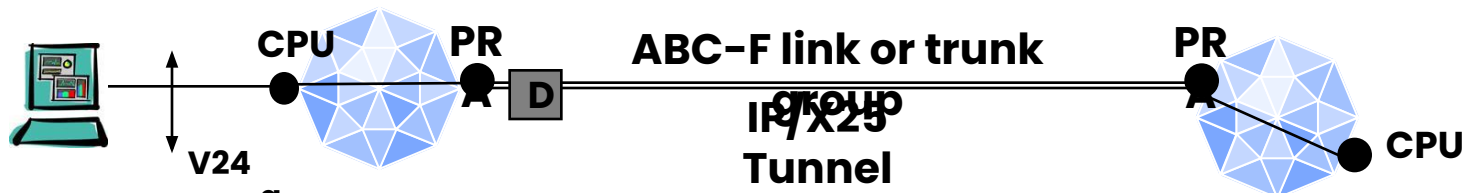

Используя Point to Point Protocol



- Доступ через туннель IP/X25
 - при наличии IO2/OVCA
 - n Используя D-канал

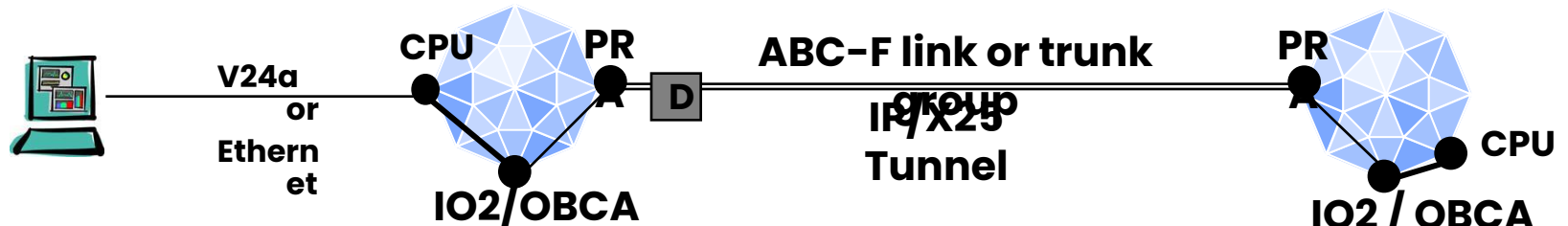

- PRA обрабатывает уровни 1 и 2; IO2 обрабатывает LAPD и выделяет "сигнализацию X25", посылаемую CPU

- n Используя B-канал

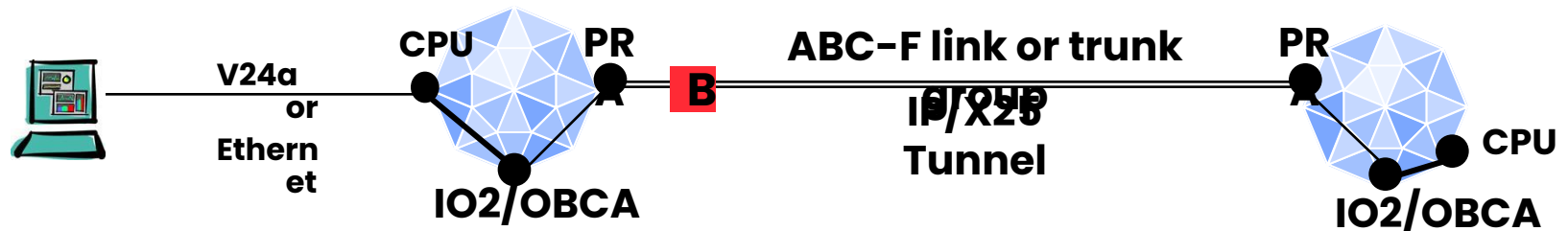



- Доступ через туннель IP/X25
 - При наличии IO2/OVCA
 - Используя В-канал с транзитом X25

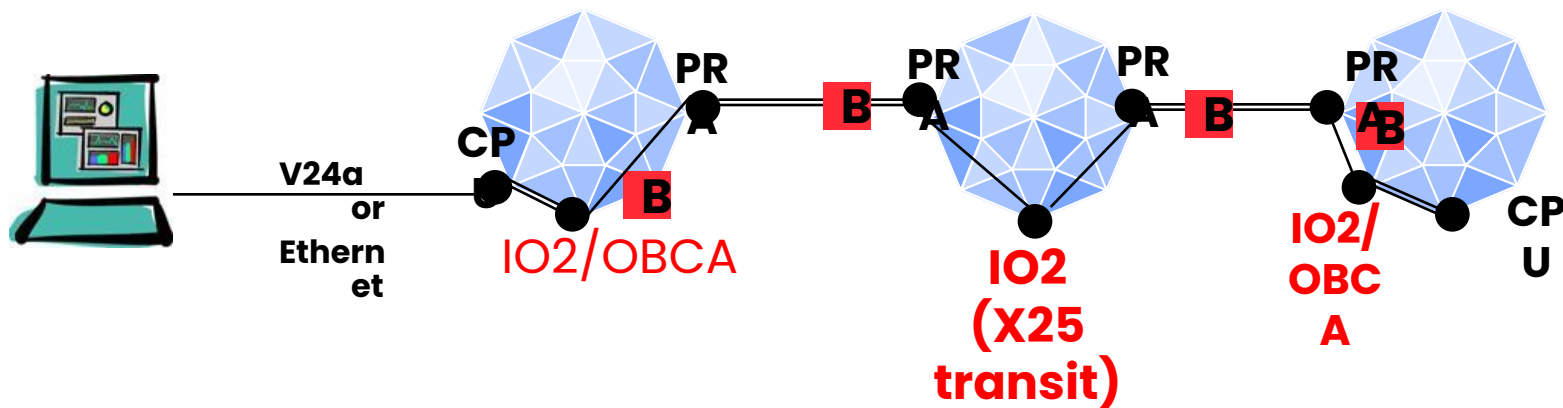



- Уведомления об авариях – вывод в реальном времени

- Список аварий информации

- уровень,
- объект,
- дата,
- тип,
- причина,
- дополнит. информация
- диагностика

C

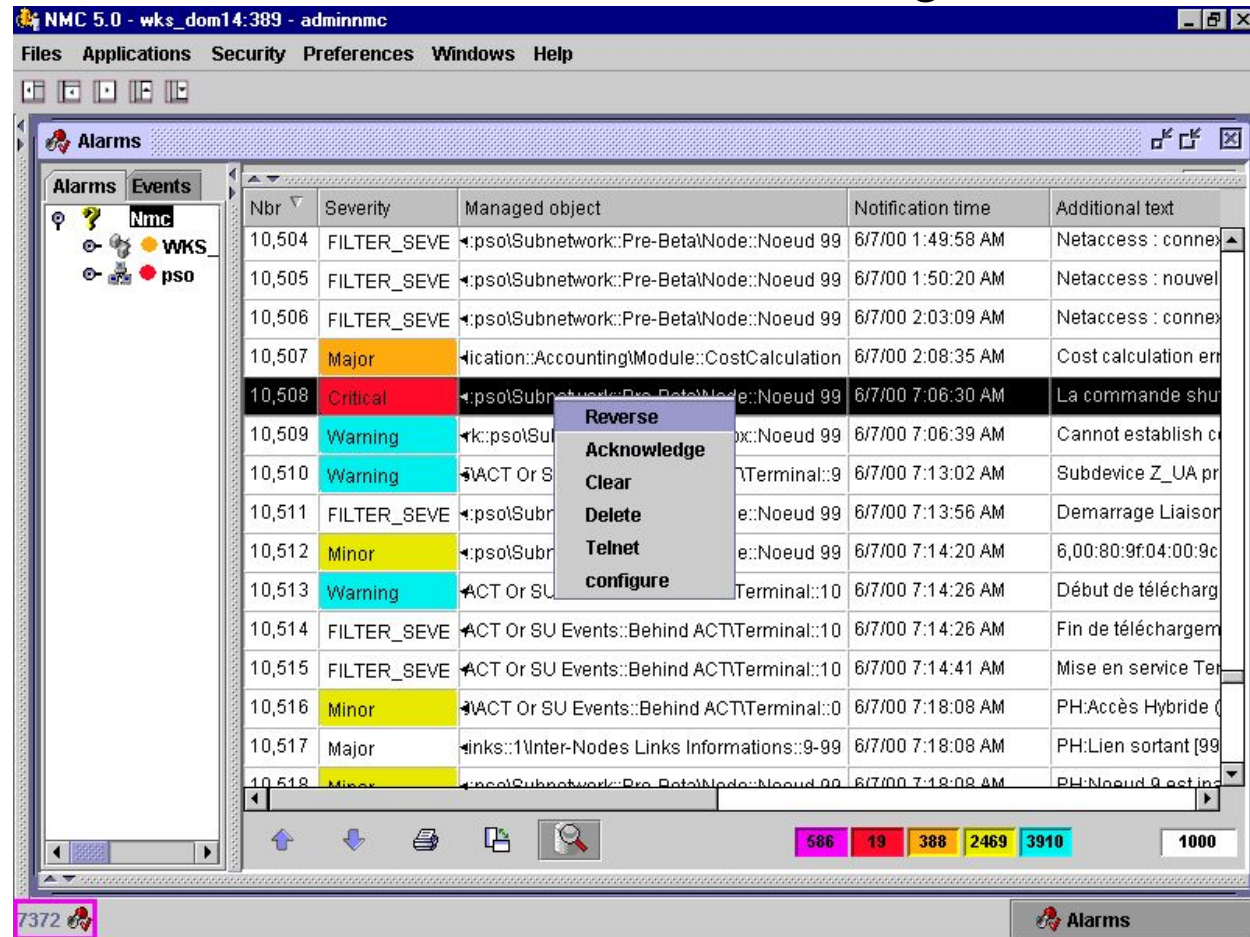

NMC 5.0 - wks_dom14:389 - adminmc

Files Applications Security Preferences Windows Help

Alarms

Nbr	Severity	Managed object	Notification time	Additional text
10,504	FILTER_SEVE	psolSubnetwork::Pre-BetaNode::Noeud 99	6/7/00 1:49:58 AM	Netaccess : connexion
10,505	FILTER_SEVE	psolSubnetwork::Pre-BetaNode::Noeud 99	6/7/00 1:50:20 AM	Netaccess : nouvelle
10,506	FILTER_SEVE	psolSubnetwork::Pre-BetaNode::Noeud 99	6/7/00 2:03:09 AM	Netaccess : connexion
10,507	Major	ication::AccountingModule::CostCalculation	6/7/00 2:08:35 AM	Cost calculation error
10,508	Critical	psolSubnetwork::Pre-BetaNode::Noeud 99	6/7/00 7:06:30 AM	La commande shutdown
10,509	Warning	psolSubnetwork::Pre-BetaNode::Noeud 99	6/7/00 7:06:39 AM	Cannot establish connection
10,510	Warning	ACT Or SU Events::Behind ACTTerminal::9	6/7/00 7:13:02 AM	Subdevice_Z_UA processing
10,511	FILTER_SEVE	psolSubnetwork::Pre-BetaNode::Noeud 99	6/7/00 7:13:56 AM	Demarrage Liaison
10,512	Minor	psolSubnetwork::Pre-BetaNode::Noeud 99	6/7/00 7:14:20 AM	6,00:80:9f:04:00:9c
10,513	Warning	ACT Or SU Events::Behind ACTTerminal::10	6/7/00 7:14:26 AM	Début de téléchargement
10,514	FILTER_SEVE	ACT Or SU Events::Behind ACTTerminal::10	6/7/00 7:14:26 AM	Fin de téléchargement
10,515	FILTER_SEVE	ACT Or SU Events::Behind ACTTerminal::10	6/7/00 7:14:41 AM	Mise en service Terminal
10,516	Minor	ACT Or SU Events::Behind ACTTerminal::0	6/7/00 7:18:08 AM	PH:Accès Hybride (99)
10,517	Major	links::1Inter-Nodes Links Informations::9-99	6/7/00 7:18:08 AM	PH:Lien sortant (99)
10,518	Minor	psolSubnetwork::Pre-BetaNode::Noeud 99	6/7/00 7:18:08 AM	PH:Noeud 9 est indisponible

Reverse
Acknowledge
Clear
Delete
Telnet
configure

586 19 388 2469 3910 1000

7372 Alarms



- Уведомления об авариях – вывод в реальном времени

- На топологических видах

- Авто-раскрытие

- Анимация топологии используя

аварии

- Прямой из топологии к конфигурации

ТОПОЛОГИИ

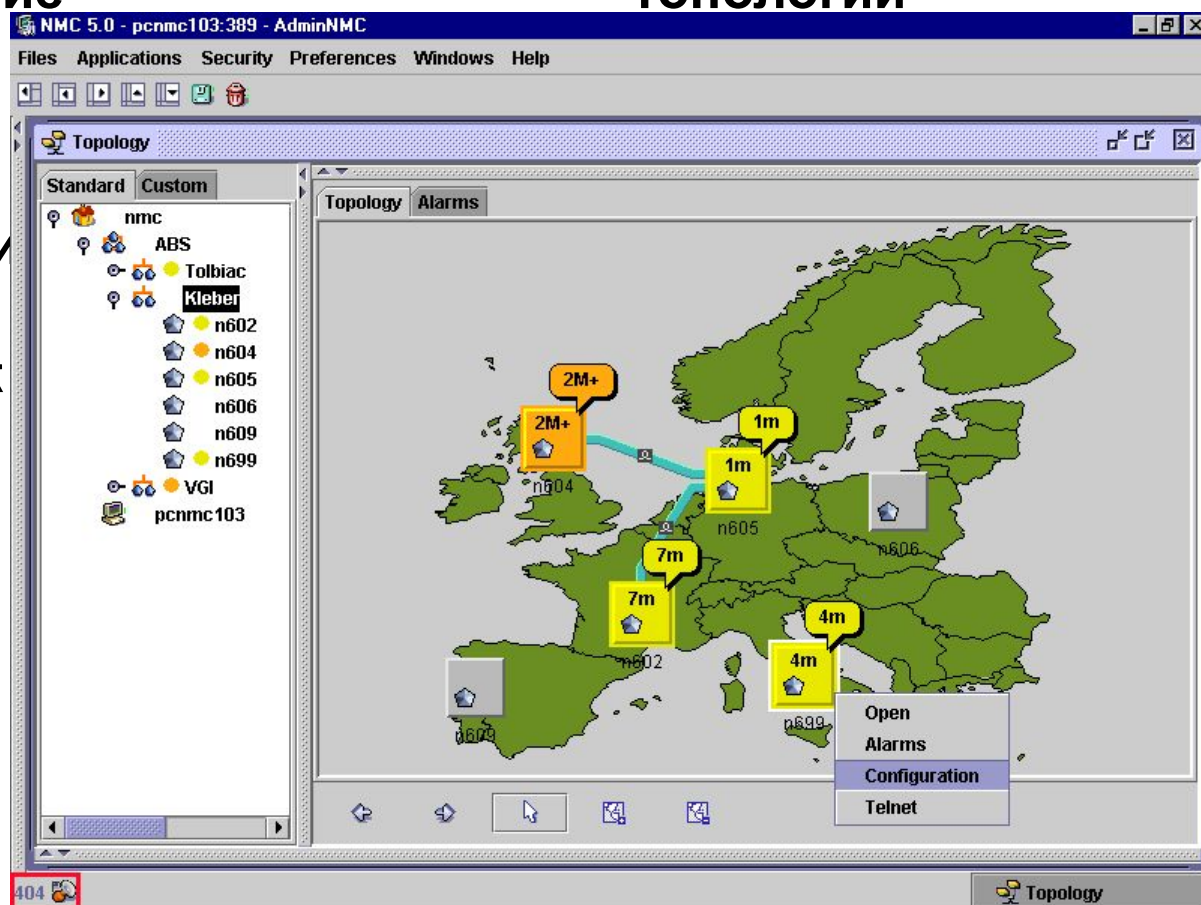

The screenshot shows the AdminNMC 5.0 interface. The main window displays a network topology map of Europe. The map includes several nodes labeled with IDs like n602, n604, n605, n606, n609, n699, and n679. Some nodes have callouts indicating status or metrics, such as '2M+', '1m', '7m', and '4m'. A context menu is open over one of the nodes, showing options: 'Open', 'Alarms', 'Configuration', and 'Telnet'. The left sidebar shows a tree view of the network structure, including 'nmc', 'ABS', 'Tolbiac', 'Kleber', and various node IDs. The top menu bar includes 'Files', 'Applications', 'Security', 'Preferences', 'Windows', and 'Help'.



Общий вид

(5 Web клиент справочника)



47XX Справочник

(1) Синхронизация 4400 / 47XX (Ручная)

47XX management client



Изменение справочника



Изменение справочника

Автоматическое изменение справочника

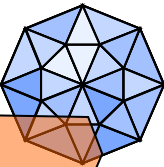

(СС, имя, фамилия)

(3) Аппарат, профиль, ... создание или изменение (ручное или автоматическое)

(2) создание справочника предприятия административные данные + СС

Изменение справочника (СС, фамилия, имя)

(4) Синхронизация сервер/сервер

Другой сервер - справочник

