

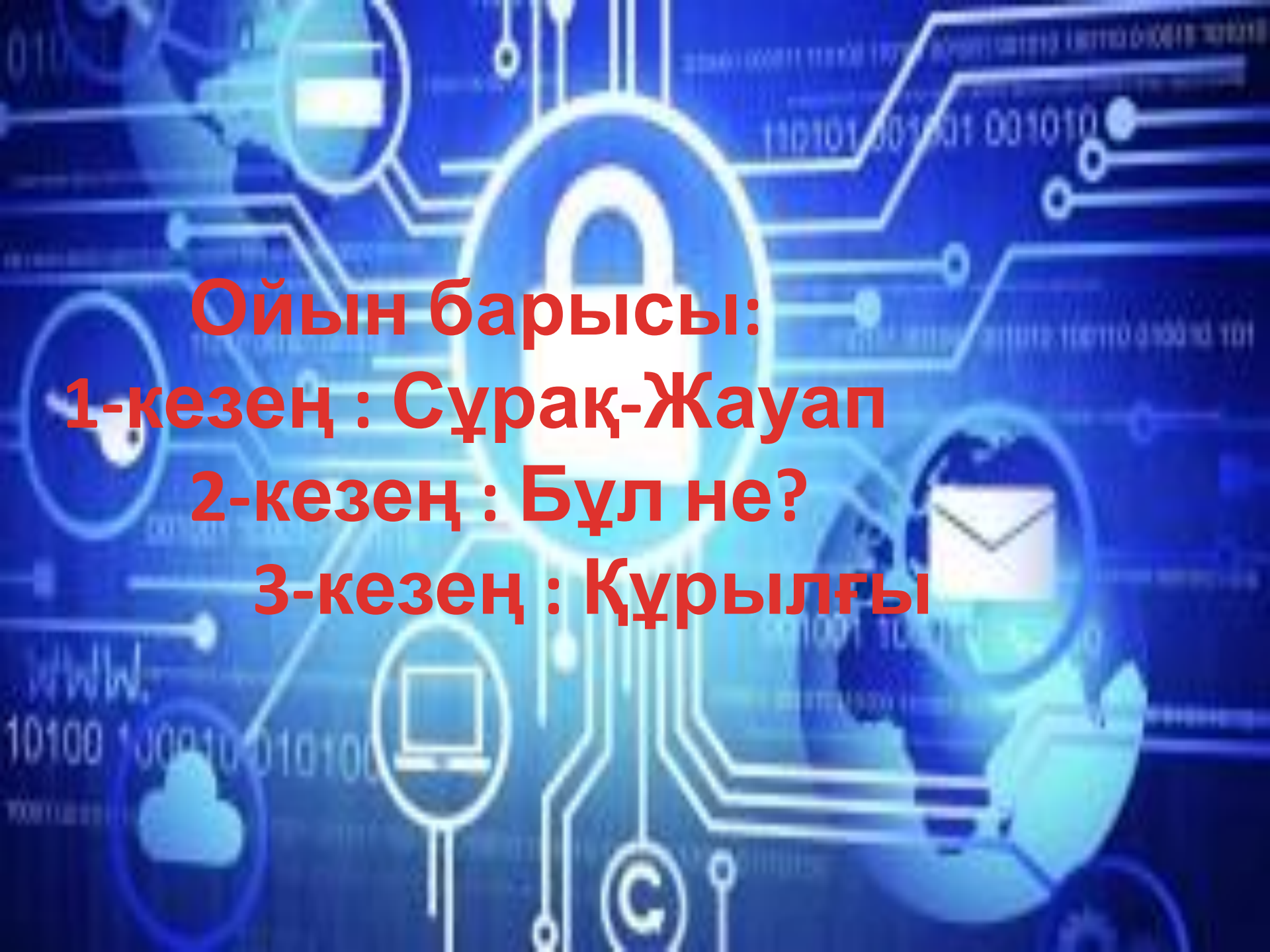

Байланыс негіздері



Ойын барысы:
1-кезең : Сұрақ-Жауап
2-кезең : Бұл не?
3-кезең : Құрылғы

2-кезең : Сұрақ-Жауа



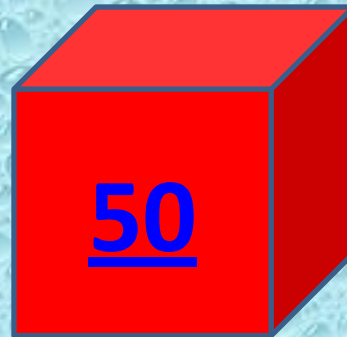
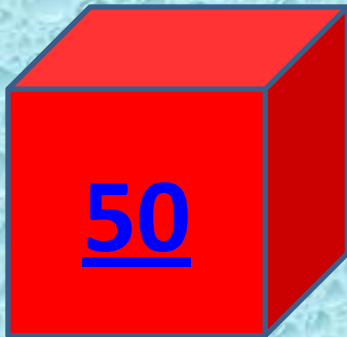
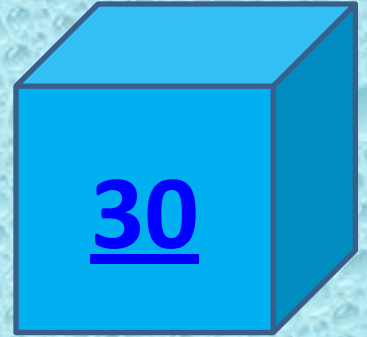
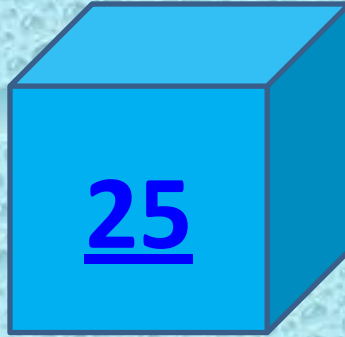
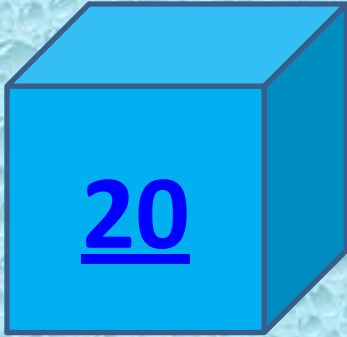
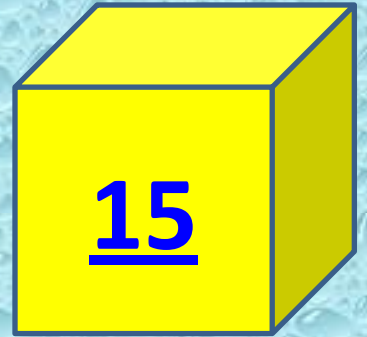
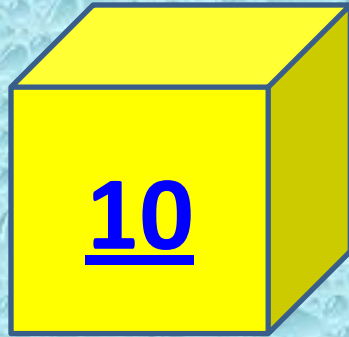
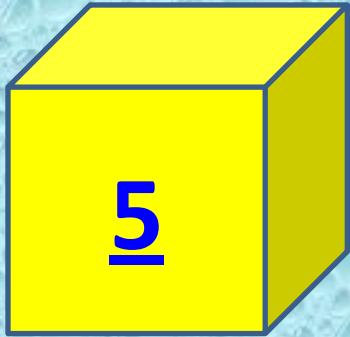

3-кезең : Бұл не?



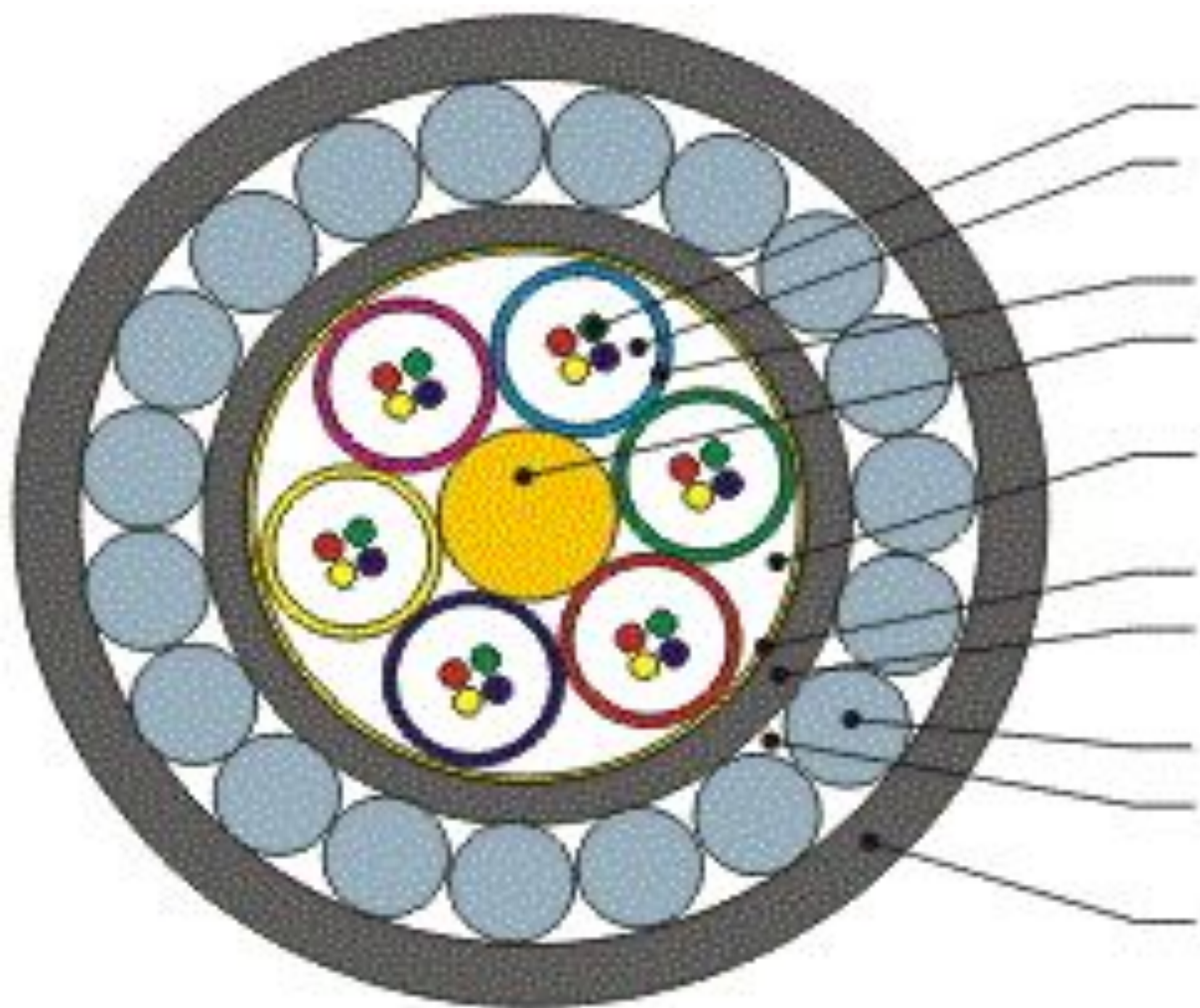

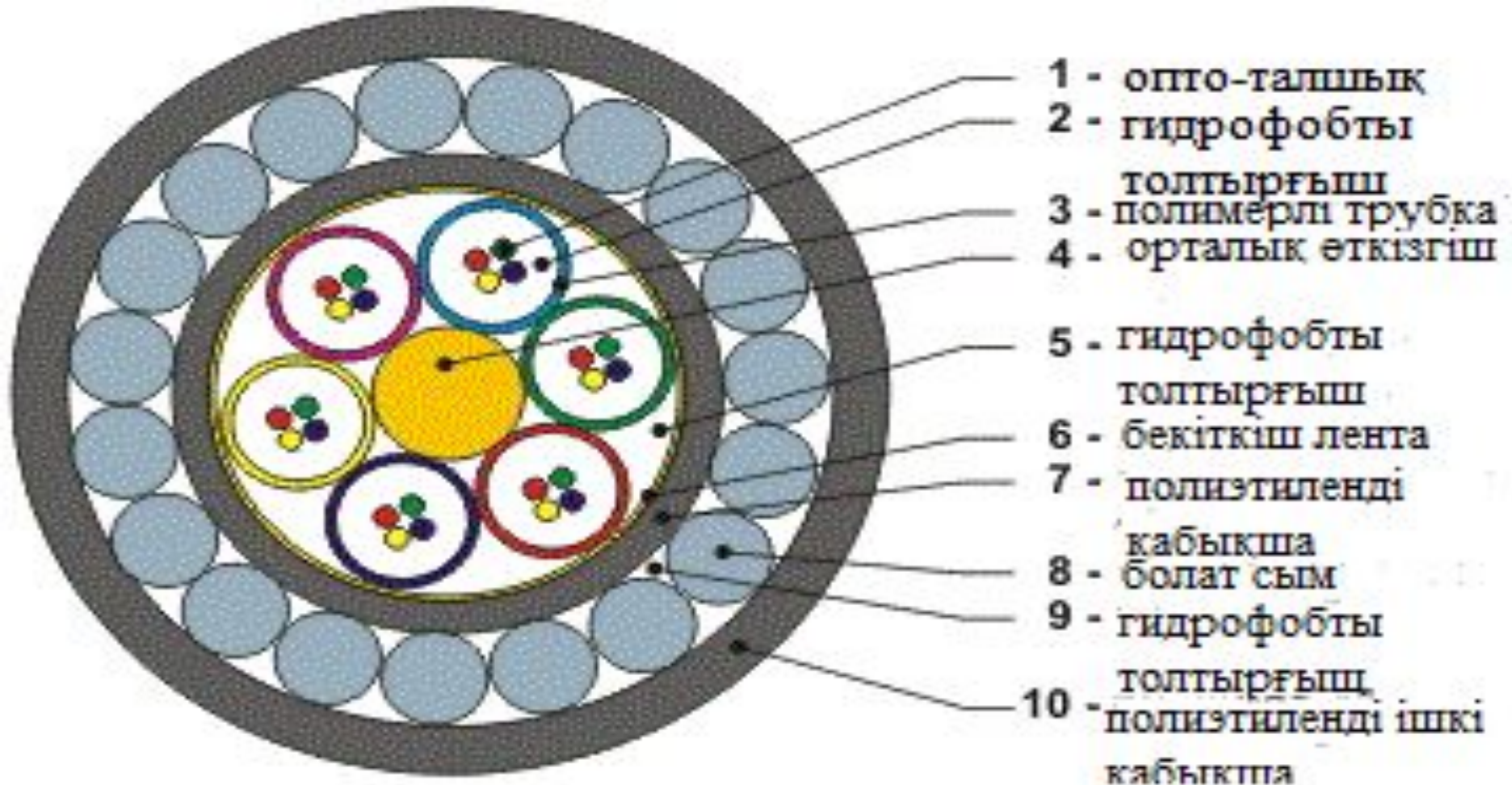

ОПТО-ТАЛШЫҚТЫ КАБЕЛЬ

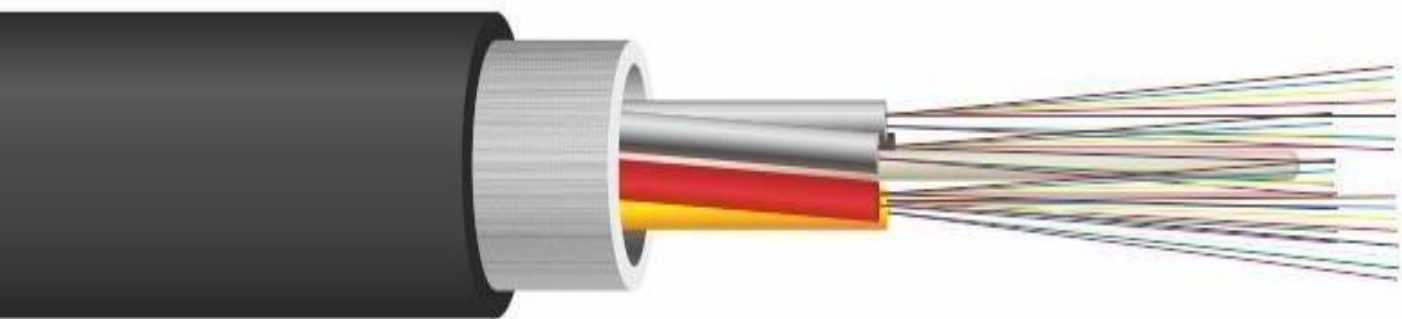



LED-OBZOR.ru



Жарықты-диодты кабель

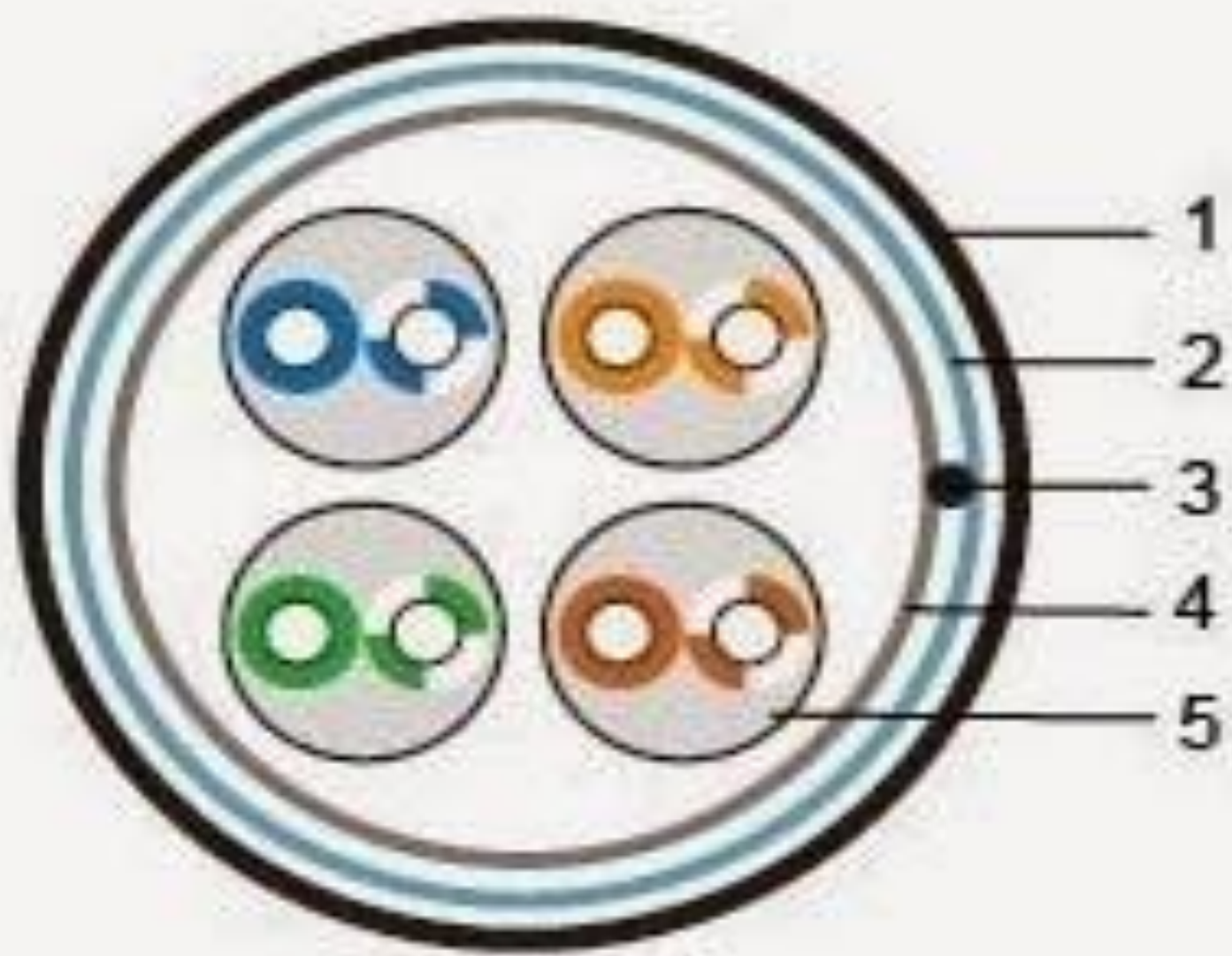

Бұралған жұп

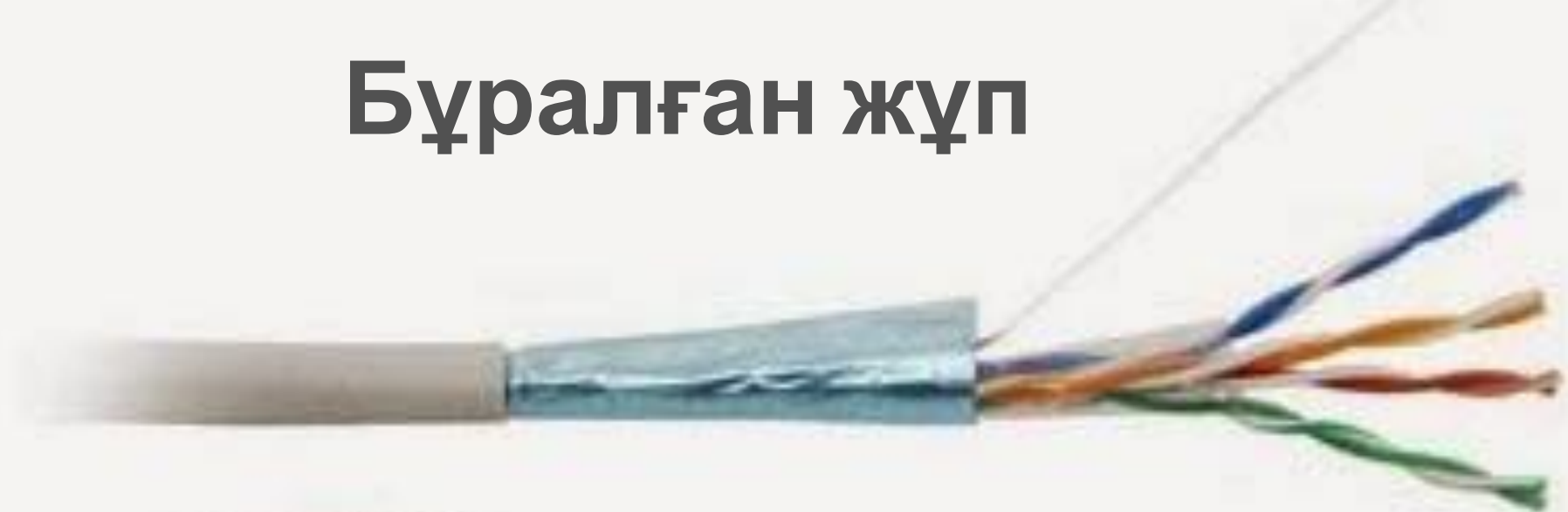

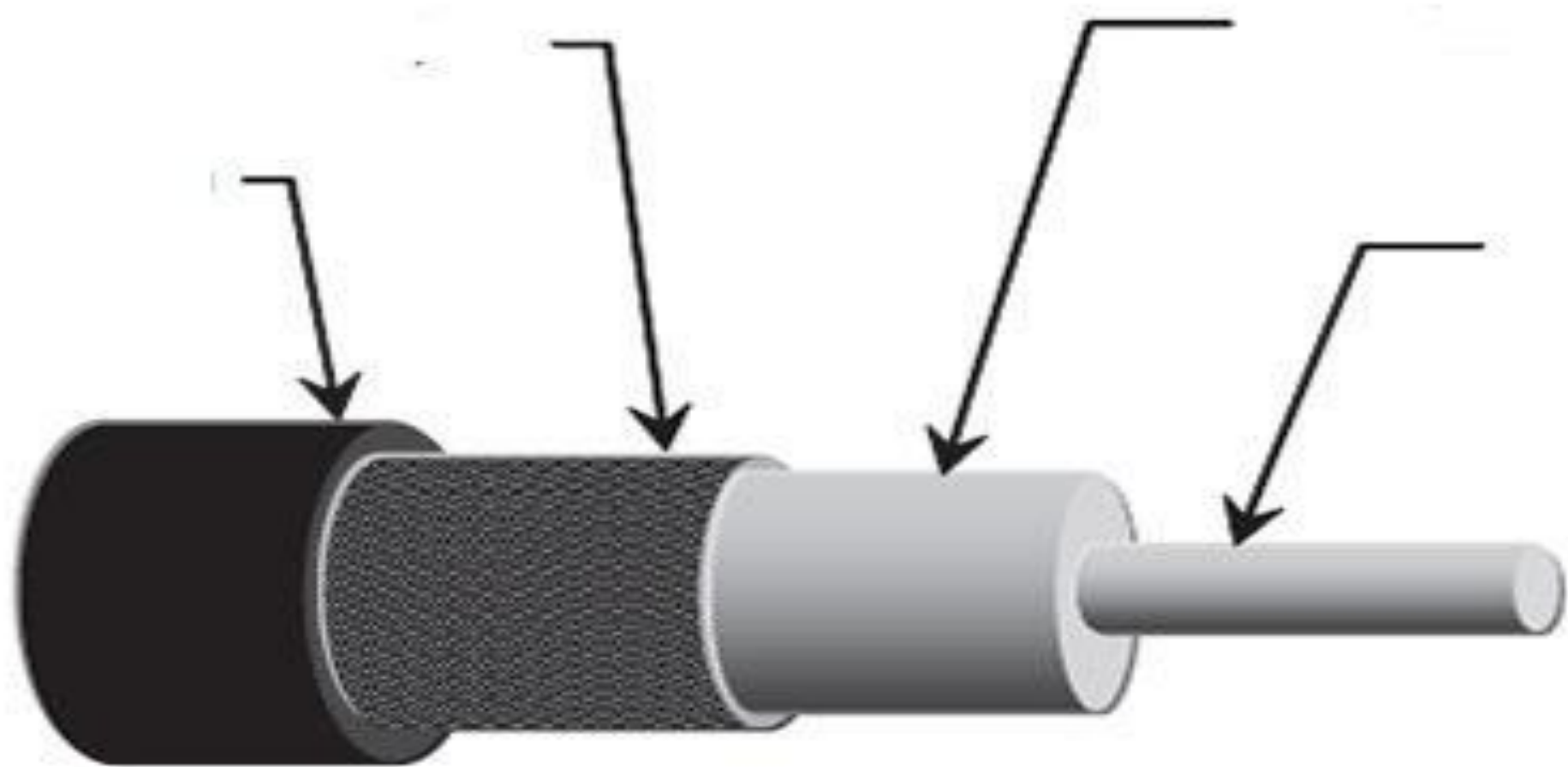

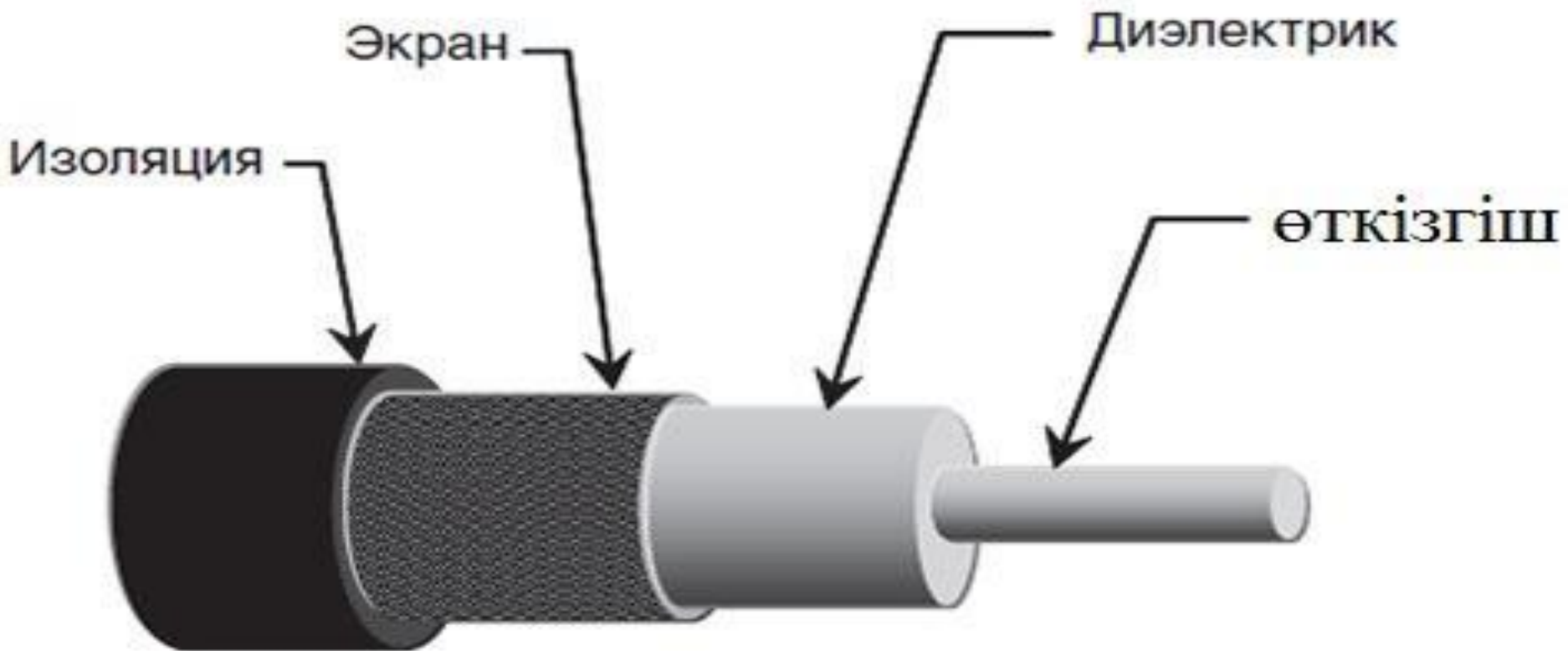

Коаксиалды кабель





Күштік кабель

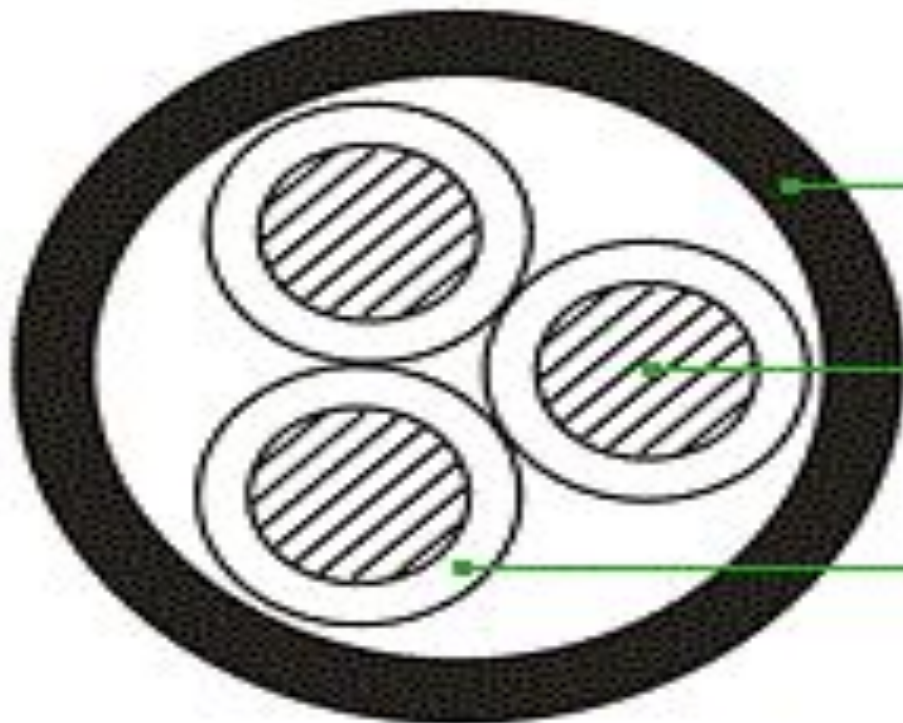

пластикті қаптама

алюминилі ток
өткізгіш

пластикті
оқшаулауыш





Арнайы кабель



3-КЕЗЕҢ : ҚҰРЫЛҒЫ

Суреттердің ішінен
Мегаомметр құрылғысын
тап?





**НАЗАРЛАРЫҢЫЗҒА
РАХМЕТ!!!**