

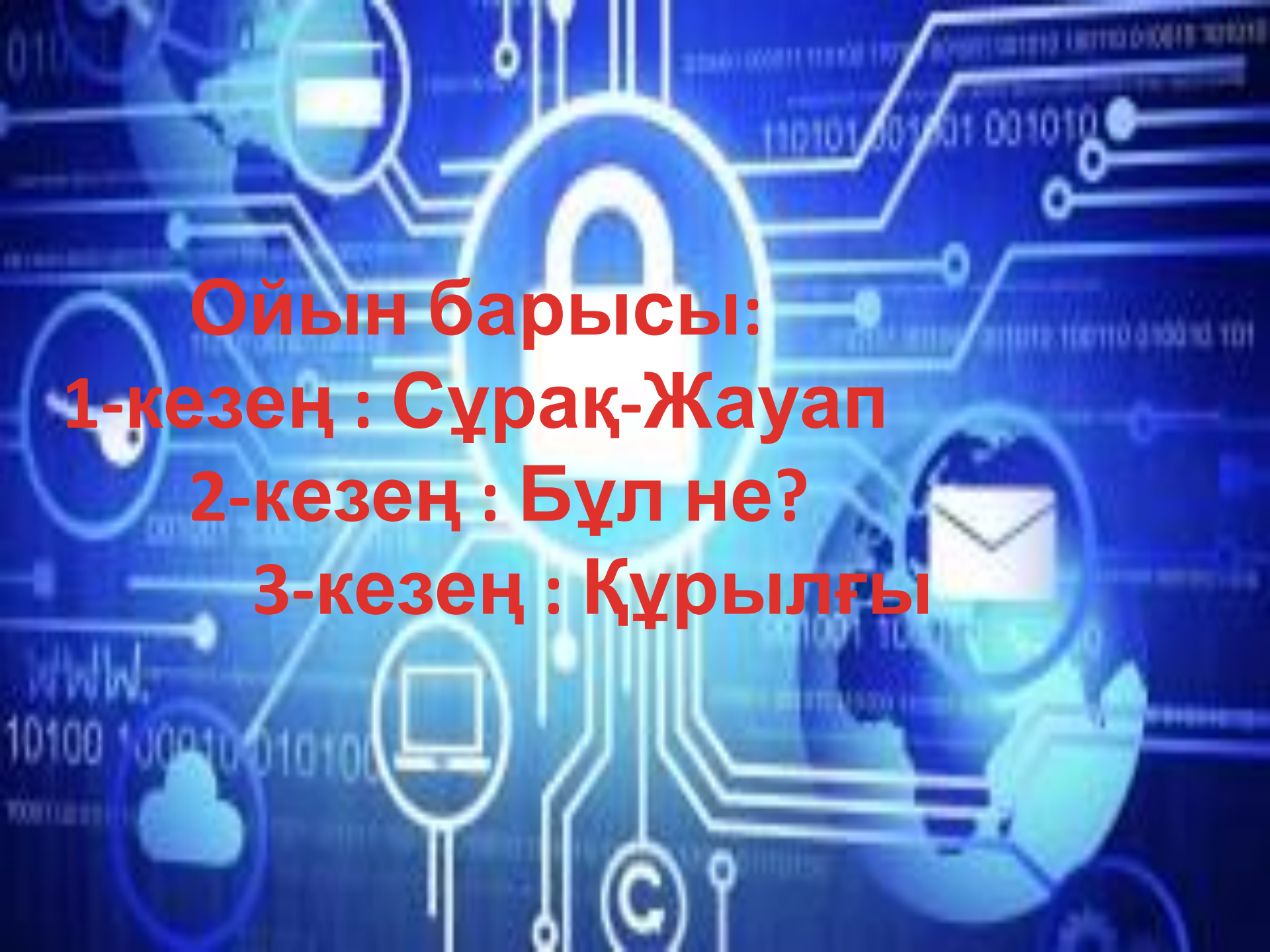

Байланыс негіздері



Ойын барысы:
1-кезең : Сұрақ-Жауап
2-кезең : Бұл не?
3-кезең : Құрылғы

2-кезең : Сұрақ-Жауа



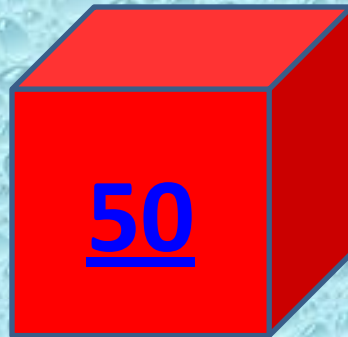
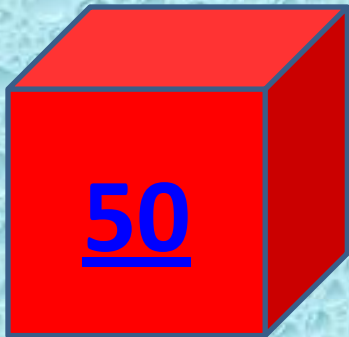
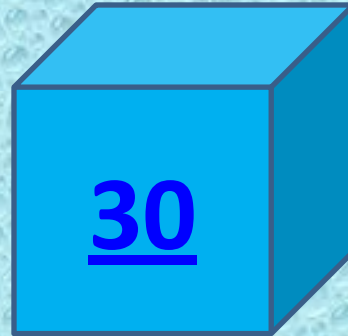
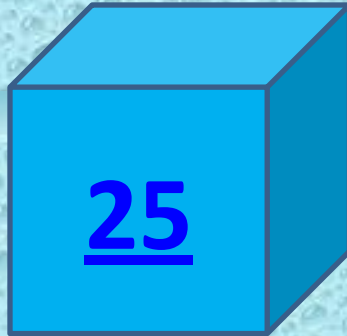
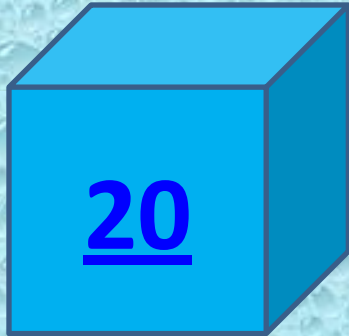
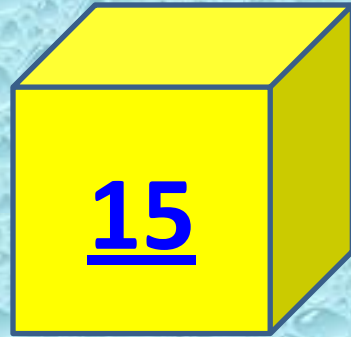
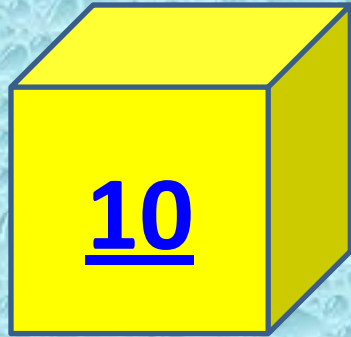
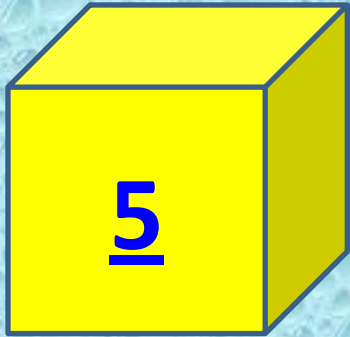

Кабель дегеніміз не?

**Қорғаныш қаптамасы
бар, бітеу қабыққа
салынған өткізгіш**

Сигнал дегеніміз не?

**Берілген хабарды
тасымалдайтын
физикалық процес**

Байланыс дегеніміз не?

Бір жерден екінші жерге
хабар алмасу процесі

**Кабель сөзінің голл.
мағынысы?**

Қанат,сым арқан

**Ақпарат кабеліне
жататындары атаңыз?**

**Антенна, телефон,
компьютер кабельдері
т.б. жатады**

**Кабельдің ақауын
тексеретін құрылғы?**

Мегаомметр

**1984 жылы әзірленген
базалық модель?**

OSI

(Open System Interconnection)

**Ауыспалы және
фазалық біртектіліктің
тәртібін анықтауға
арналған техникалық
операция?**

Фазировкалау

3-кезең : Бұл не?



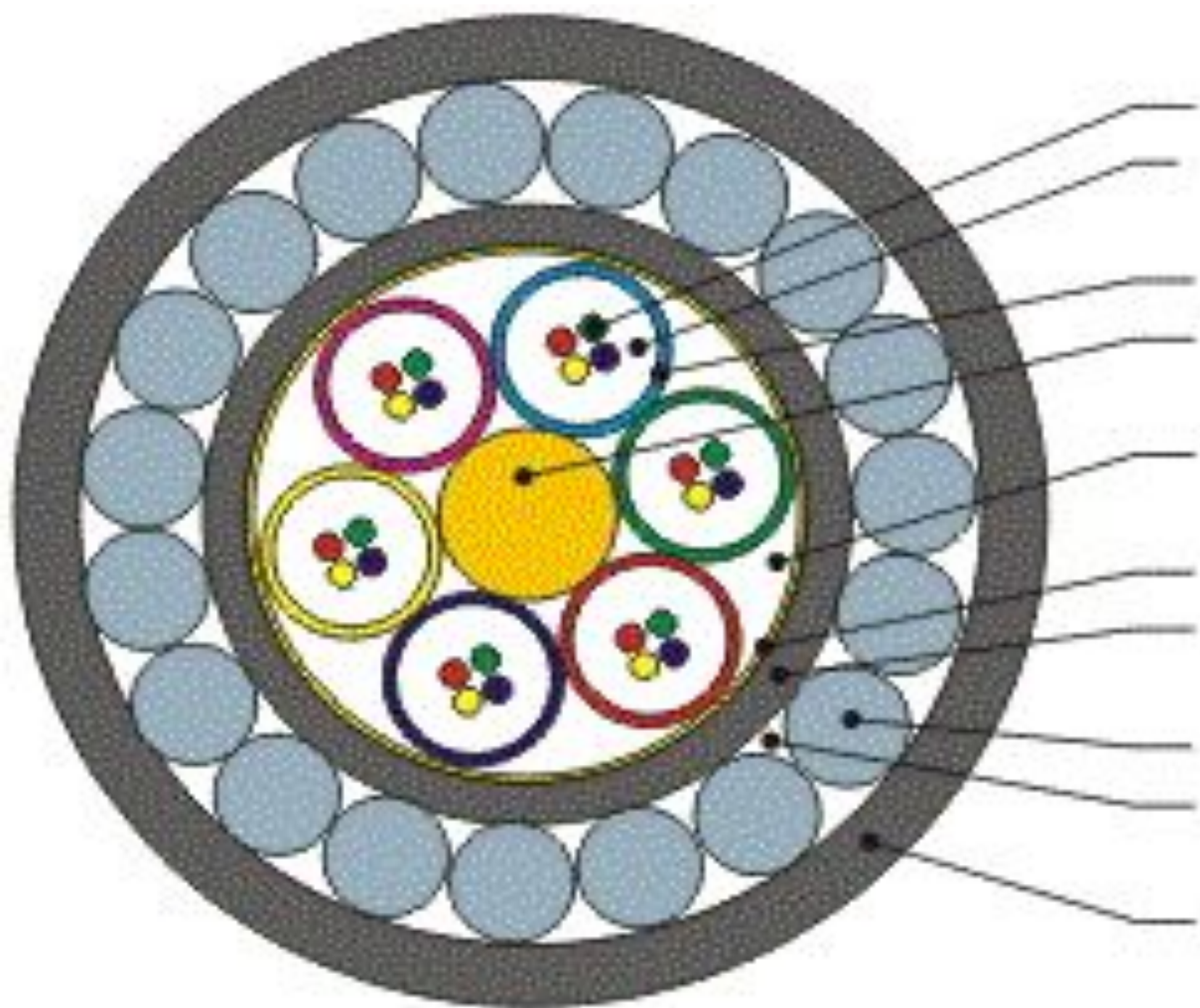

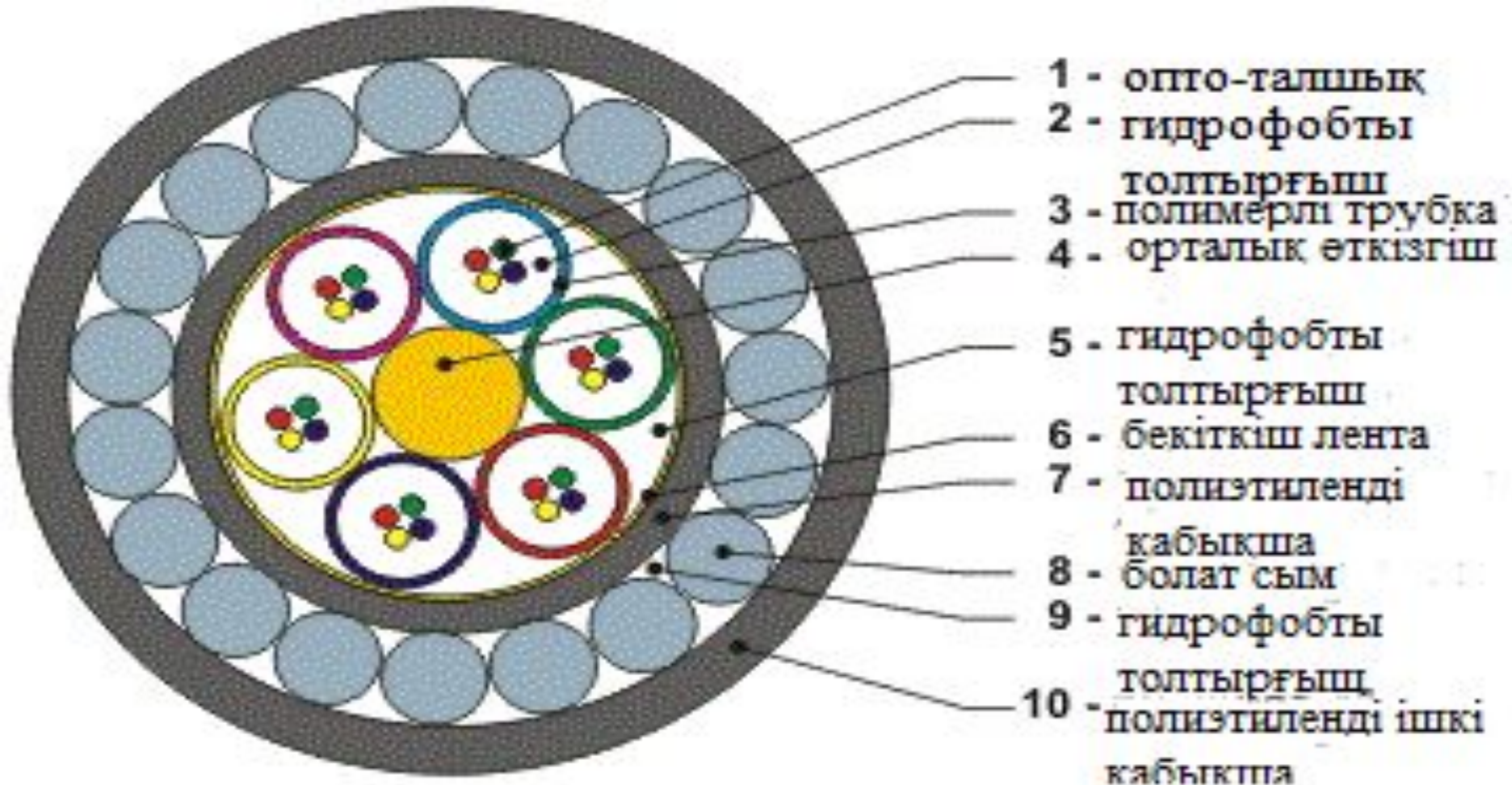

ОПТО-ТАЛШЫҚТЫ КАБЕЛЬ

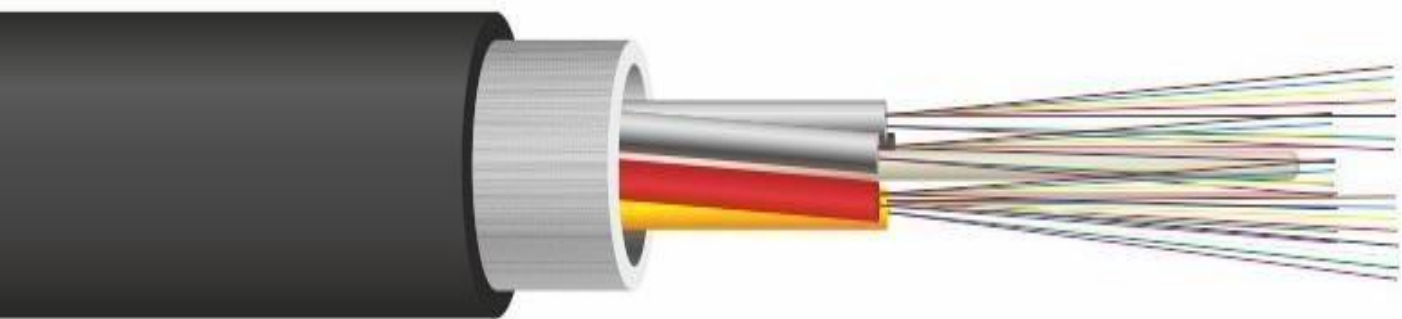



LED-OBZOR.ru



Жарықты-диодты кабель

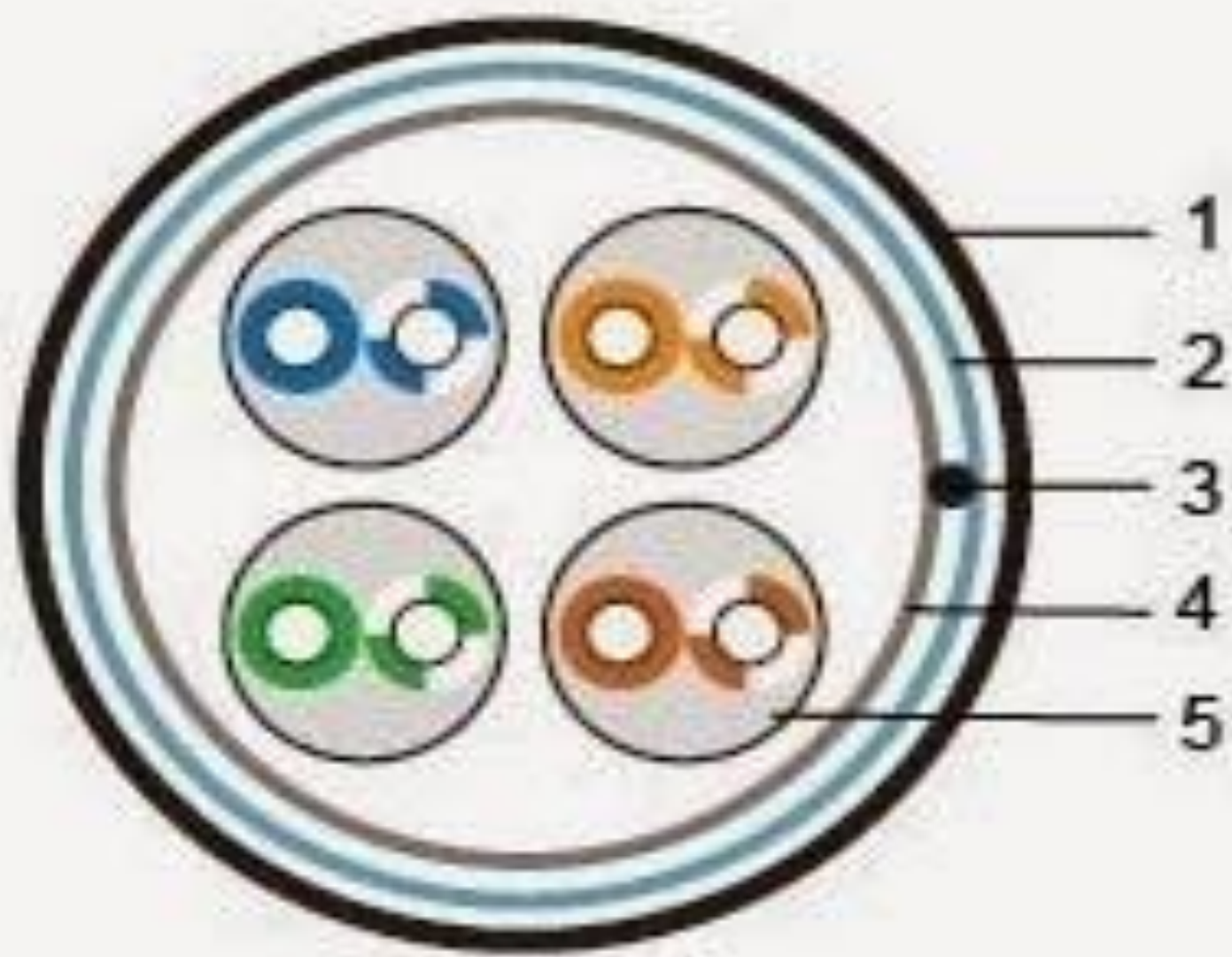

Бұралған жұп

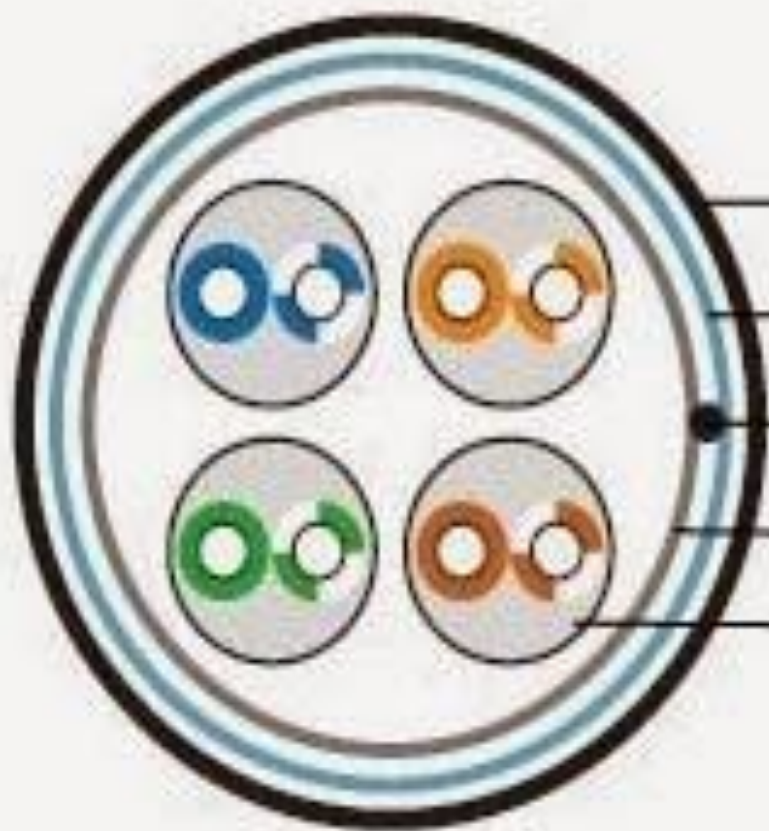
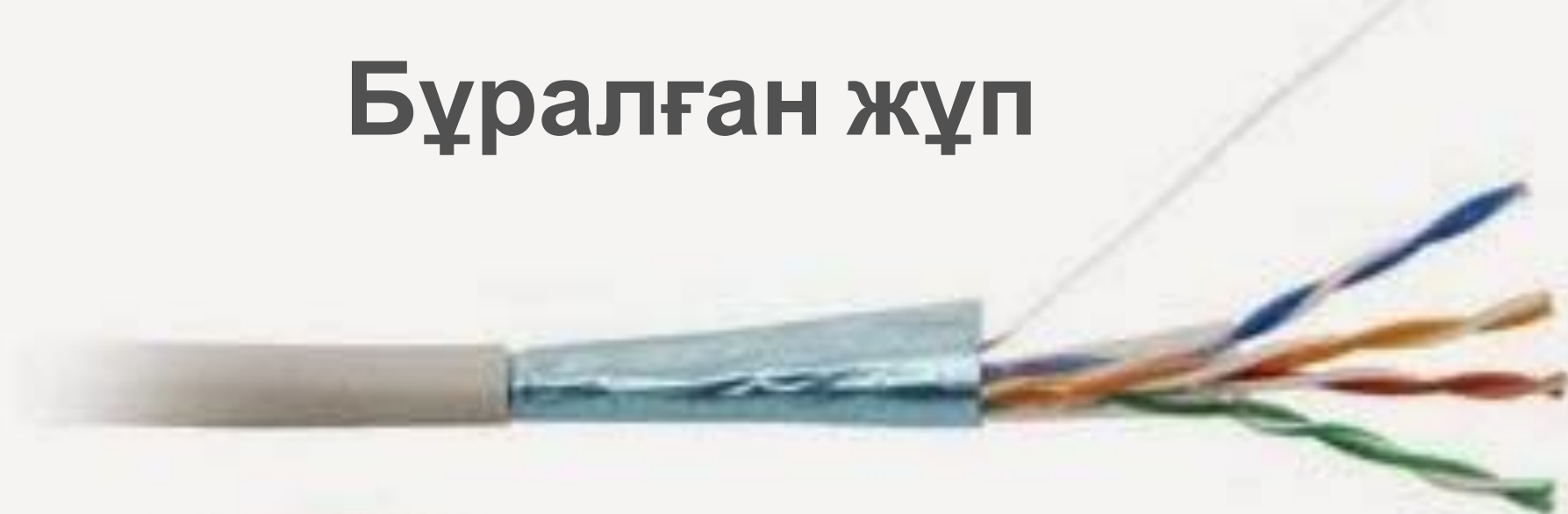

- 1-сыртқы қабық
- 2-фольгалы экран
- 3-кептіргіш сым
- 4-қорғаушы пленка
- 5-бұралған жұп

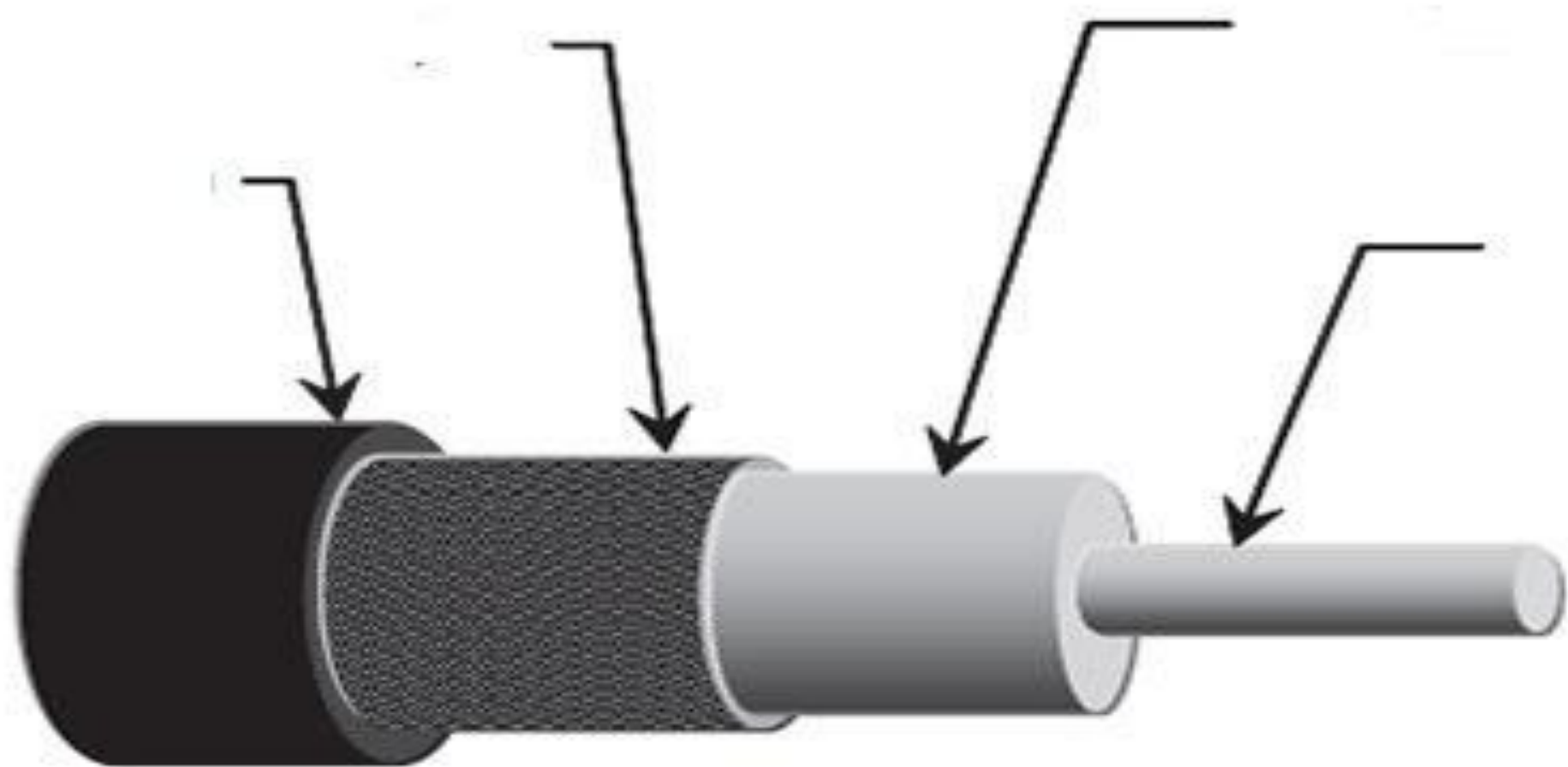

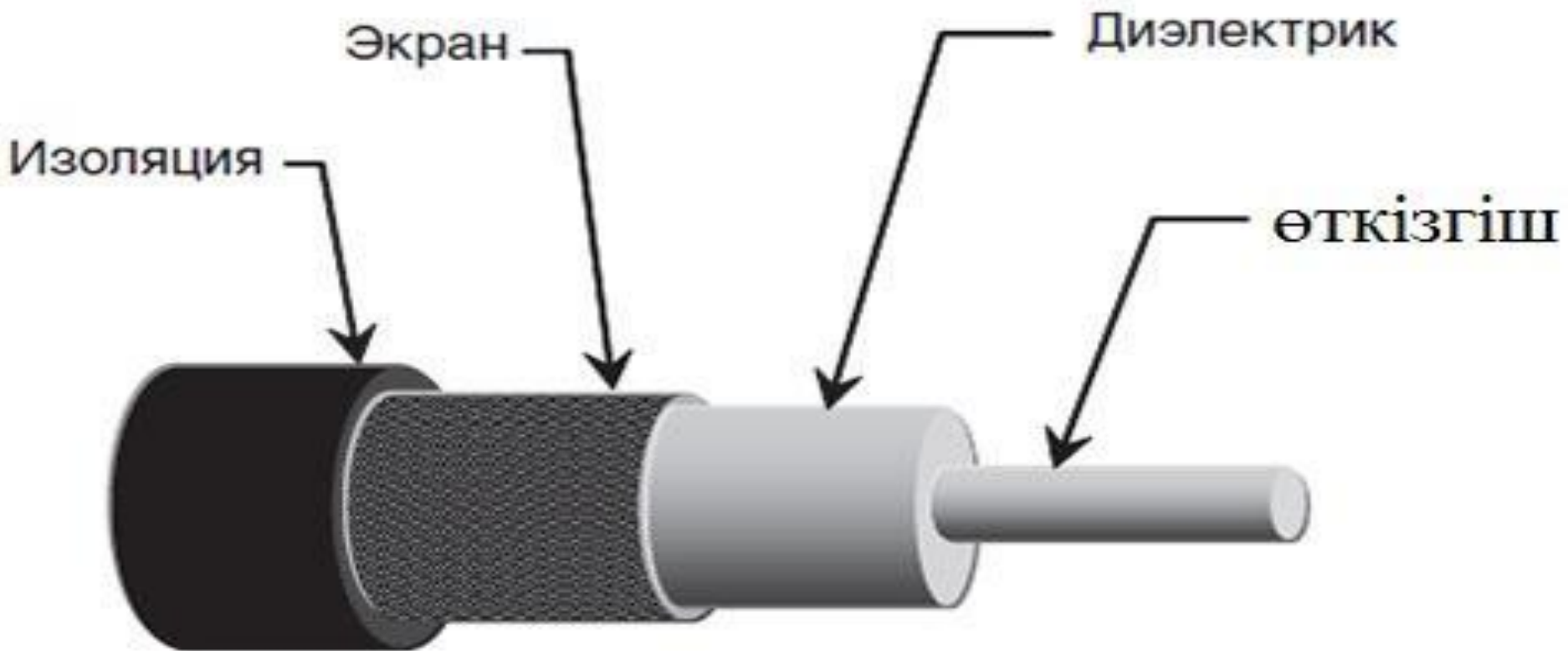

Коаксиалды кабель





Күштік кабель

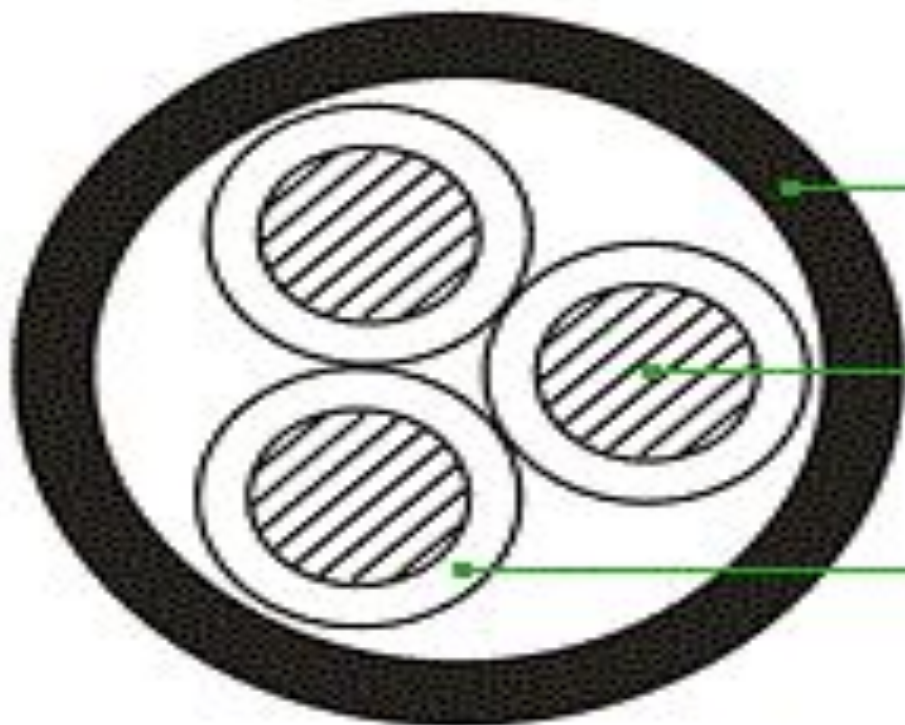

пластикті қаптама

алюминилі ток
өткізгіш

пластикті
оқшаулауыш





Арнайы кабель



3-КЕЗЕҢ : ҚҰРЫЛҒЫ

Суреттердің ішінен
Мегаомметр құрылғысын
тап?





**НАЗАРЛАРЫҢЫЗҒА
РАХМЕТ!!!**