

Параллелограмм

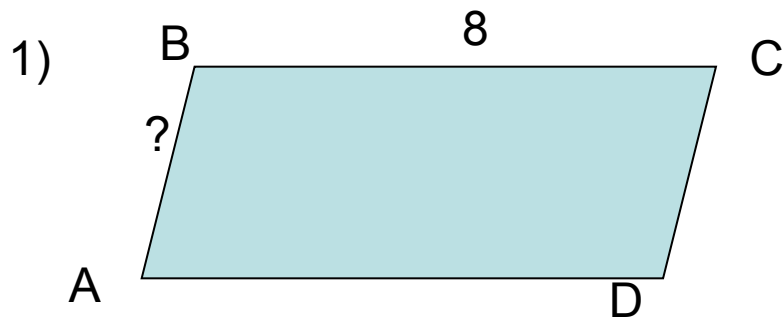

$$P=28$$

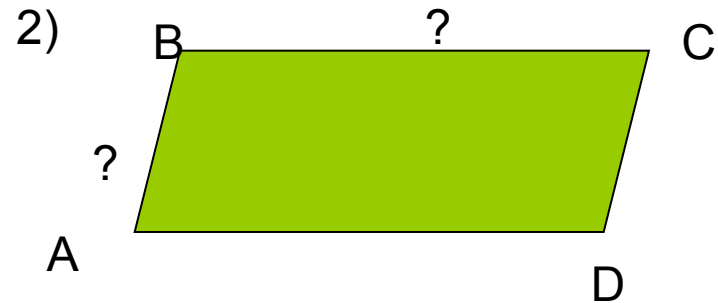

$$P=30; \quad BC=4AB$$

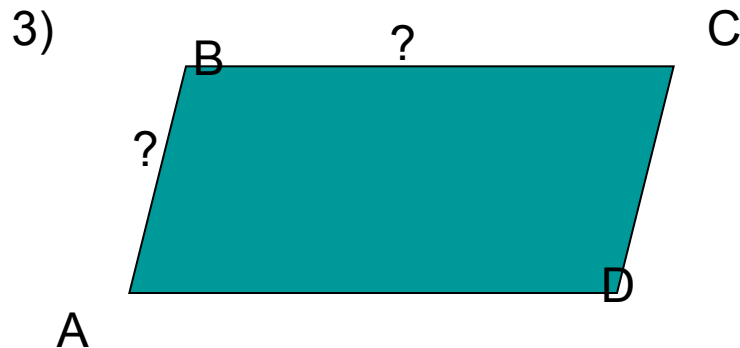

$$BC > AB \text{ на } 10$$

$$P=68$$

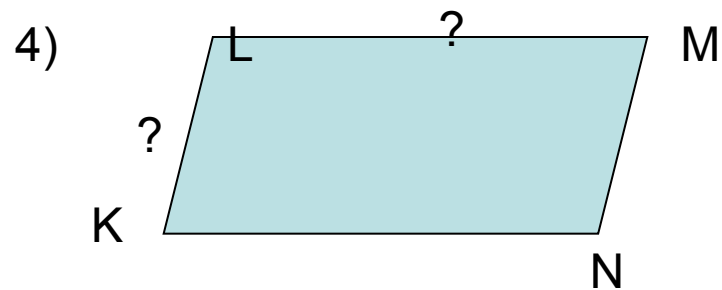

$$P=20; \quad KN - MN = 2$$

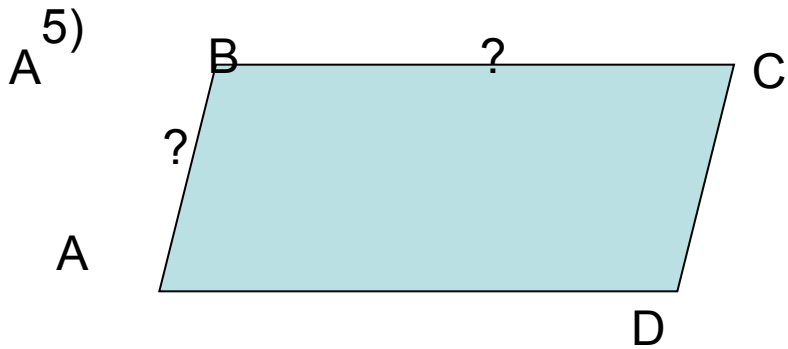

$P=16$; $AD > AB$ в 3раза

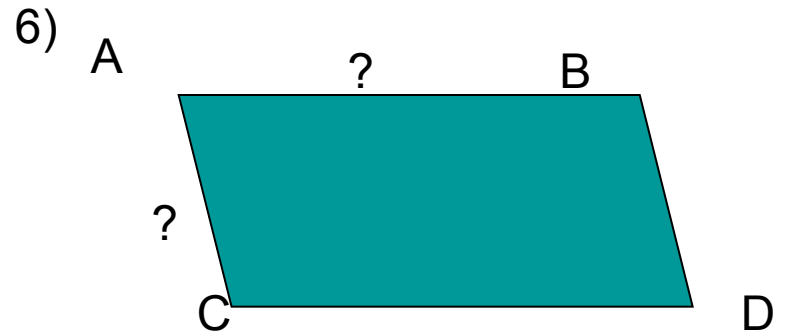

$P = 28$; $AD : AB = 4:3$

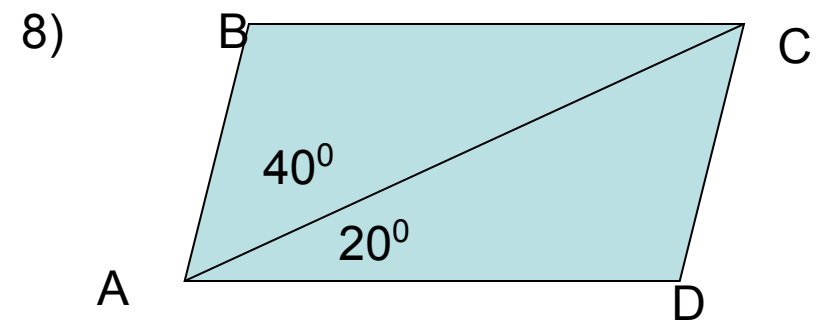
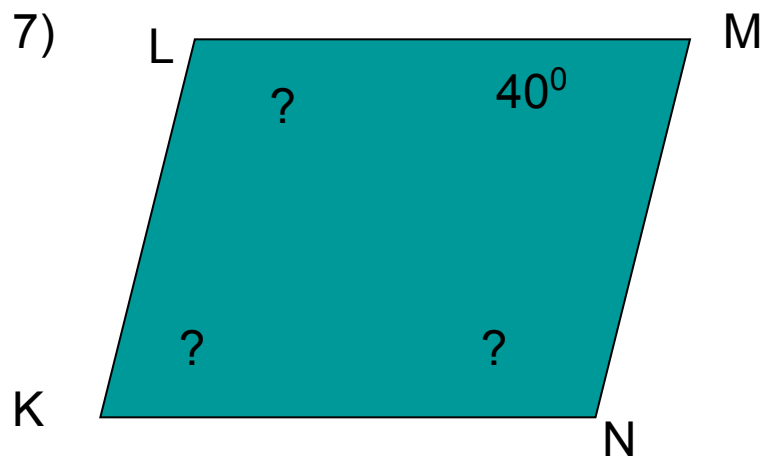

$\angle B - ?$; $\angle C - ?$

9)

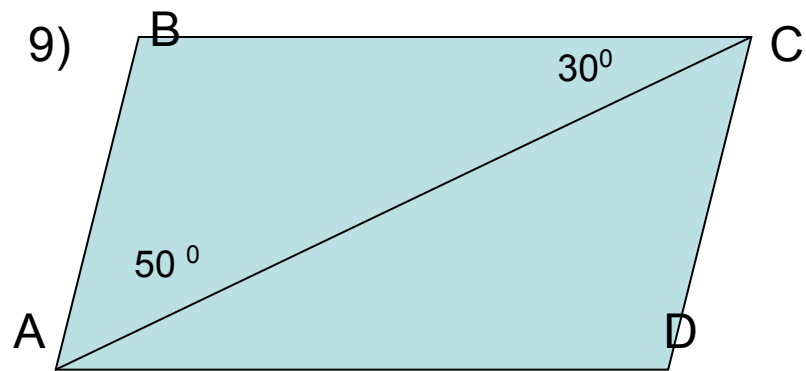

$$\angle A - ?; \angle B - ?$$

10)

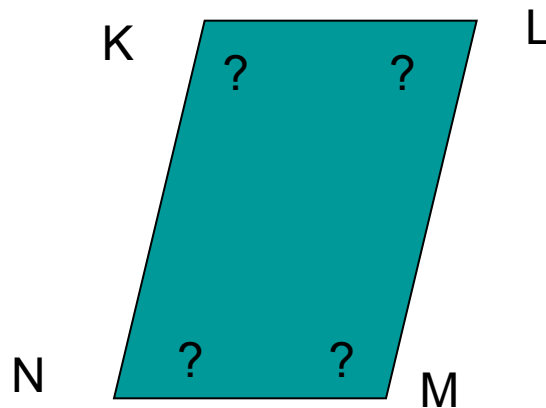

$$\angle L - \angle K = 60^\circ$$

11)

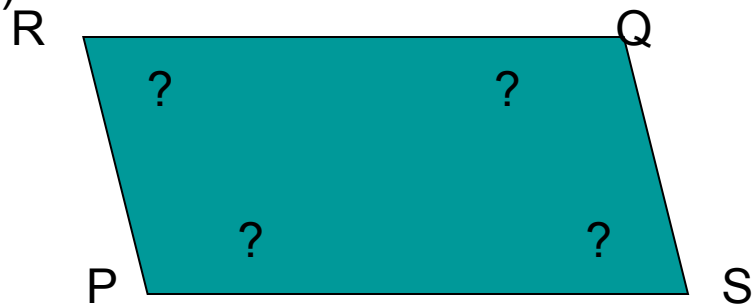

$$\angle P > \angle R \text{ в } 8 \text{ раз}$$

12)

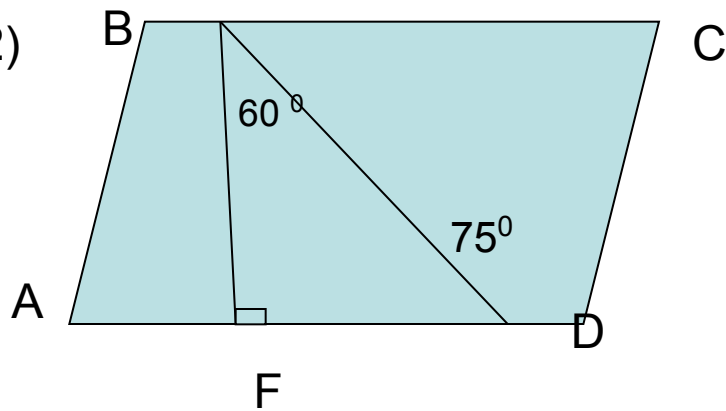

$$\angle A - ?; \angle B - ?$$

D13)

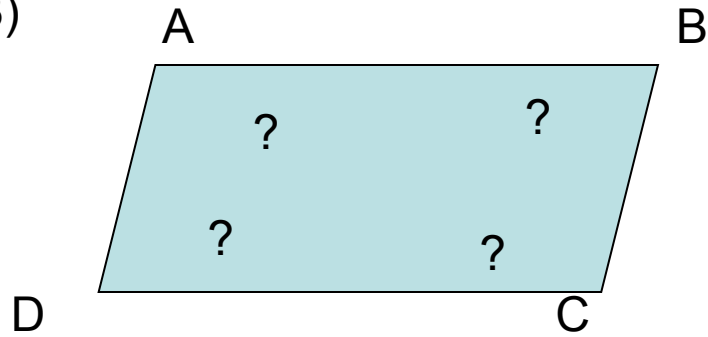

$$\angle A > \angle B \text{ в } 2 \text{ раза}$$

14)

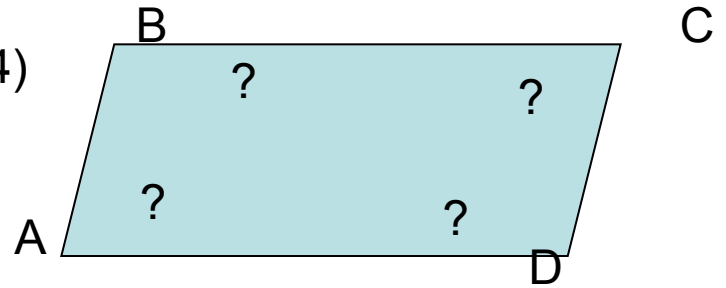

$$\angle B > \angle C \text{ на } 50^\circ$$

15)

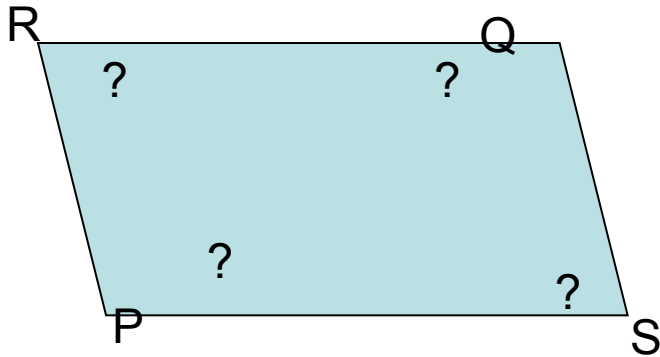

$$\angle R > \angle Q = 2 : 3$$

16)

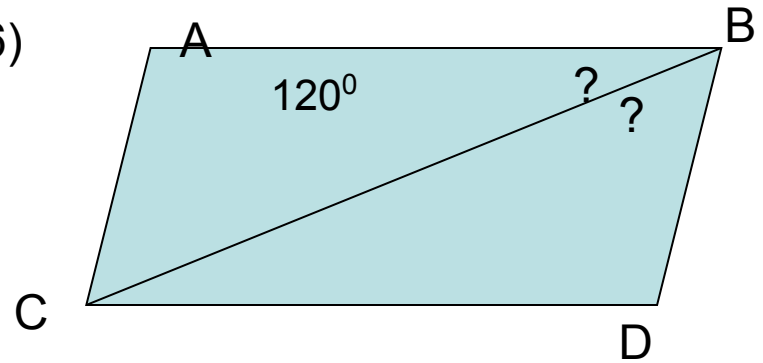

$$\angle ABC : \angle CBD = 1 : 2$$

17)
17)

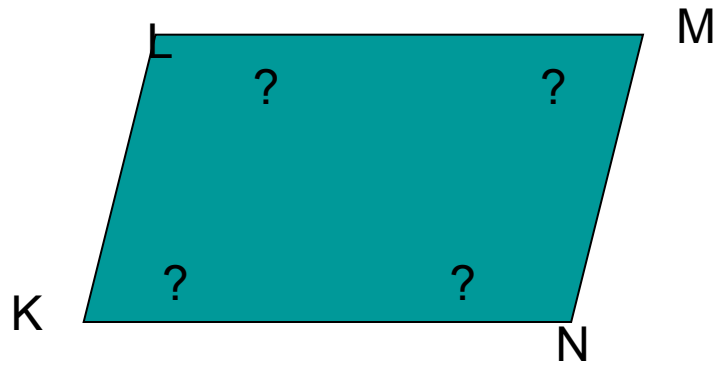

Сумма трех углов равна 230°

18)

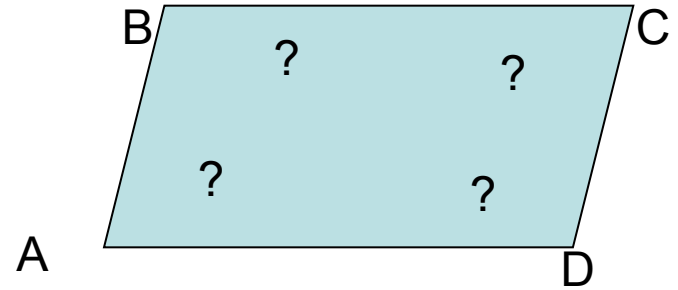

Сумма двух углов равна 100°

19)

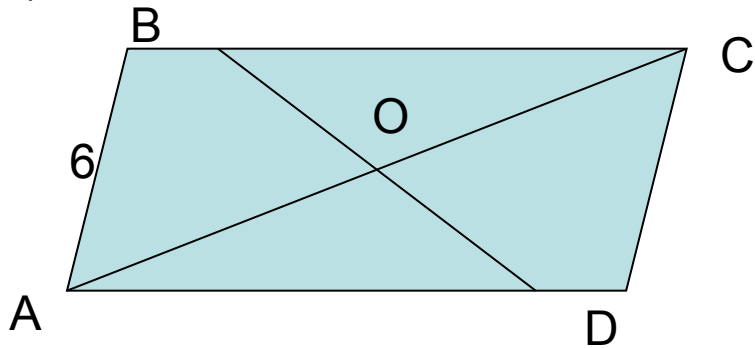

$AC=9$; $BD=5$; $P_{AOB}=?$

20)

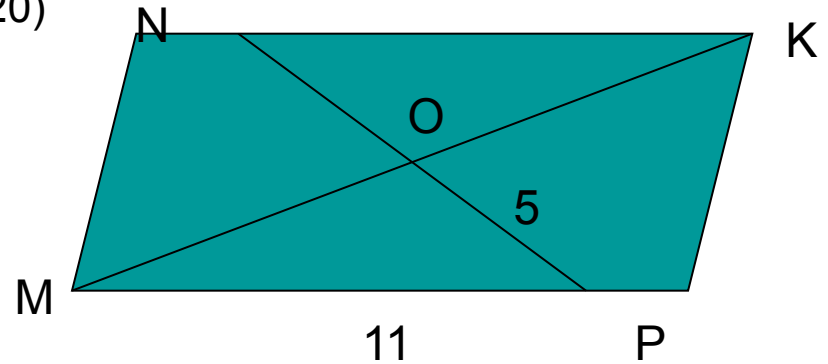

$MK=18$; $P_{ONK}=?$

21)

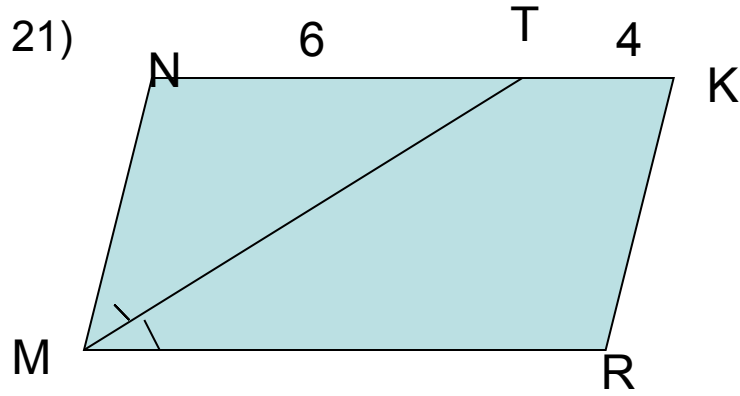

$P = ?$

22)

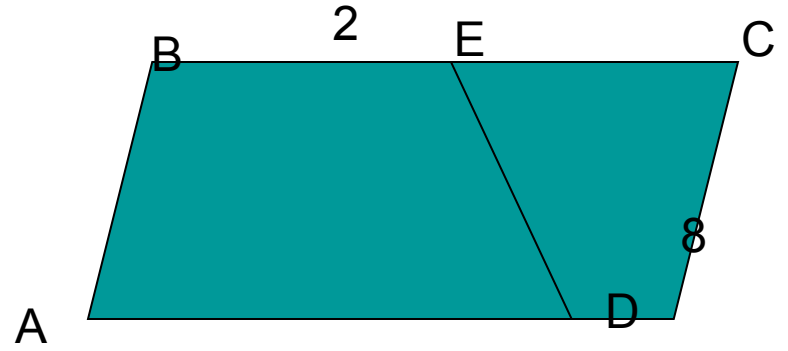

DE – биссектриса; $P = ?$

23)

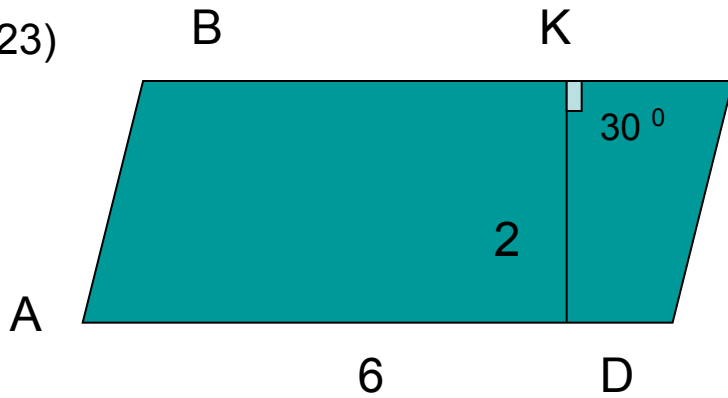

$P = ?$

C

24)

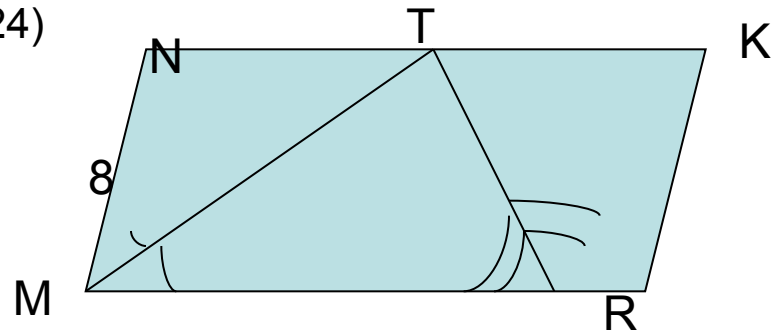

$P = ?$

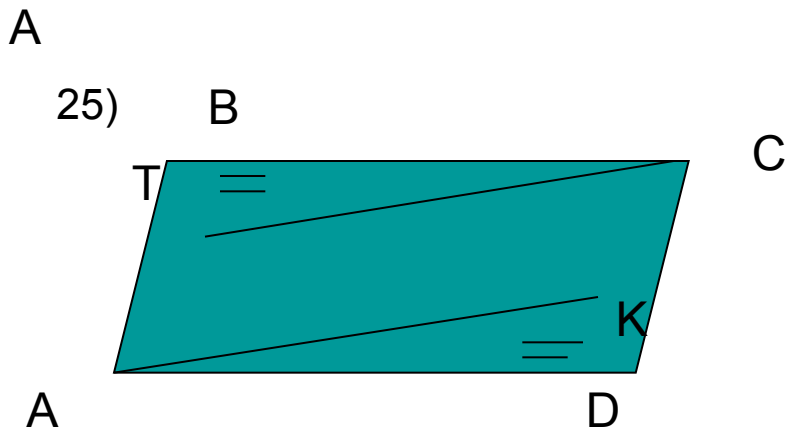

Докажите, что $ATCK$ -
параллелограмм

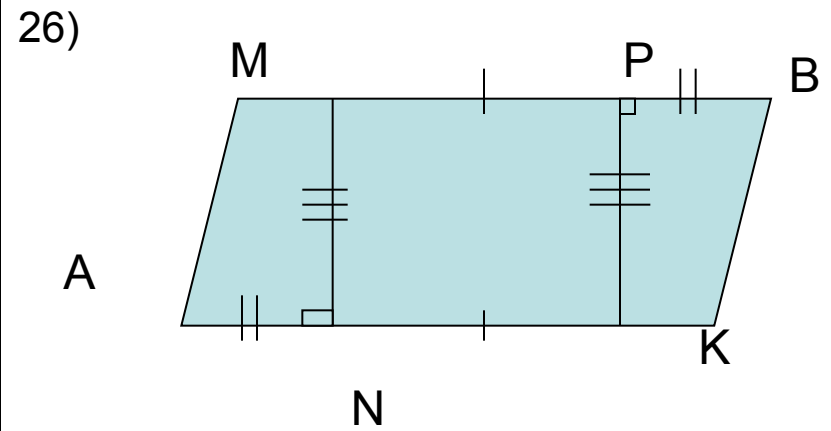

Докажите, что $AMBK$ -
параллелограмм

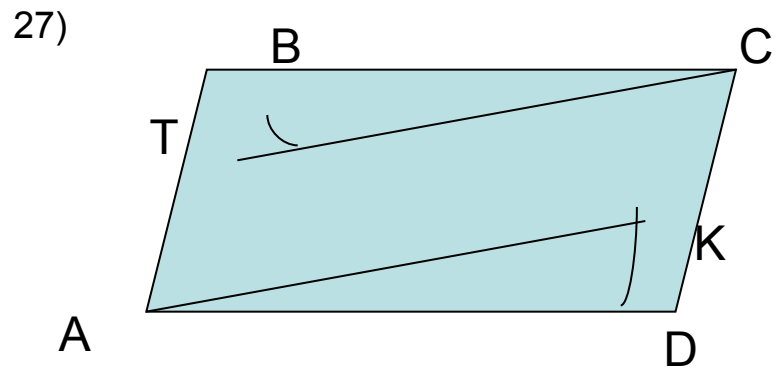

Докажите, что $ATCK$ -
параллелограмм

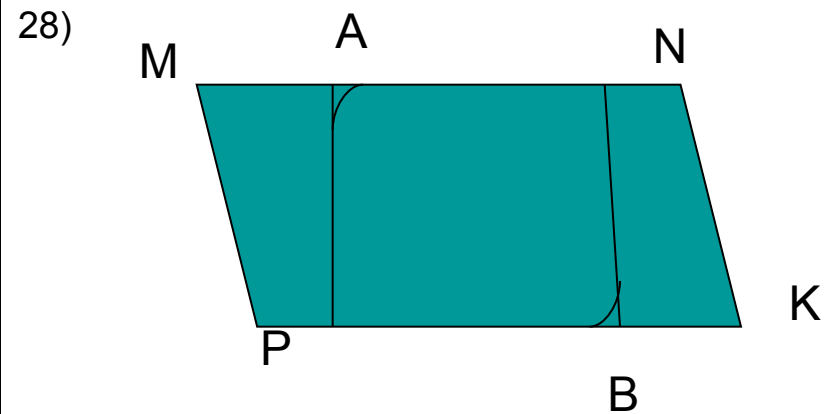

Докажите, что $ANBP$ -параллелограмм

29)

29)

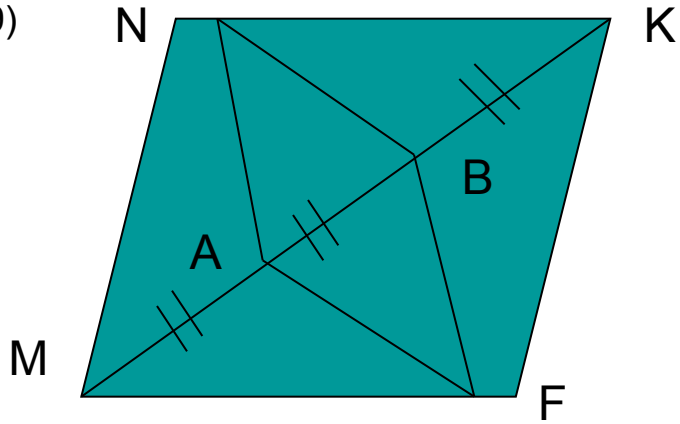

Докажите, что NAFB - параллелограмм

30)

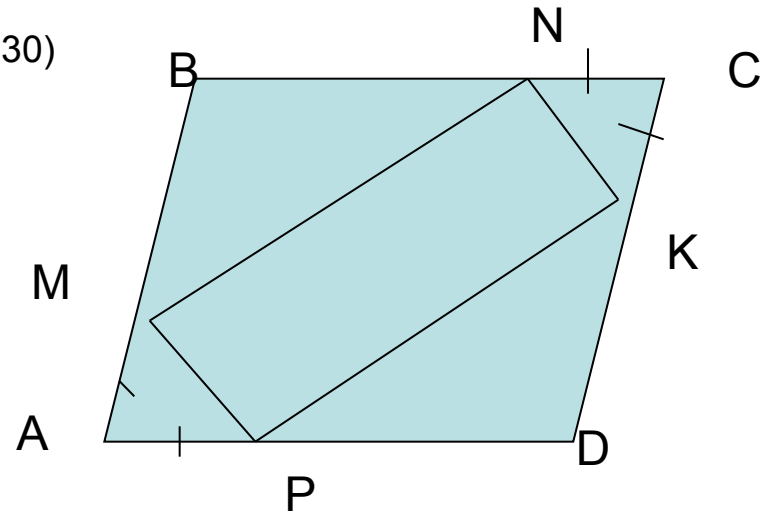

Докажите, что MNKP - параллелограмм

31)

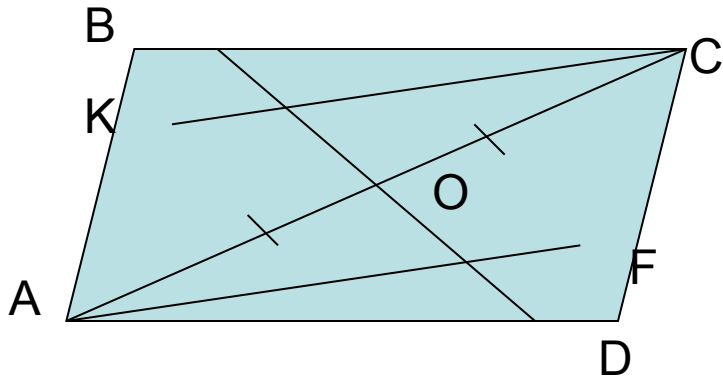

Дано: AKCF - параллелограмм

Доказать: ABCD - параллелограмм

32)

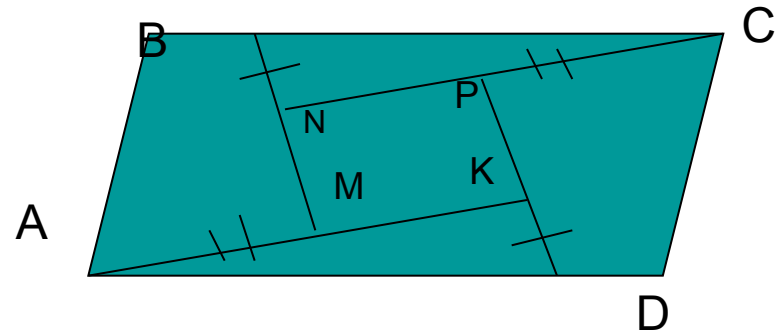

Дано: MNPК - параллелограмм

Доказать: ABCD - параллелограмм