

# Импровизированные НОСИЛКИ

# ИЗГОТОВЛЕНИЕ НОСИЛОК С ПОМОЩЬЮ ПОДРУЧНЫХ СРЕДСТВ

## 1. Использование плащ-палатки, брезента, одеяла



# Использование лямки



Рис. 64. Специальная ляжка Ш-4  
1 – собственно ляжка, 2 – стальные карабины, 3 – пряжки-пыжистенки, 4 – металлические кольца, 5 – металлическая пряжка, 6 – брезентовая накладная полоска





# Использование двух простыней

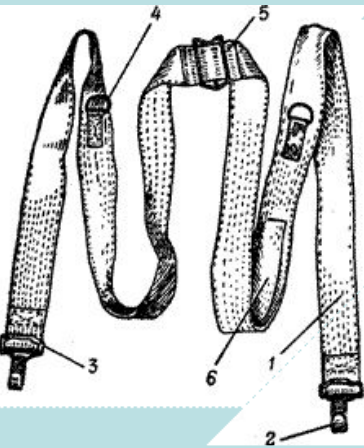
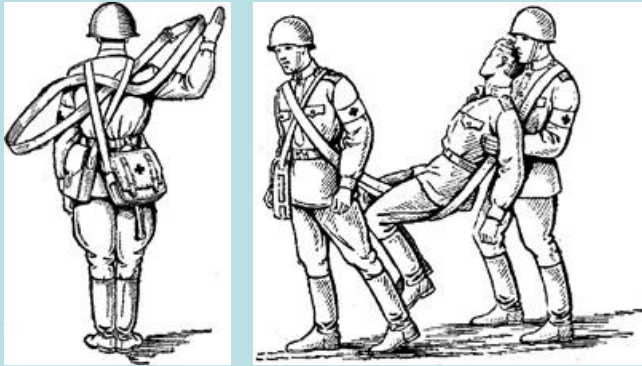
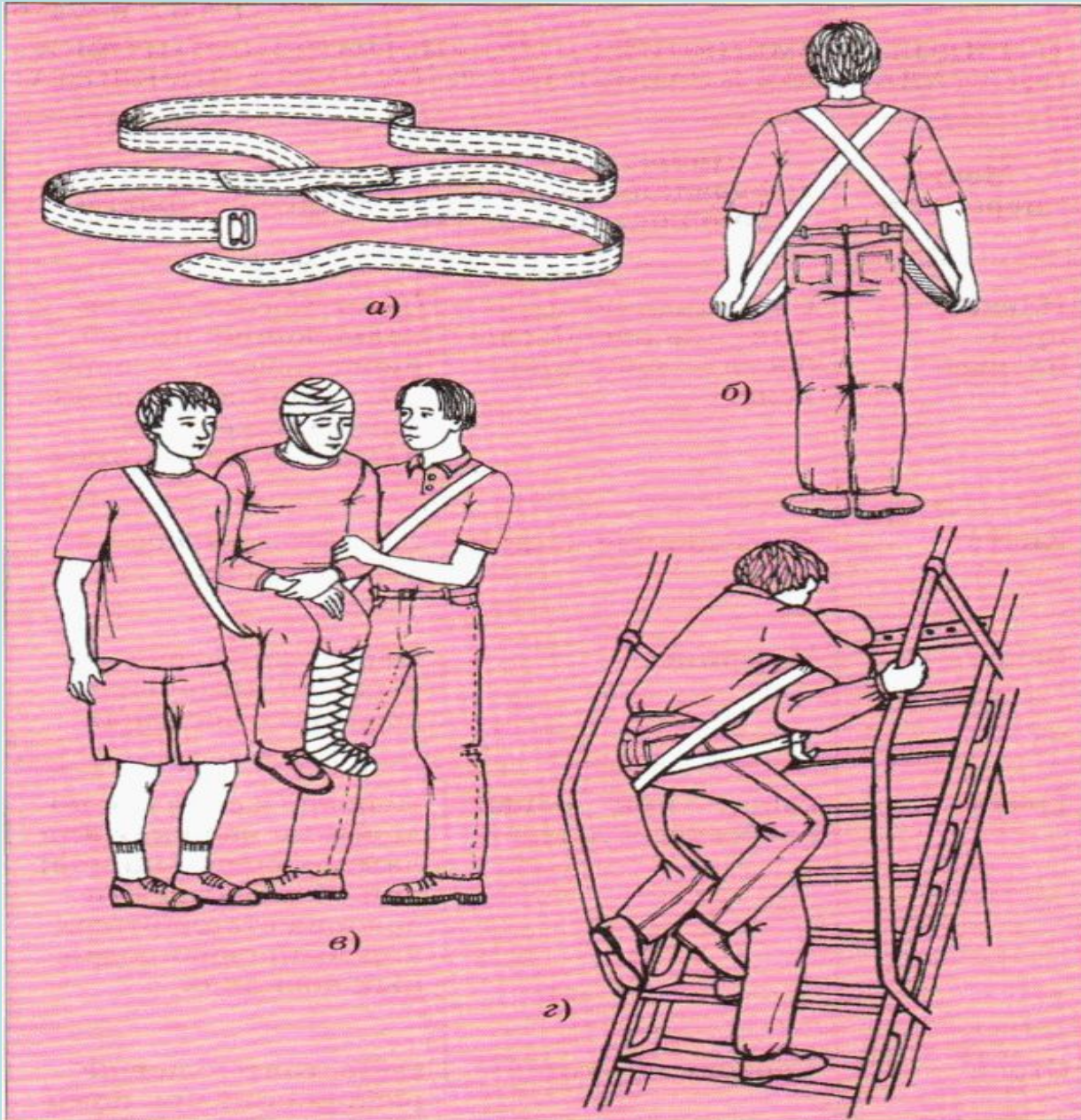
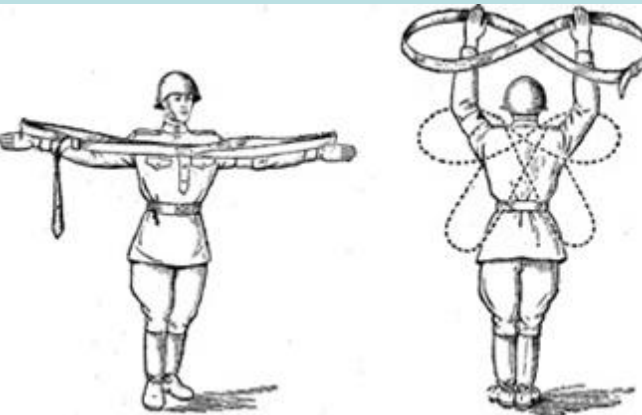
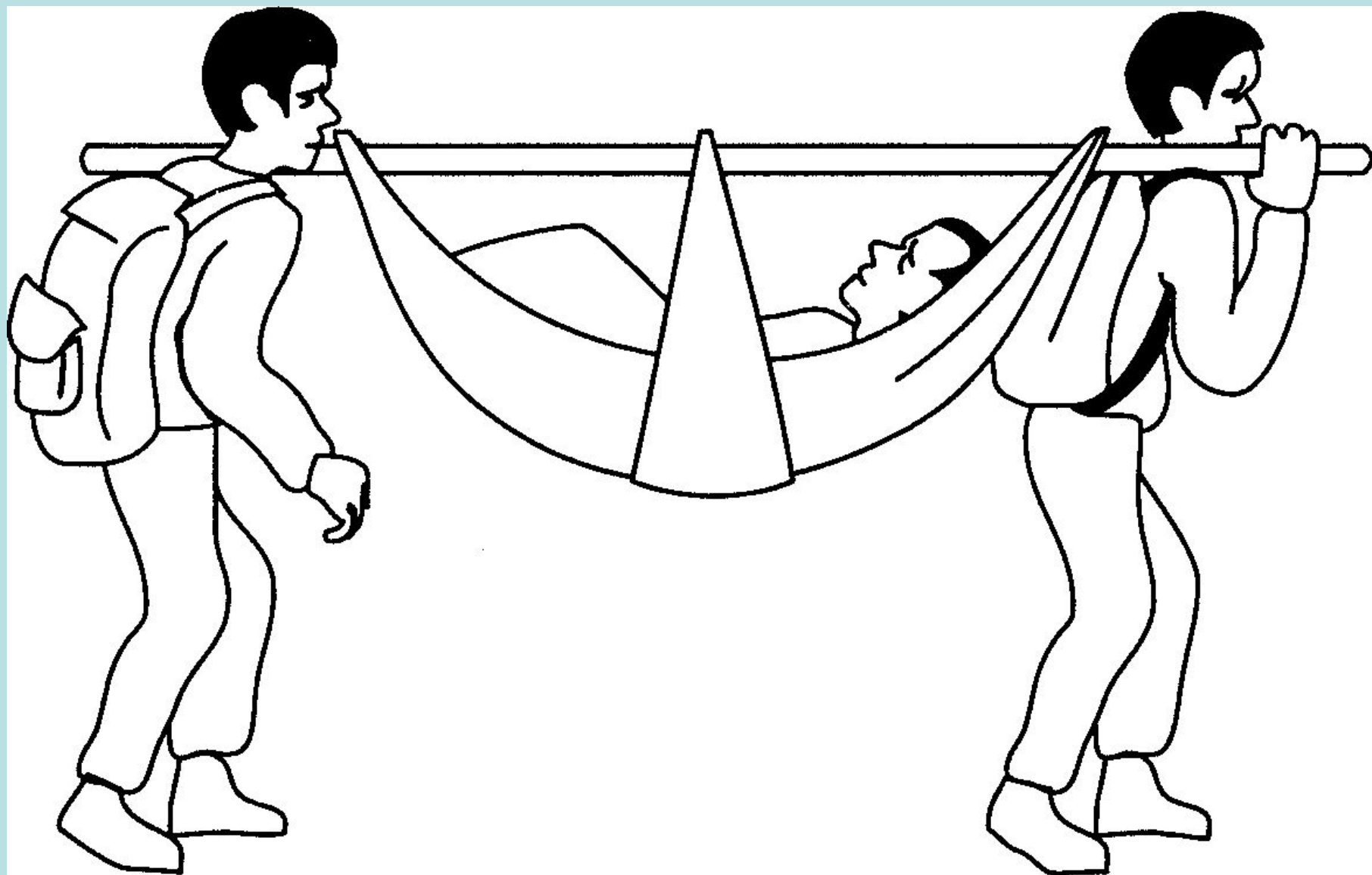

# Использование одежды

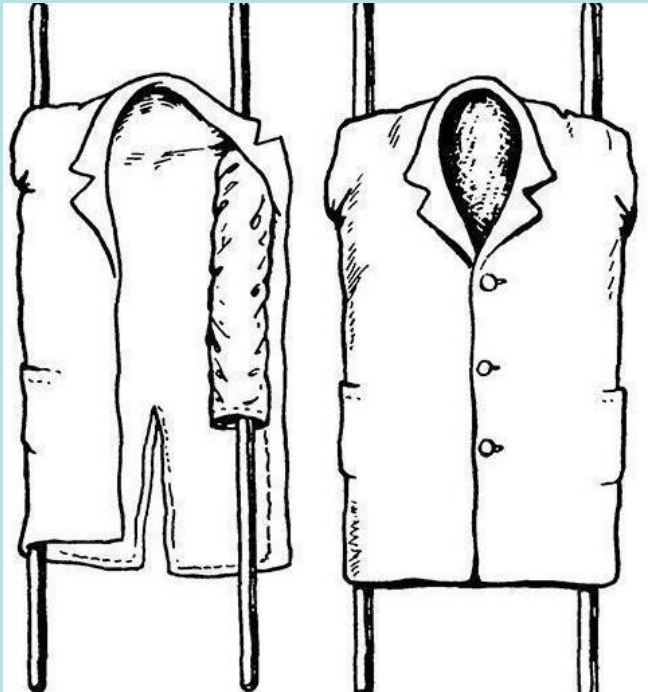
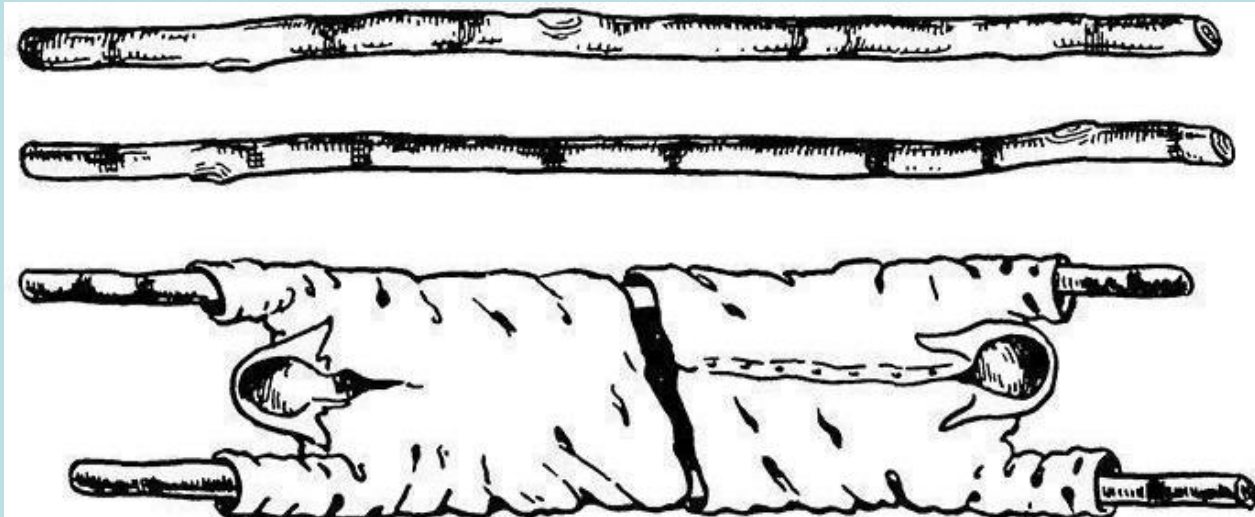

# Использование бытовых предметов

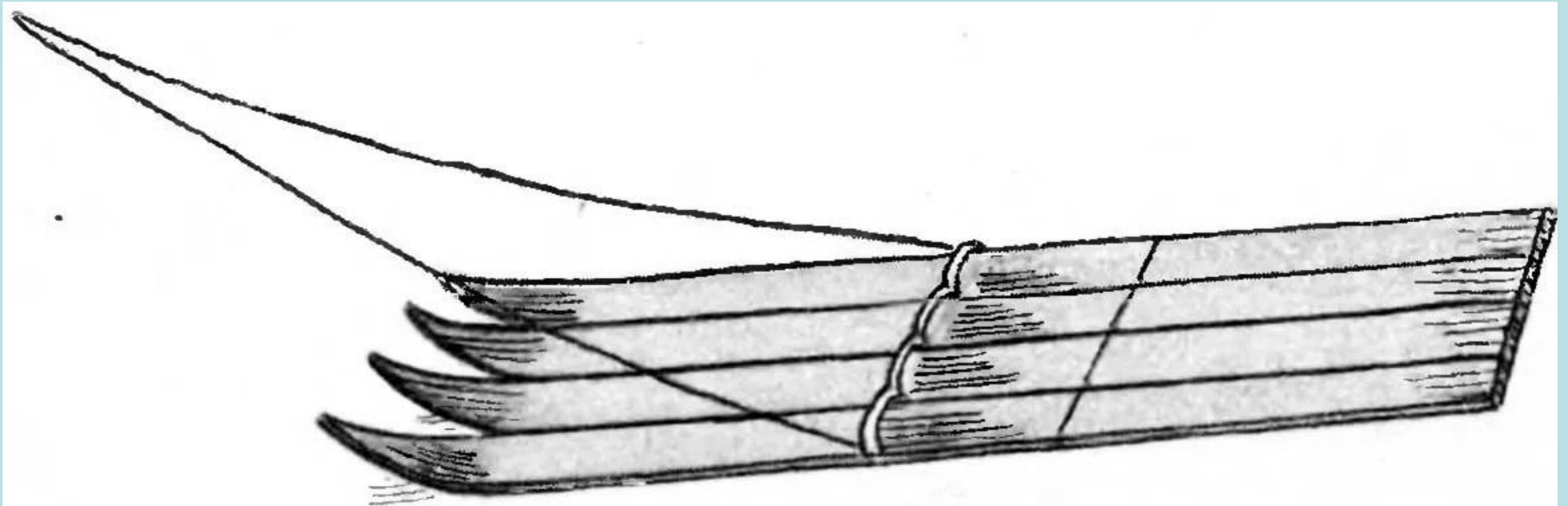
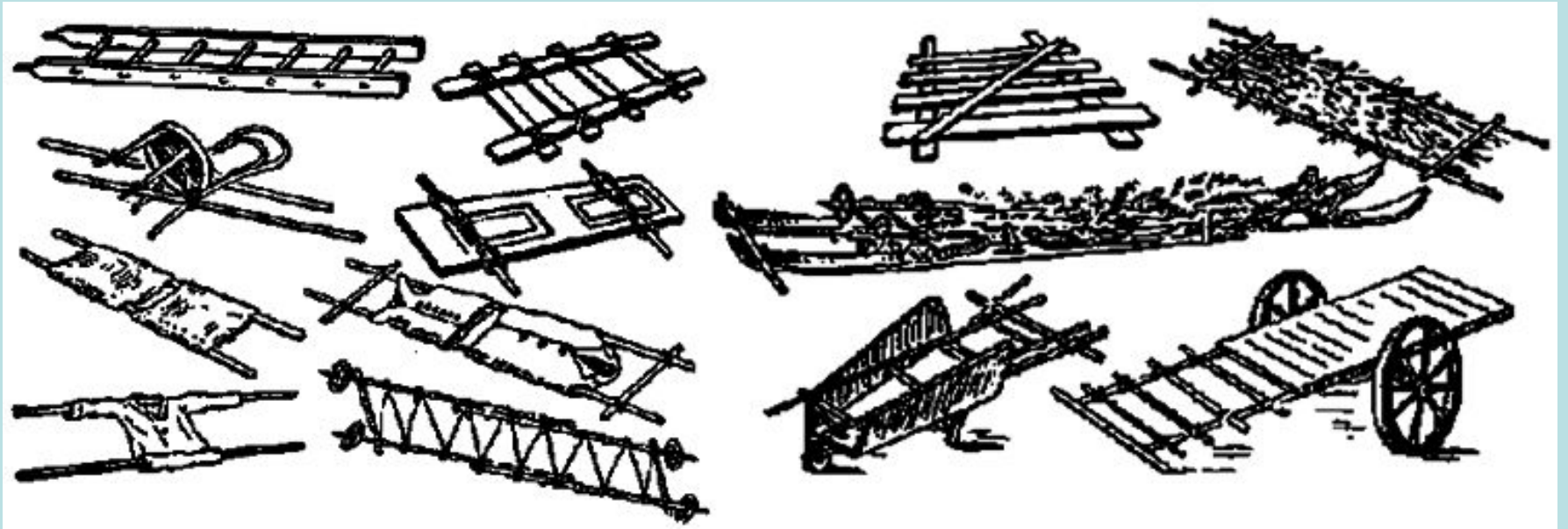

# Изготовление

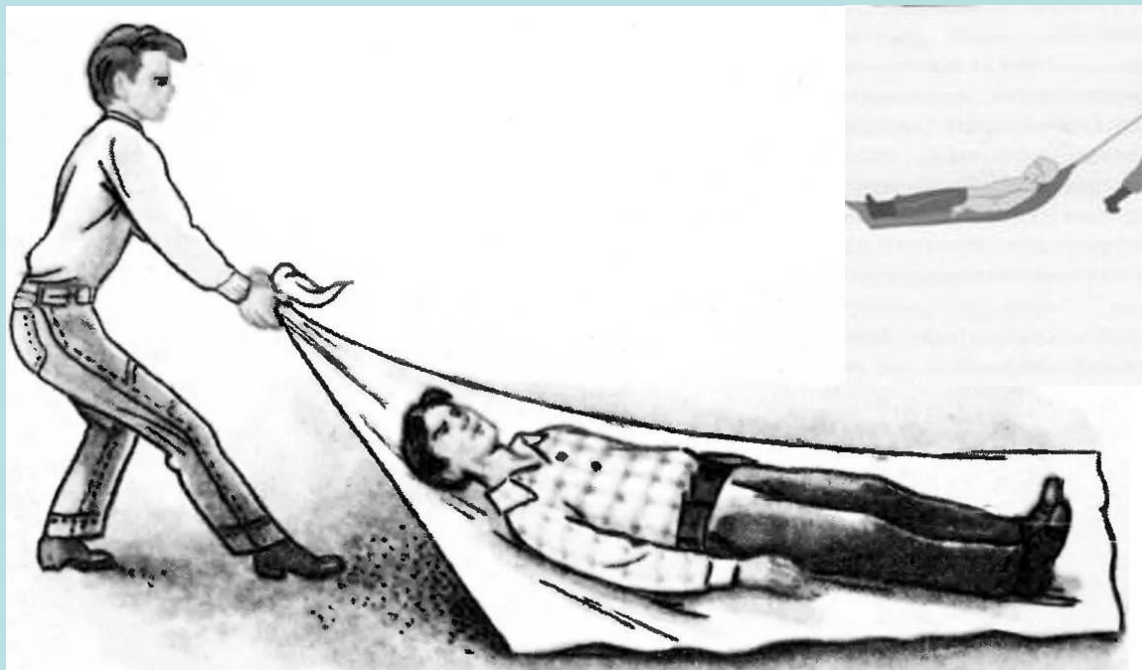
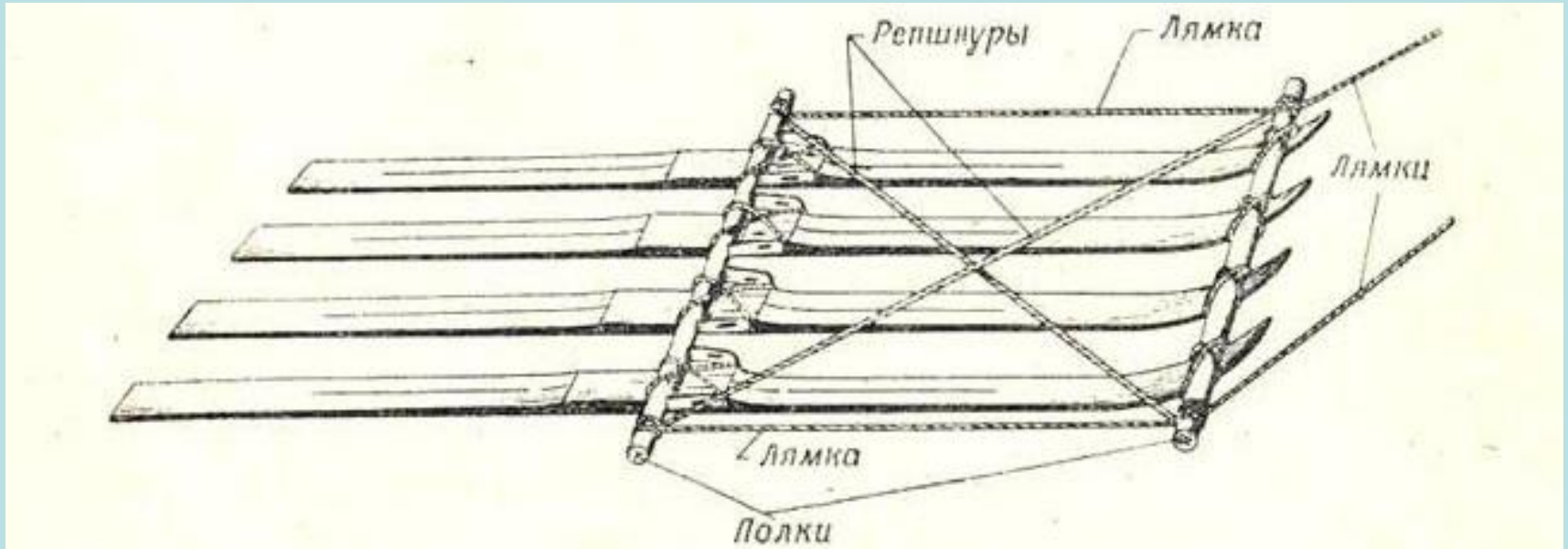



# Использование лыж в сочетании с верёвкой

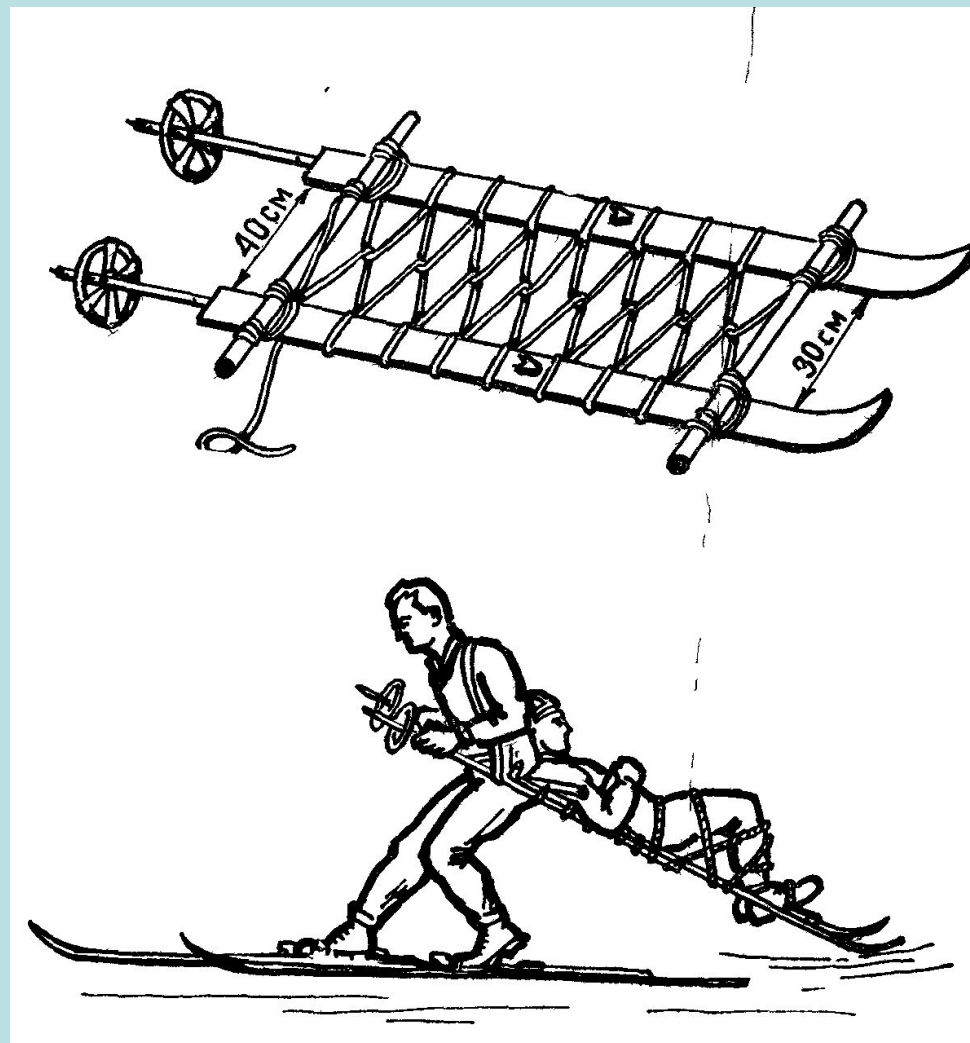
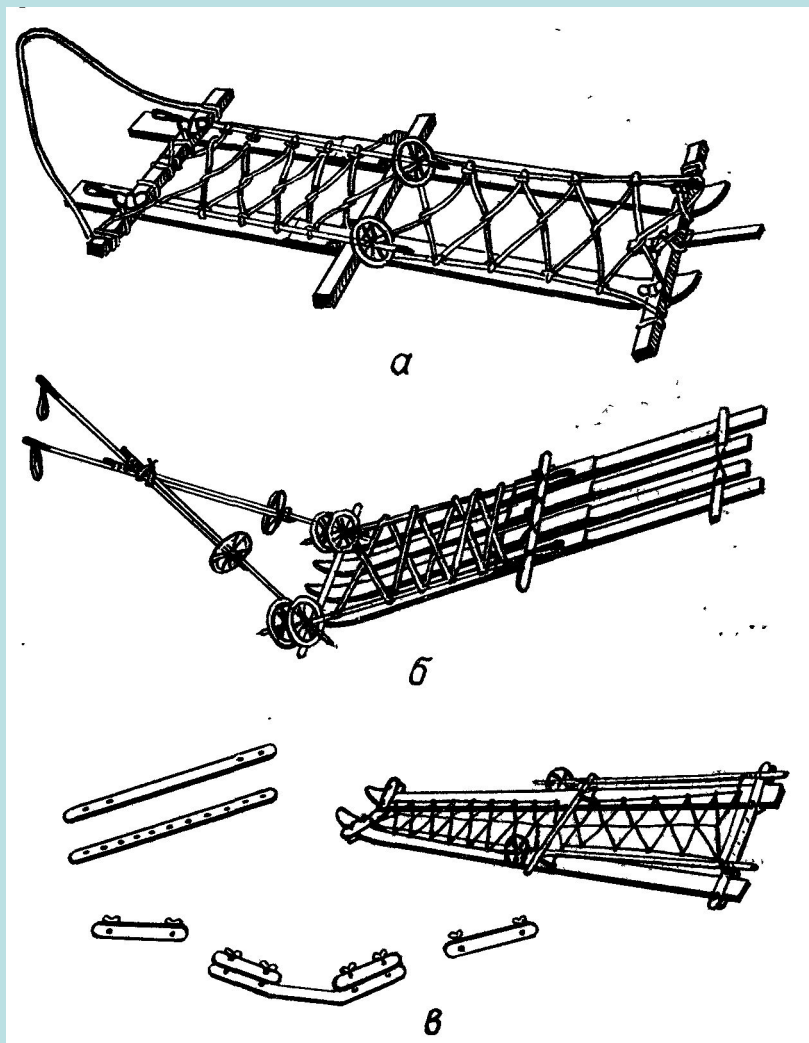



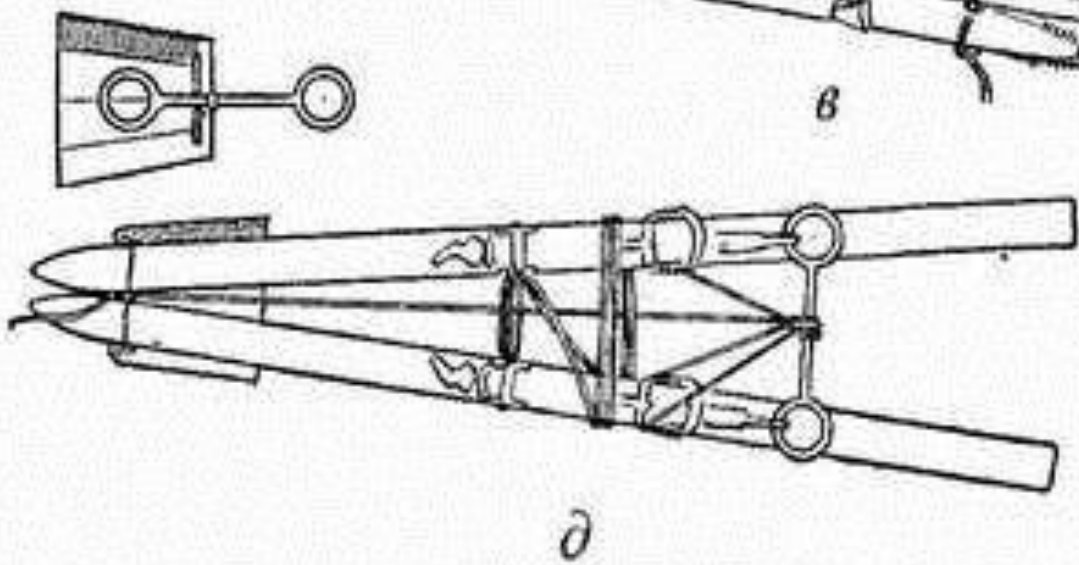
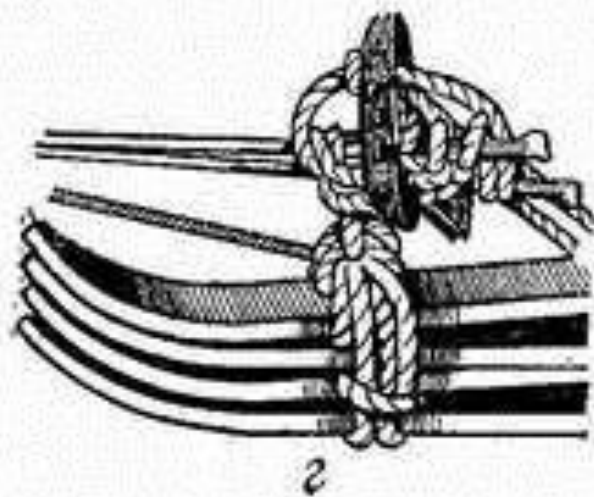
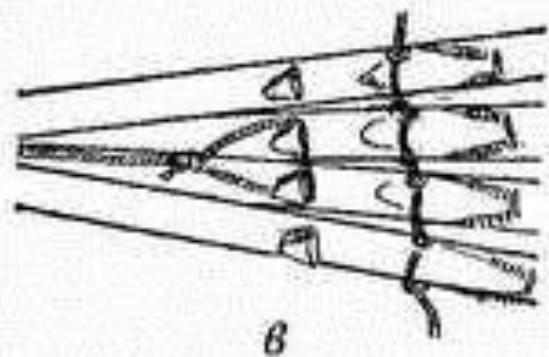
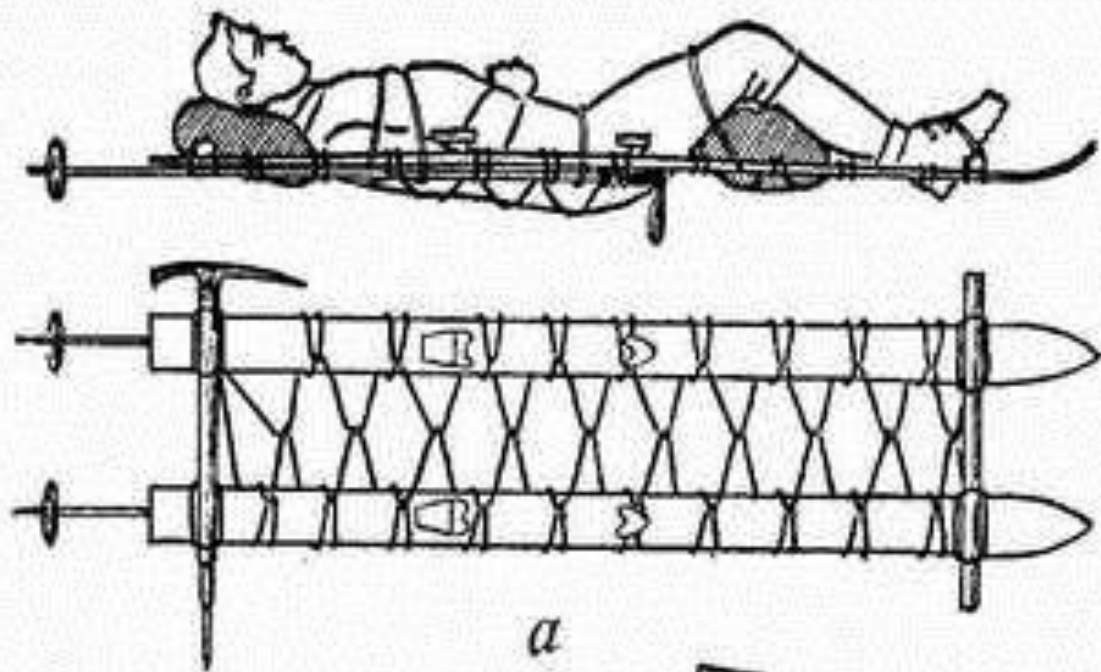

# Изготовление плетёных носилок 1 способ

<https://ok.ru/video/321161794014>

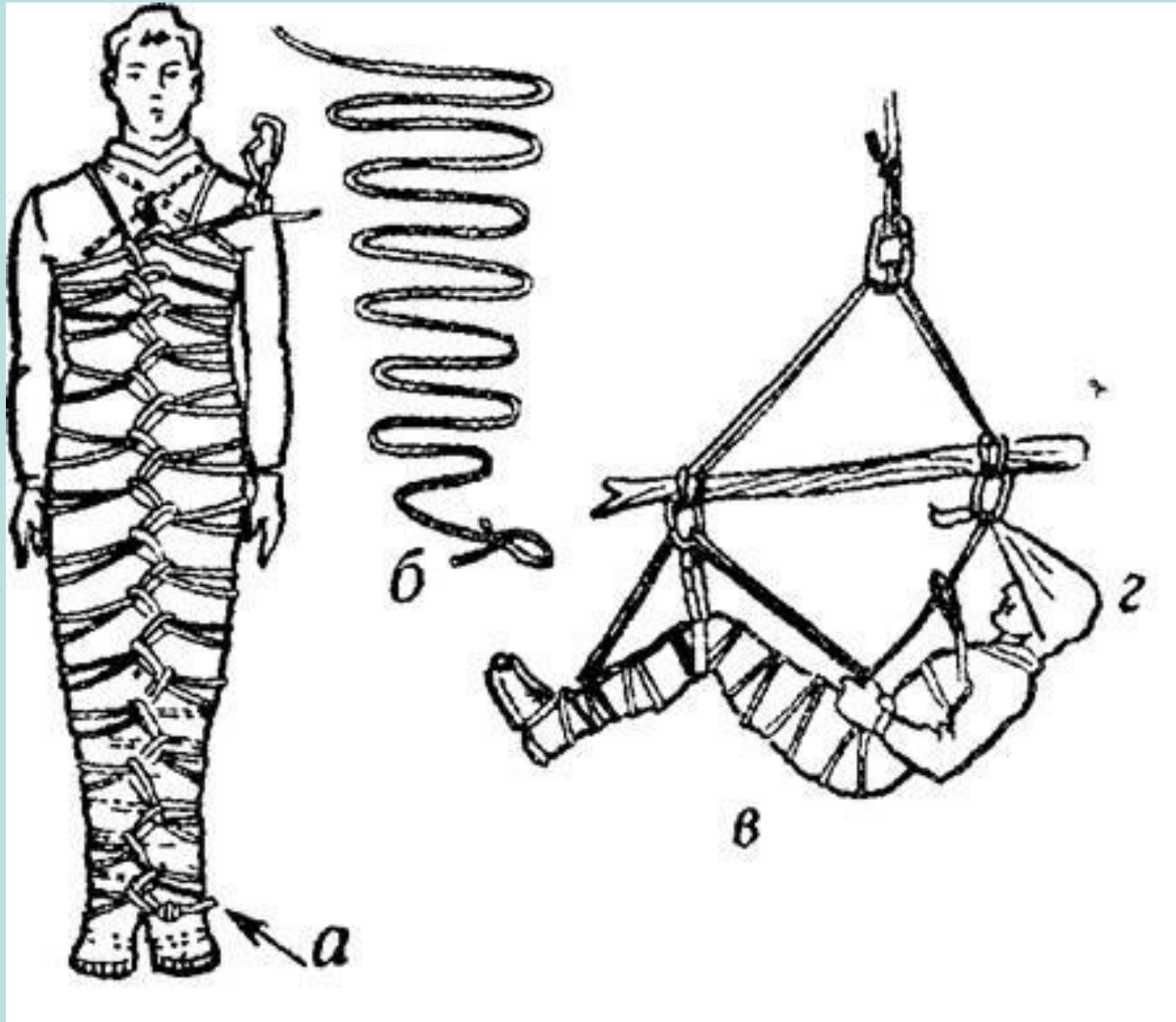





































## 2 способ

<https://youtu.be/hpVRvYzVTBw>





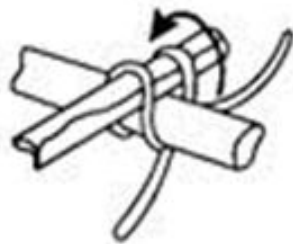

*Вязка узлов соединения шестов с перекладинами*



































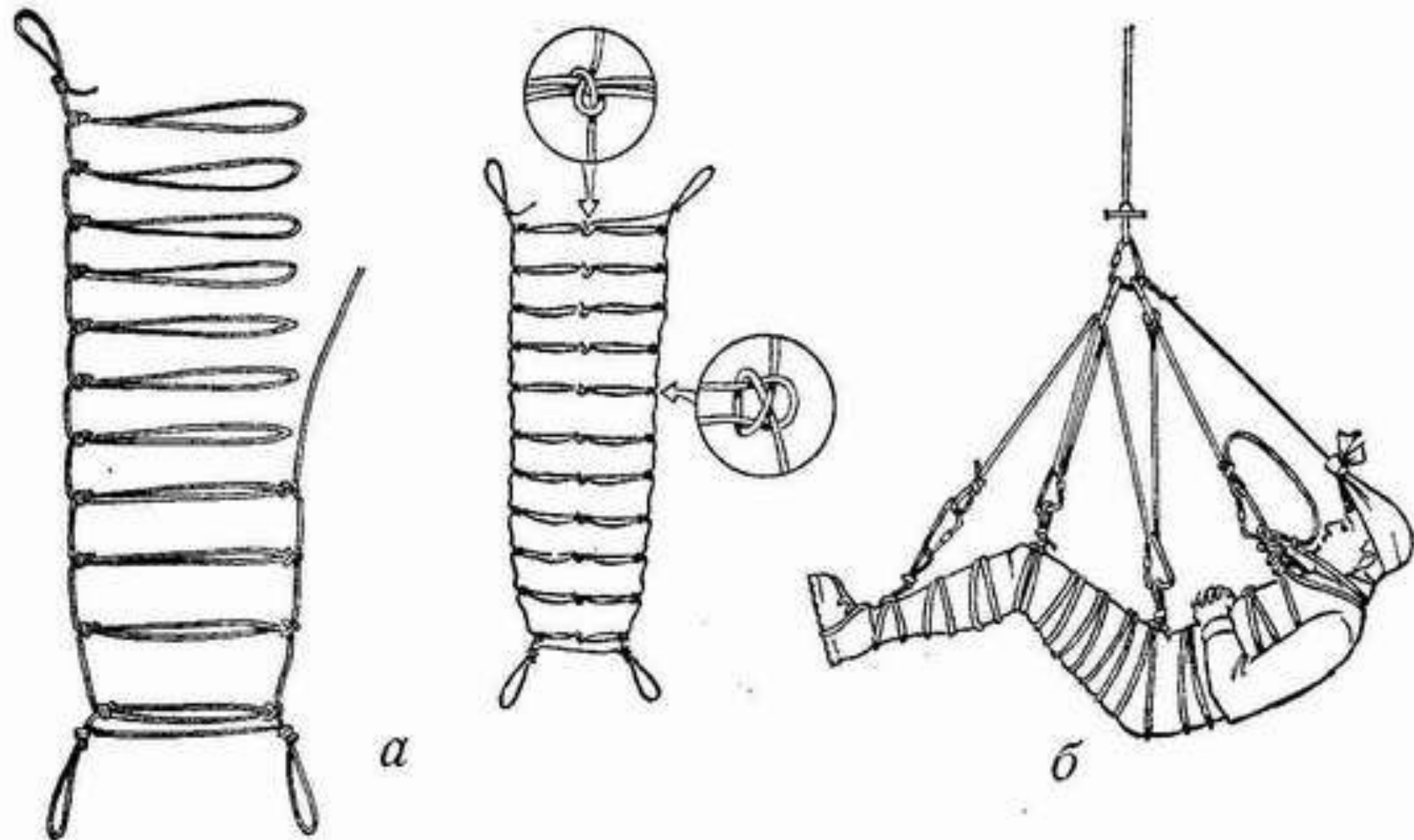

Носилки из веревок

## 4 способ

<http://obg-19.narod.ru/videoturizm/medicina/transppost.mp4>















































## 5 способ



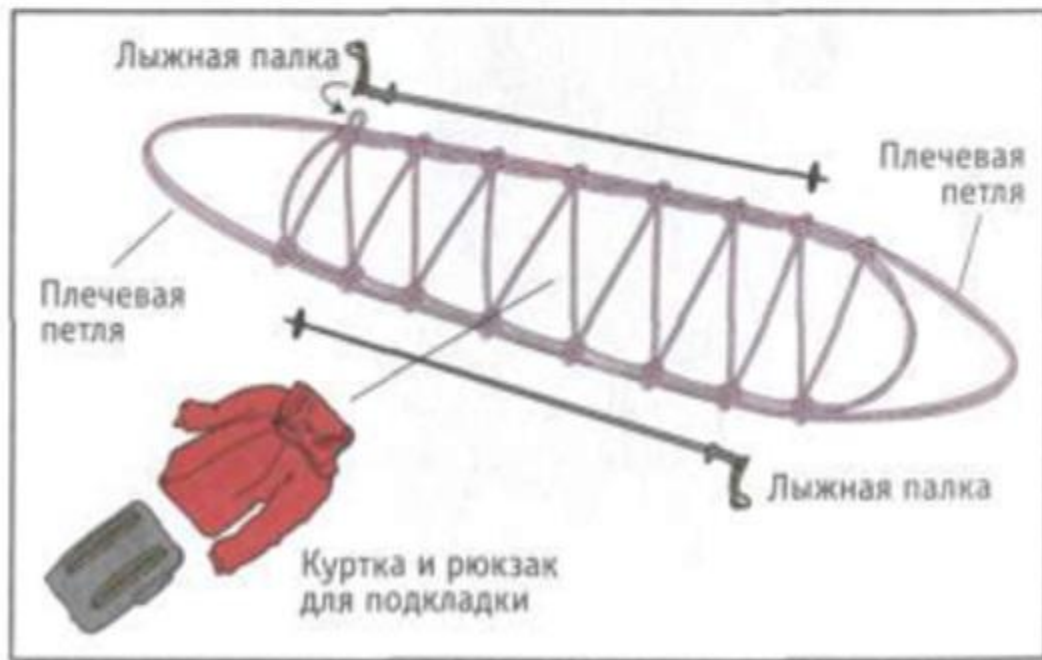
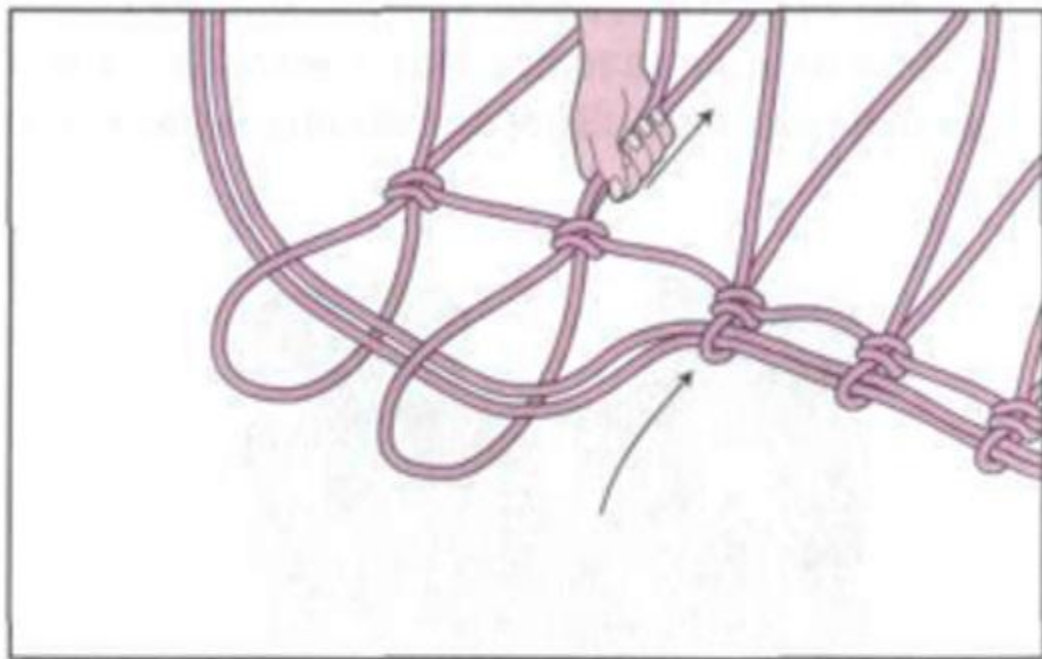



## Использование носилок при переправе



