

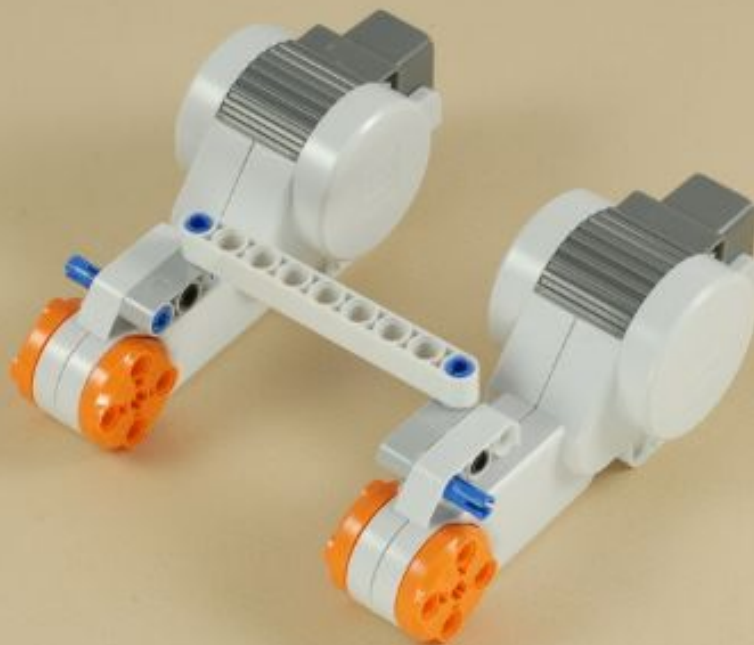

1



2





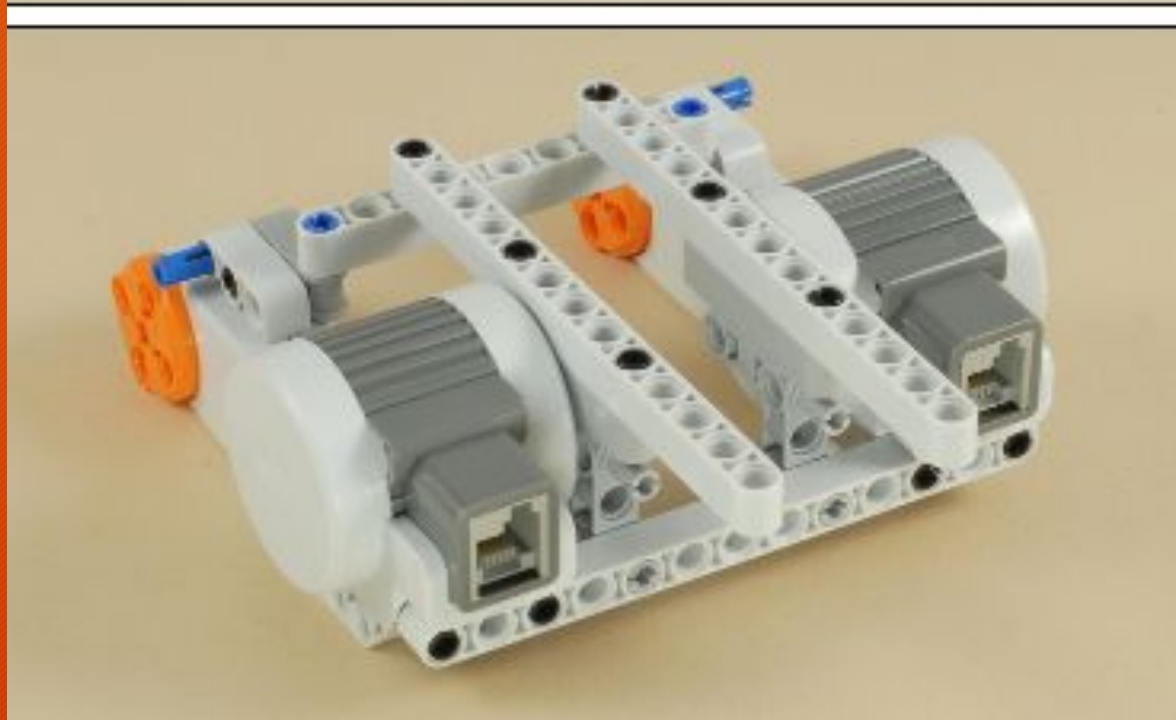

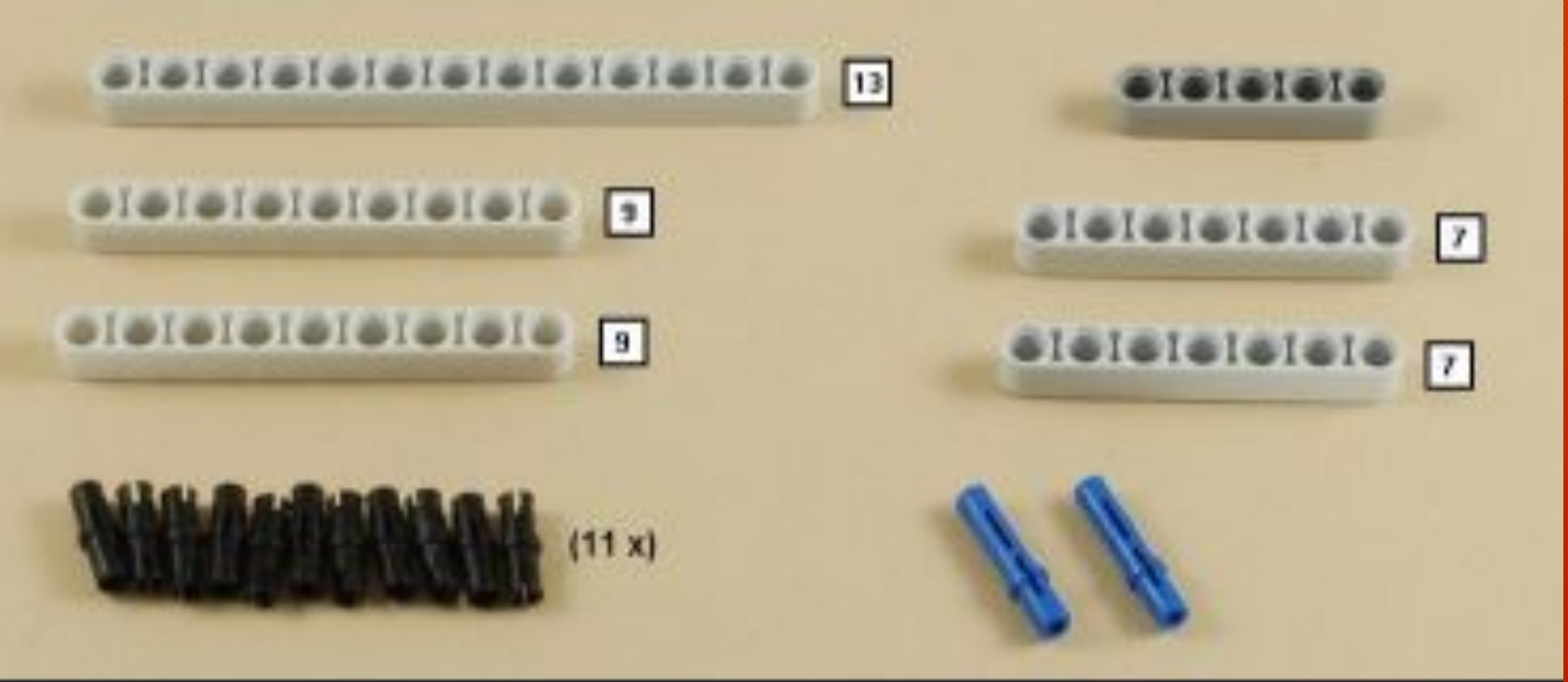

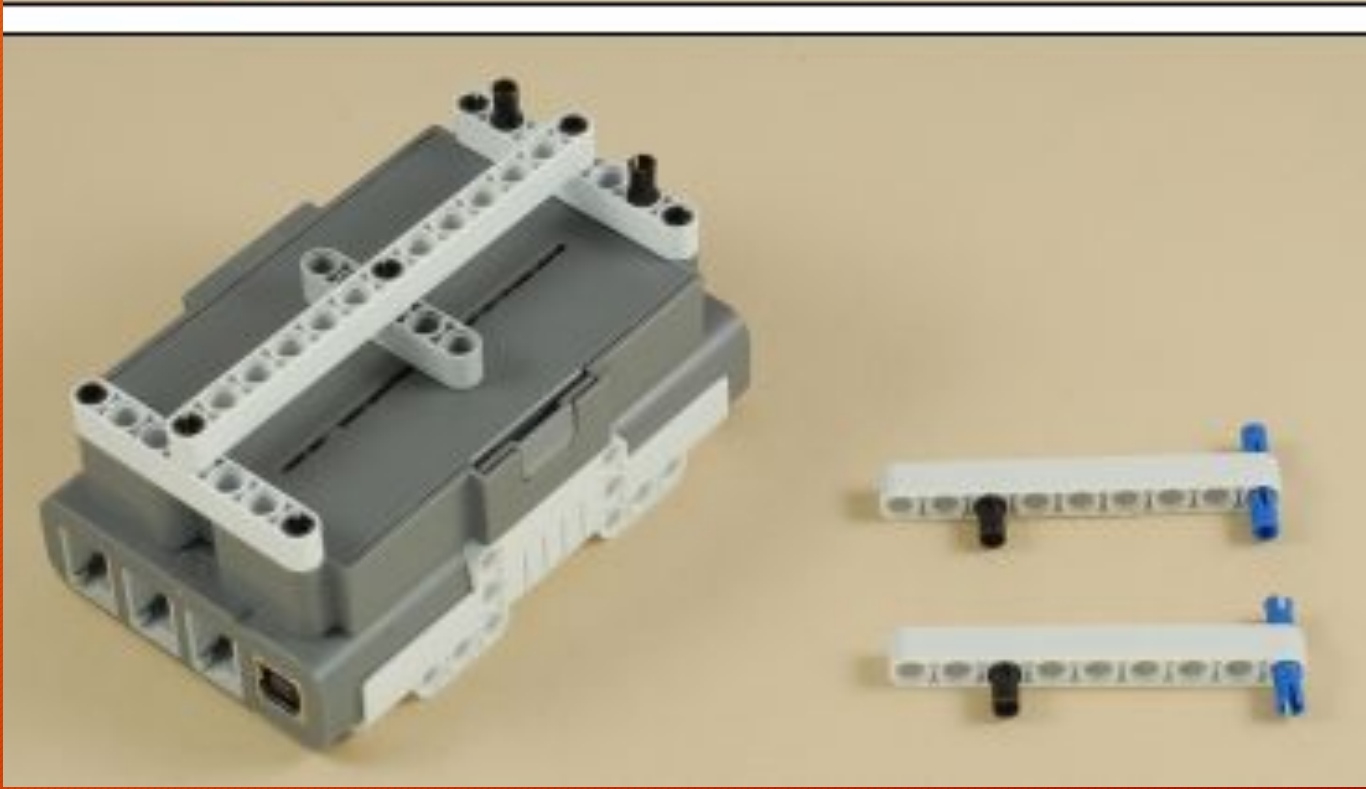

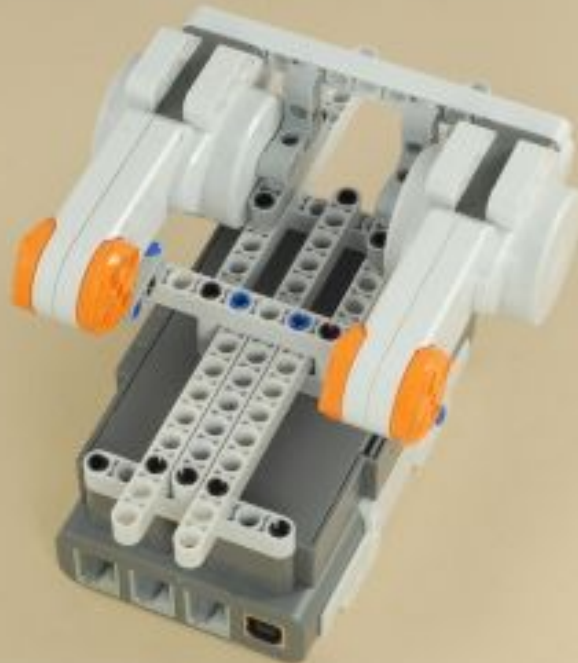

7

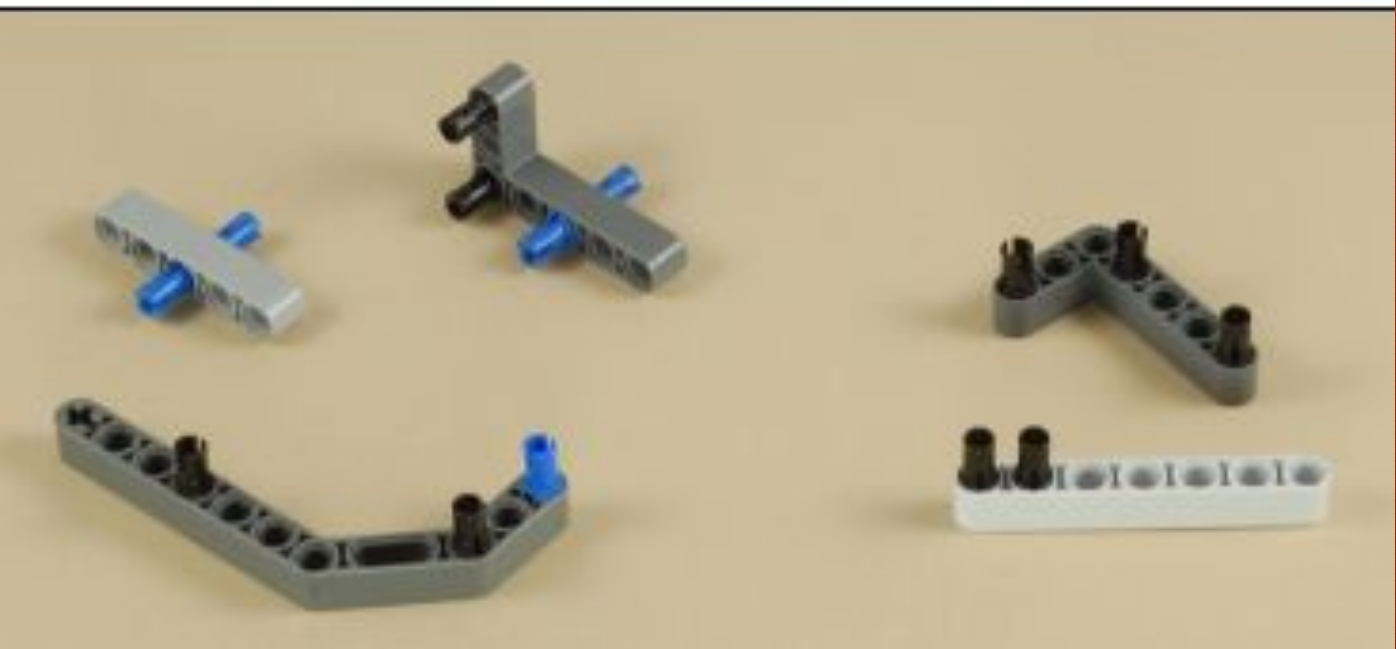
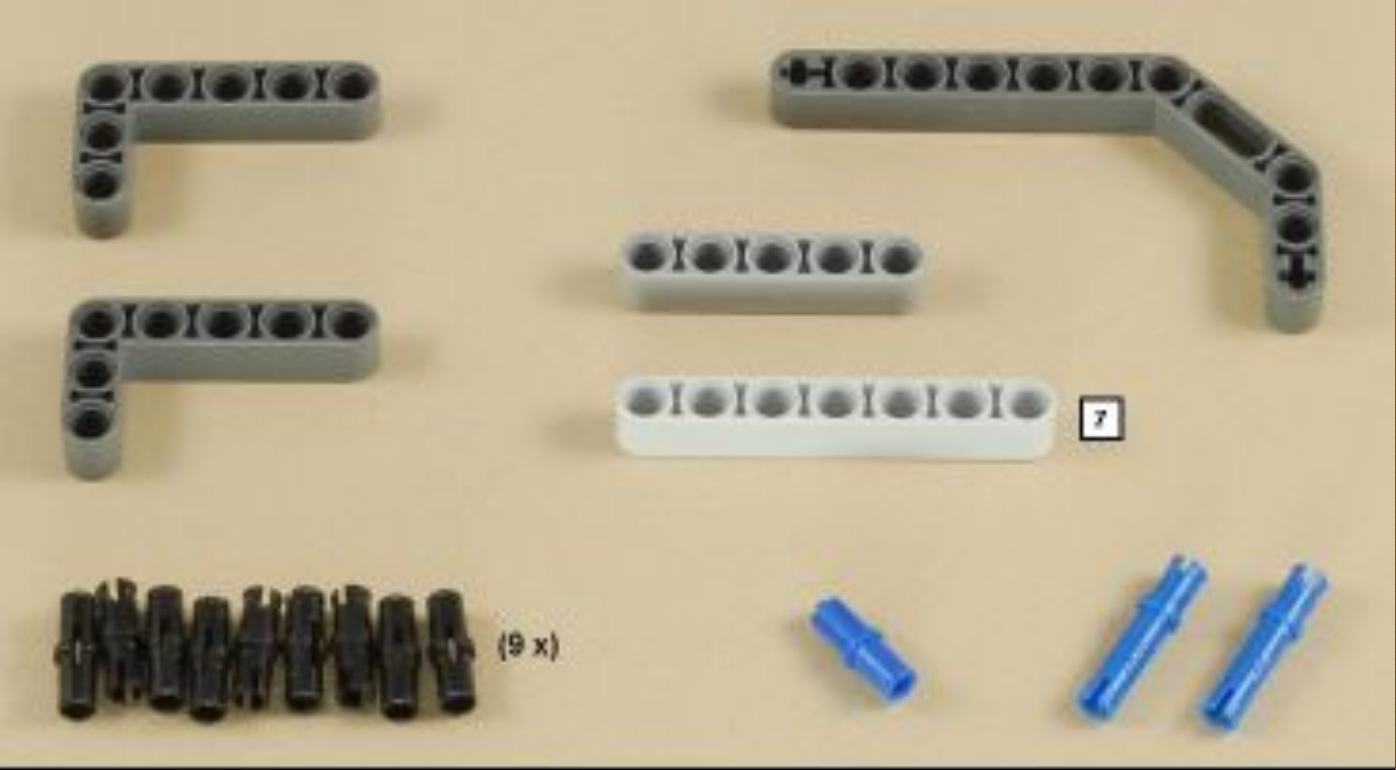

9



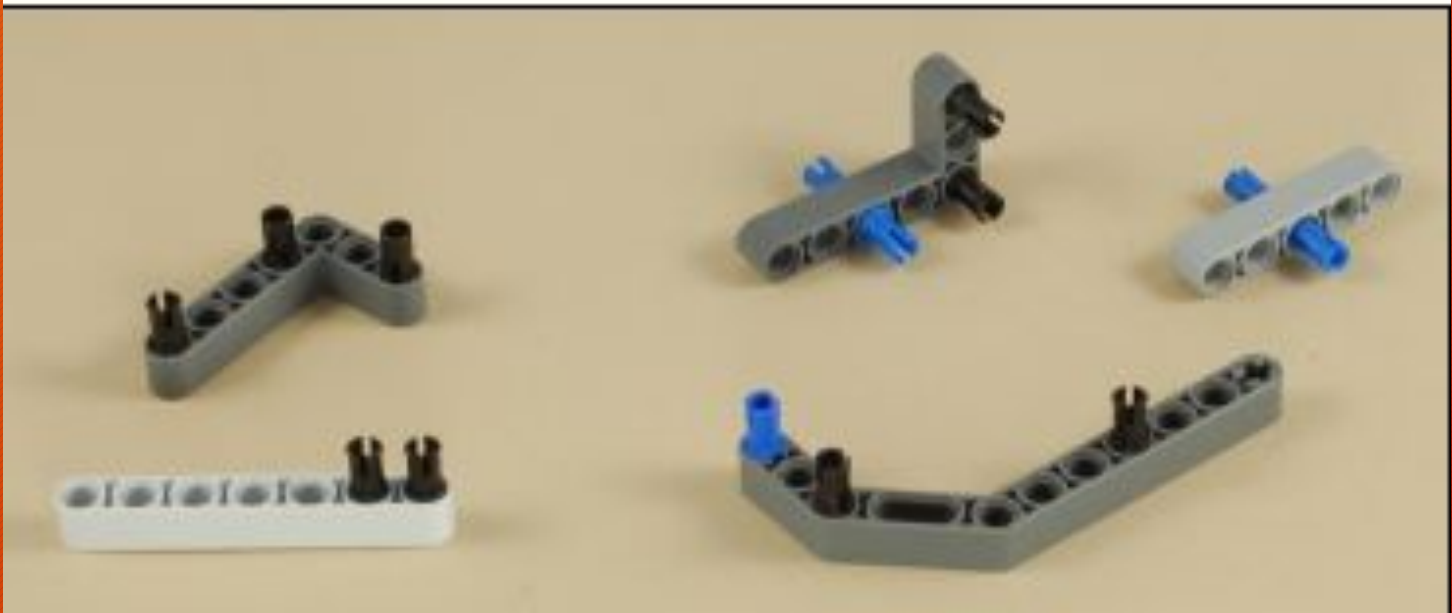
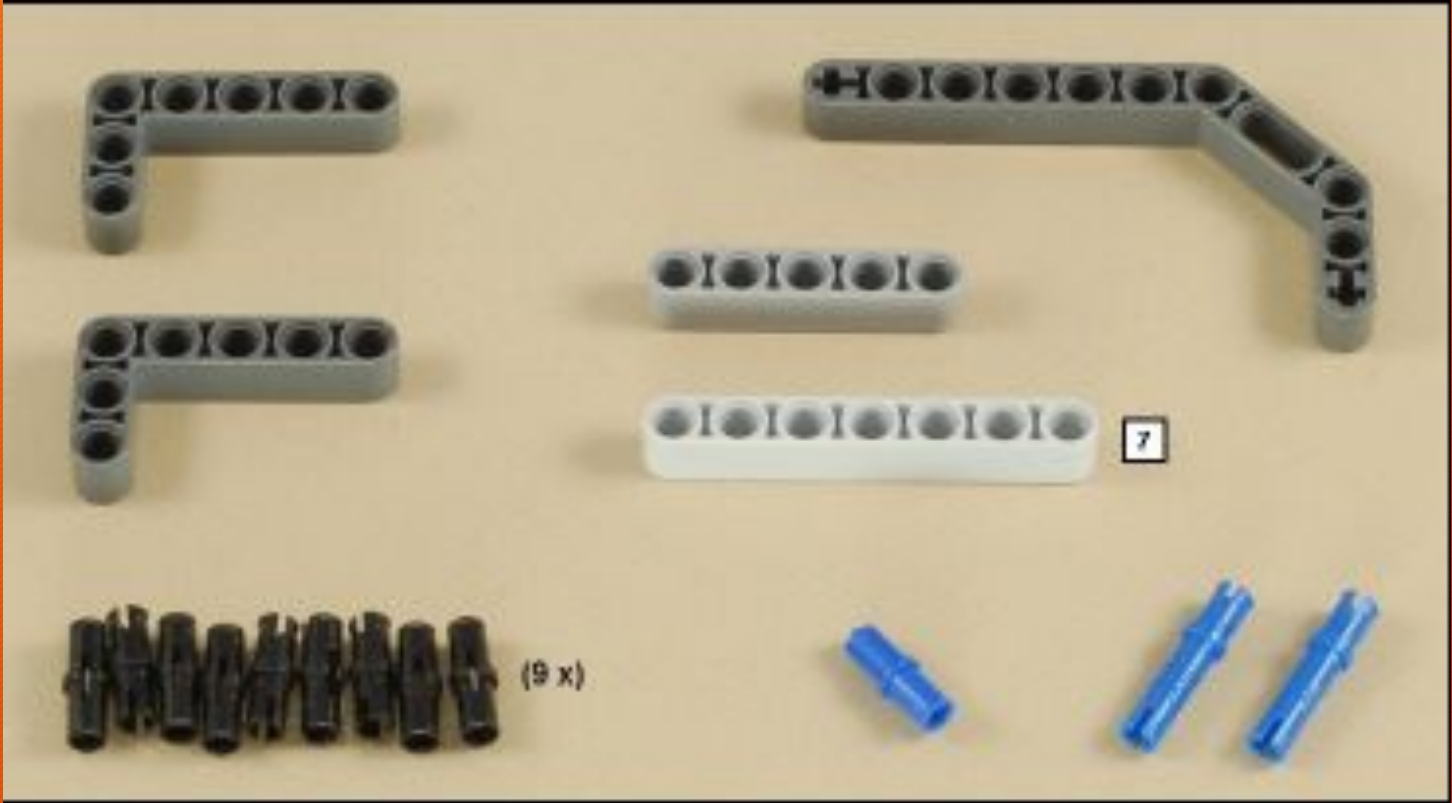



1

1

12

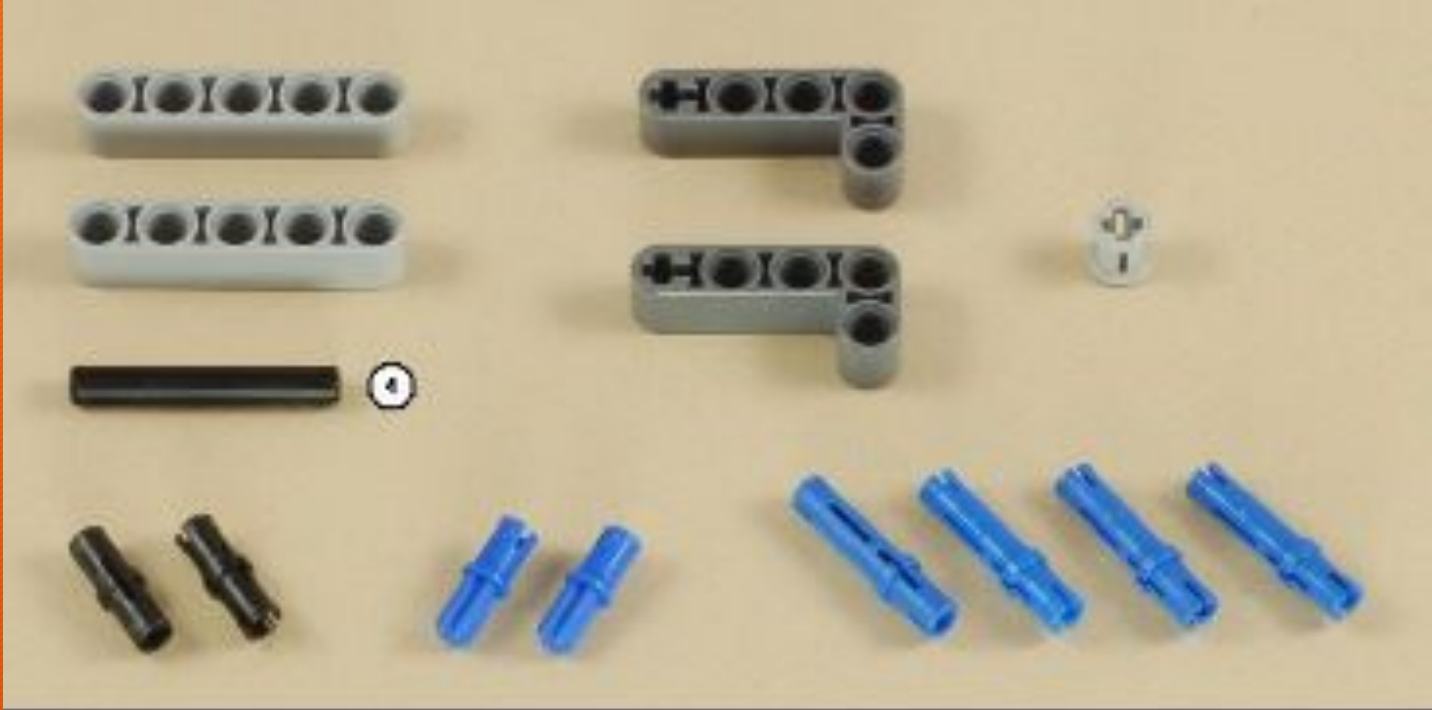

13

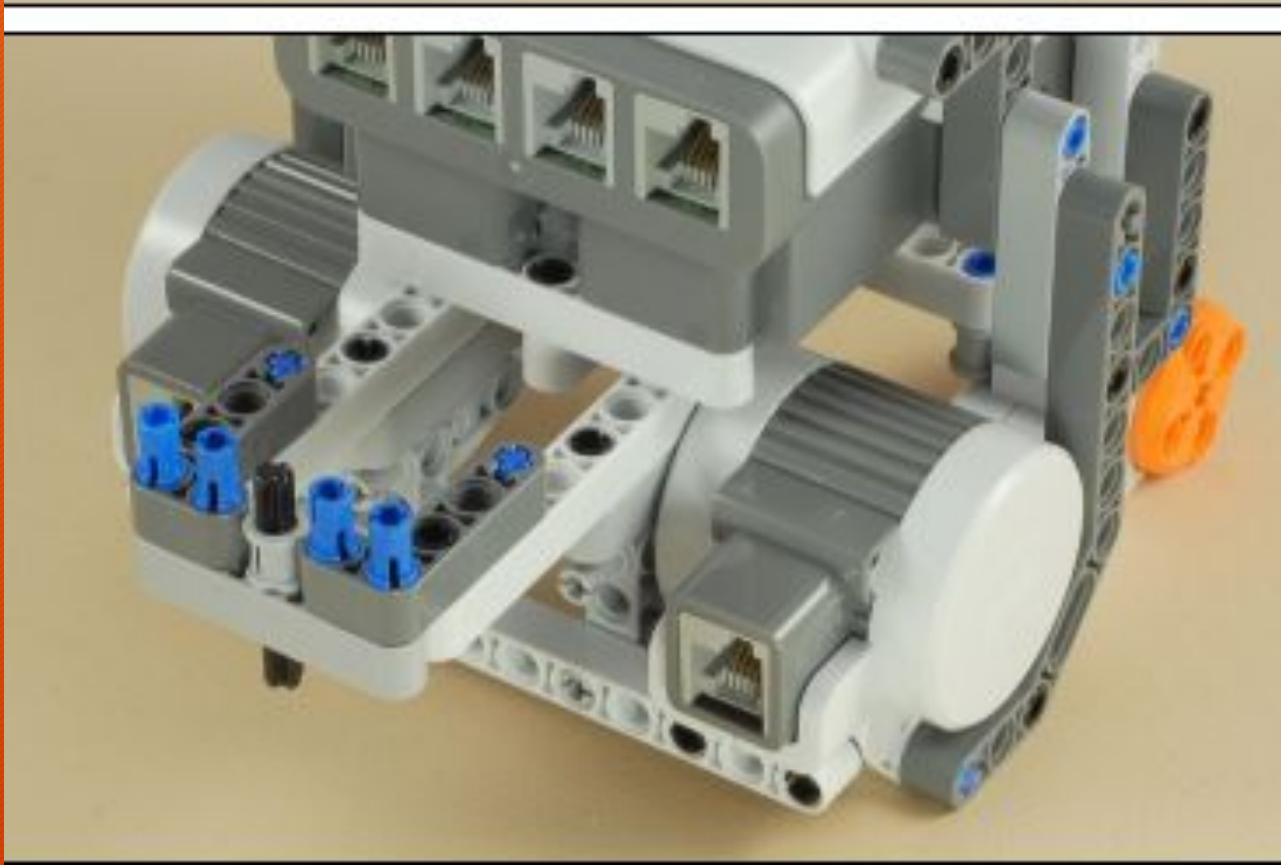
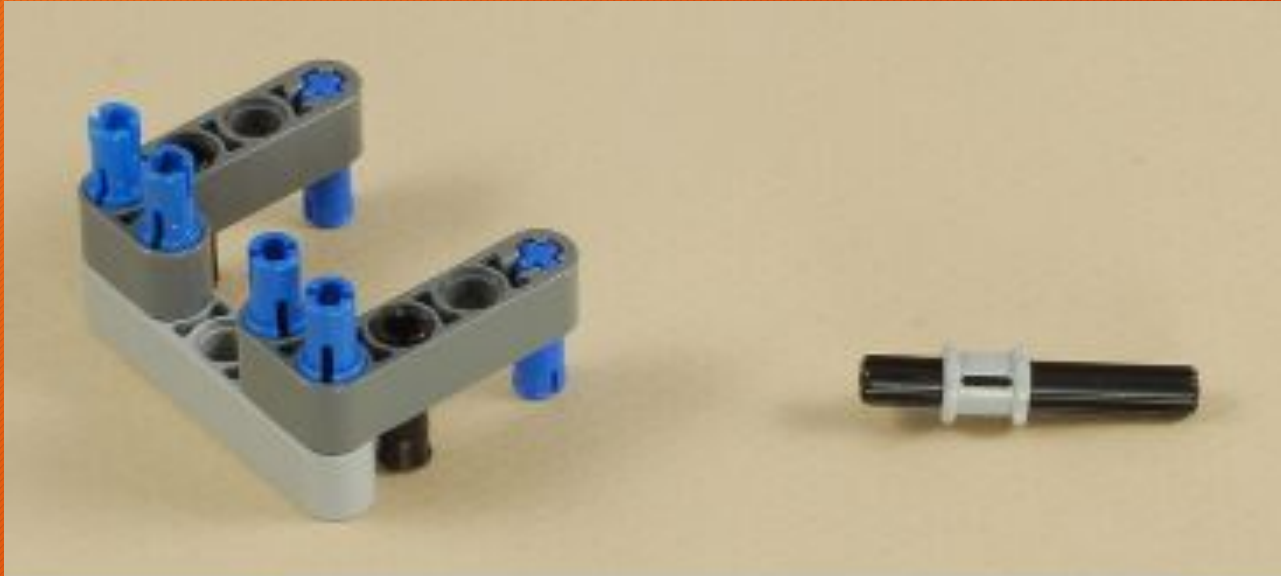

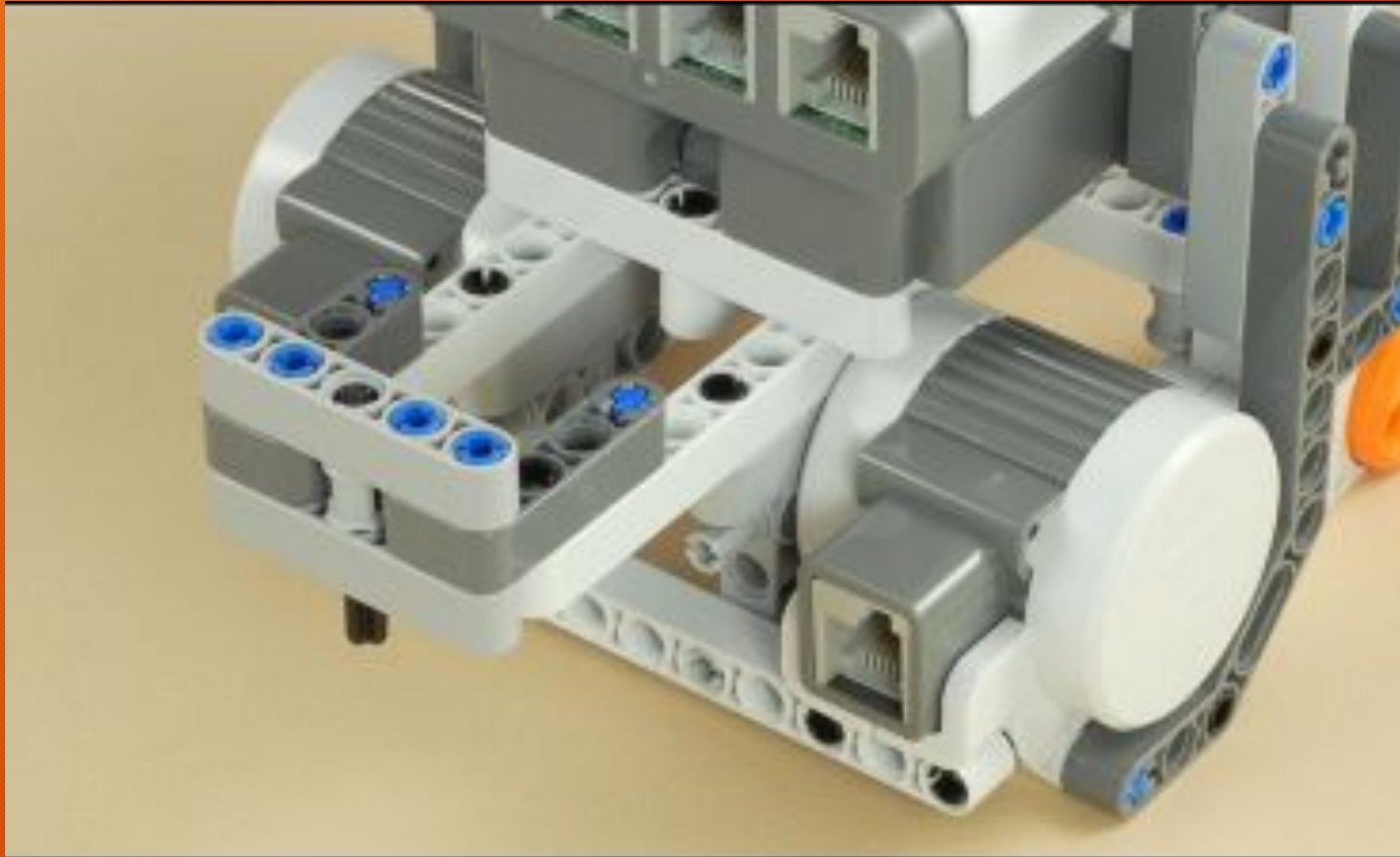





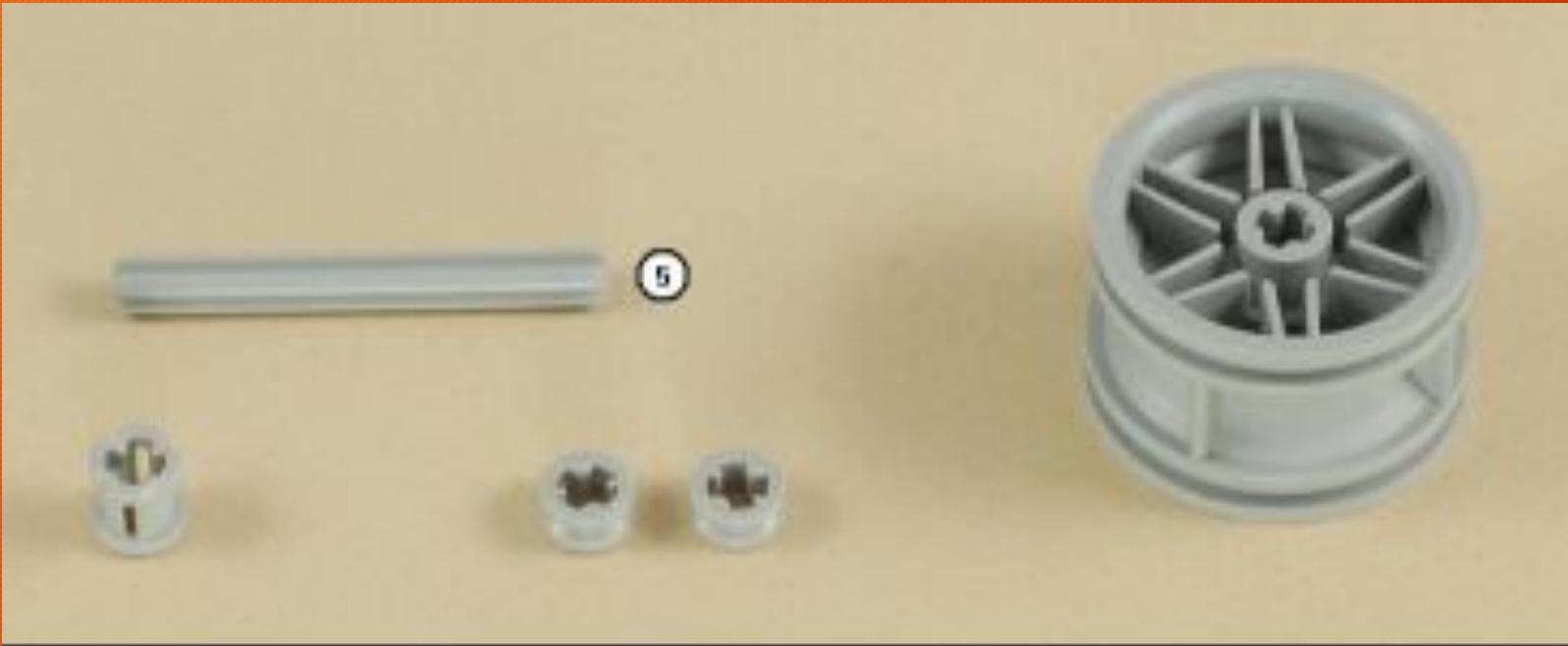





20

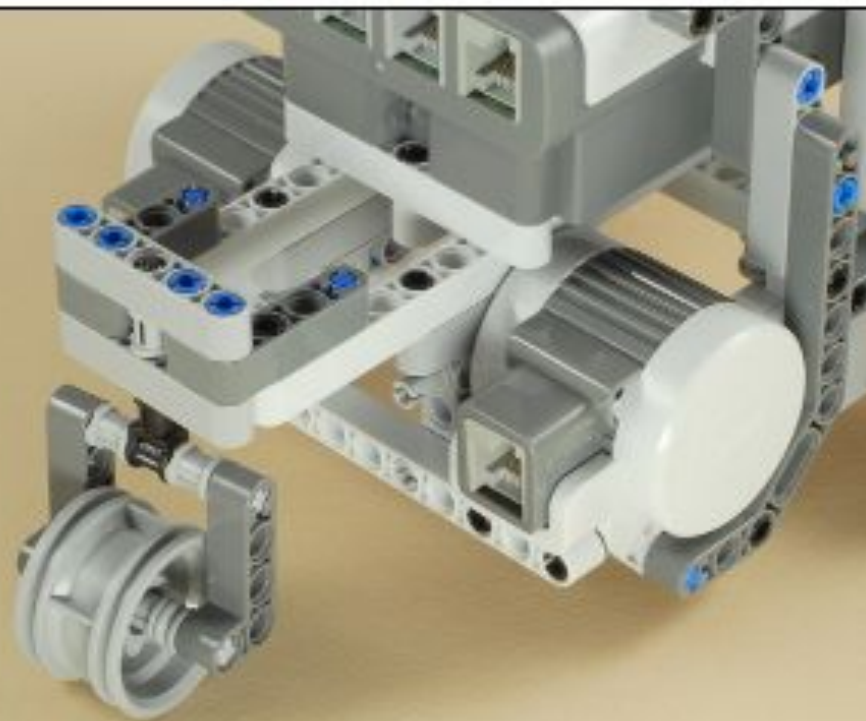





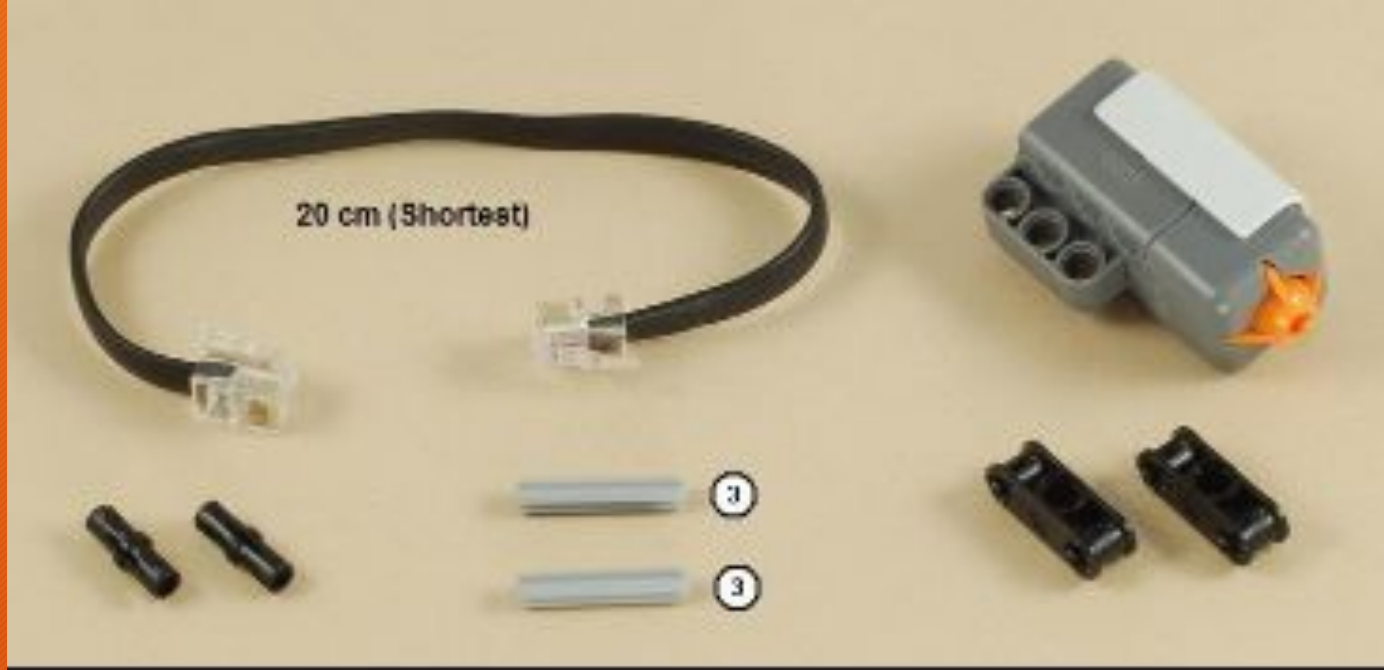



Присоедините кабель от датчик наклона в порт № 1 блока NXT.









27

3-Li

(ТОЛЬКО при использовании литиевого аккумуляторного блока)

