

Урок 1

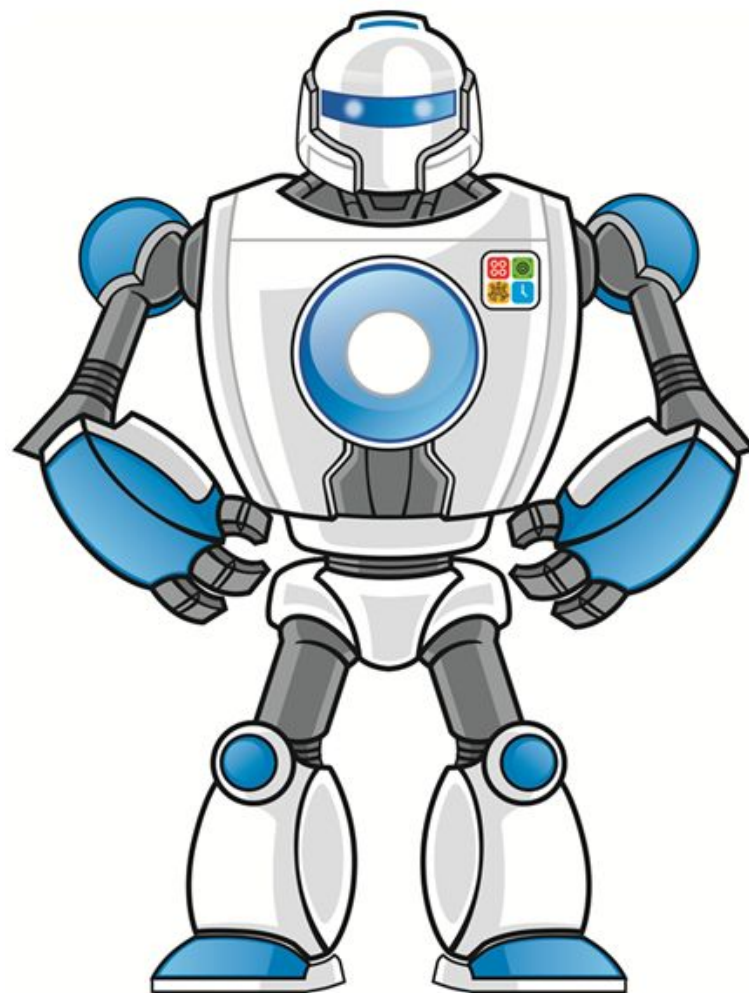

1

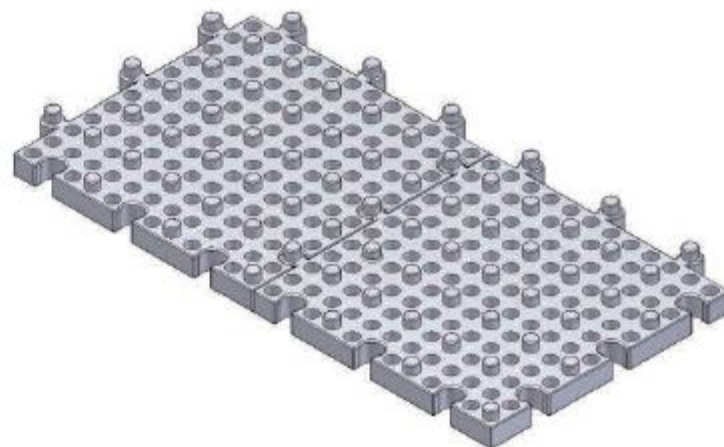
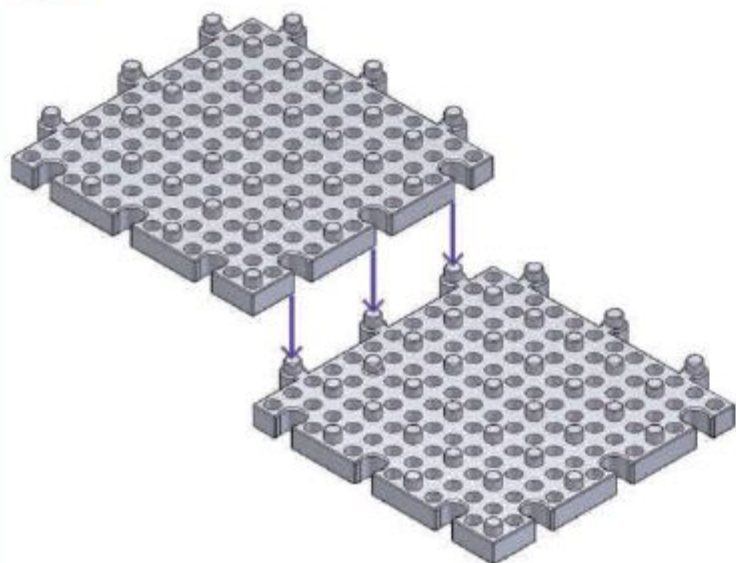

2

2

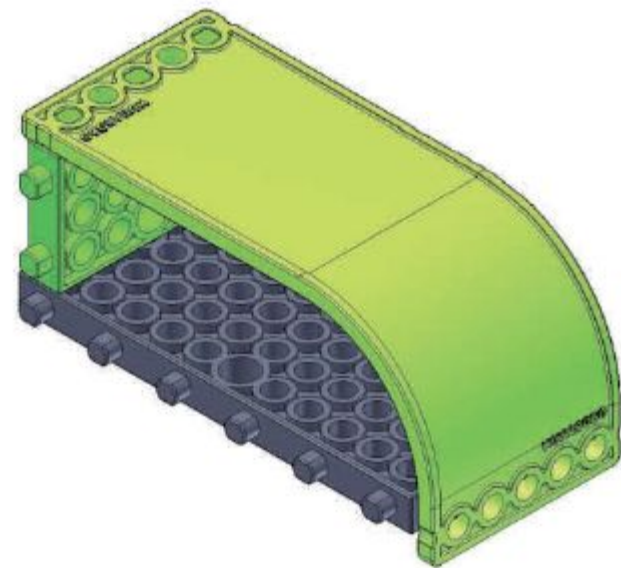
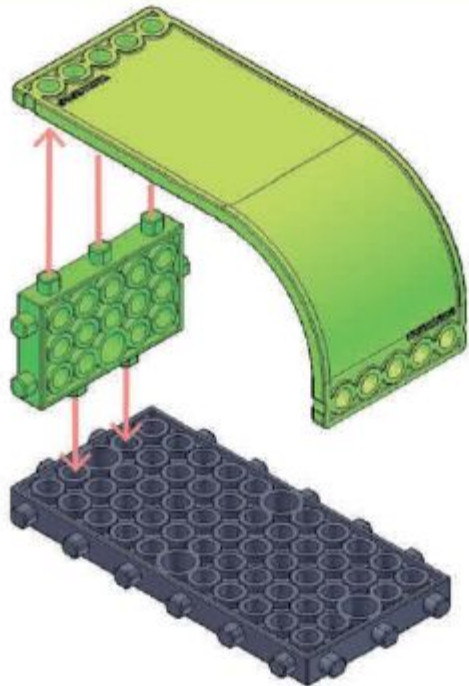

3

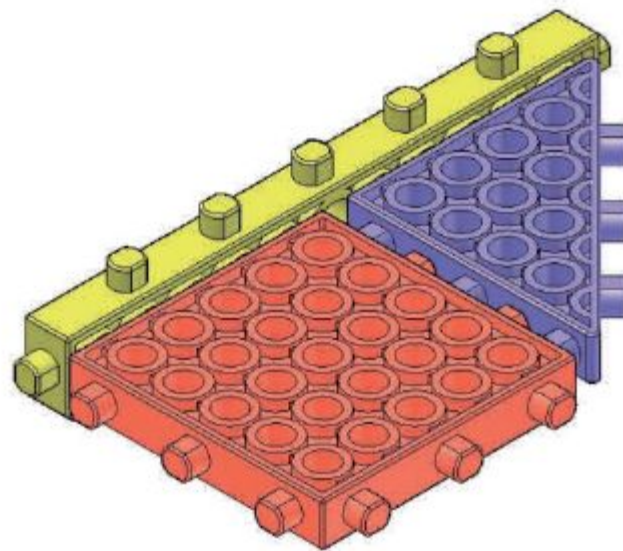
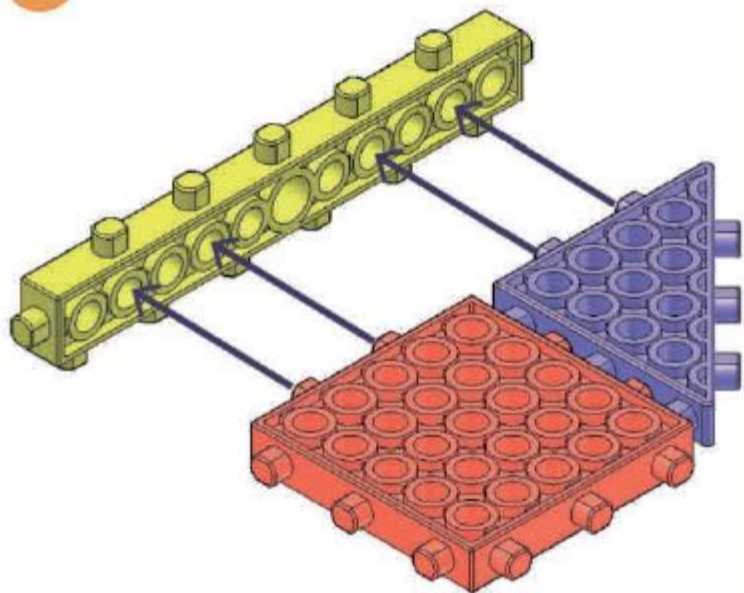

4

4

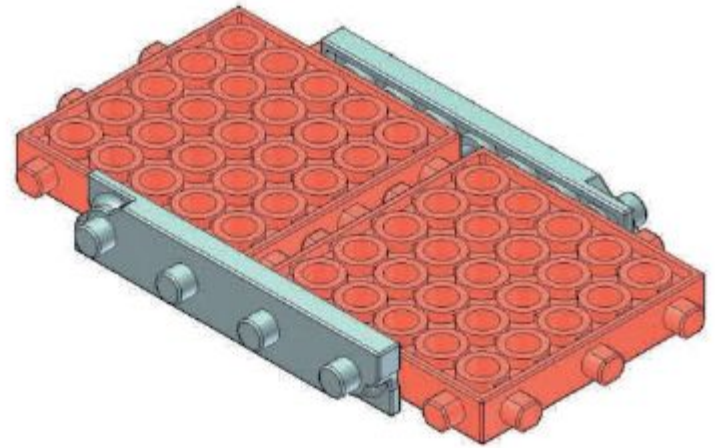
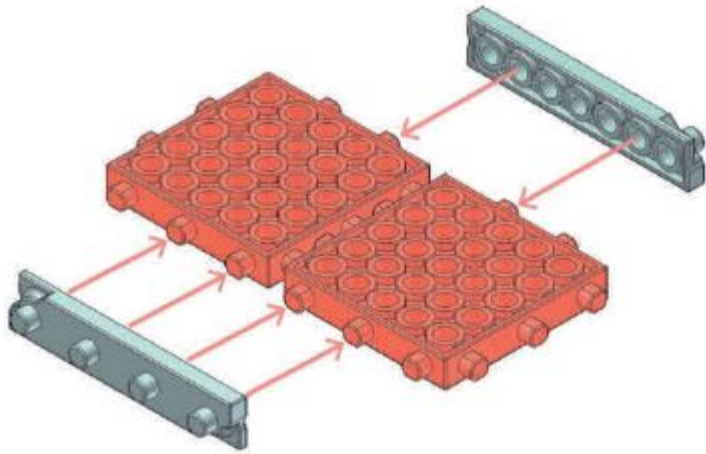

5

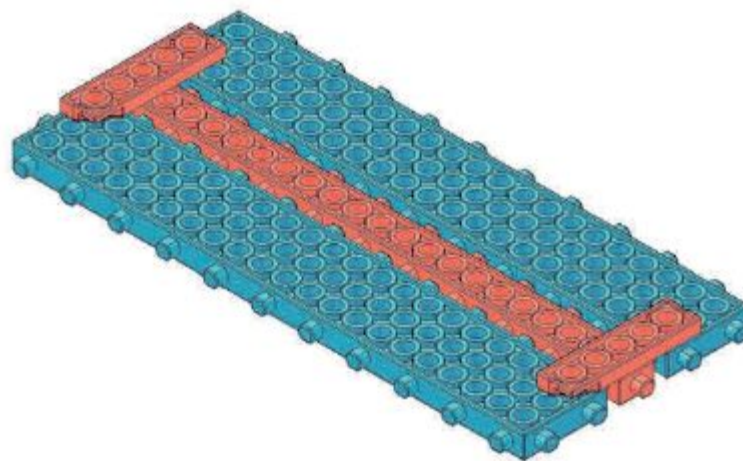
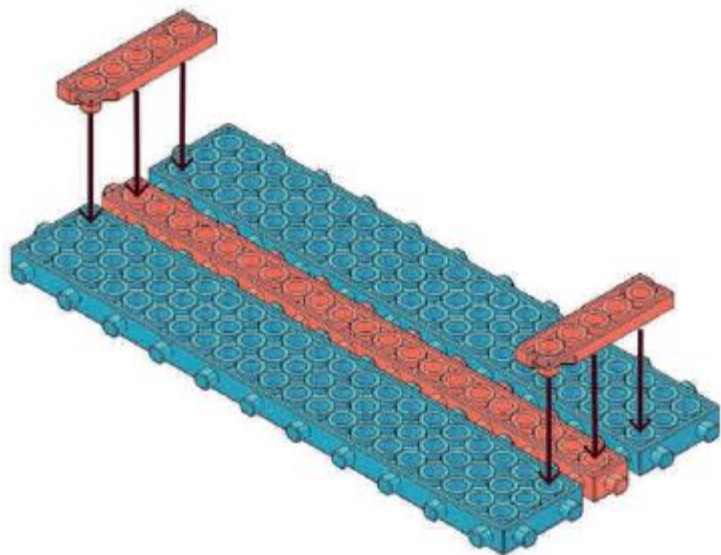

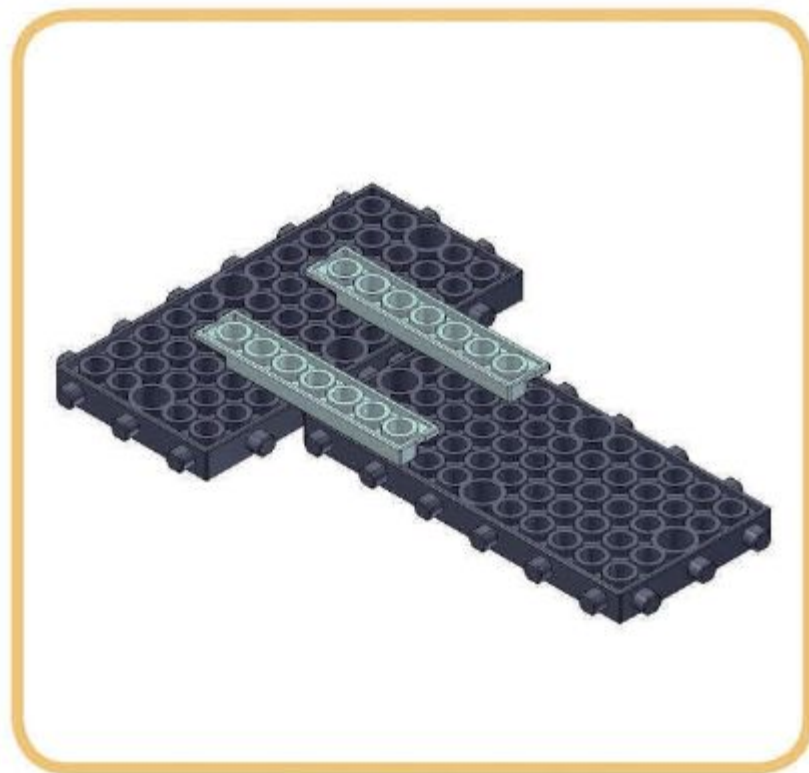
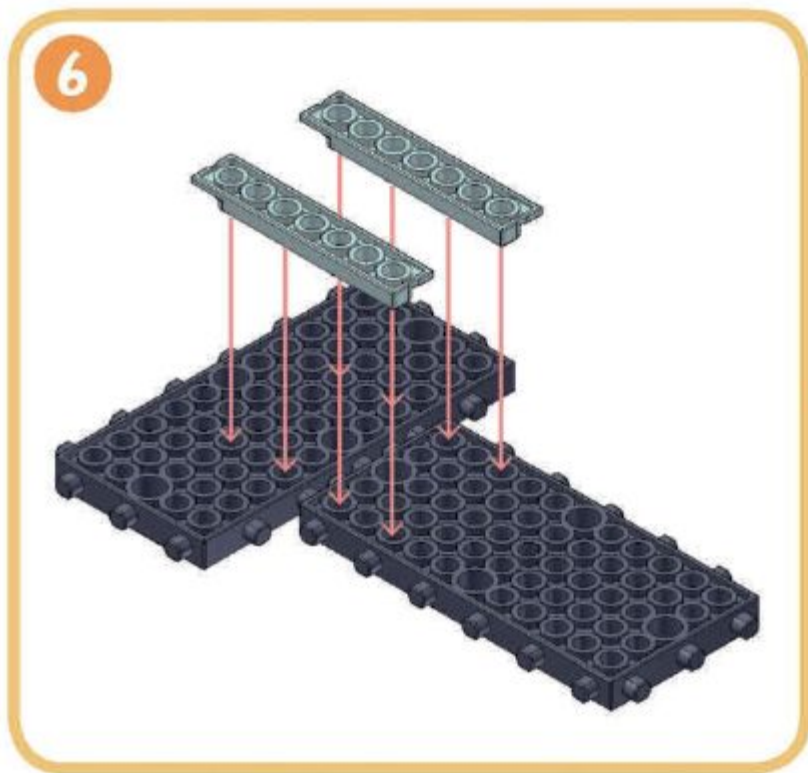



Соединяем вал и втулку

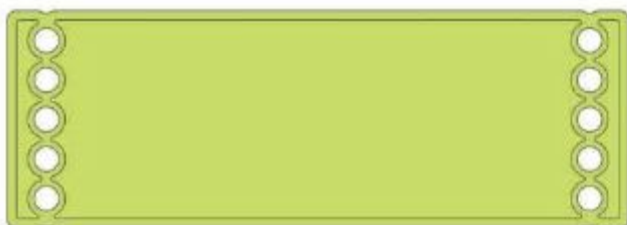

Рамка 5 (5 отверстий)



Рамка 11 (11 отверстий)



Рамка 21

(21 отверстие)

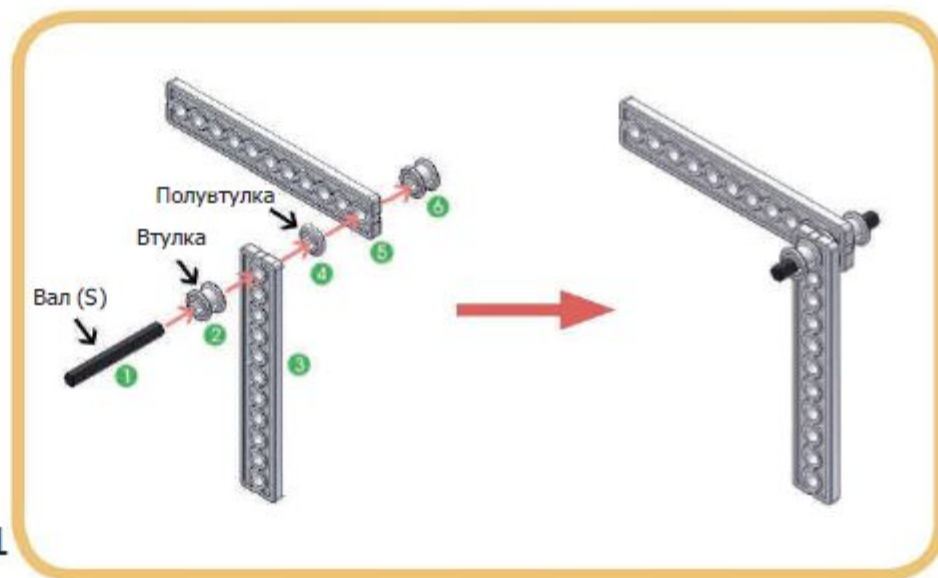



Соединяем вал и муфту



Соединительный вал



Вал (S) (малый)



Вал (M) (средний)



Вал (L) (большой)



Красная
втулка



Втулка

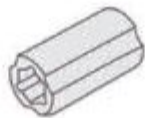

Муфта



Полувтулка

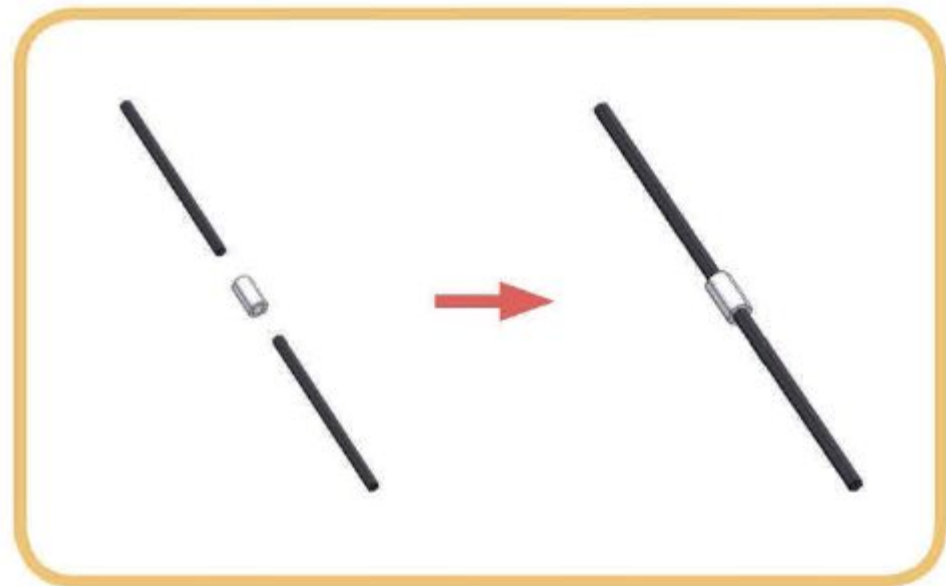



Размеры шестерёнок (зубчатых колёс)



Шестеренка (S)
(малая)



Шестеренка (M)
(средняя)

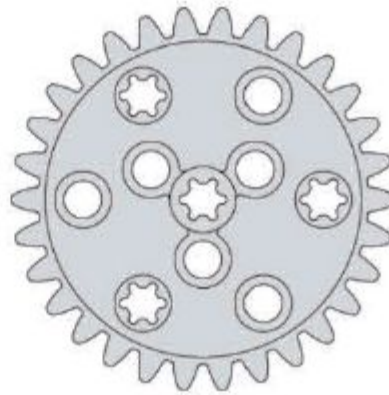

Шестеренка (L)
(большая)



Электронные детали



Материнская плата
базового уровня



Электродвигатель



Аккумуляторная коробка



Давайте сделаем стул



Сколько ножек бывает у стульев?

Какие стулья самые устойчивые?

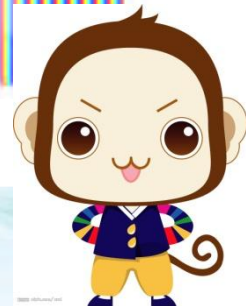
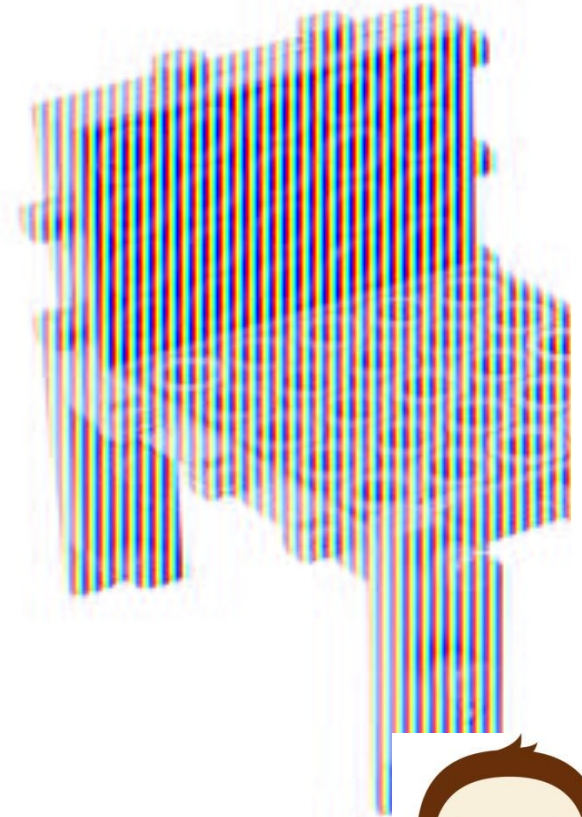



Начинаем сборку!

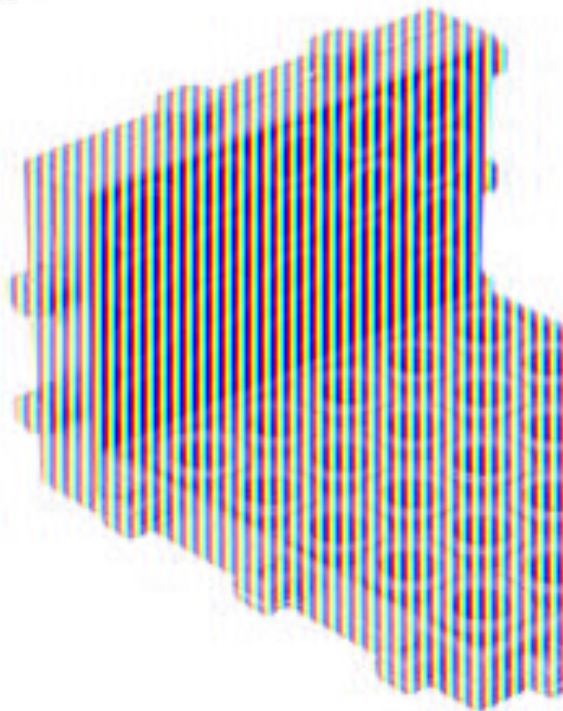

Соедините два квадратных блока 55



Сделайте две задних ножки из соединительных блоков!





Почти готово!

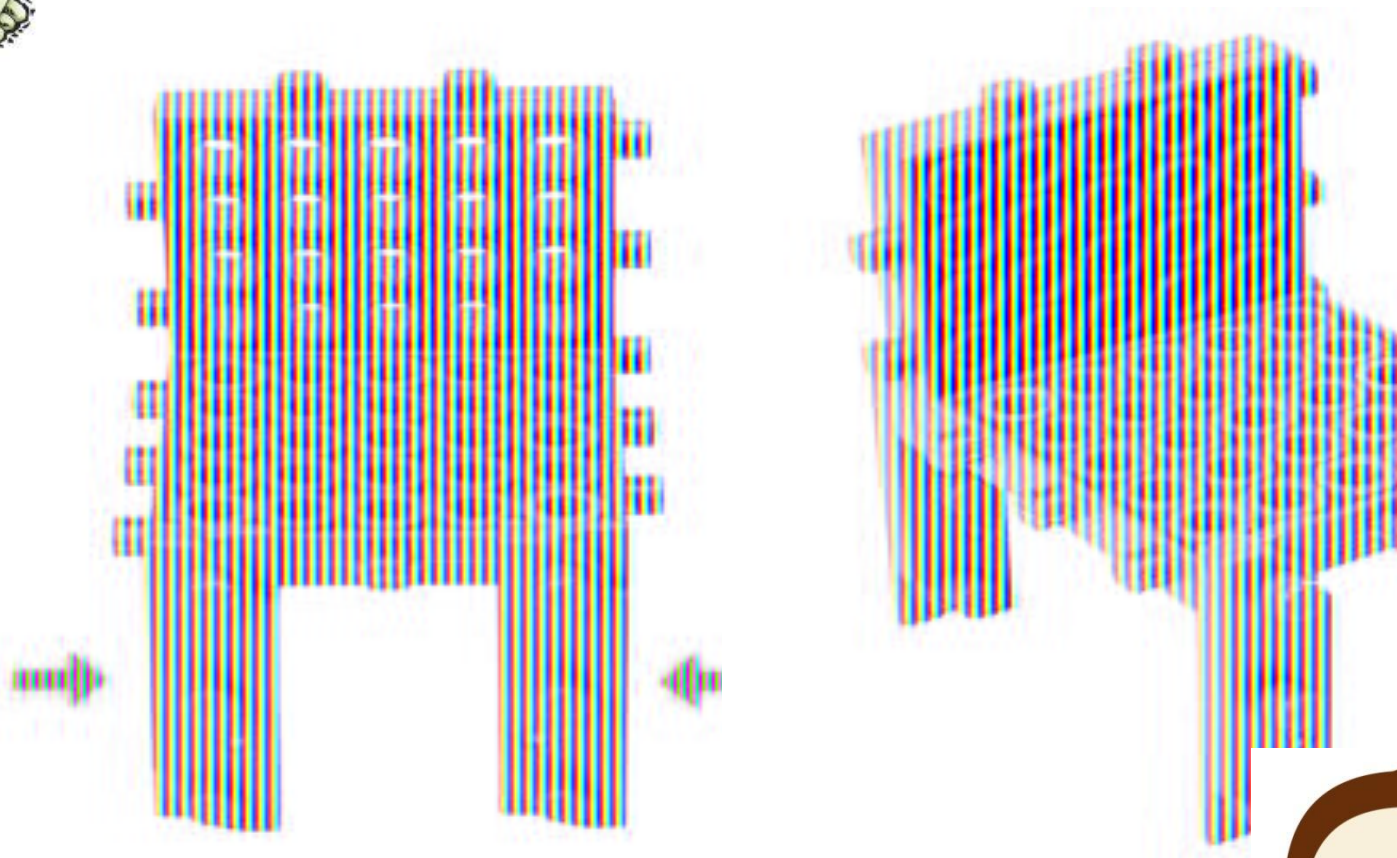

Присоединяем передние ножки.

Стул готов!

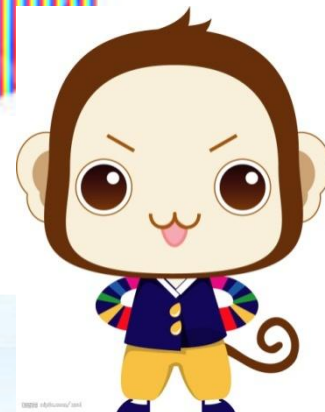



Сделаем стол!

Давайте подумаем

Что общего между стулом и
столом?

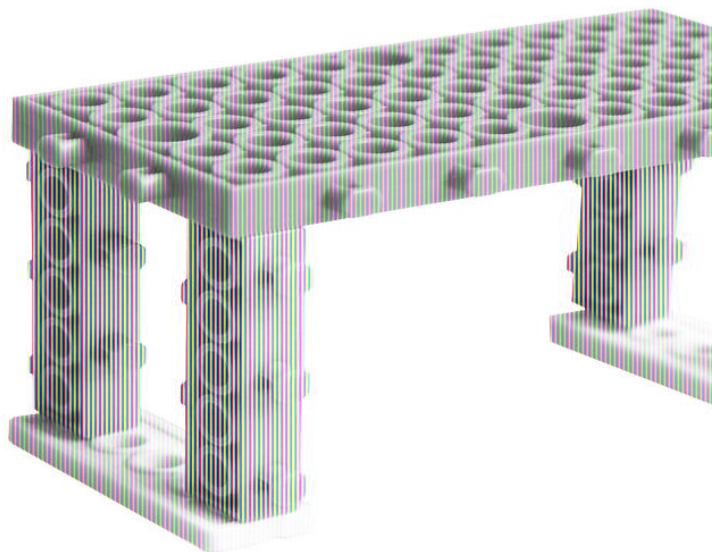



Собираем стол

Возьмите блок 5*11

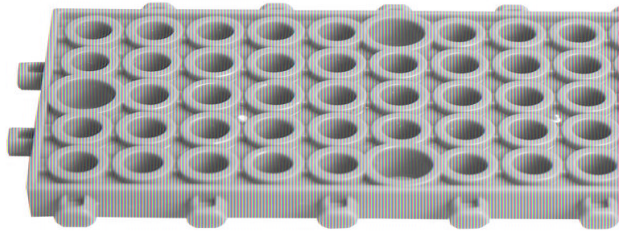

Добавим подставку из соединительного блока 5 для прочности

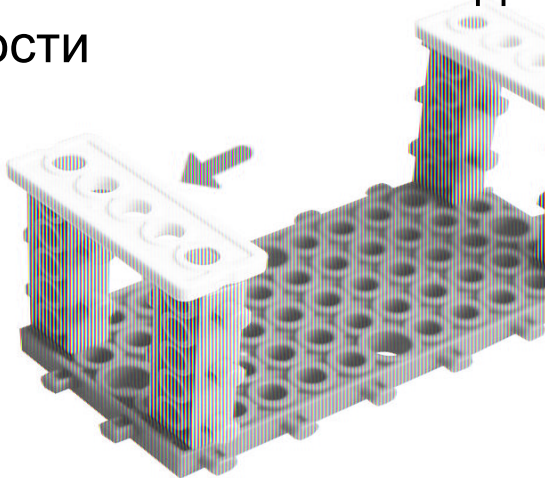

Сделайте ножки из четырех блоков 1*5

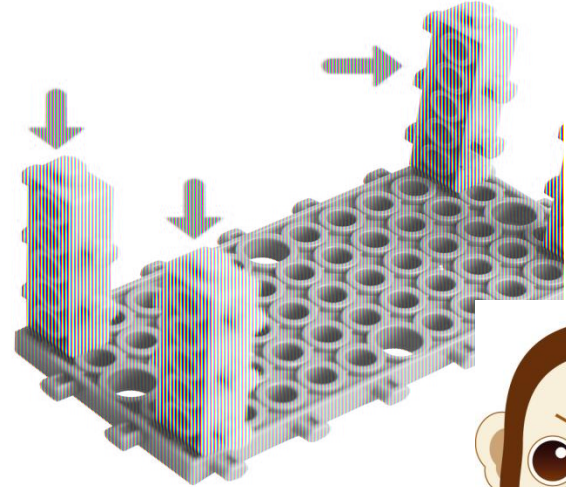

Готово!

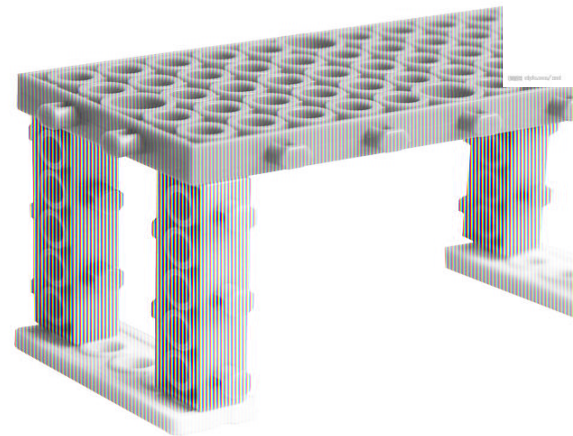

Сделаем телевизор!



Телевизор
состоит из 2
частей:

1. Экран
2. Подставка

Собираем телевизор

1

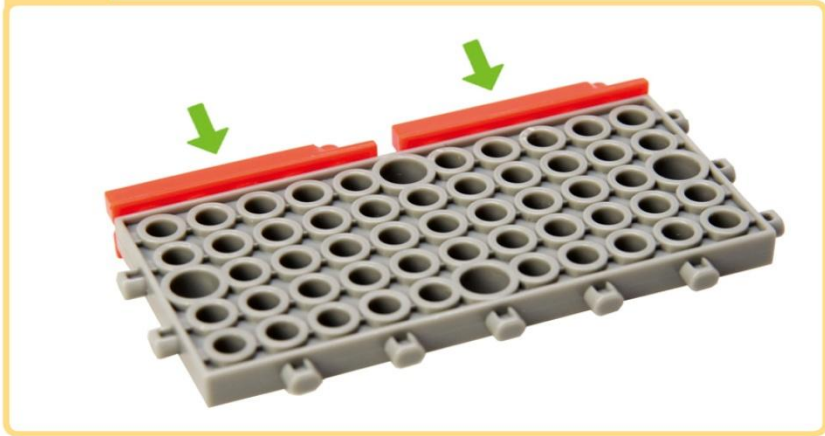

3



2



4

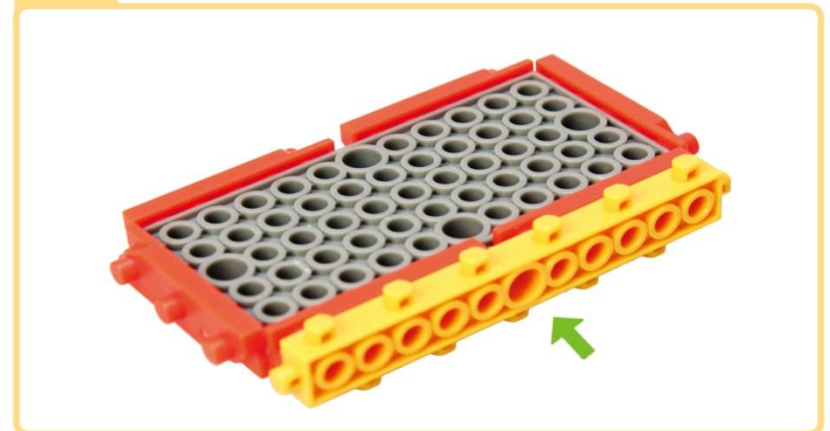

Добавляем подставку



7

组装得好不好

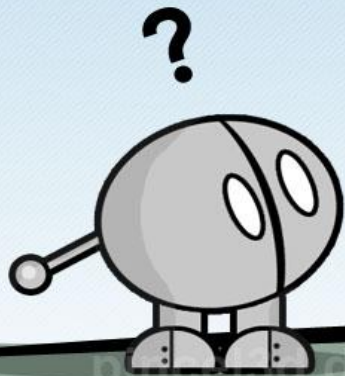
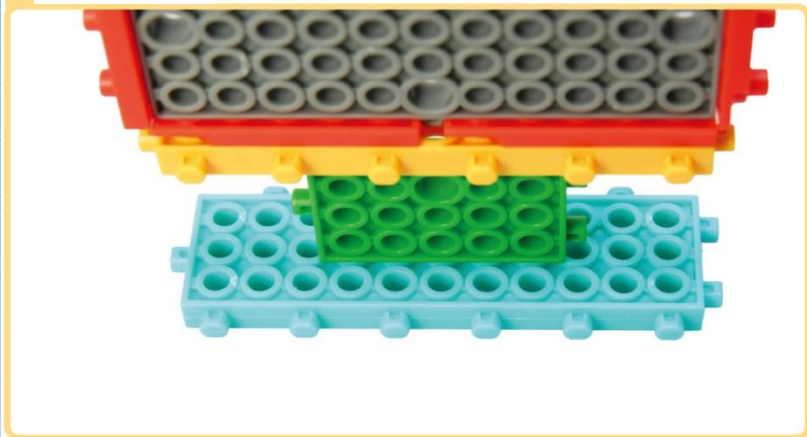

ГОТОВО!

До встречи!

