

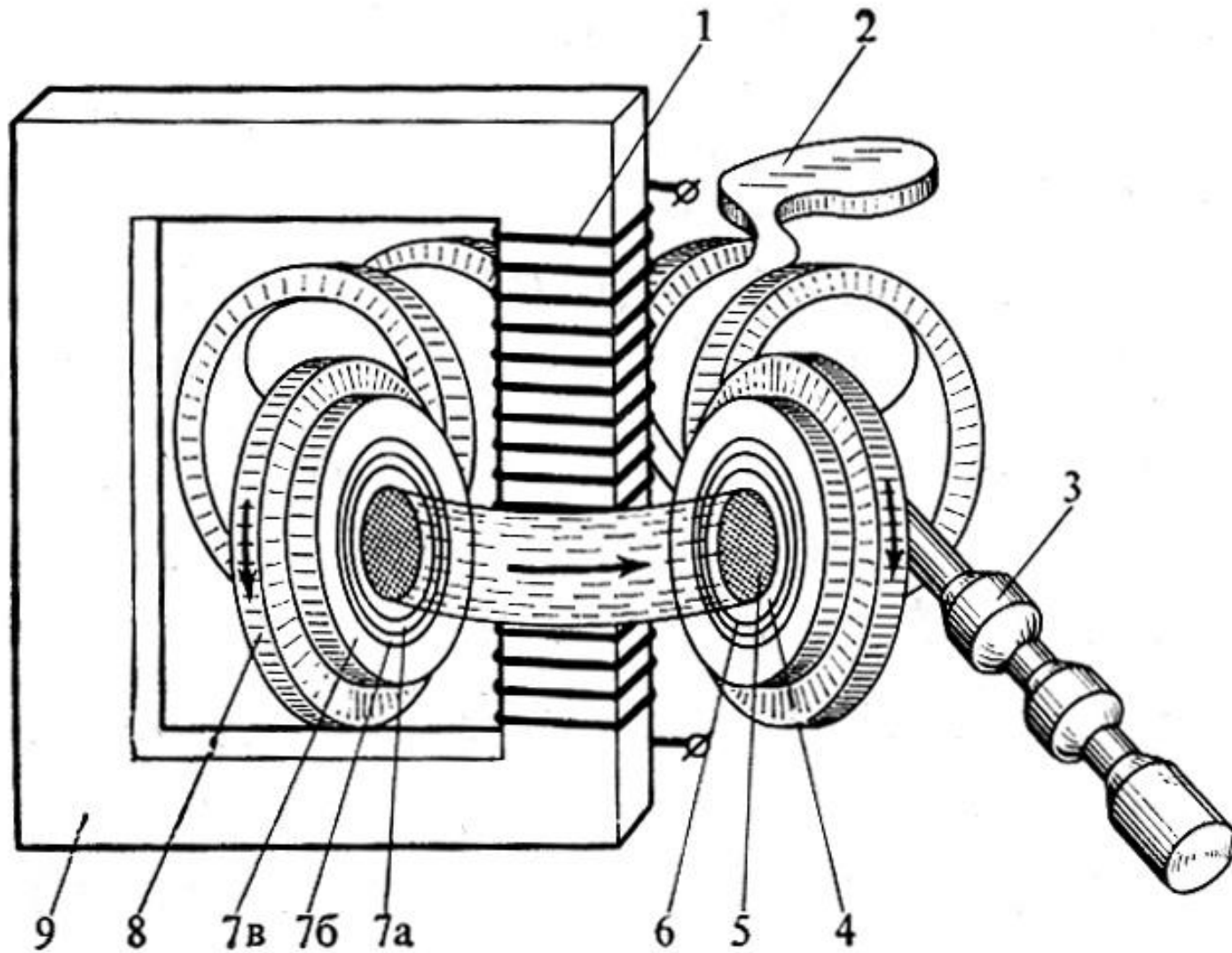

ПОЛИТЕХ
Институт энергетики
и транспортных систем

Термоядерная энергетика

Схема термоядерного реактора на основе токамака



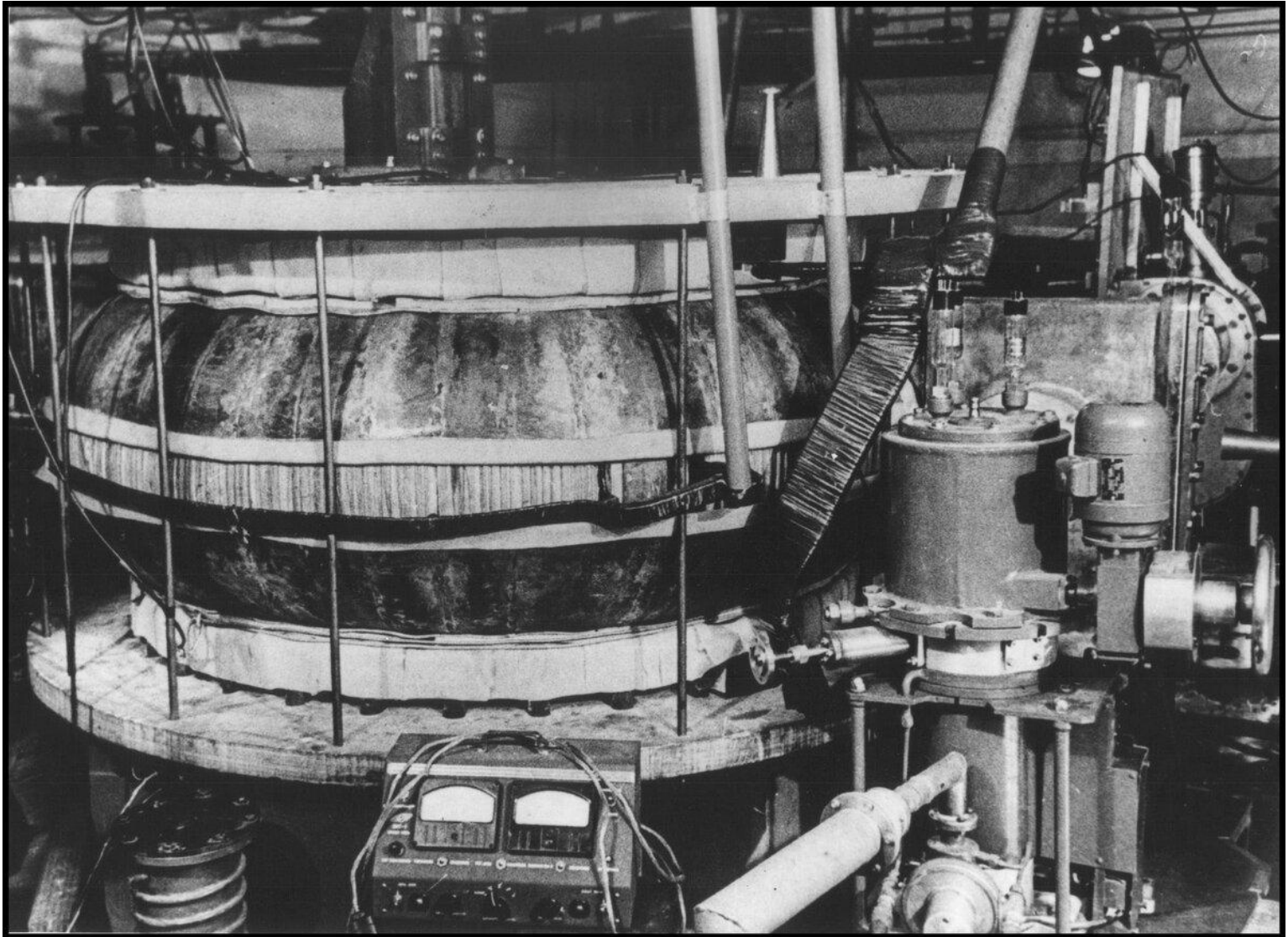

TOKAMAK T-1

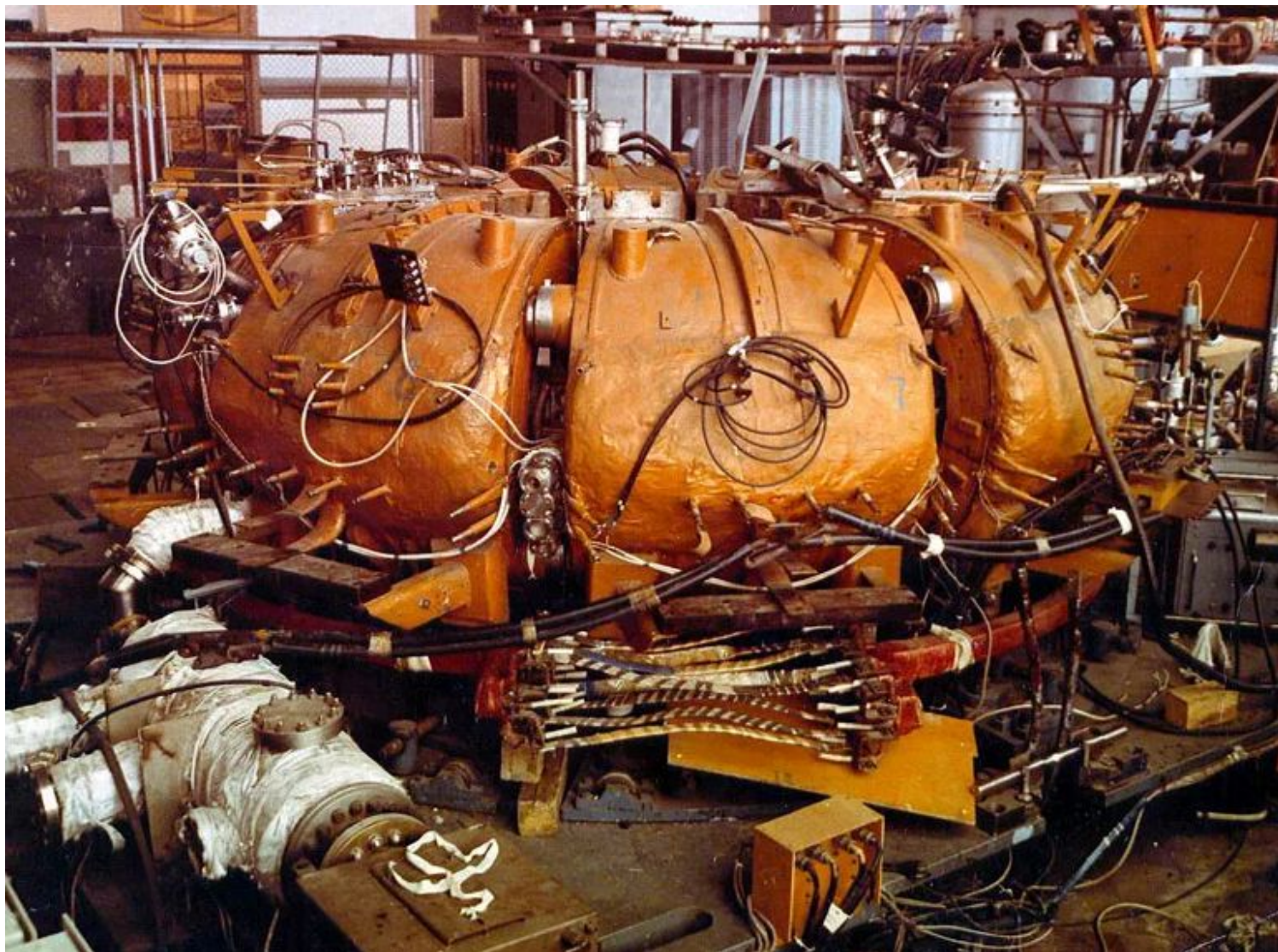

TOKAMAK "TM-3"

Проект ITER (ИТЕР)



Реактор ITER

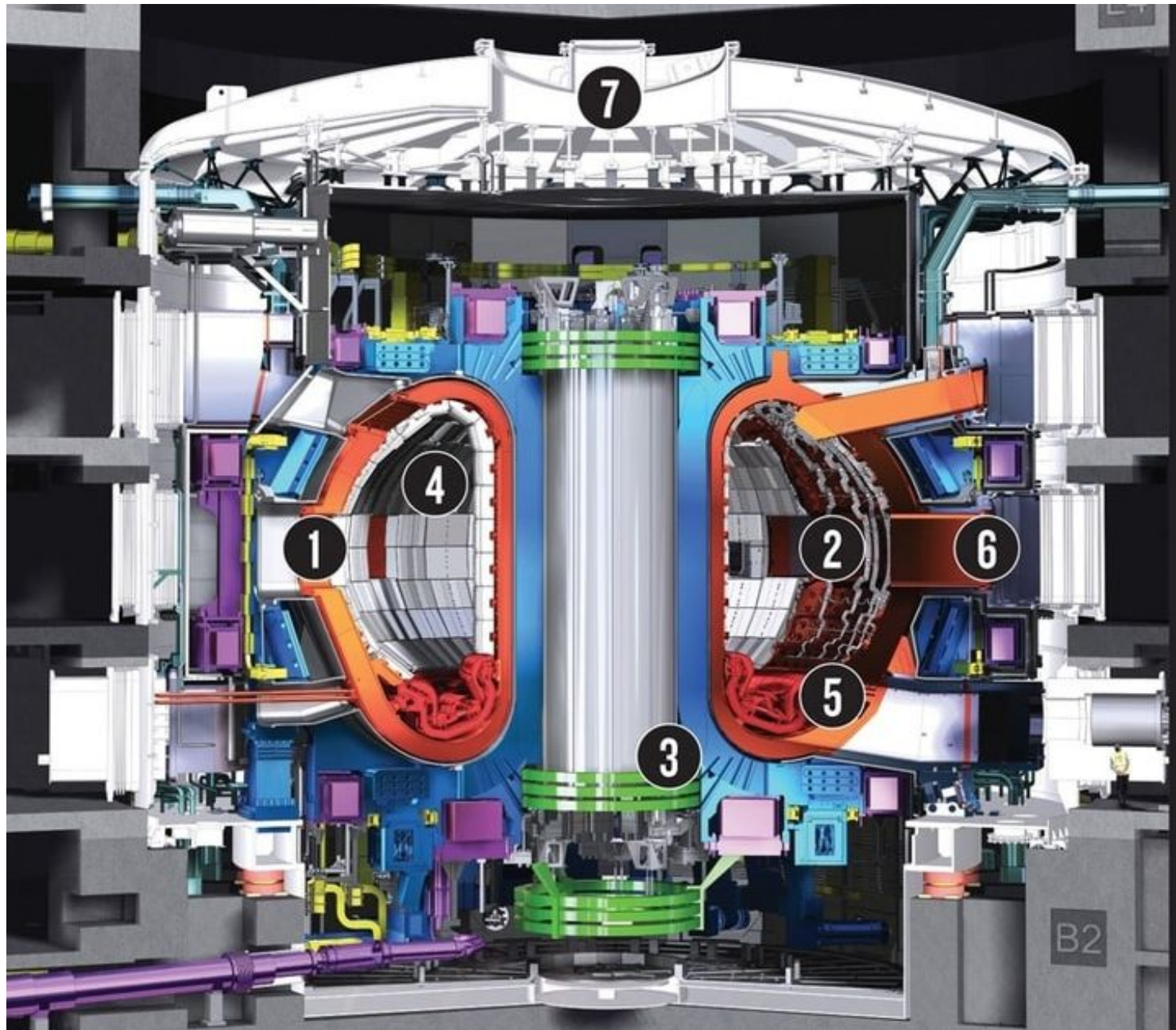

Вакуумная камера

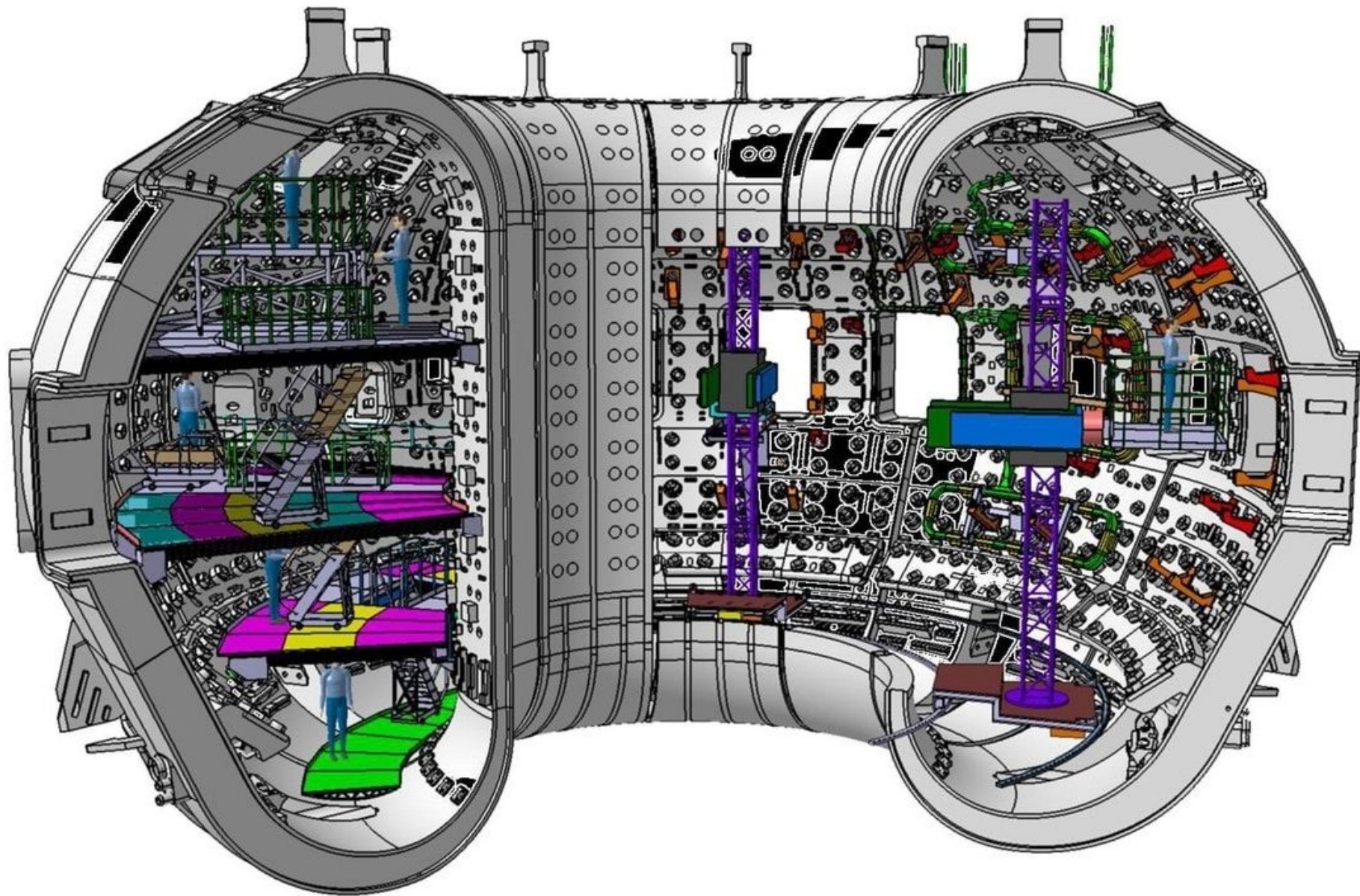

Модель криостата

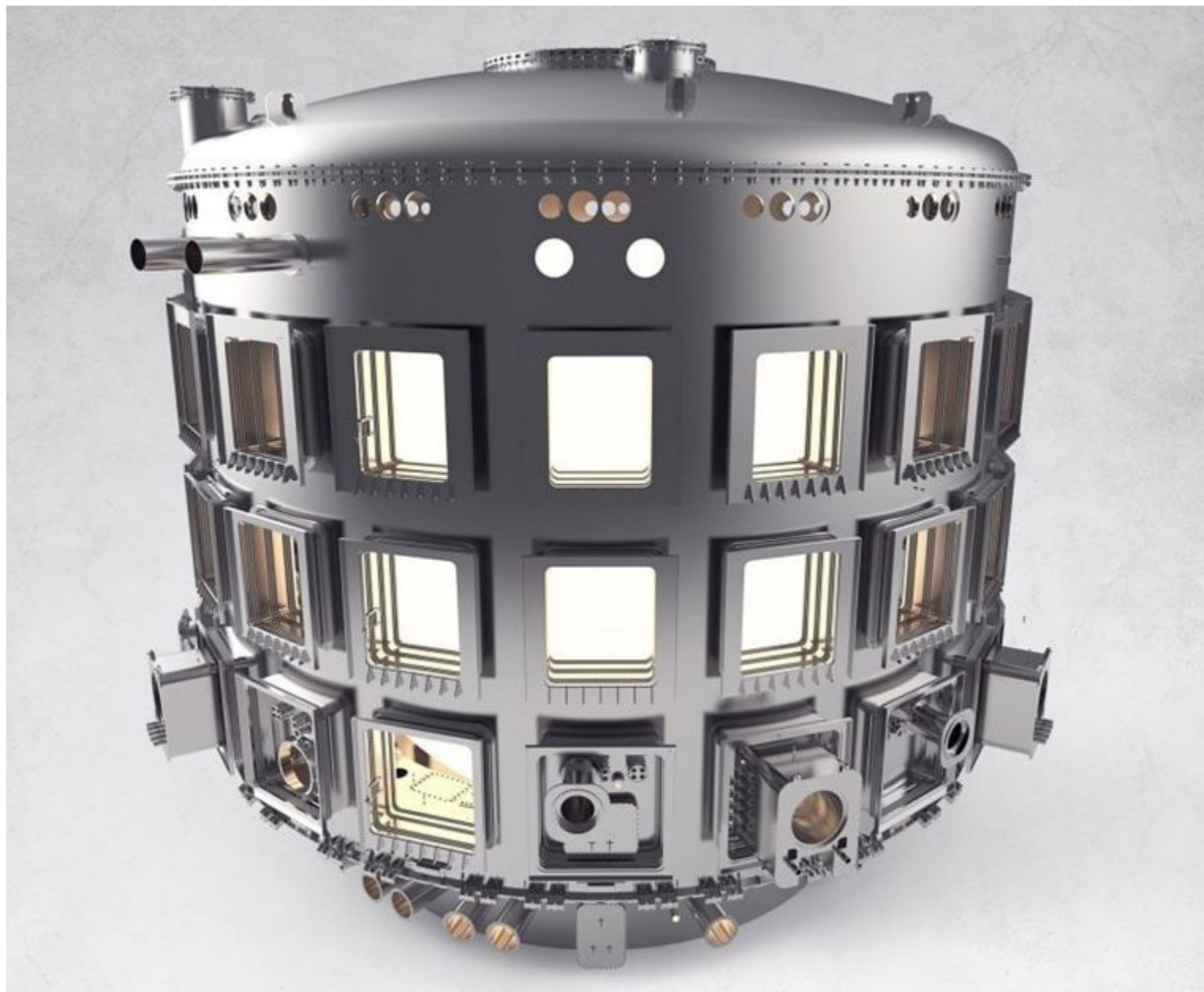

Сборка криостата





Корпус тороидальной катушки

