

Гузенко экстракторы

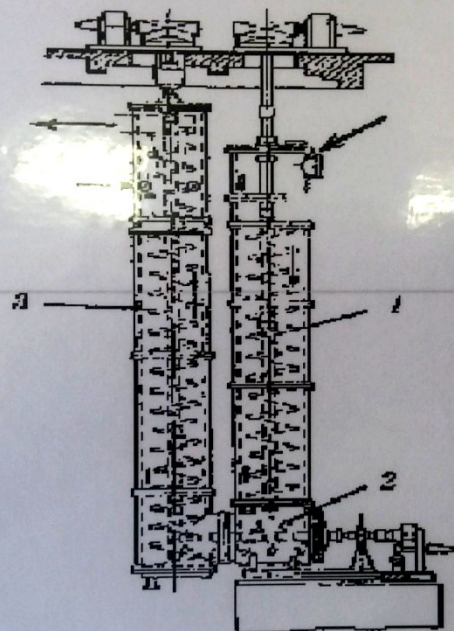

1-шикізат; 2-сорып алгыш қондырғы; 3-шрот, экстрагент.



Рис. 102. Схема производства жидкого концентрата горьцвета. Объяснение в тексте.







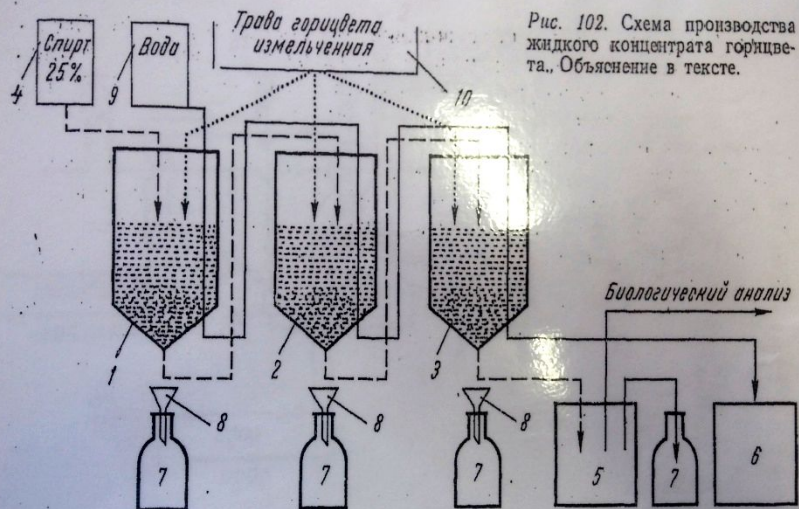
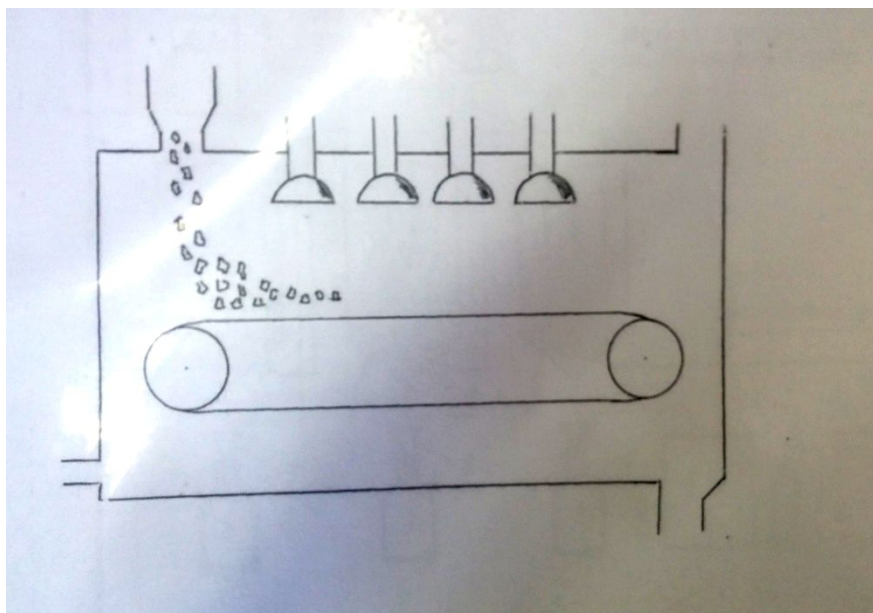
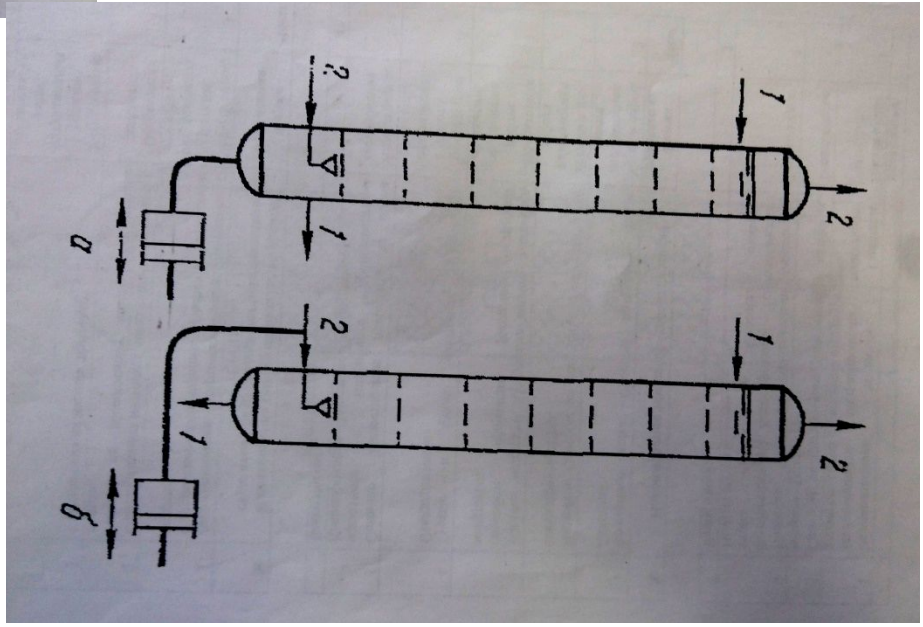
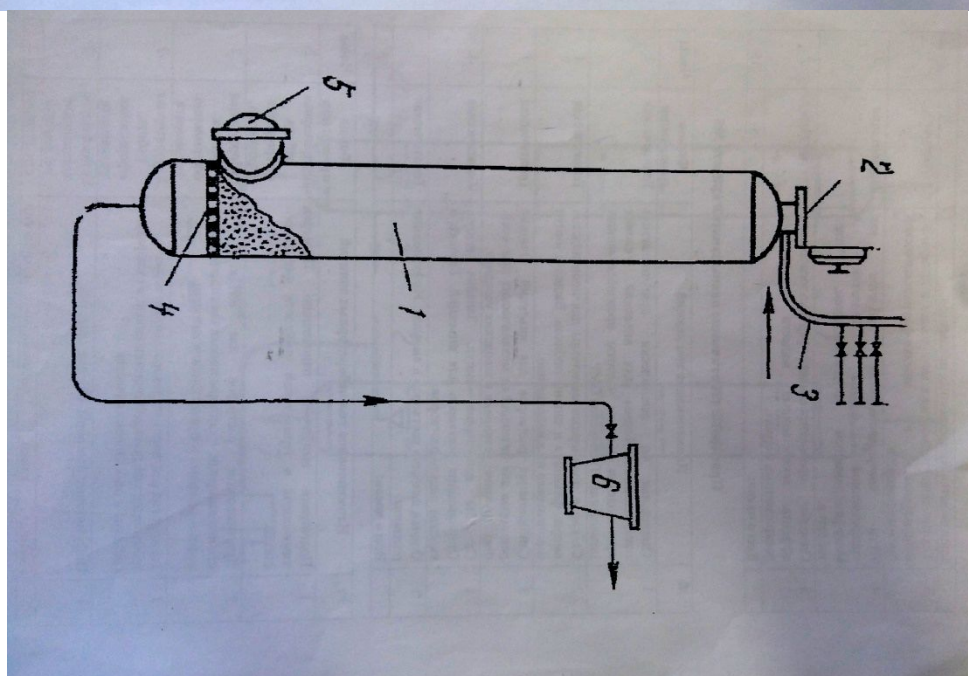
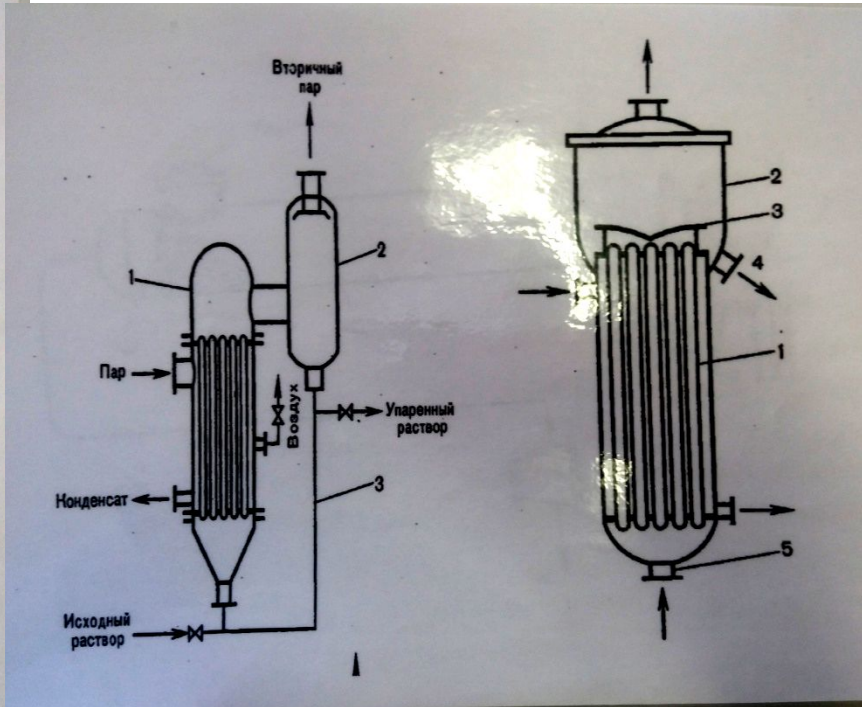
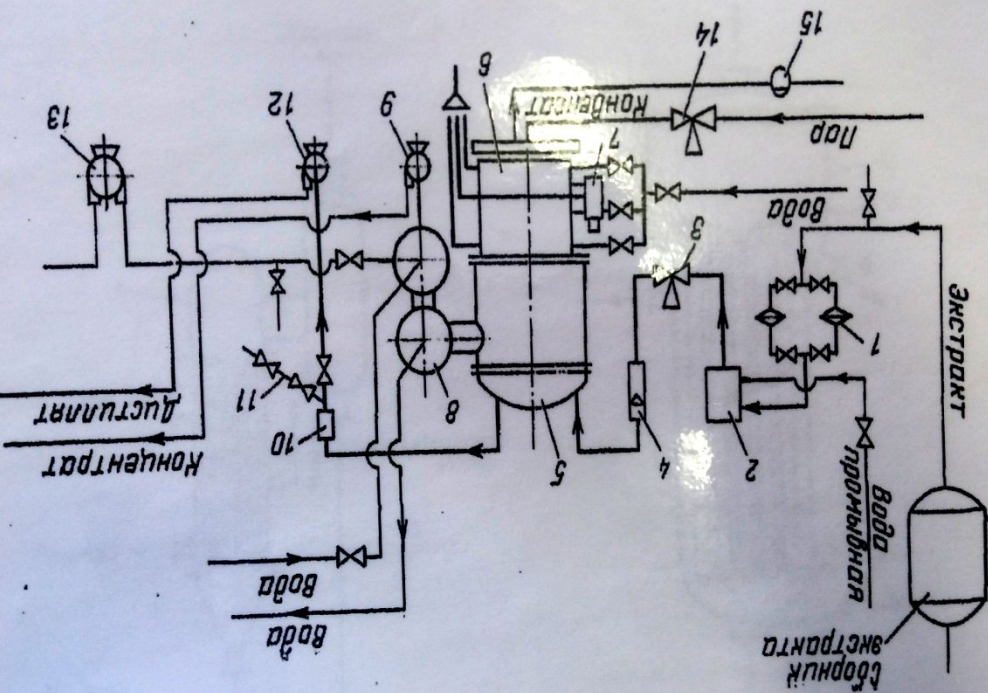
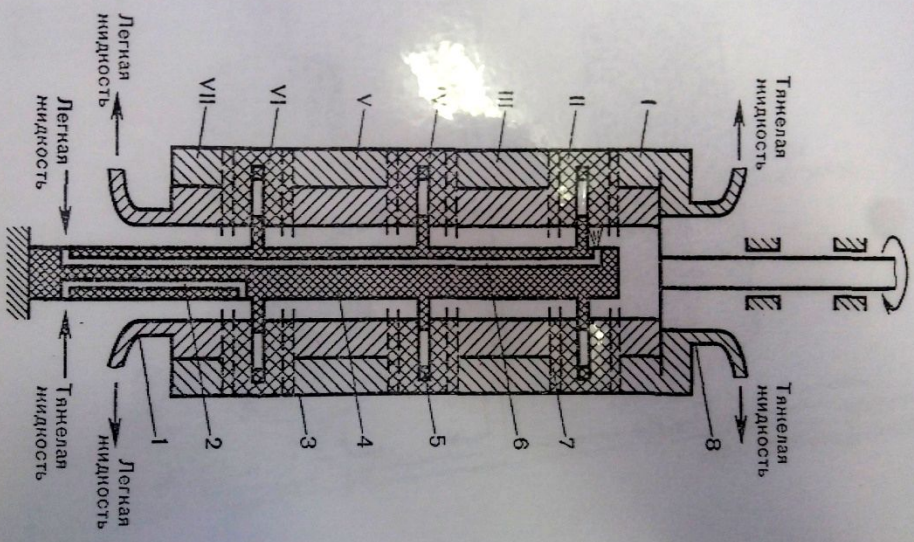
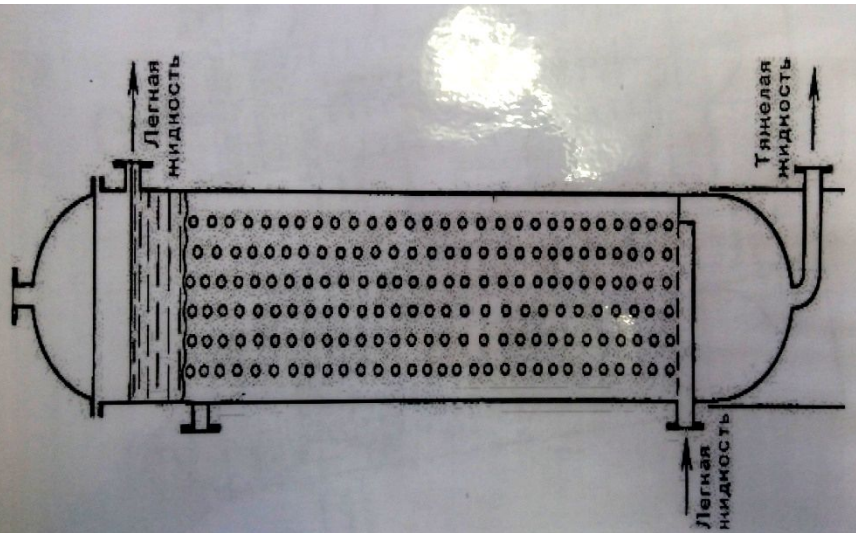
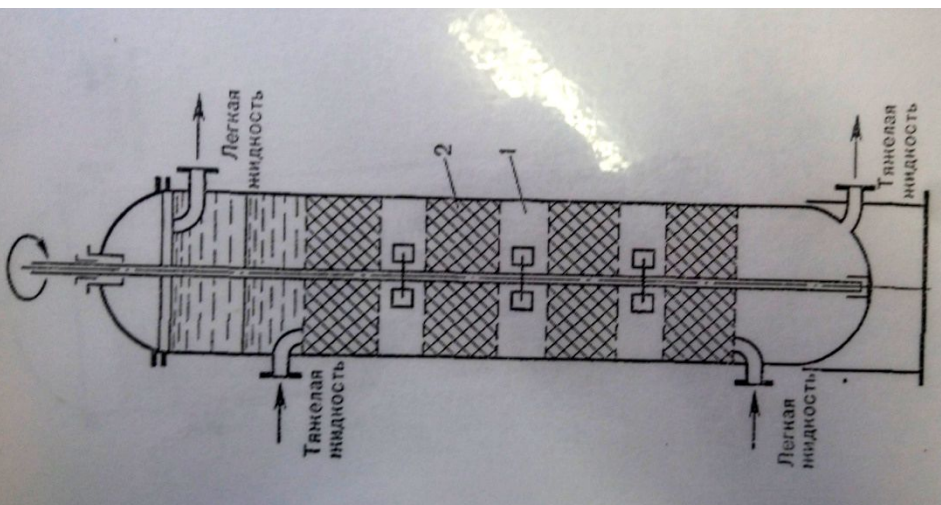
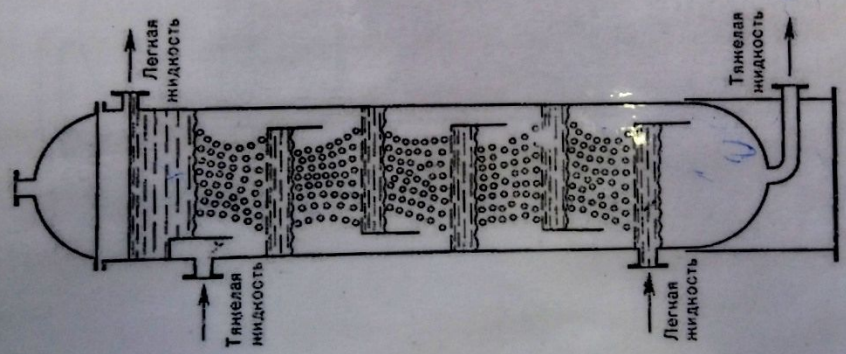
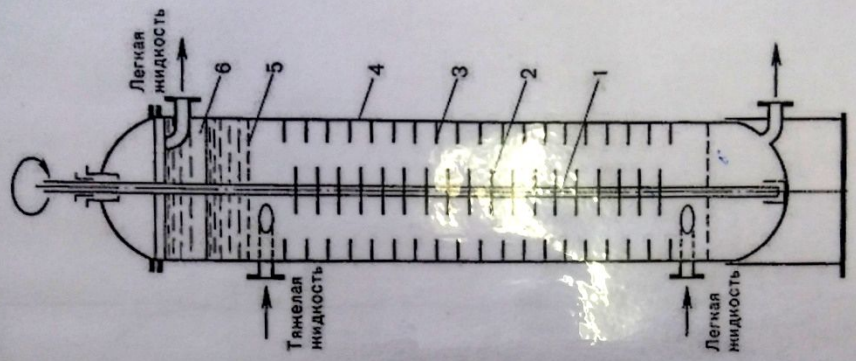



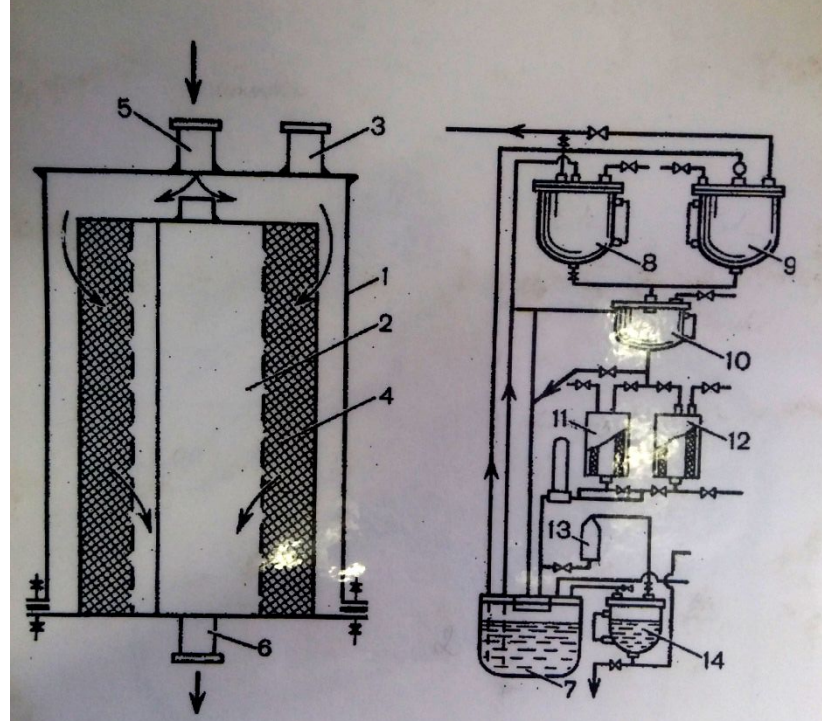
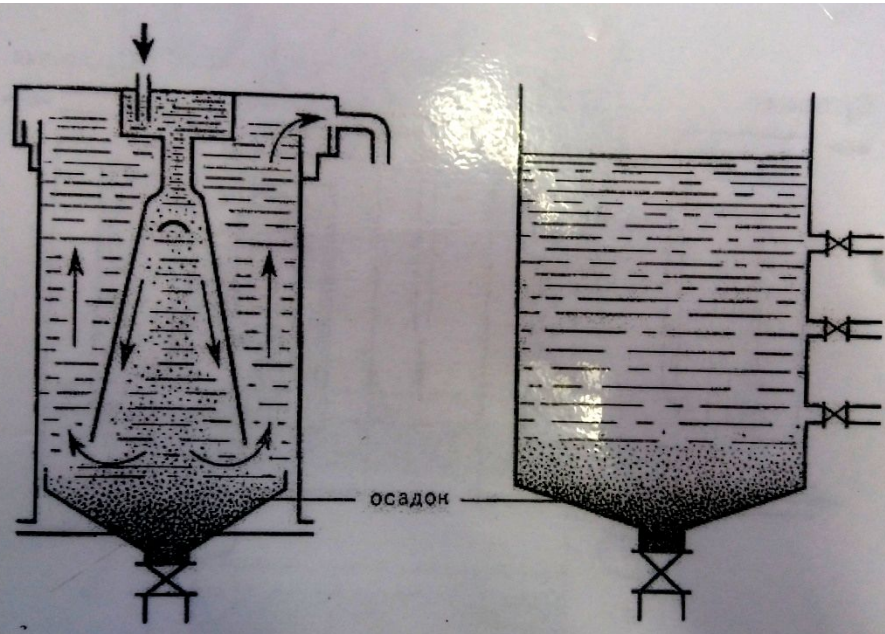
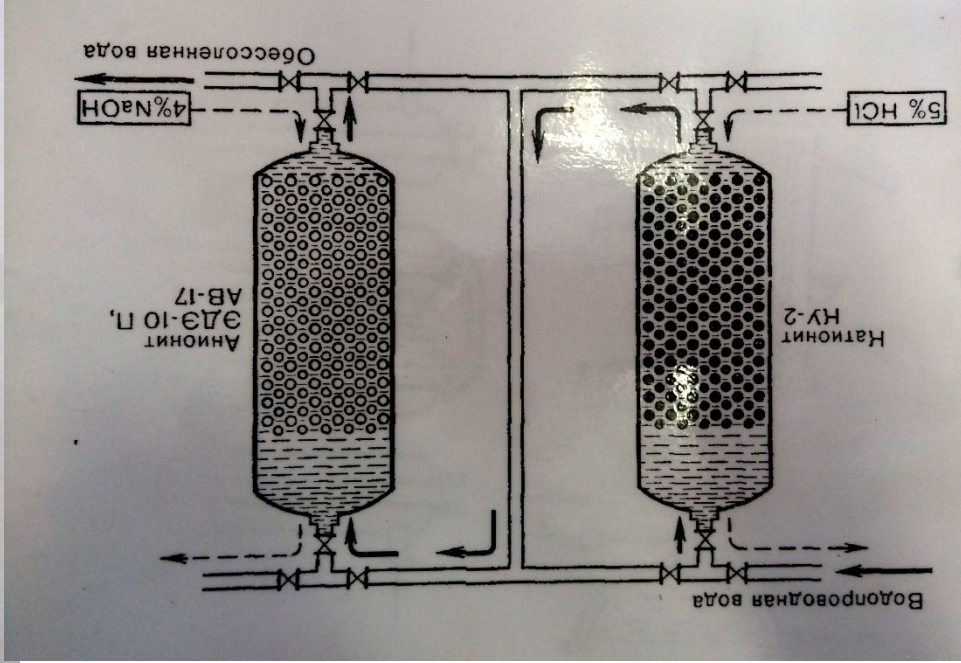
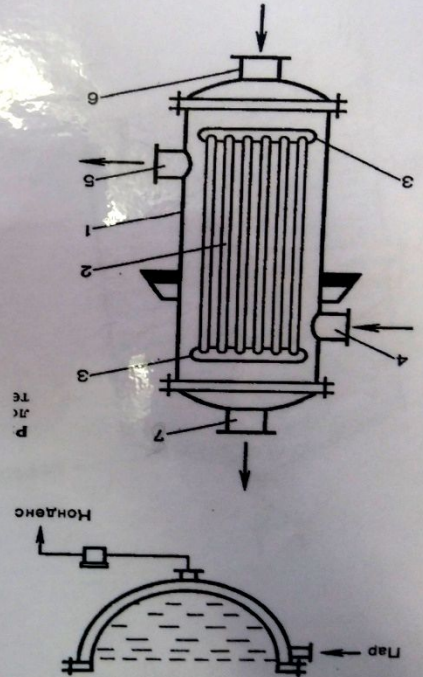
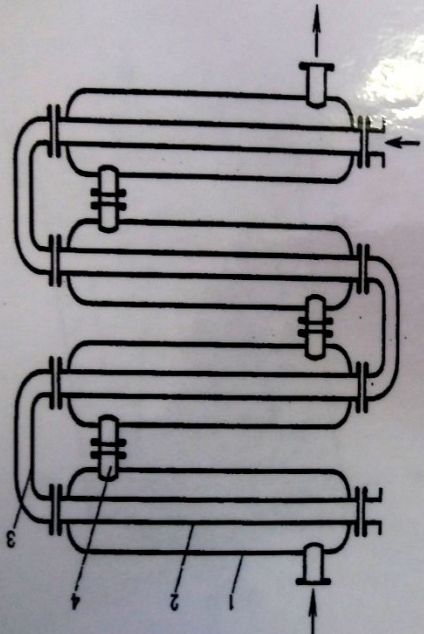



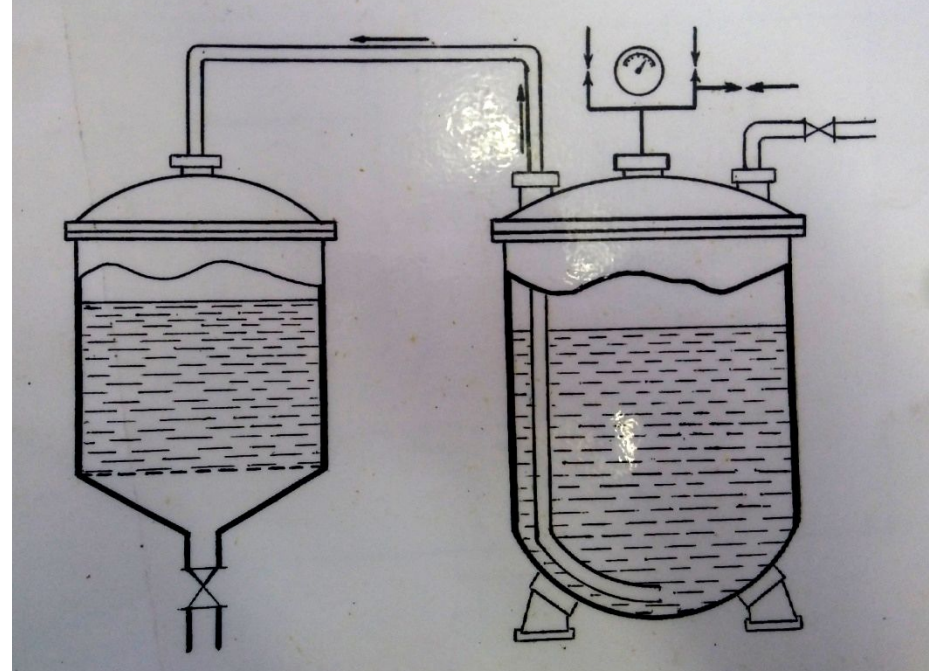
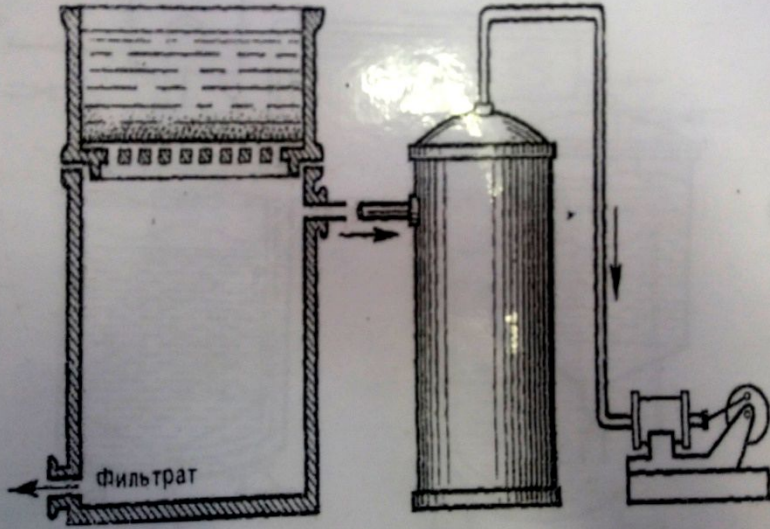
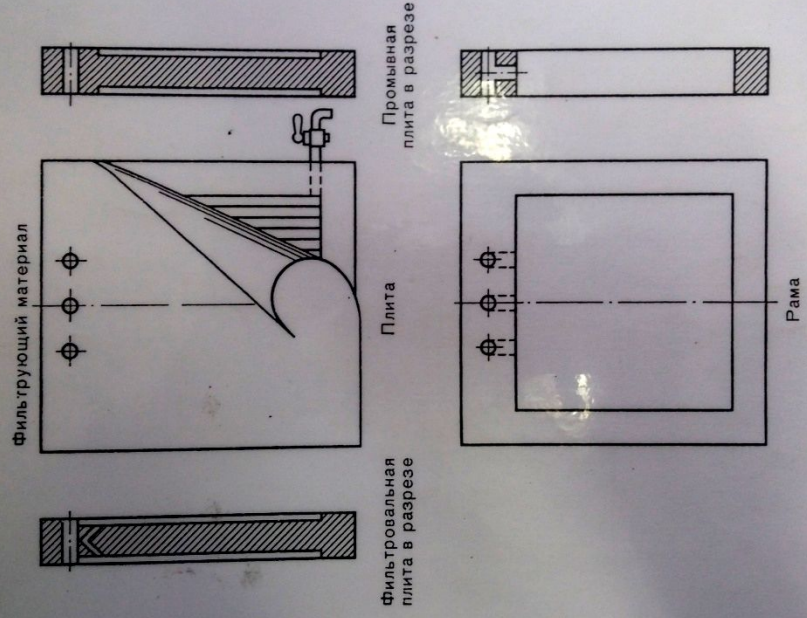
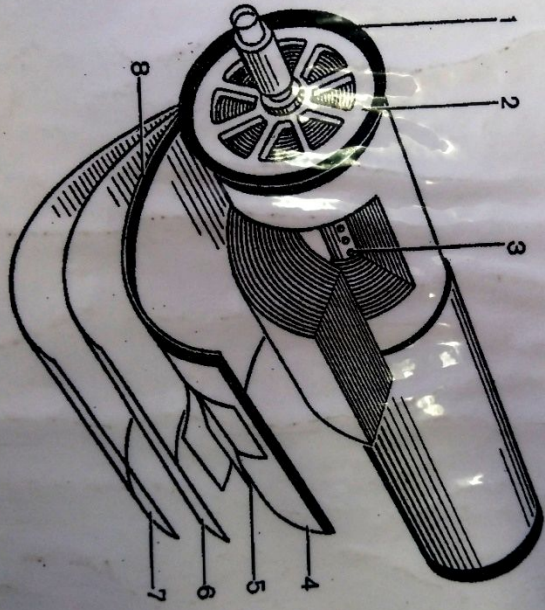



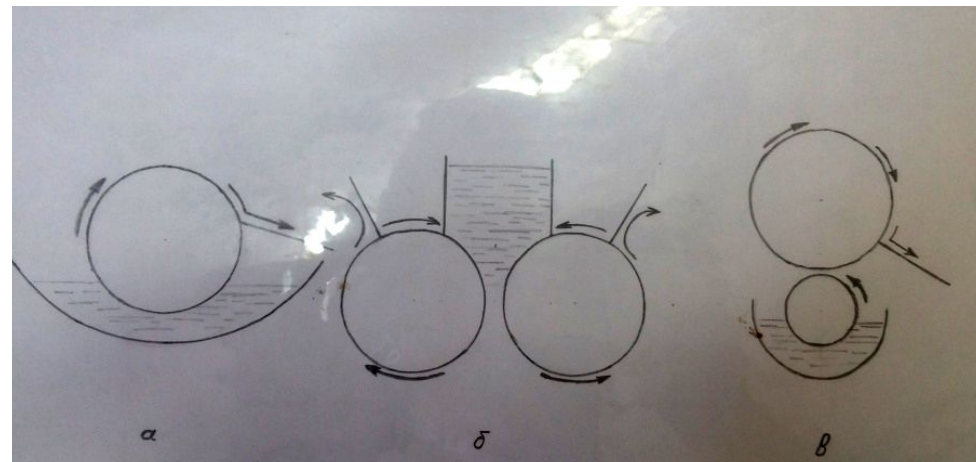
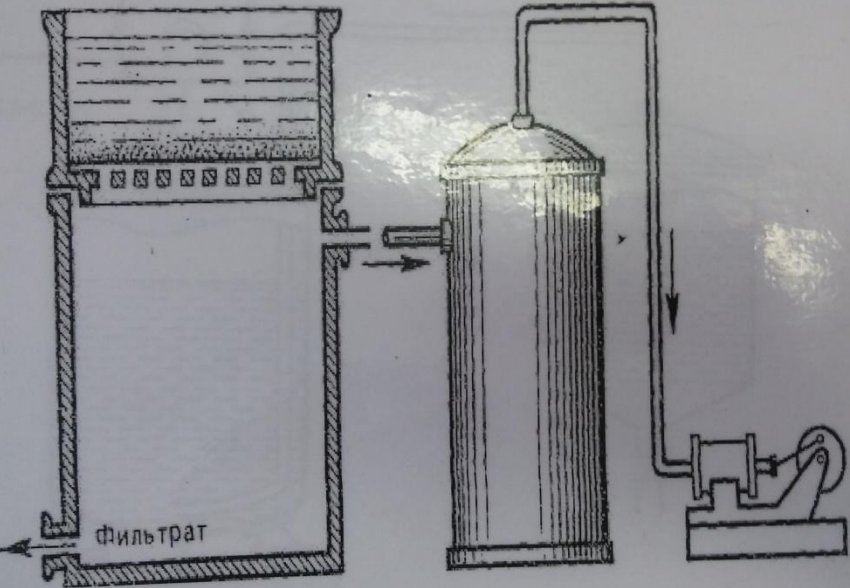
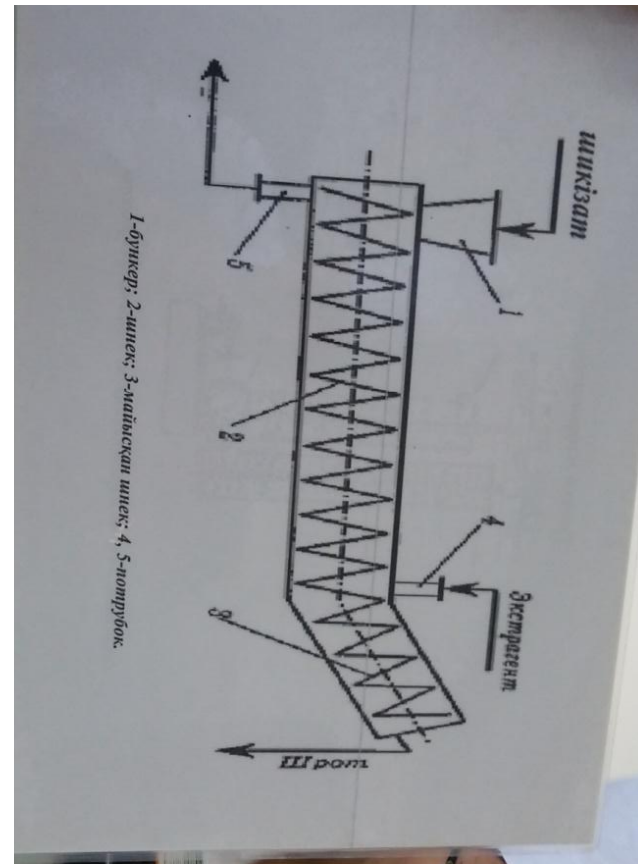
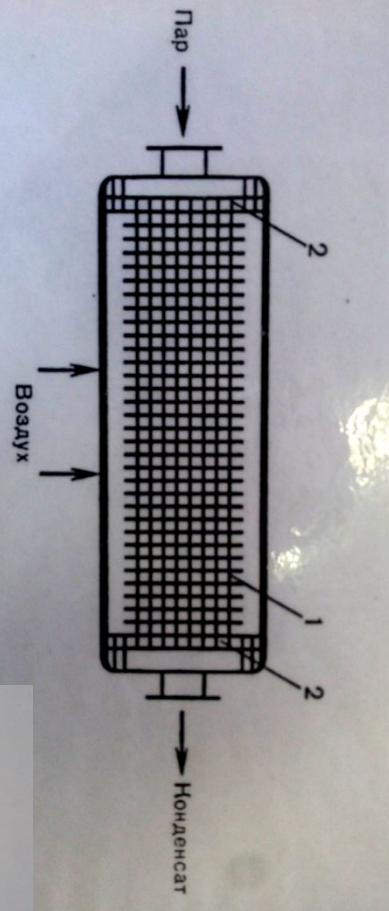
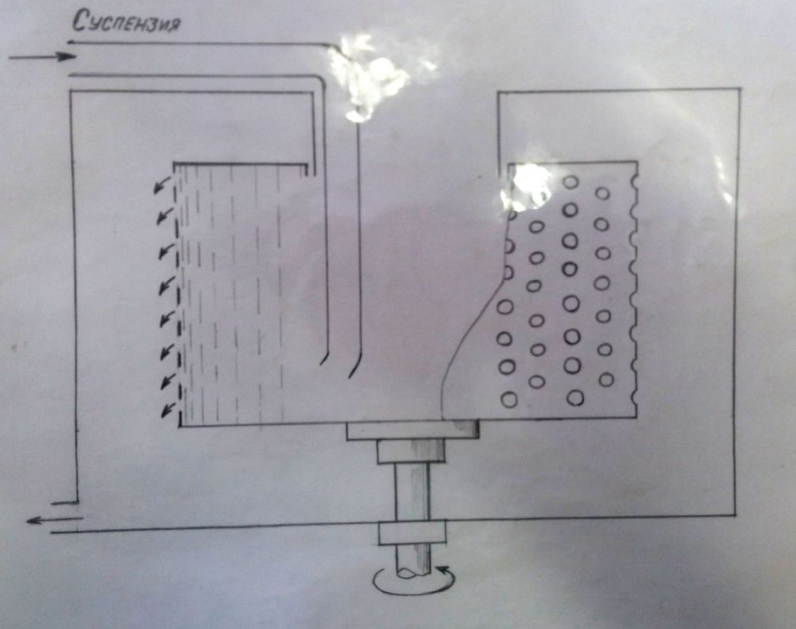

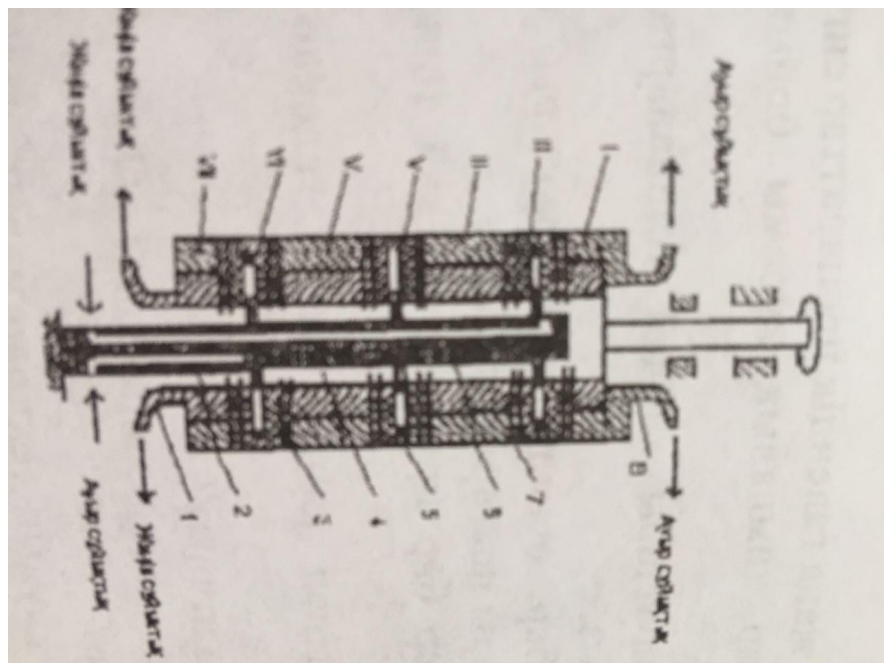
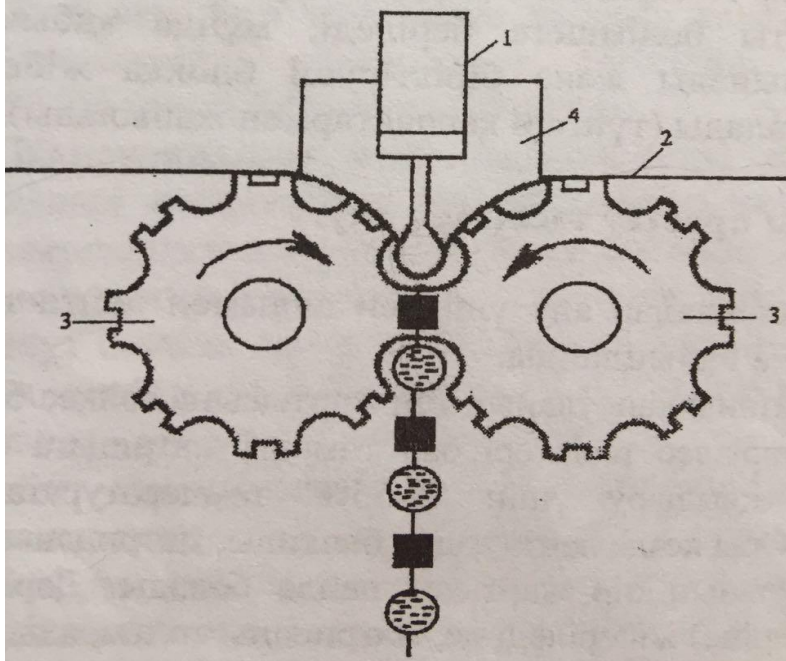
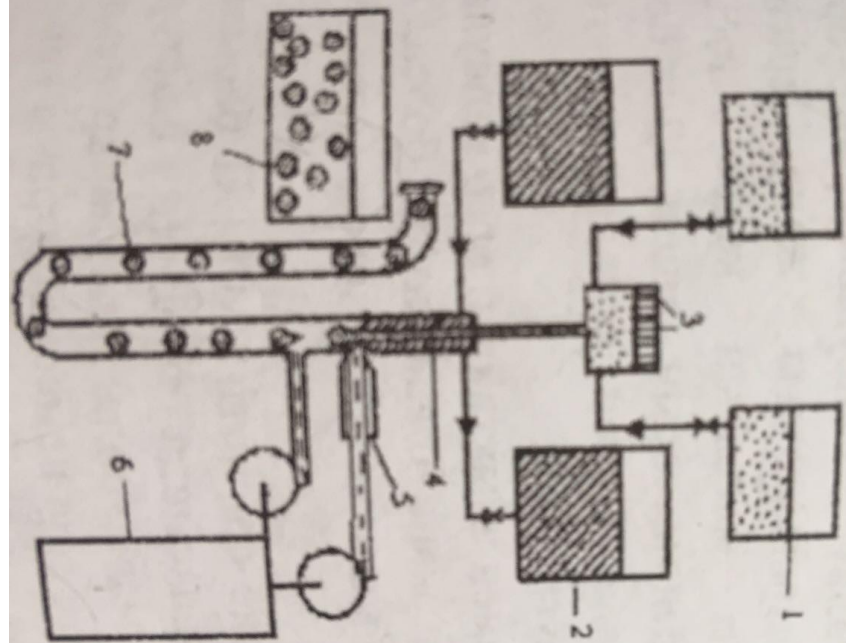
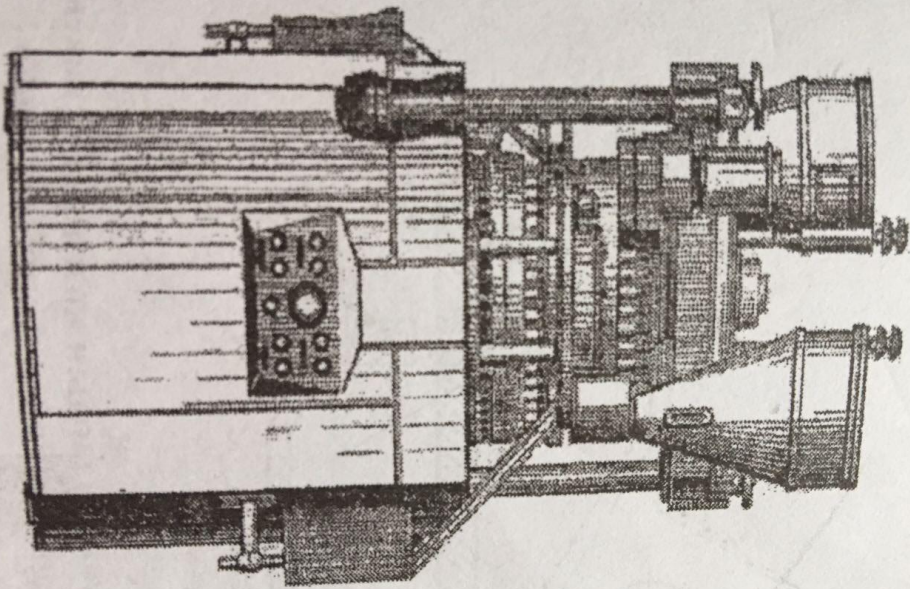



Механика

