



Improve Your Vocabulary

House

www.kids-pages.com

Kids-**P**ages



chimney

roof

attic

balcony

fence

windows

lights

door

garage

shutters

walls

garden

basement

driveway

drainpipes

porch

stairs

path

swimming pool

mailbox

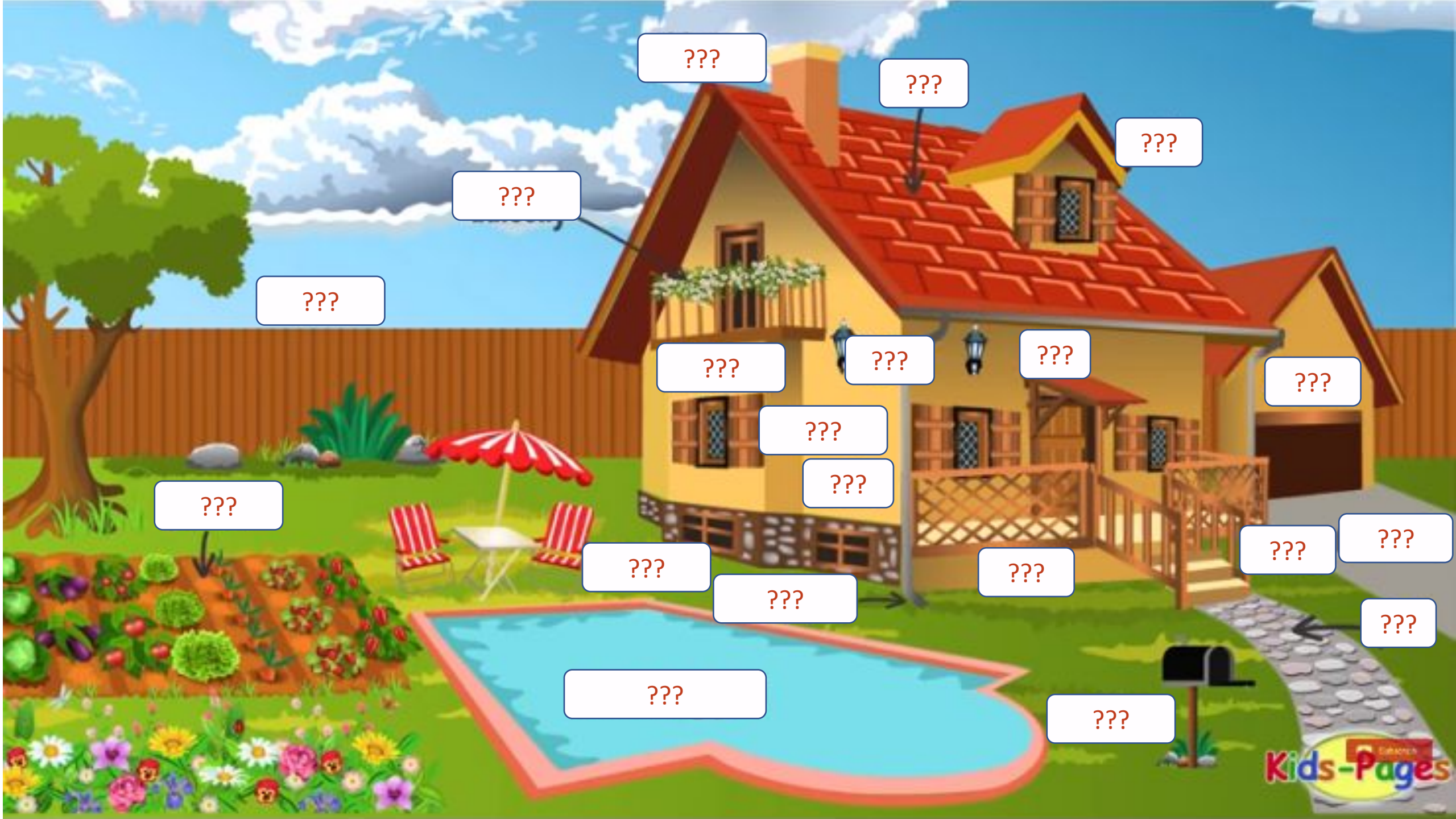

???

???

???

???

???

???

???

???

???

???

???

???

???

???

???

???

???

???

???

???



Fill in the missing vowels for each of the following words:

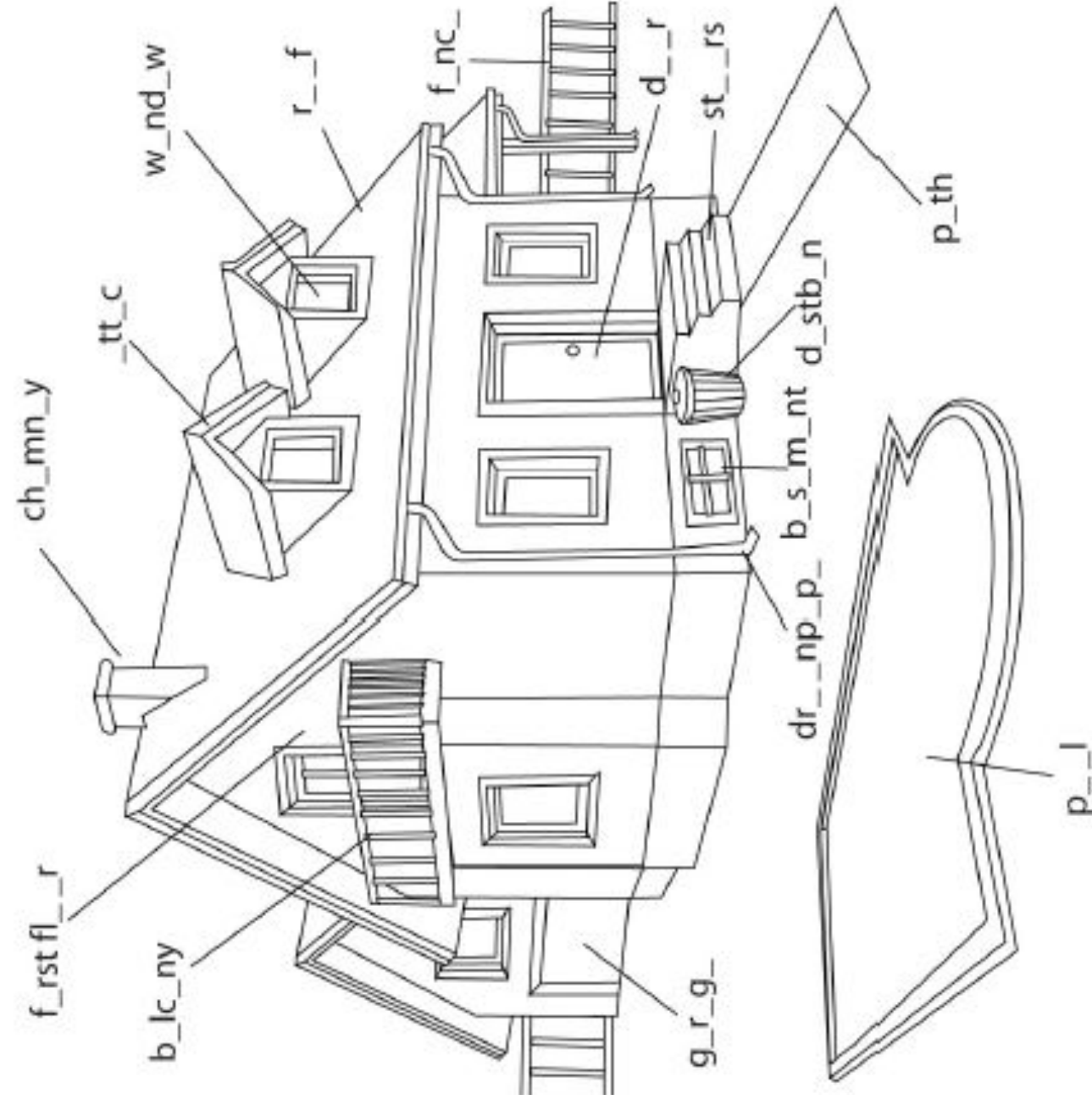



Rooms



attic



bedroom



laundry room



bathroom



study



living room



hallway



dining-room



kitchen



attic

???



???



???

???



???



???

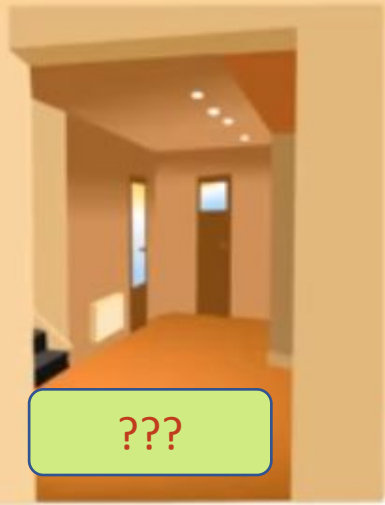

???

???





House Objects and Furniture

wall

curtains

window

chandelier

picture



floor lamp

sofa

cushion

armchair

table

floor

carpet

???

???

???

???

???

???



???

???

???



???

???

???

???

???

???

???

???



???



???

???

???



???

???

???

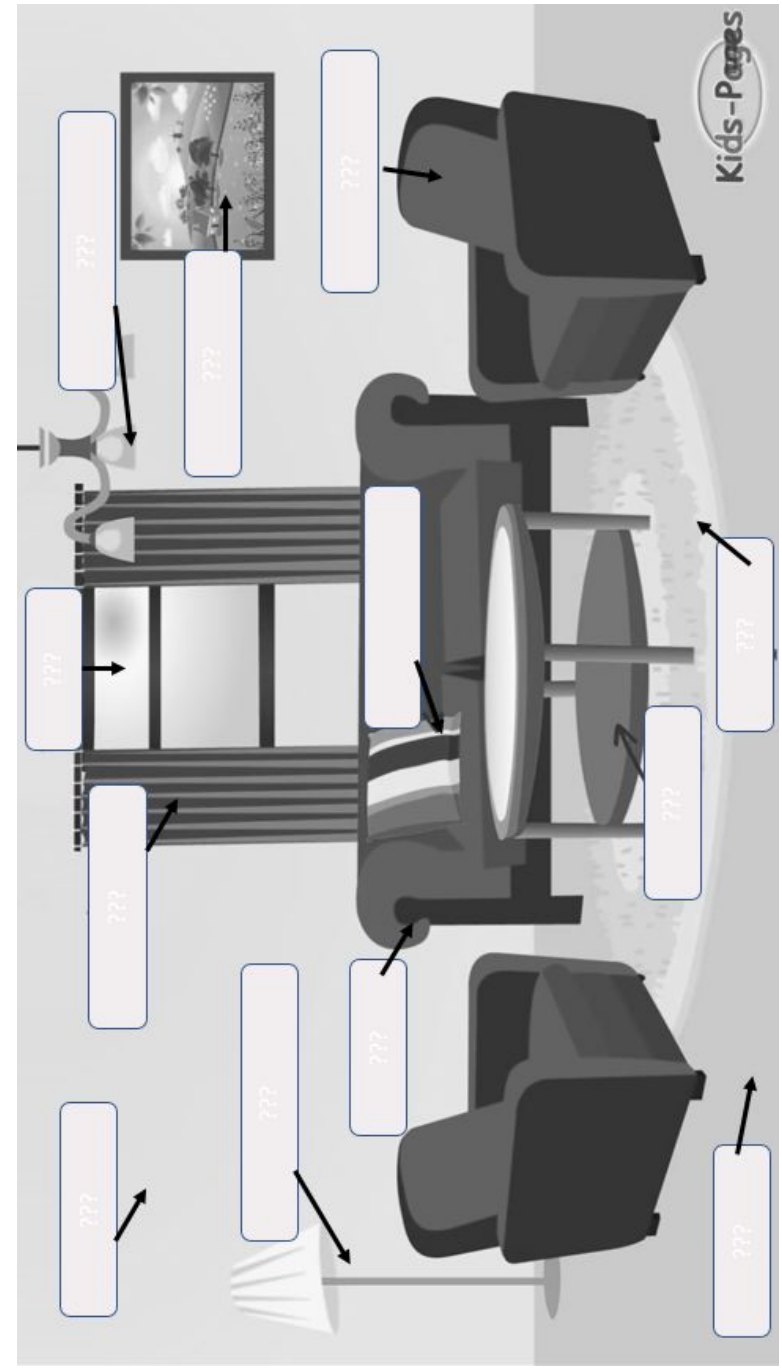
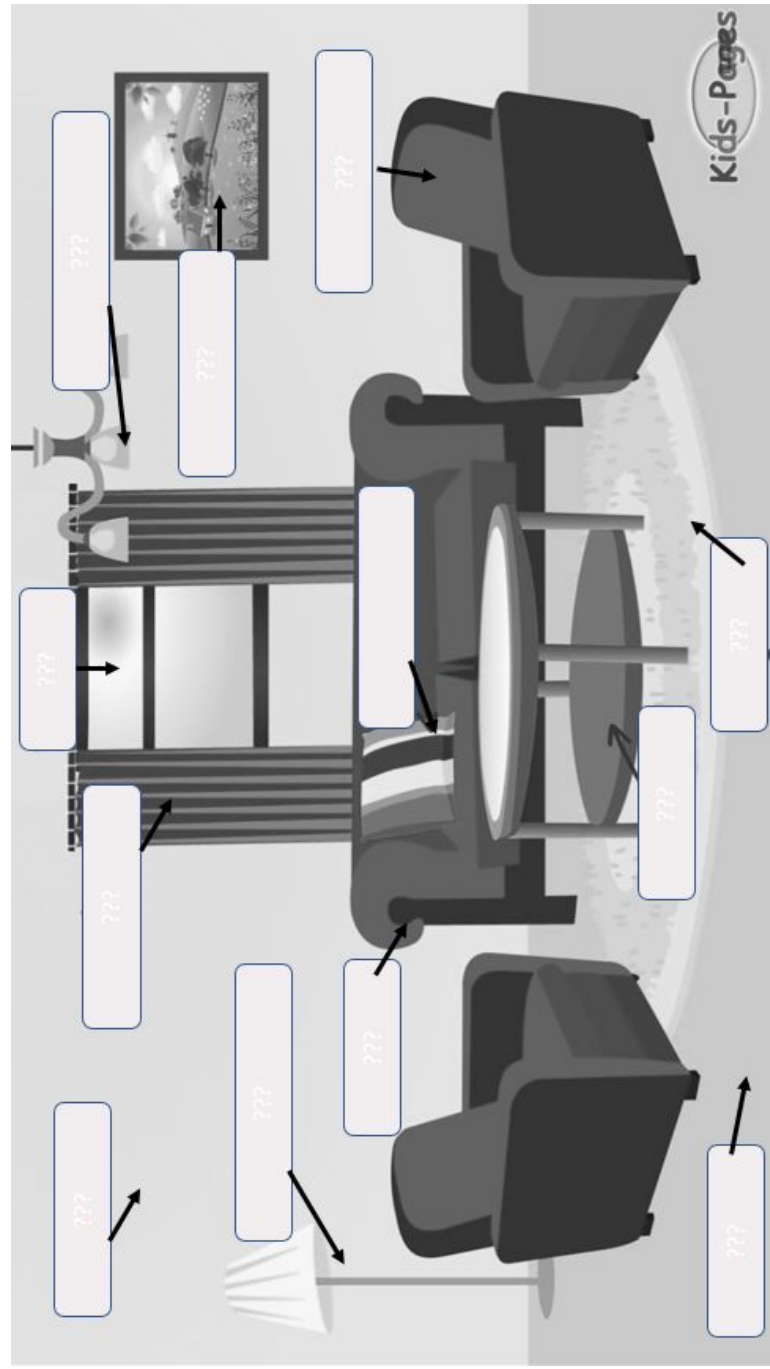
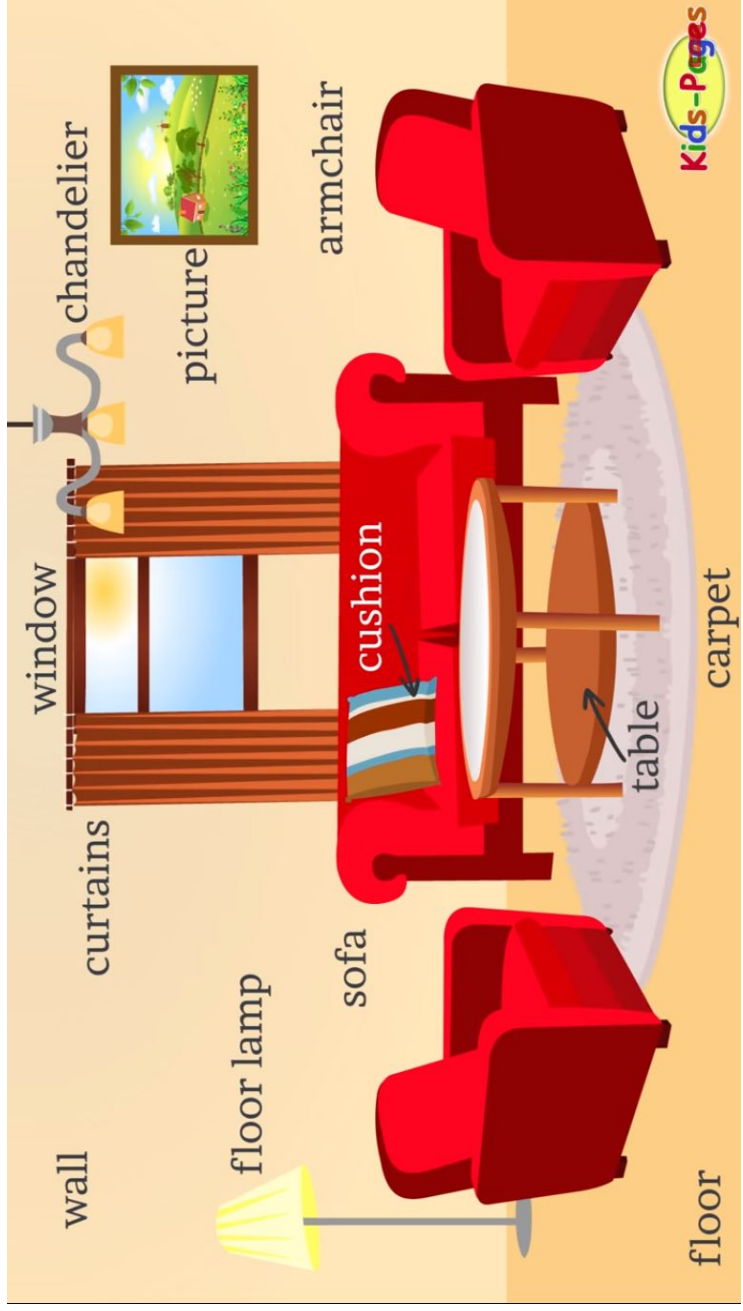



air conditioner

television



speaker



clock



fireplace



bookshelf



television
cabinet



remote control



???

???



???



???



???



???



???



???



???

???



???



???



???

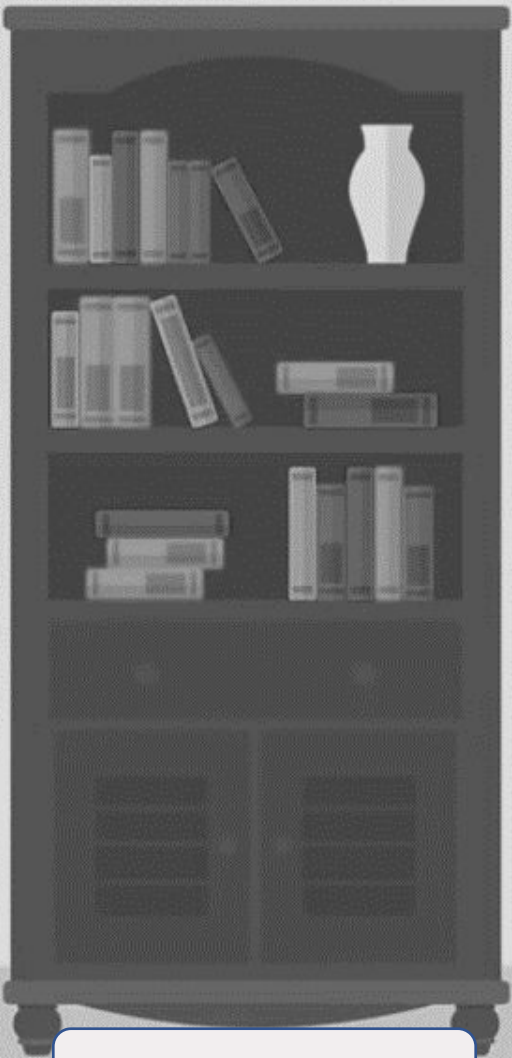

???



???



???



Bedroom



wardrobe

poster

dressing table

chest of drawers

shelf

lamp

pillows

blanket

bed

alarm clock

bedside table

rug

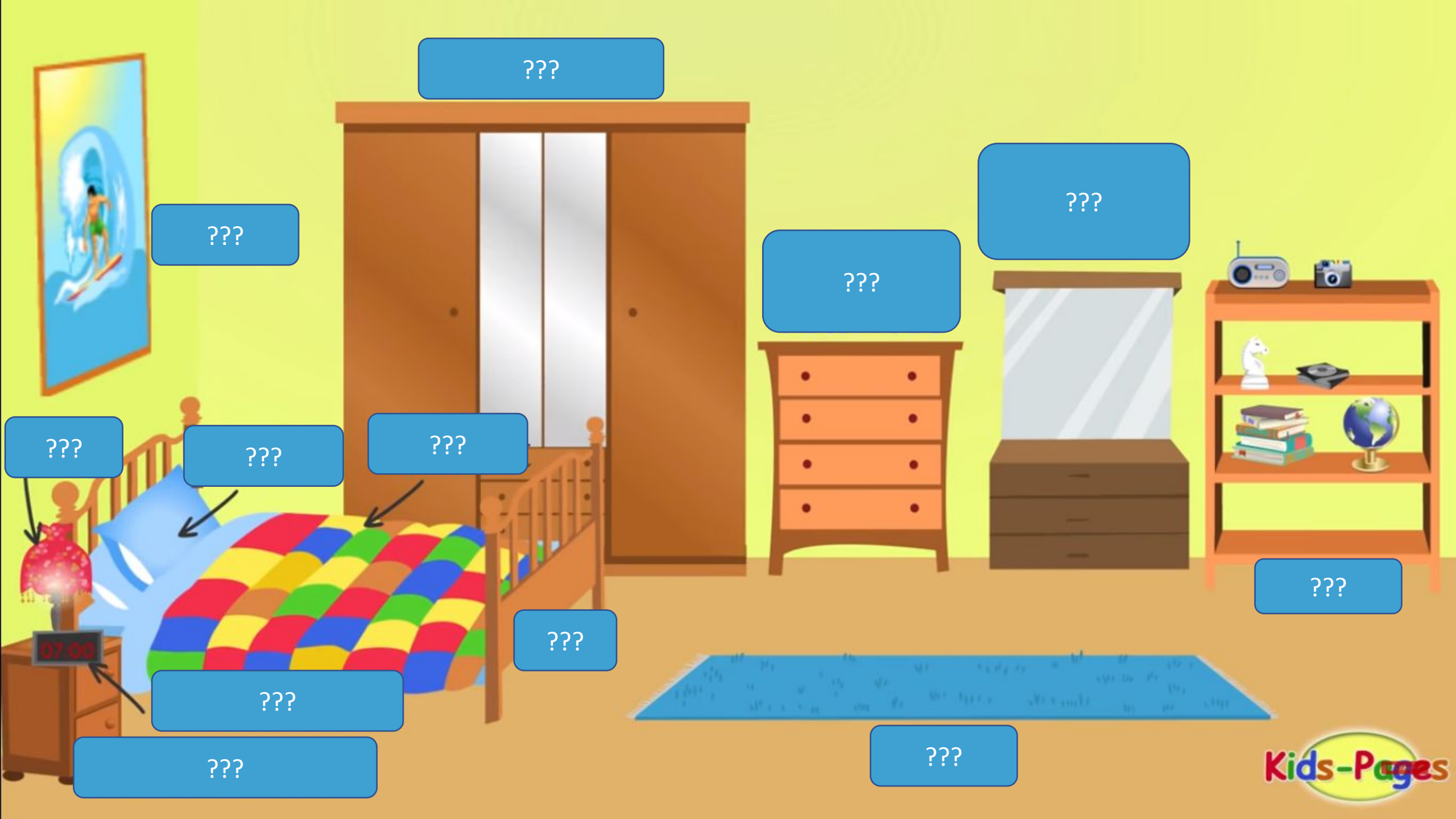

???

???

???

???

???

???

???

???

???

???

???

???

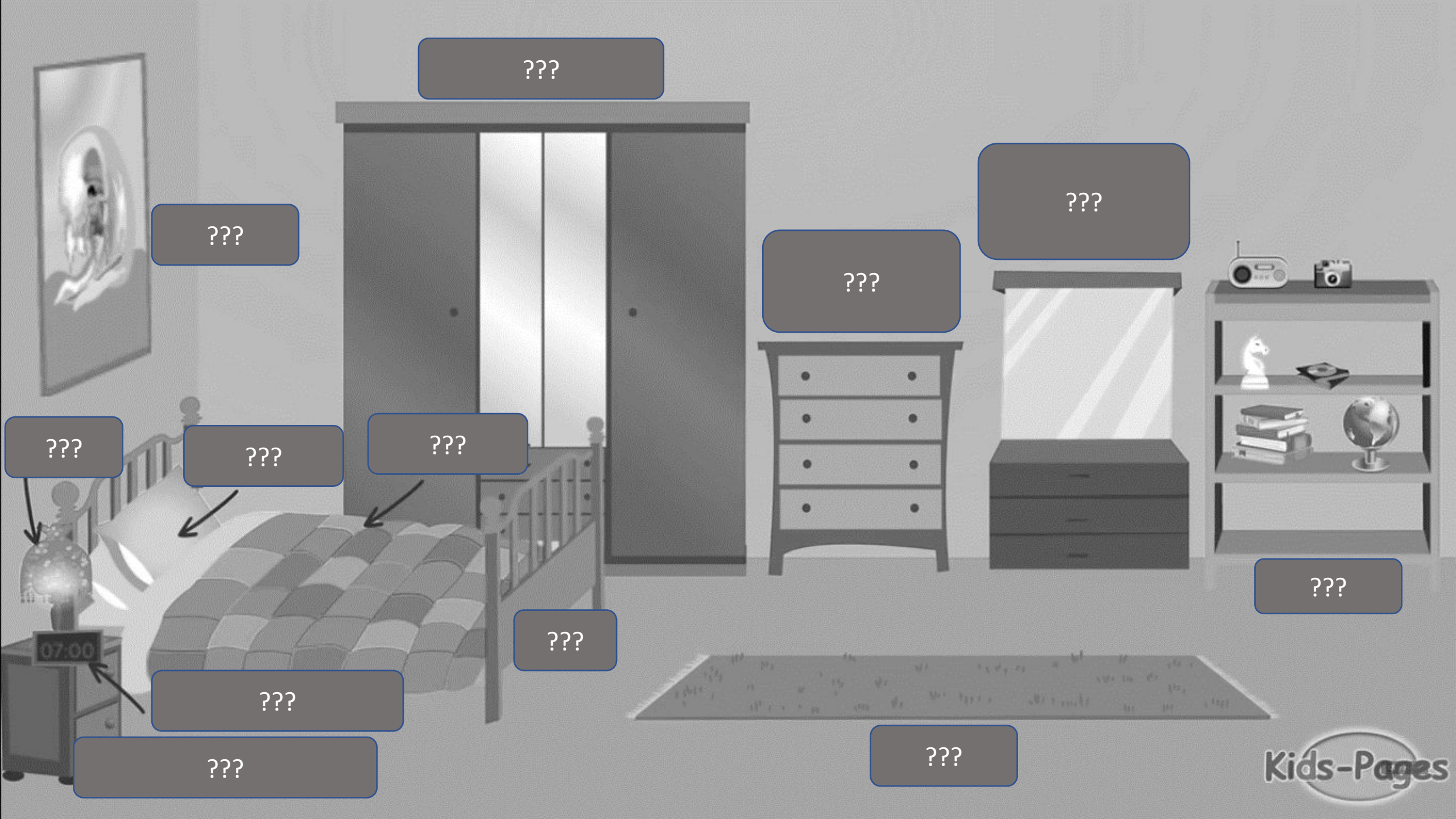

???

???

???

???



???

???

???

???

???

???

???

???

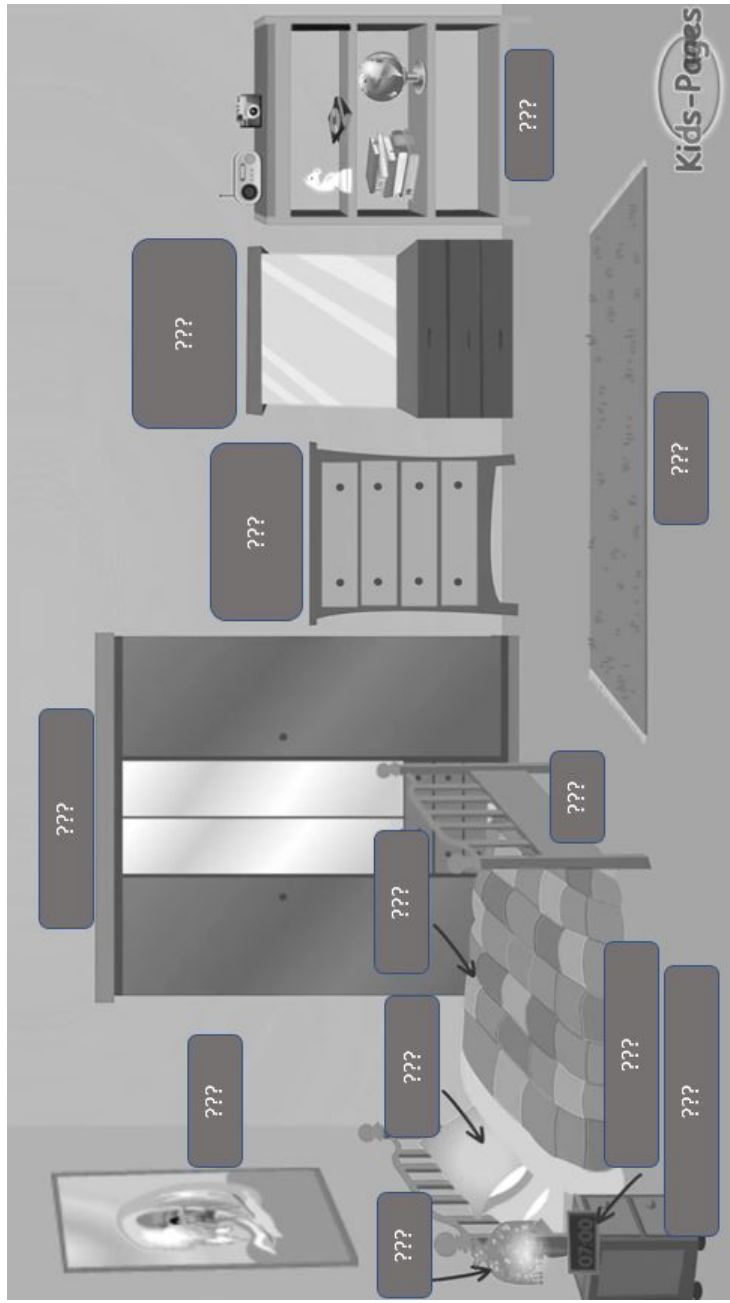
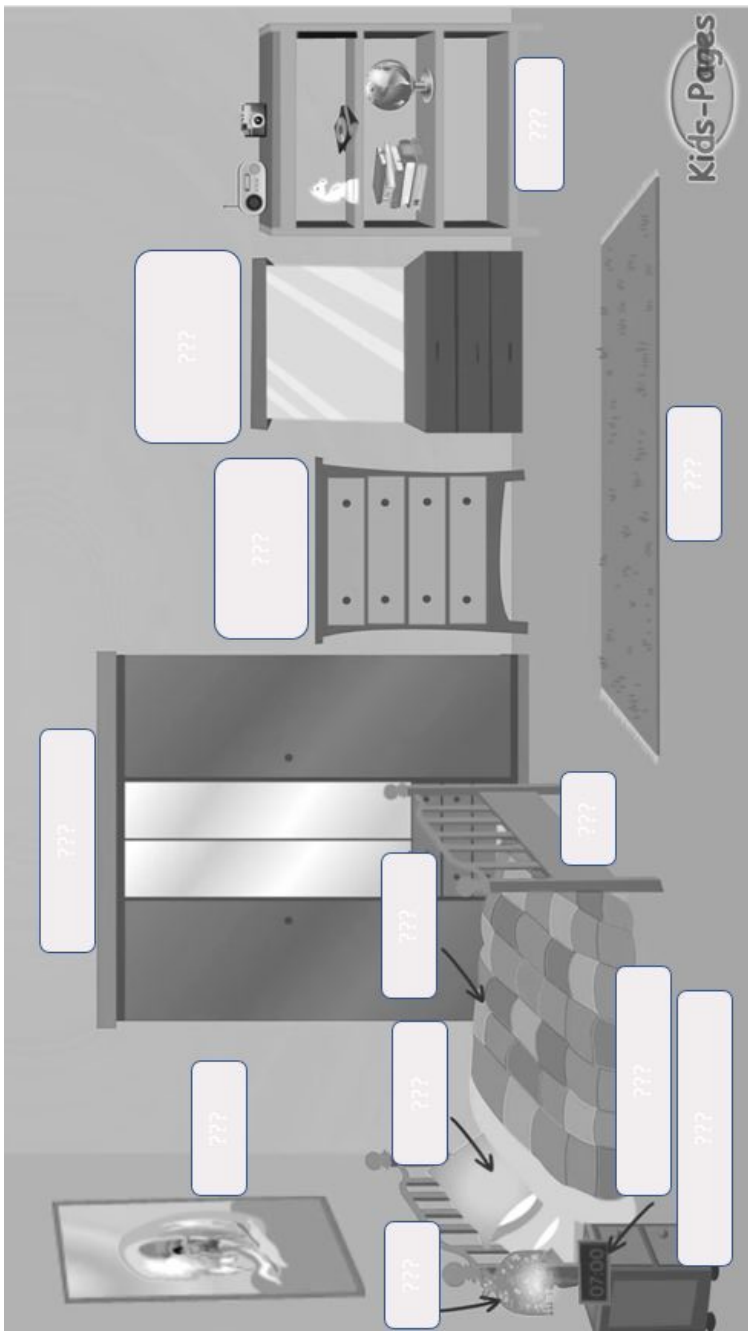
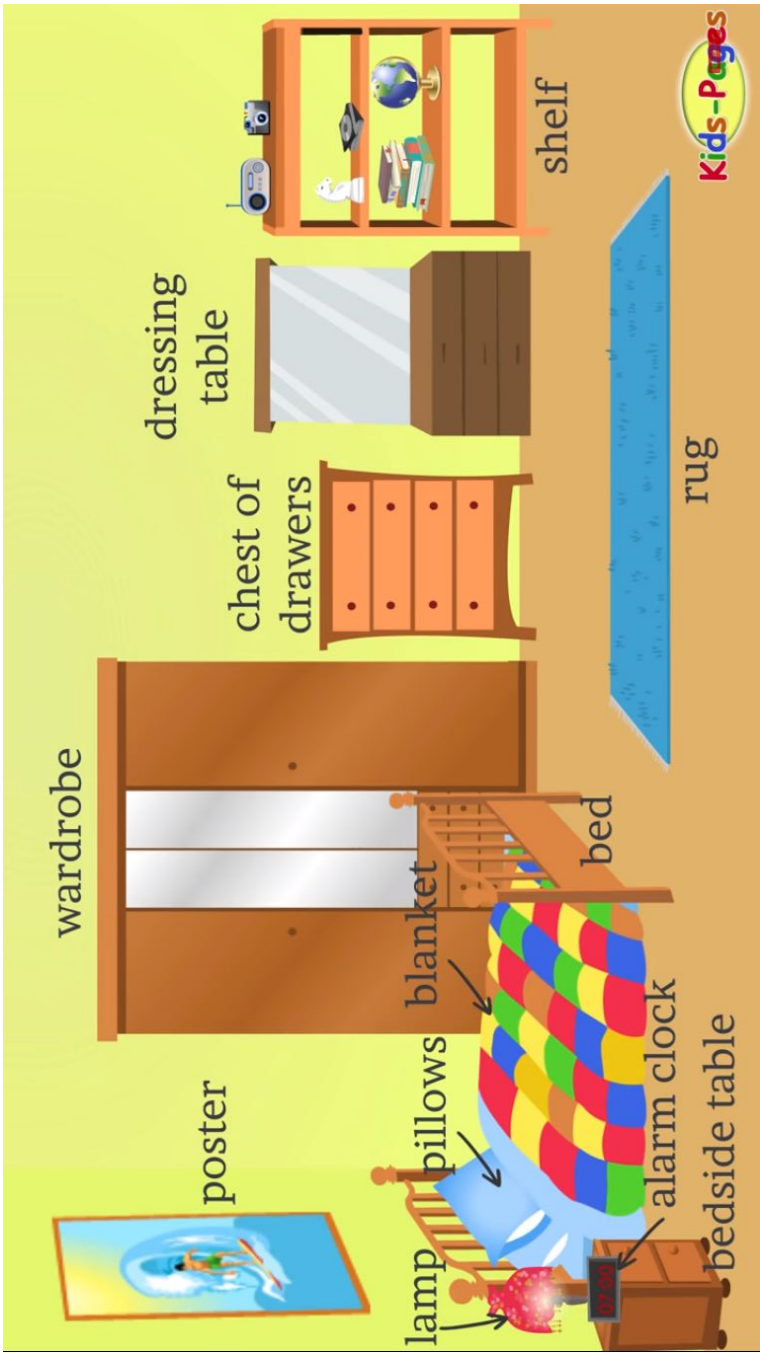



shower

lights

toothbrush

shampoo

cabinet

toothpaste

shelf

hair dryer

toilet paper

comb

hairbrush

mirror

towel

soap

sink

bathtub

plunger

toilet brush

toilet

bath mat

???

???

???

???

???

???

???

???

???

???

???

???

???

???

???

???

???

???

???

???

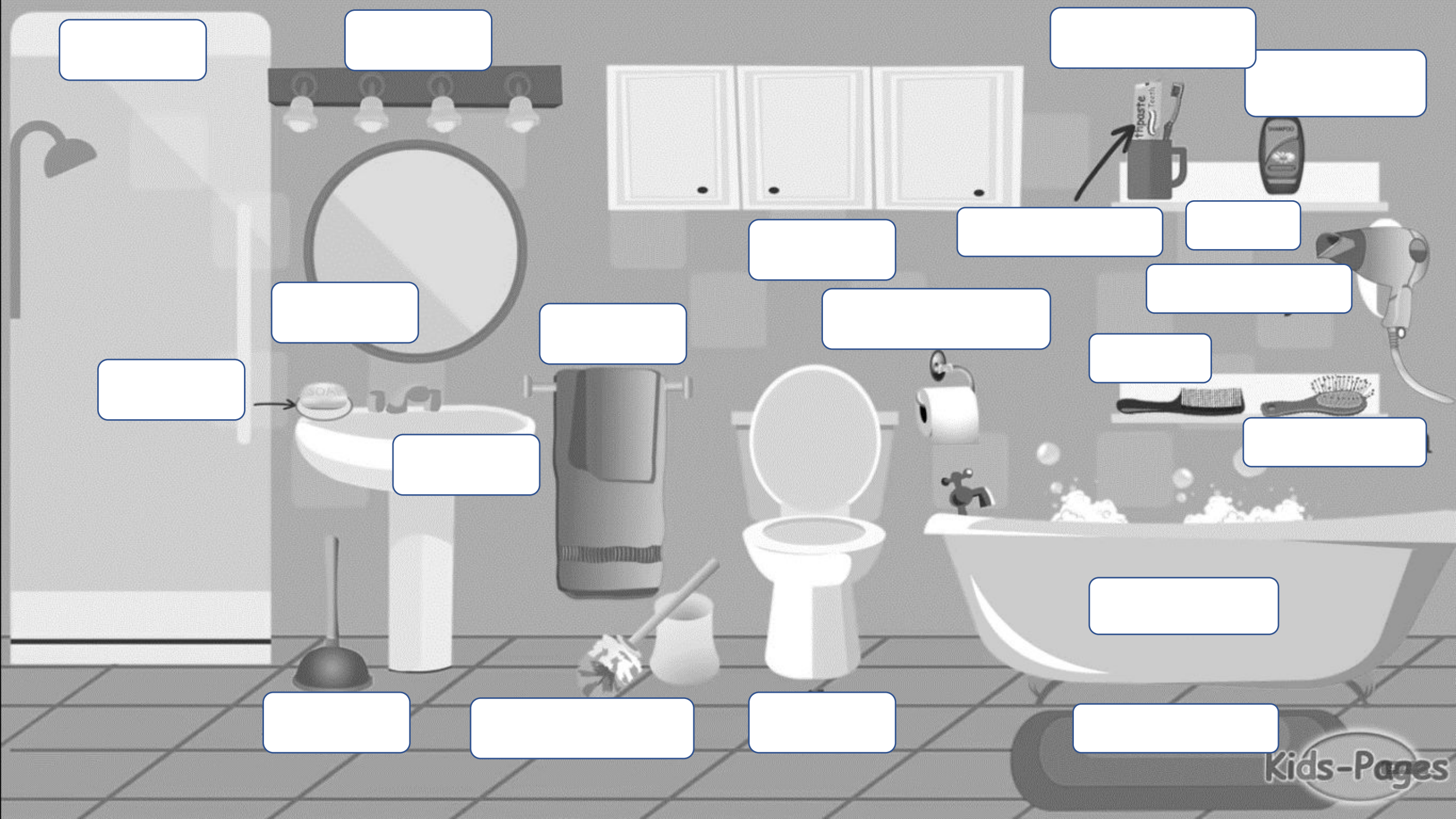

[]

[]

[]

[]

[]

[]

[]

[]

[]

[]

[]

[]

[]

[]

[]

[]

[]

[]

[]

[]

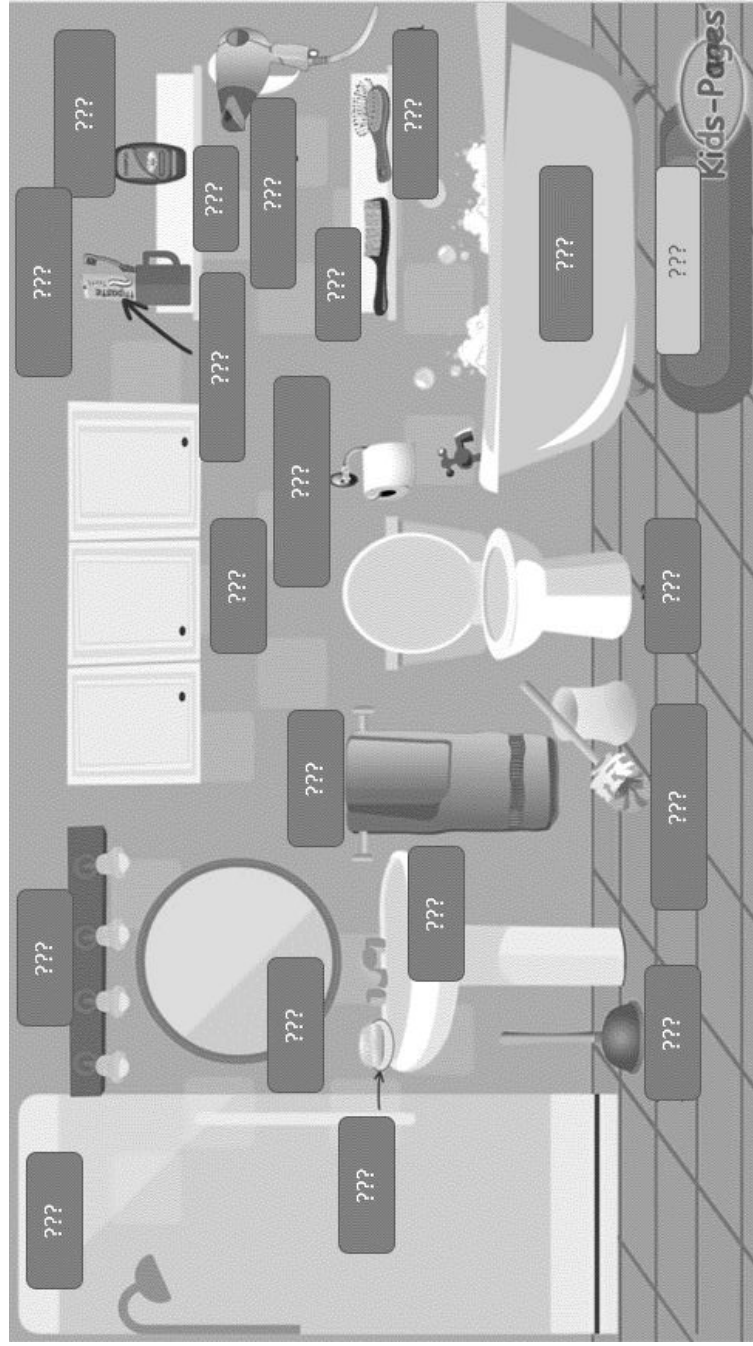
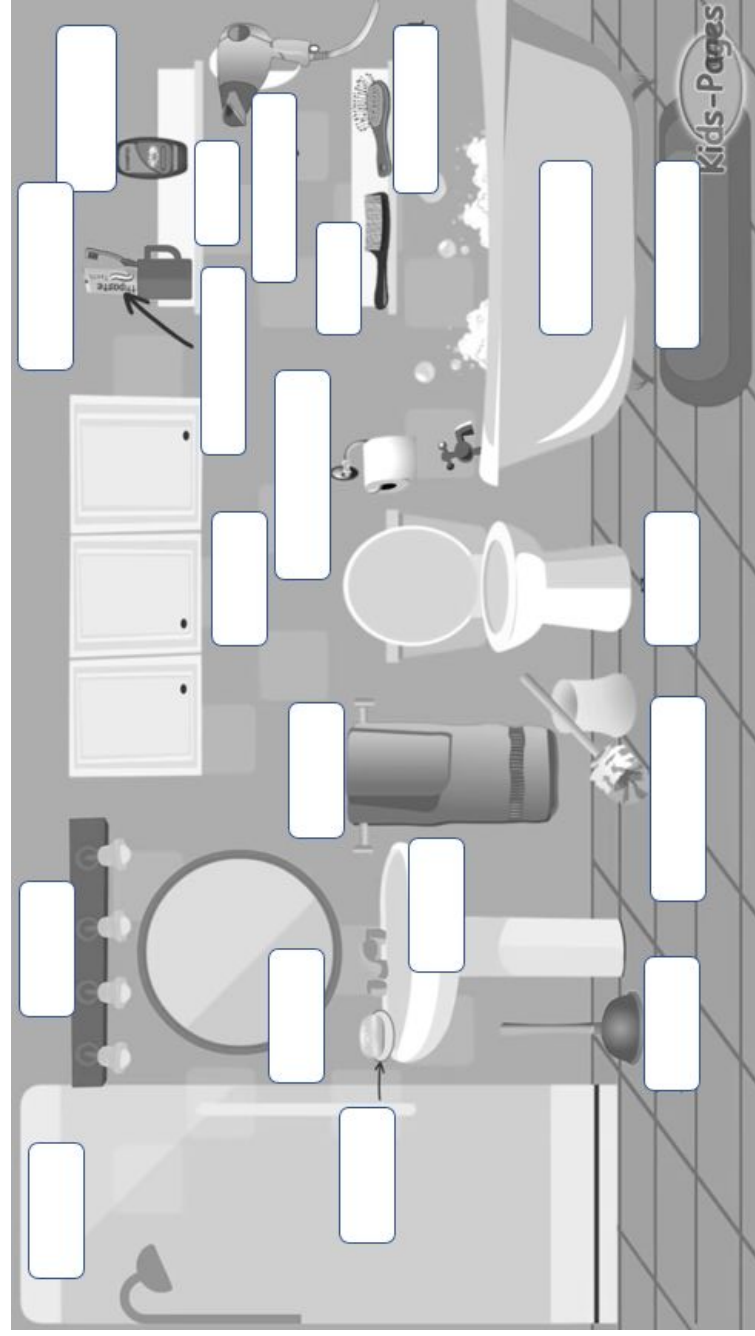

Write the correct number in front of each word:



comb ---
hairbrush ---
sink ---
towel ---
toilet ---
shower ---

toilet paper ---
laundry basket ---
toothpaste ---
toothbrush ---
bathtub ---

soap ---
mirror ---
shampoo ---
hair drier ---
tap ---

1. Introduction

2. Background

3. Methodology

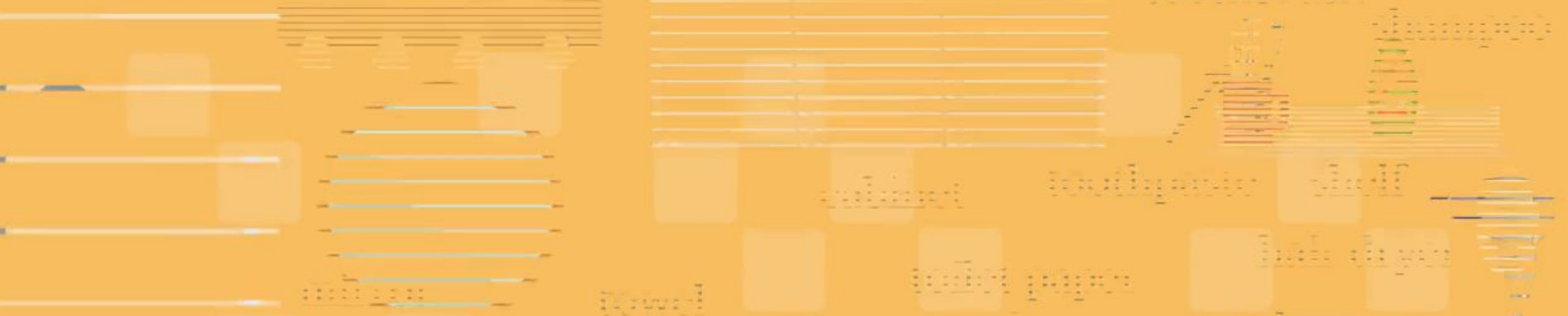

Introduction

Background

Literature Review

Research Objectives

Research Questions

Methodology

Data Collection

Data Analysis

Conclusion

References

Appendix

Bibliography

Index

Glossary



Methodology

Data Collection

Data Analysis

Conclusion

References

Appendix

Bibliography

Index





laundry

boiler

washing machine

ironing board

iron

broom

laundry basket

vacuum cleaner

dustpan

mop

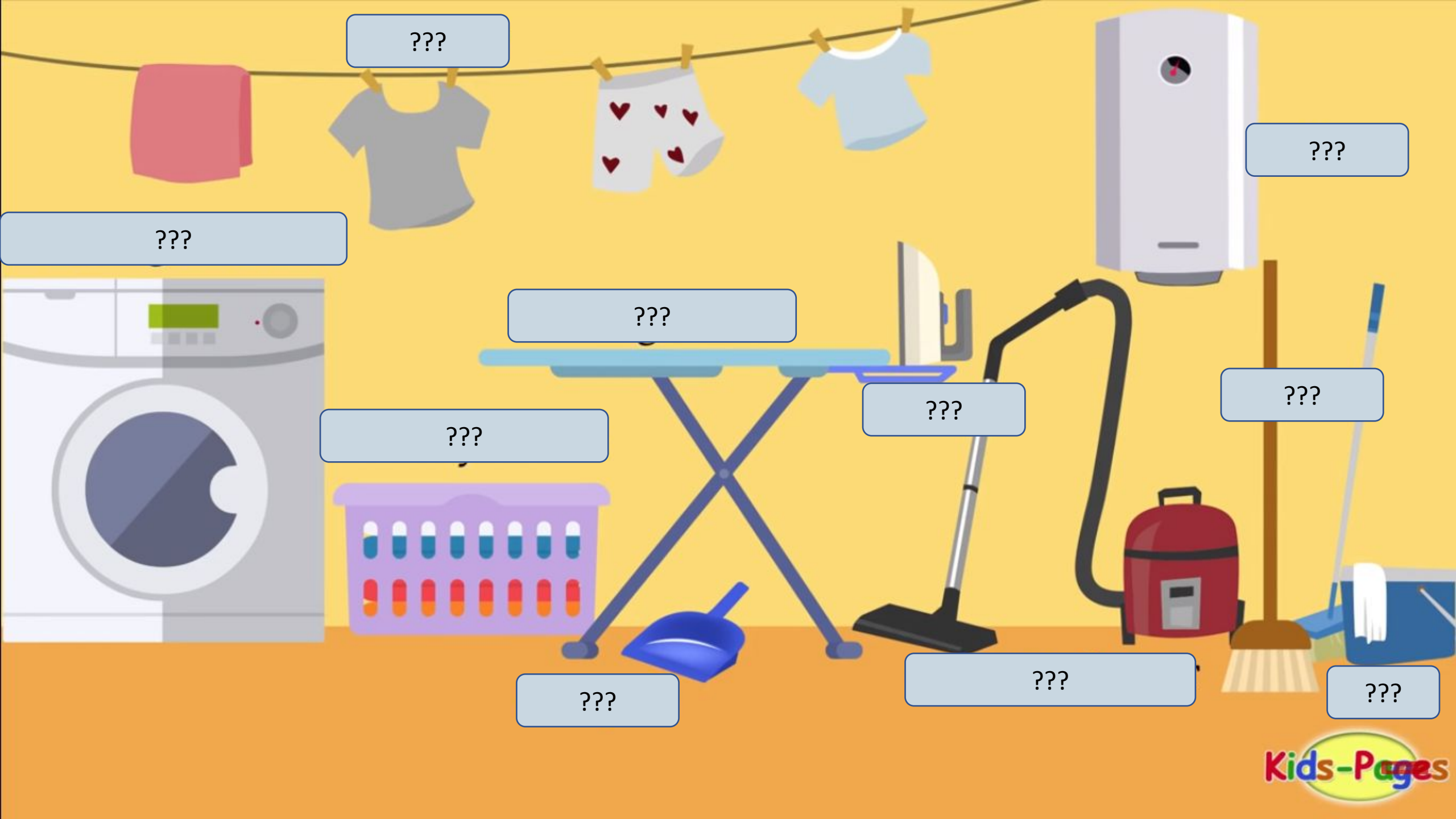

???

???

???

???

???

???

???

???

???

???

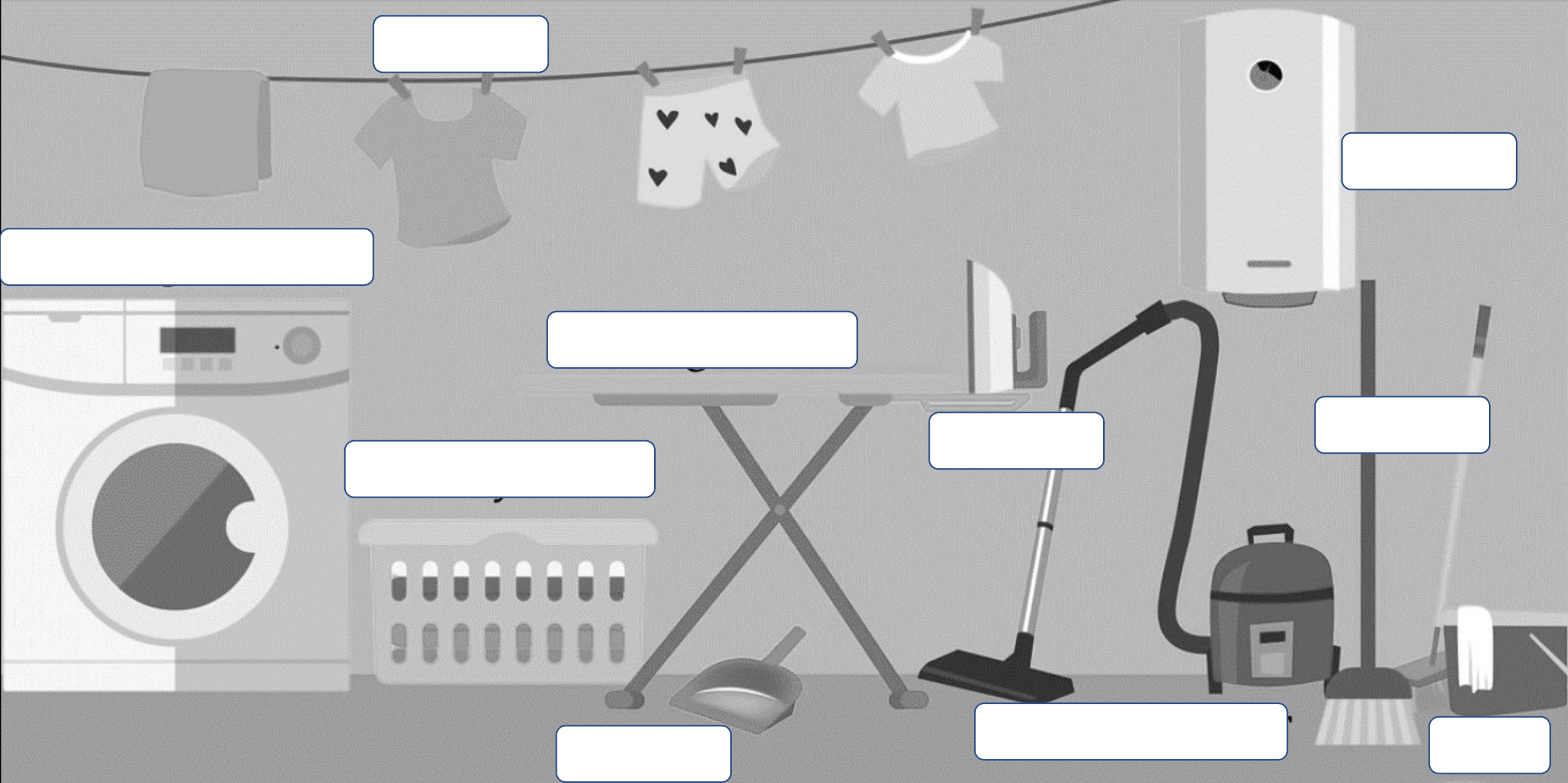

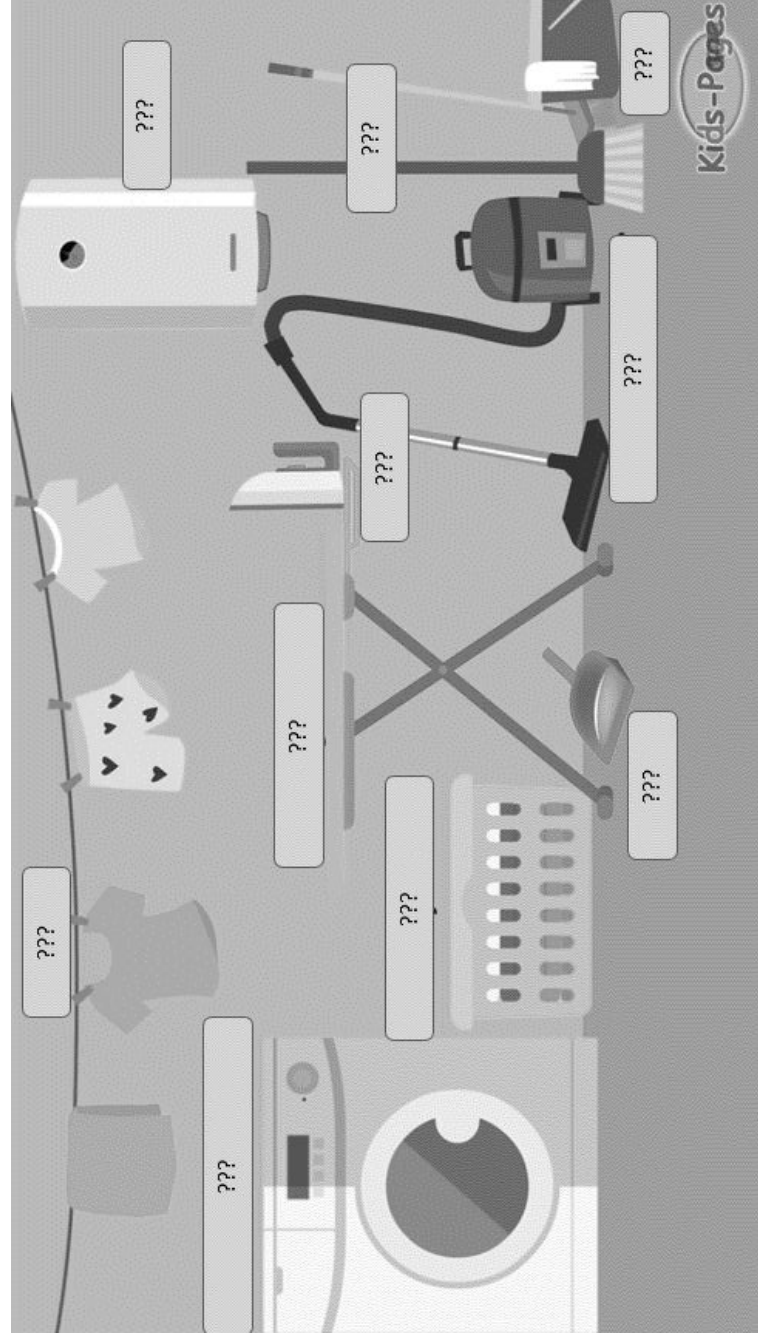
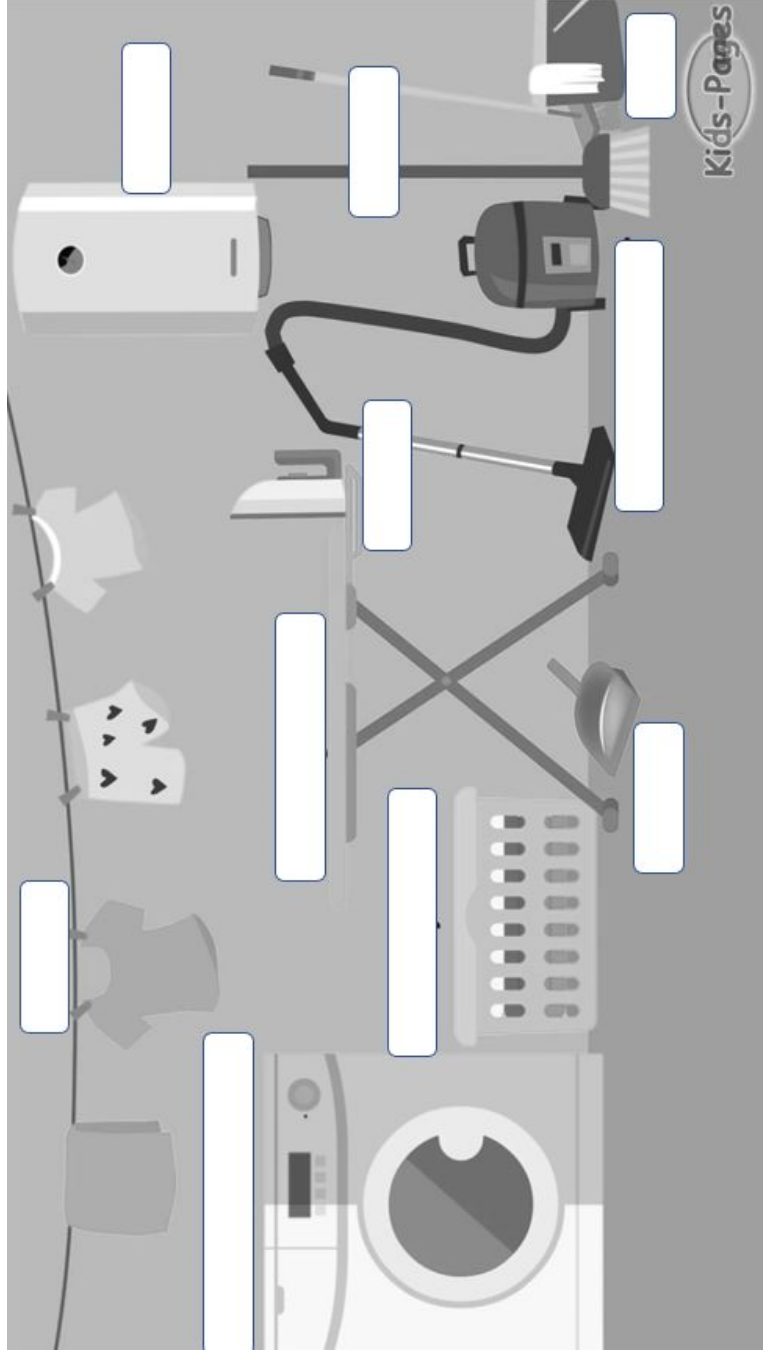
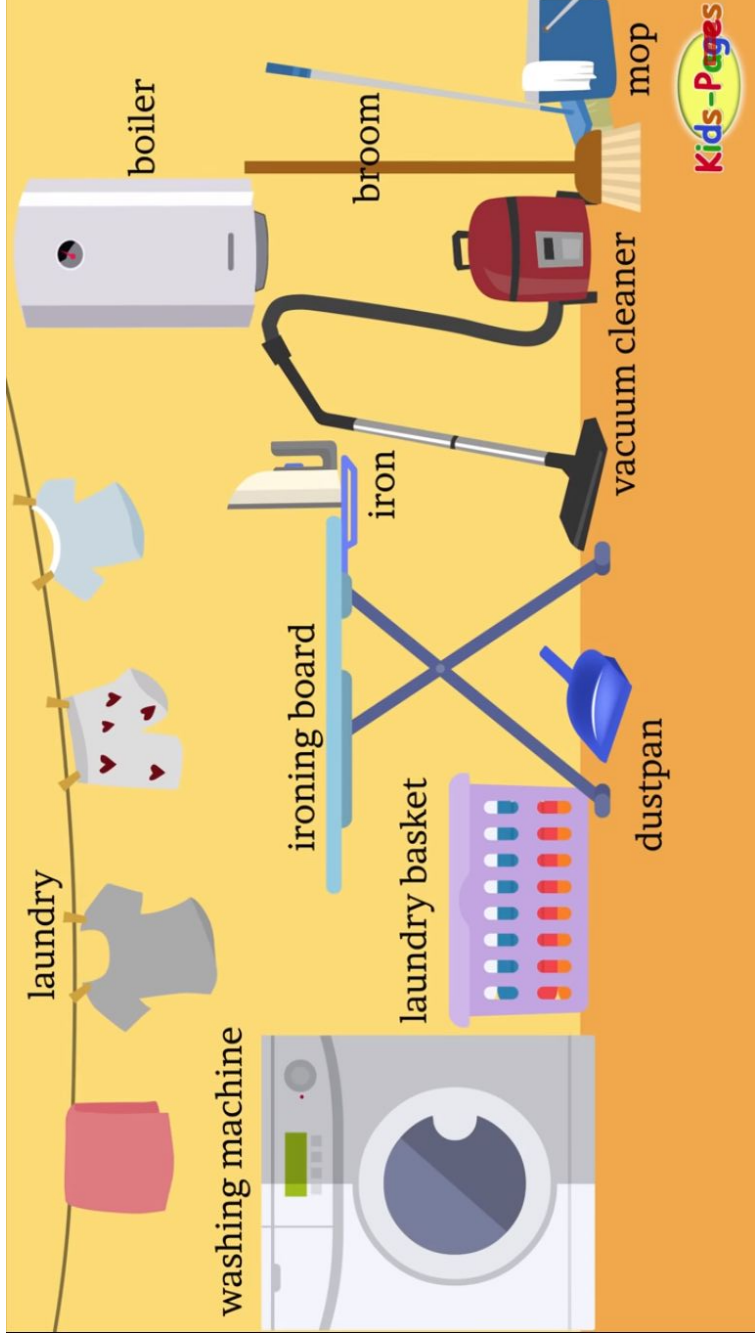

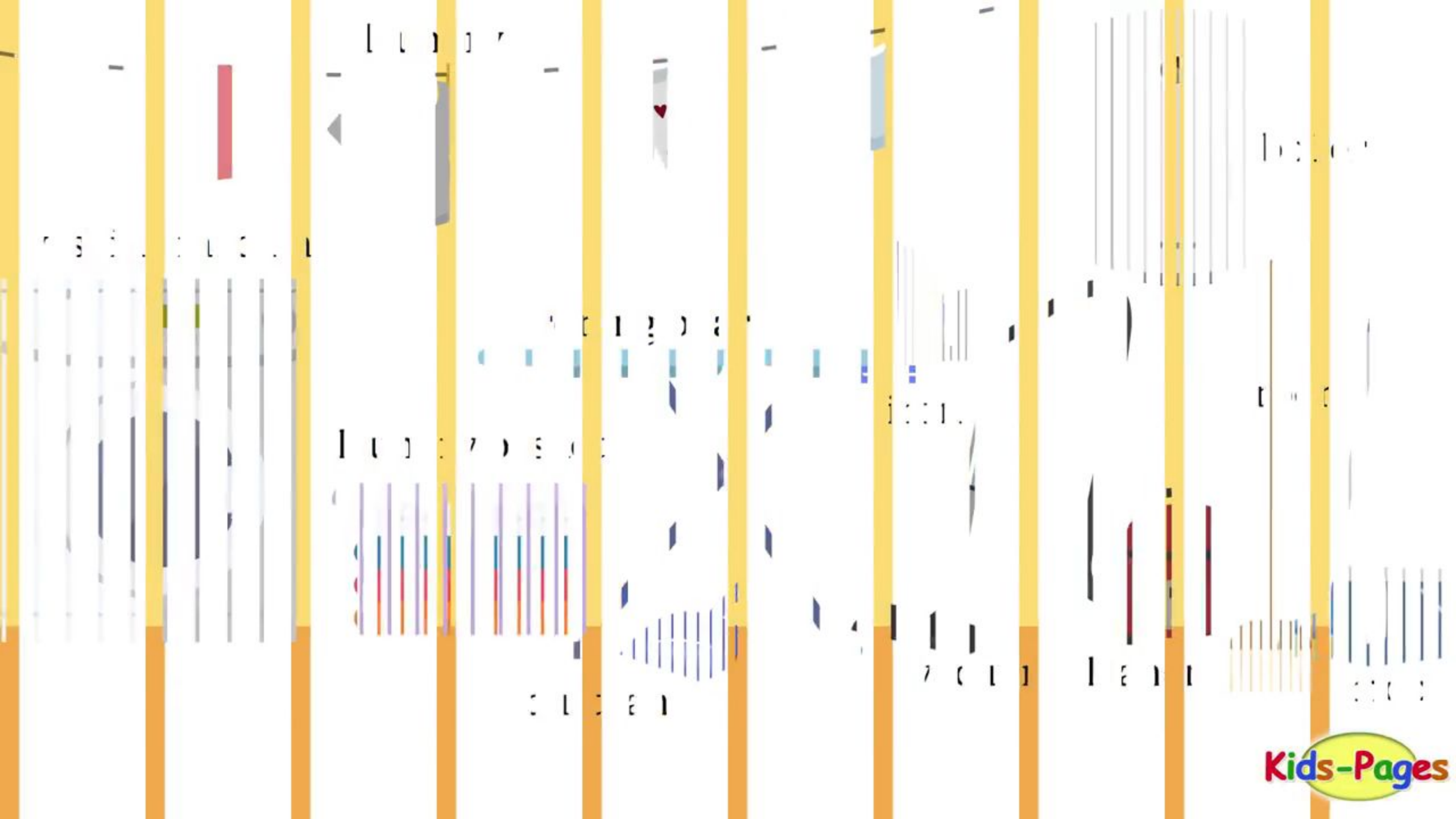

corkboard

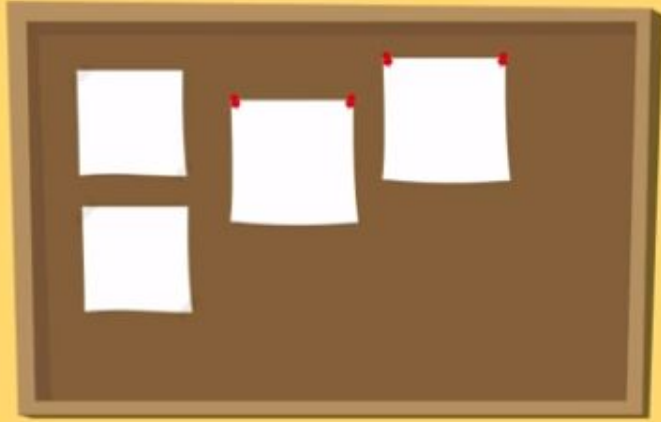

calendar



books



shelf

clipboard



printer



drawers

chair

monitor

desk lamp

laptop

file racks

folder

keyboard



desk

trash bin



???

???

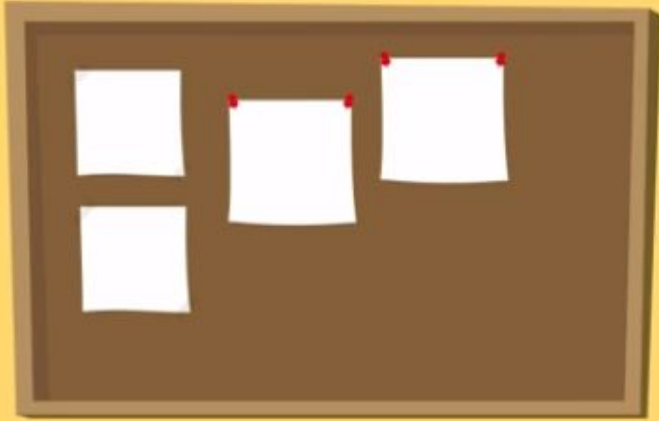

???

???



???

???



???

???

???

???

???

file racks

???

???

???



???

???



[]

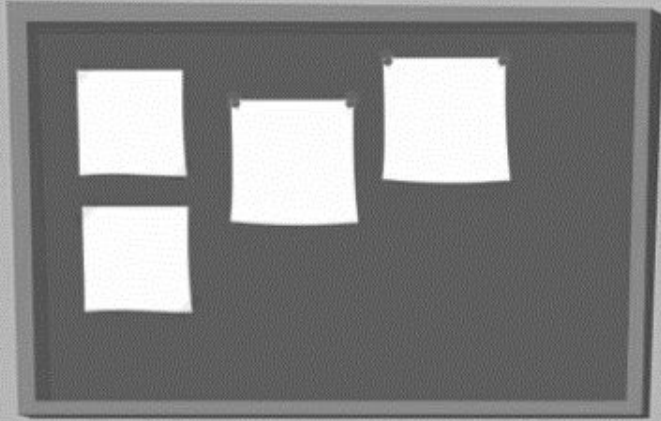

[]



[]

[]

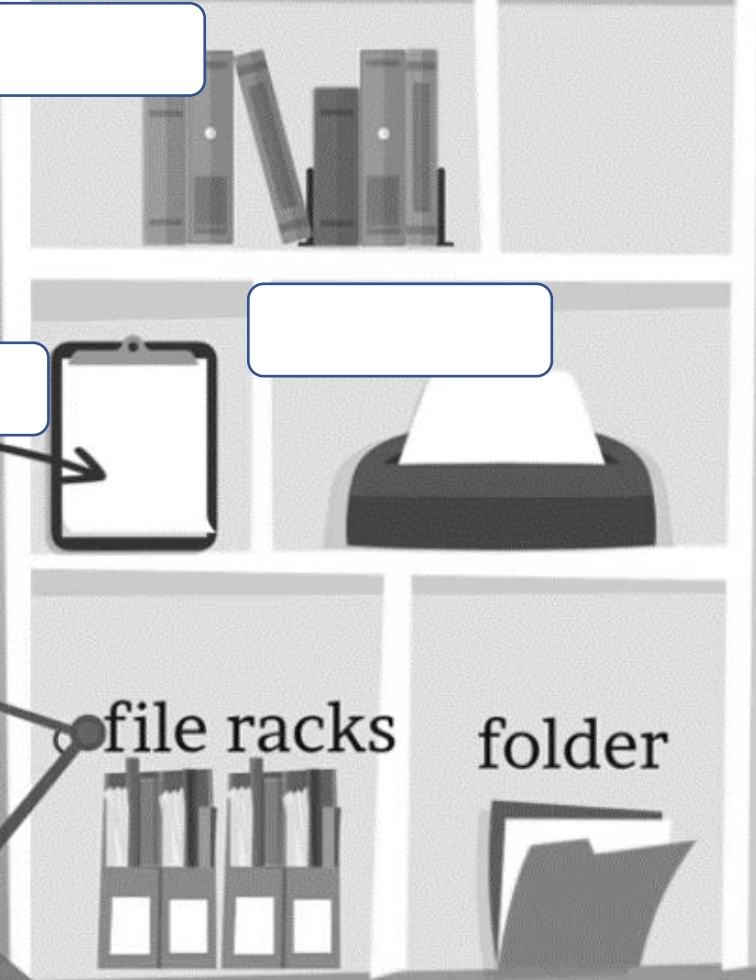

[]

[]



[]

[]

[]

[]

[]

file racks

folder

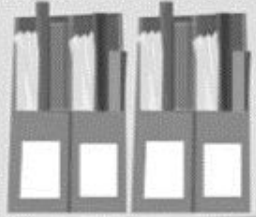

[]

[]

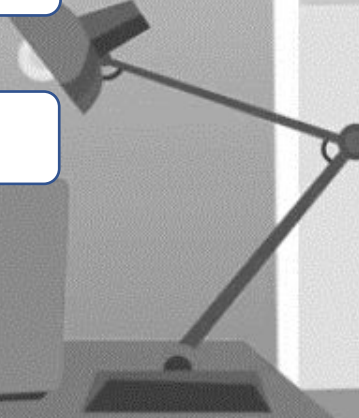
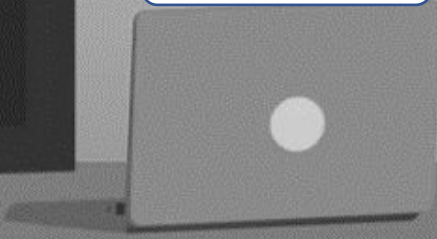
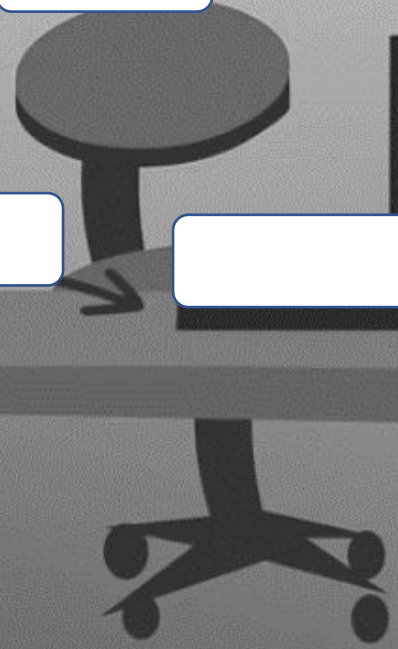
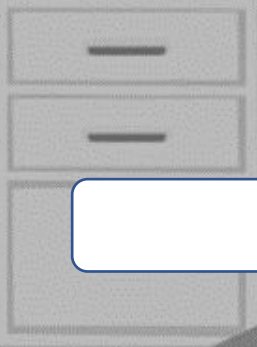

[]

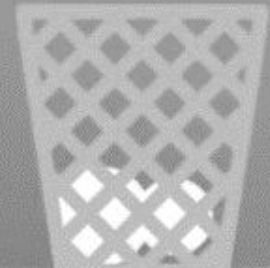

[]

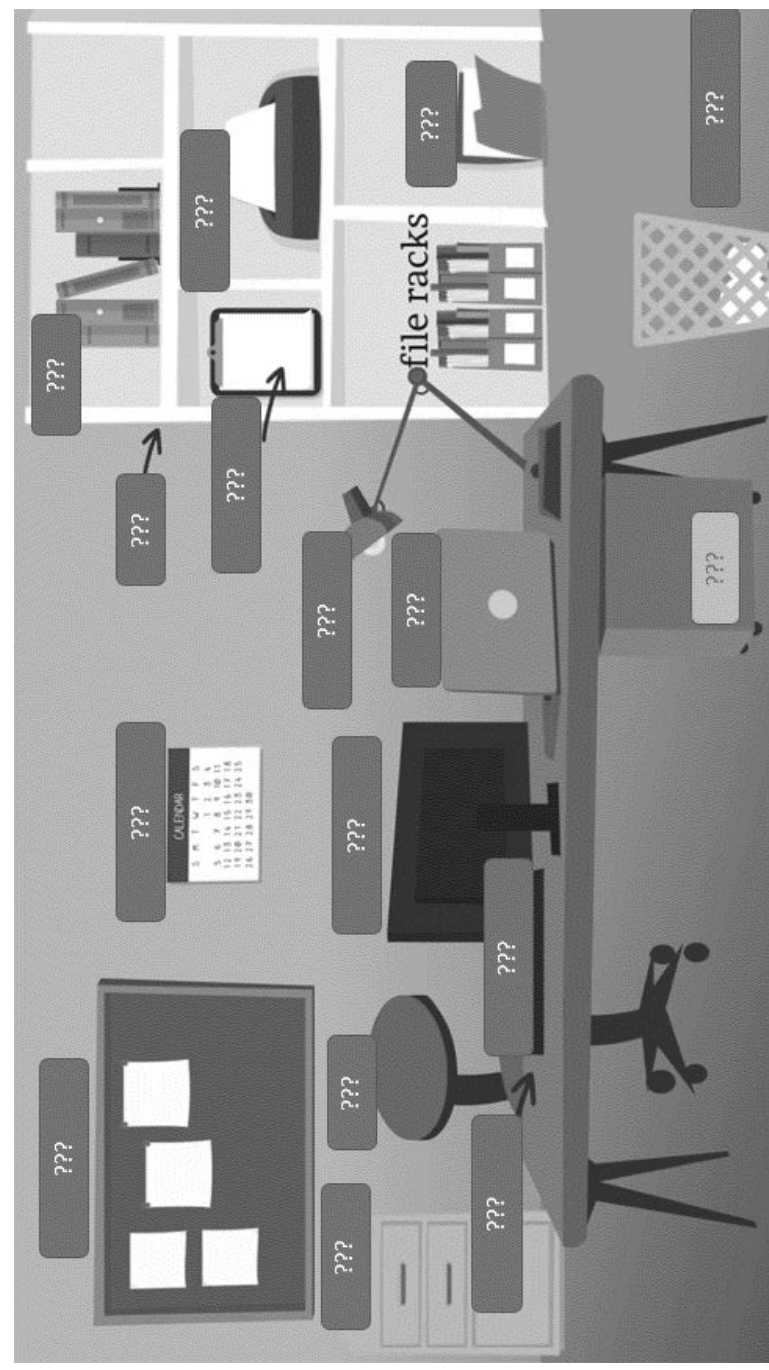
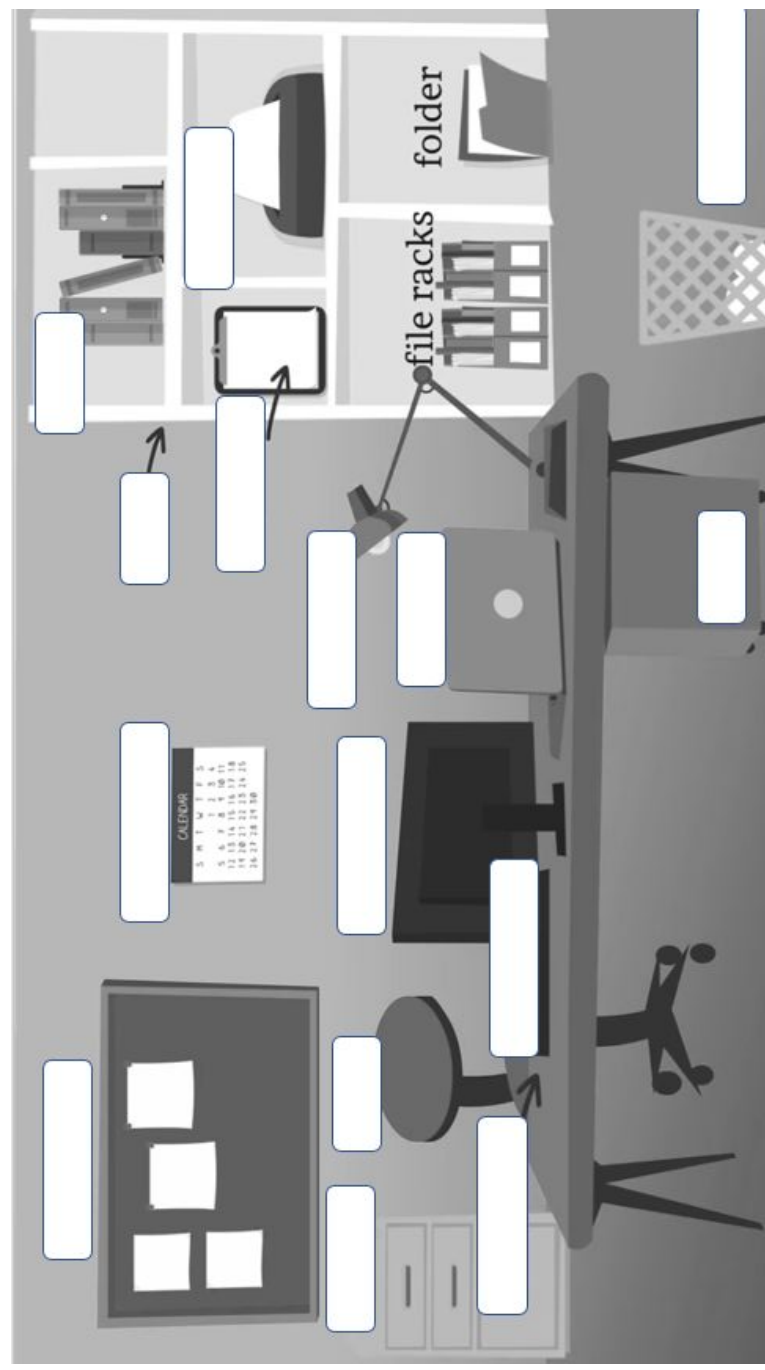
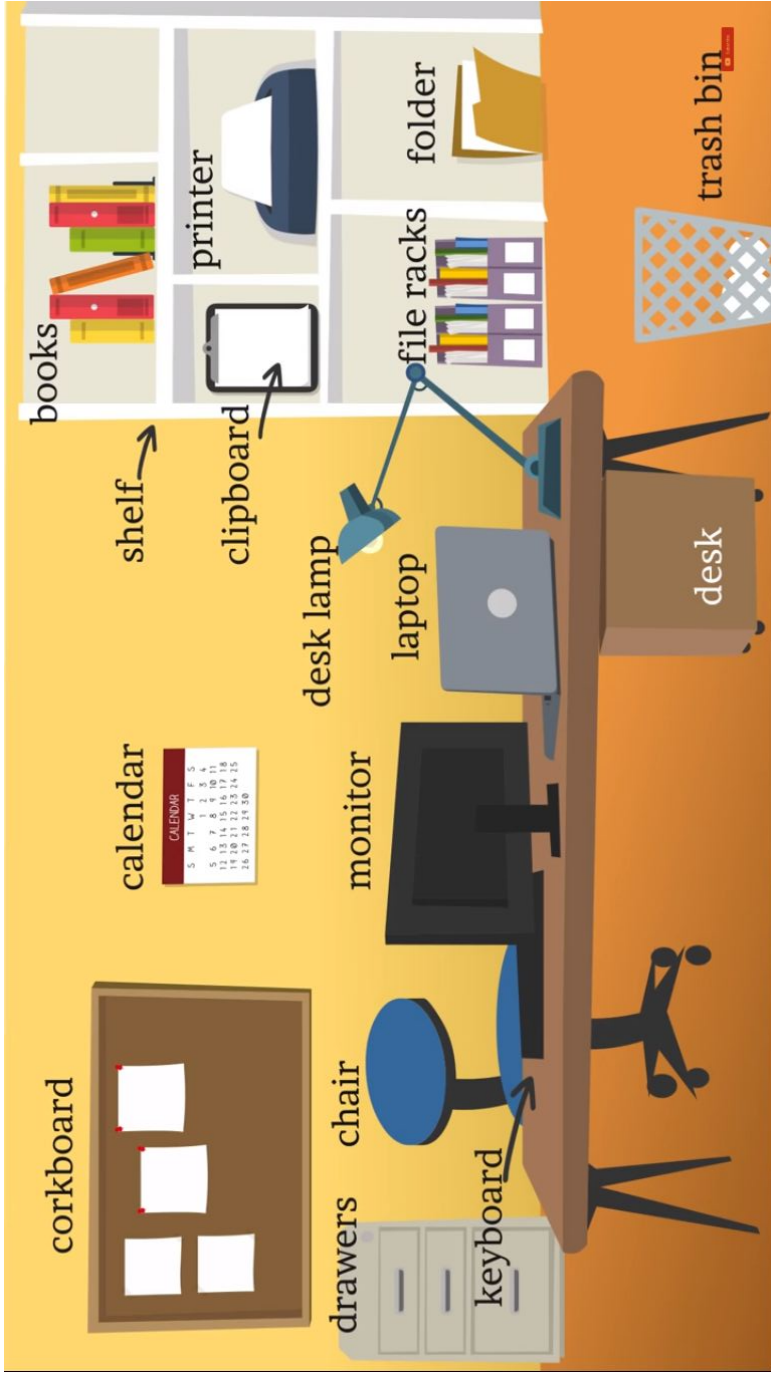



Kitchen



range hood

cabinet

refrigerator

kettle

pot

cup

chopping board

pans

glass hanger

microwave

sink

stove

dishwasher

knives stand

oven

dishes

chair

salt shaker

counter

blender

glass

napkin

fork

plate

knife

spoon

table

???

???

???

???

???

???

???

???

???

???

???

???

???

???

???

???

???

???

???

???

???

???

???

???

???

???

???



[]

[]

[]

[]

[]

[]

[]

[]

[]

[]

[]

[]

[]

[]

[]

[]

[]

[]

[]

[]

[]

[]

[]

[]

[]

[]

[]

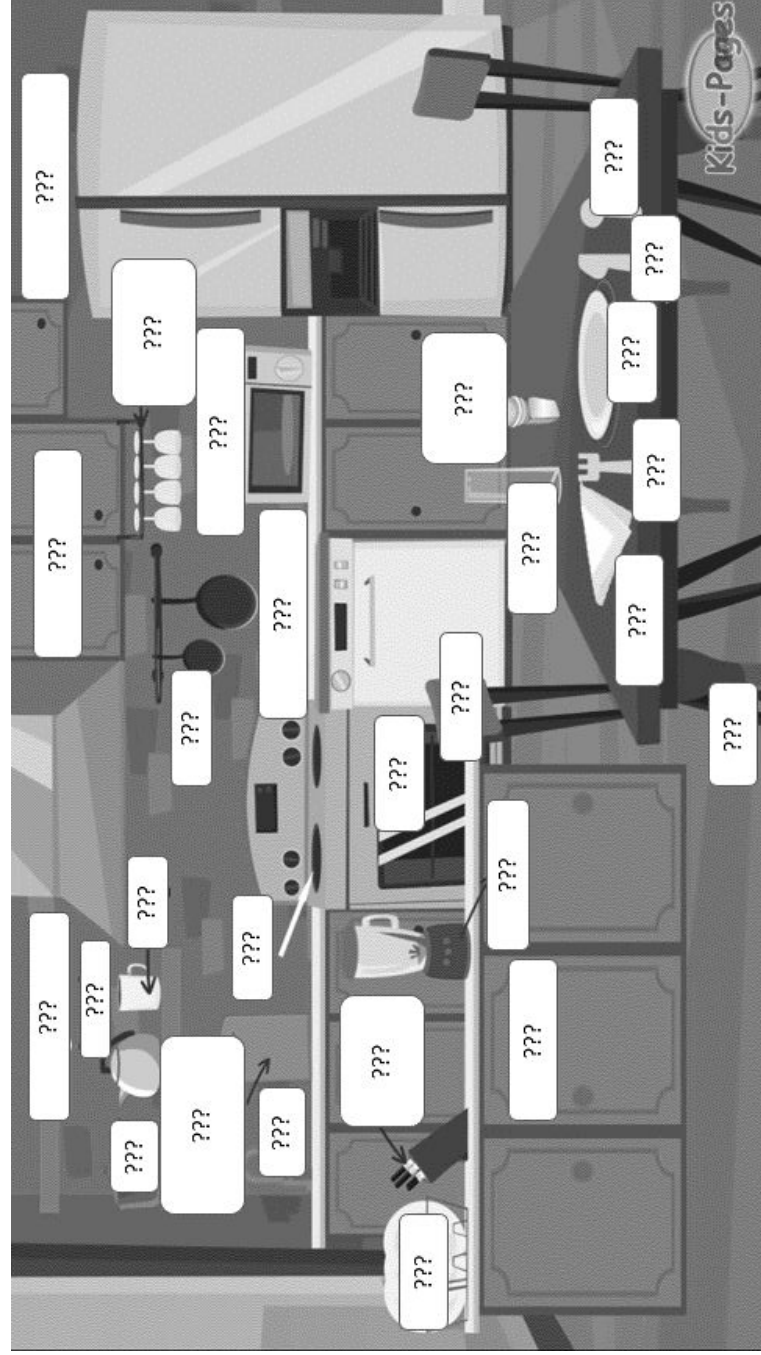
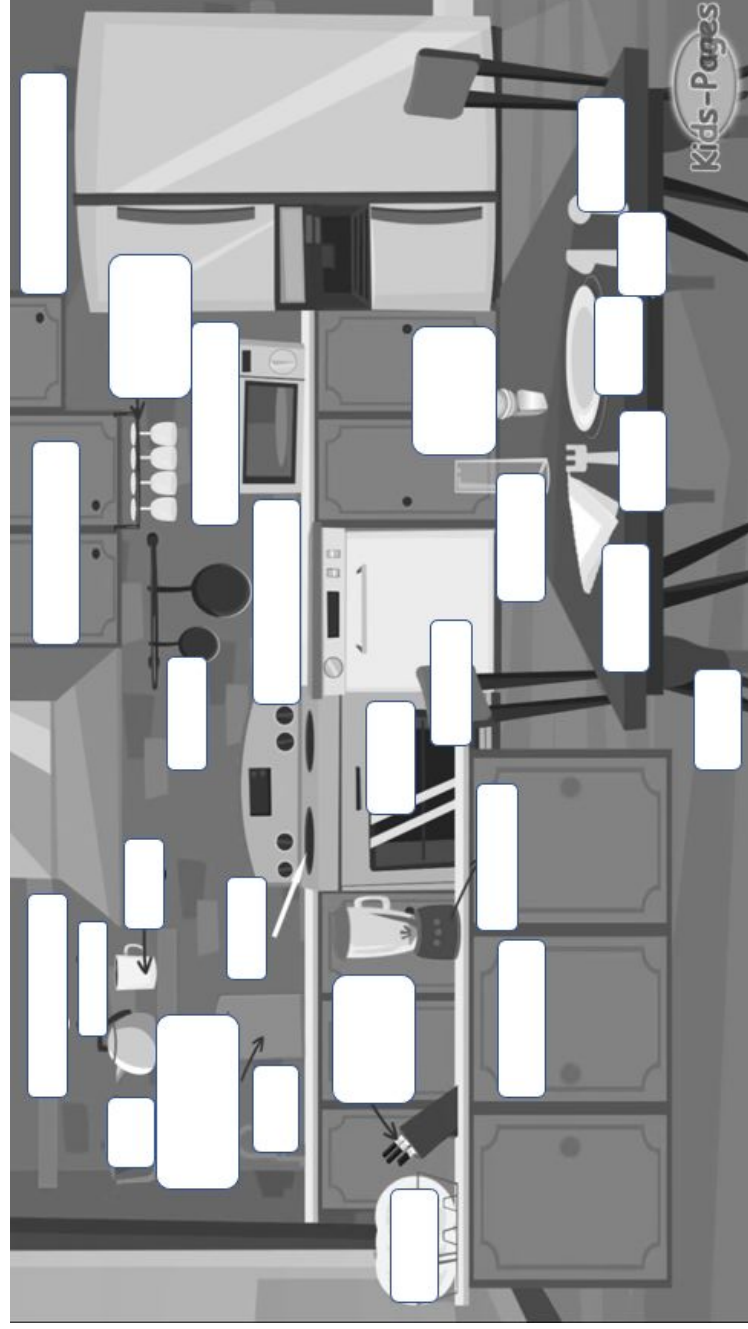
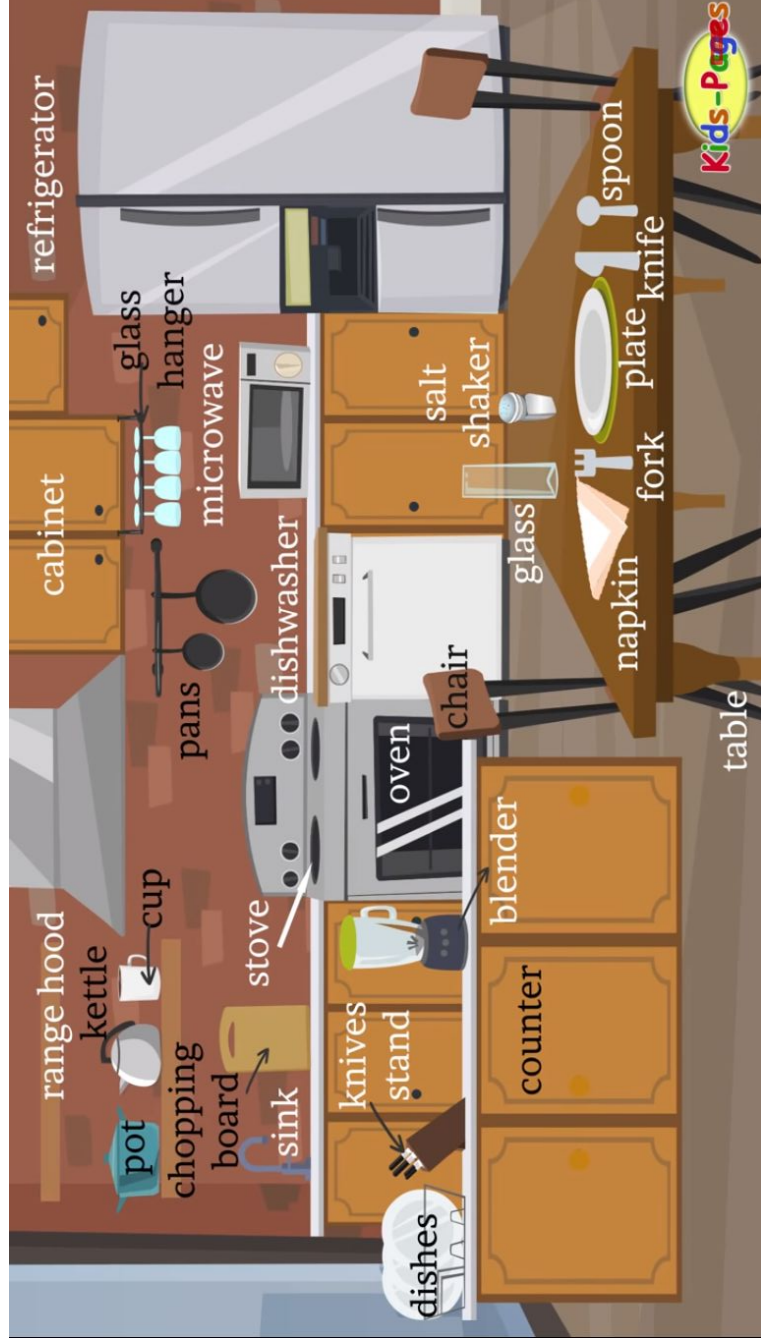



range hood

cabinet

refrigerator

kettle

pot

cup

chopping
board

pans

glass
hanger

microwave

sink

stove

dishwasher

knives
stand

oven

dishes

chair

salt
shaker

counter

blender

glass

napkin

fork

plate

knife

spoon

table



Furniture Fill In



Furniture - There Is / There Are



House Parts 1



House Parts 2



Bathroom Matching



Bedroom And Prepositions



Kitchen - Matching



Furniture - There Is / There Are B&W



House Bedroom B & W



House Parts B & W



Furniture Fill In B&W



House Parts 2 B&W



Bathroom Matching B&W



Kitchen Matching B&W



Household Chores