

# Устройство капитанской гички













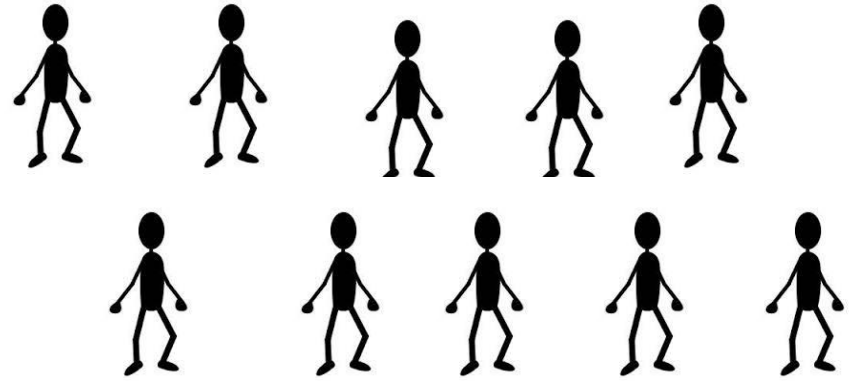













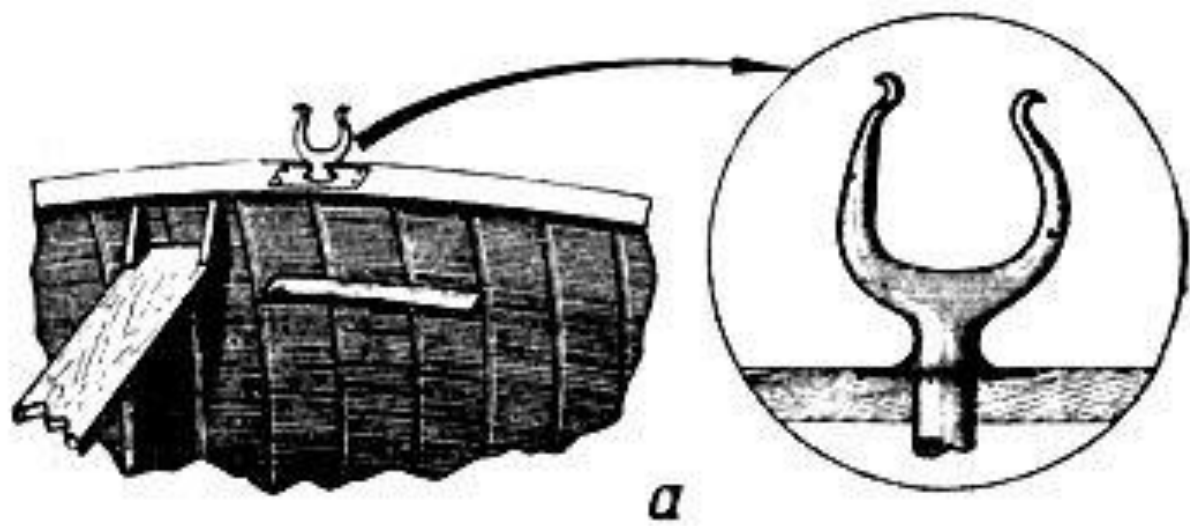







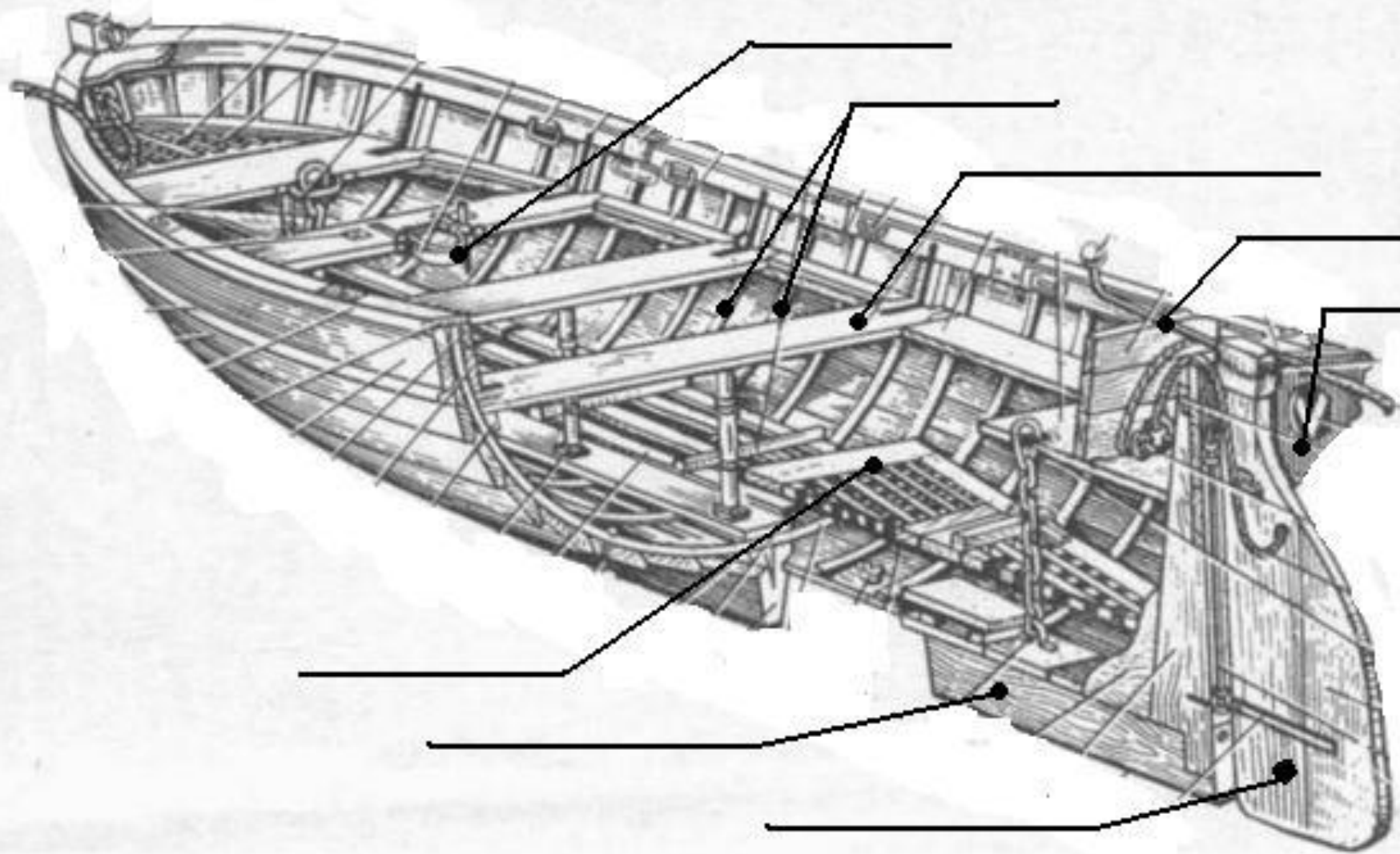



**КИЛЬ**  
**ШПАНГОУТЫ**  
**ШПАЦИЯ**



-НОС

-корма

-мидель (от англ. “middle”)

-правый и левый борта

- диаметральный плоскость

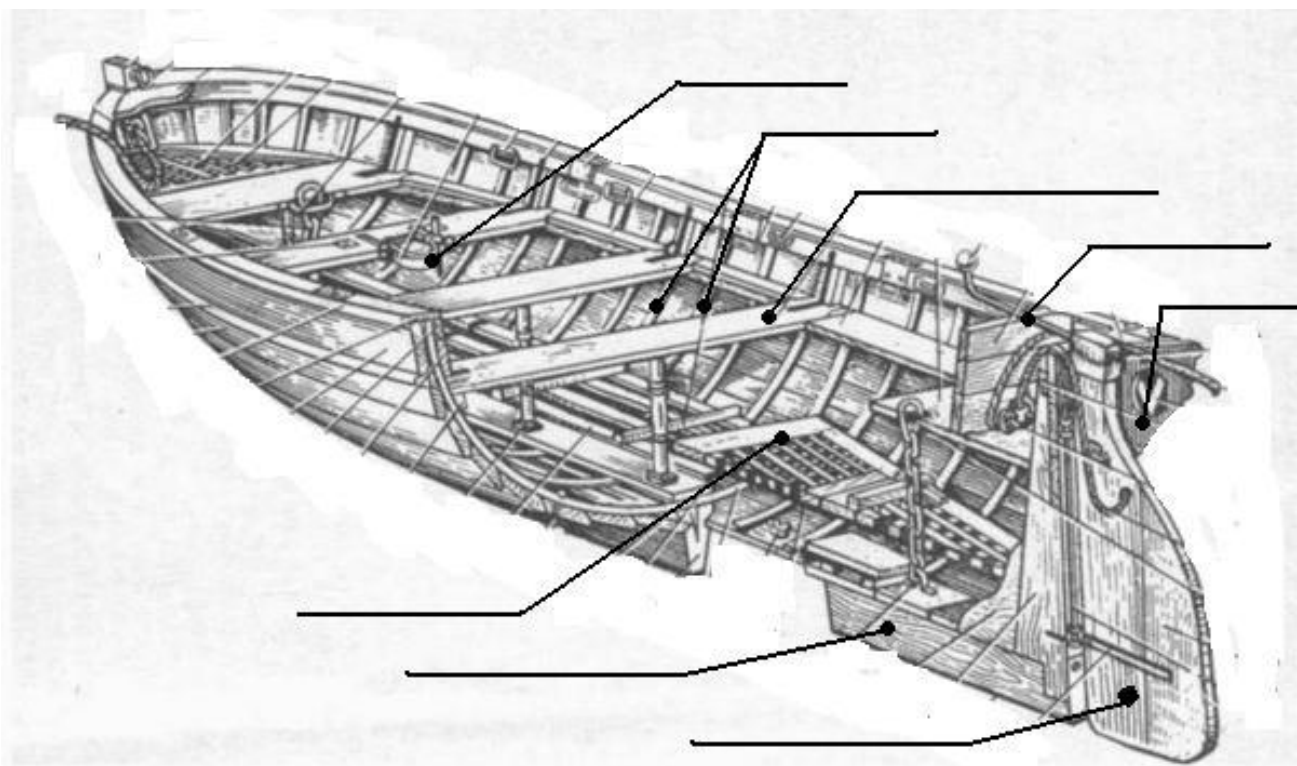



транец





пайолы

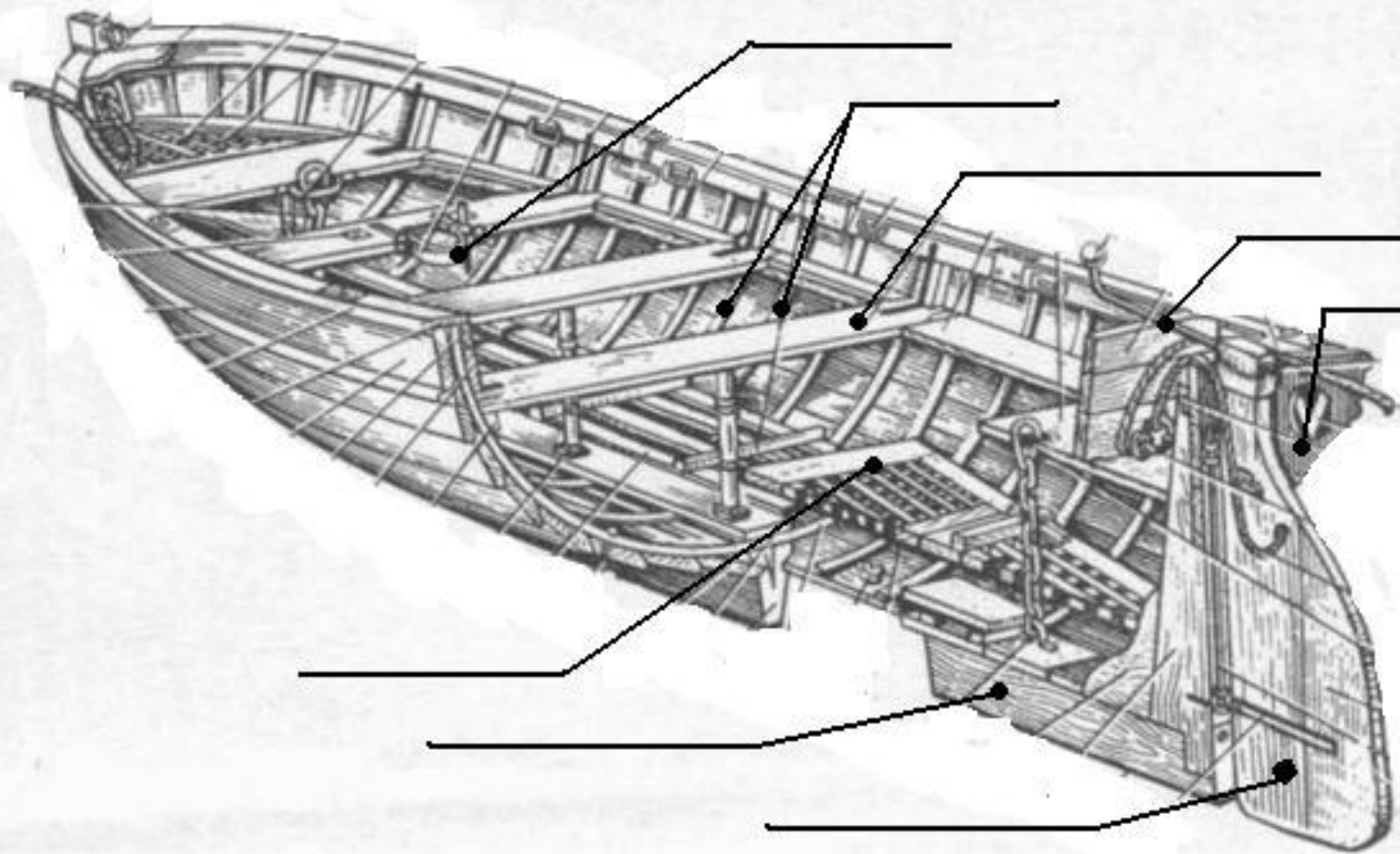





перо руля  
румпель





банка  
пиллерс (от англ. «pillar» - столб)



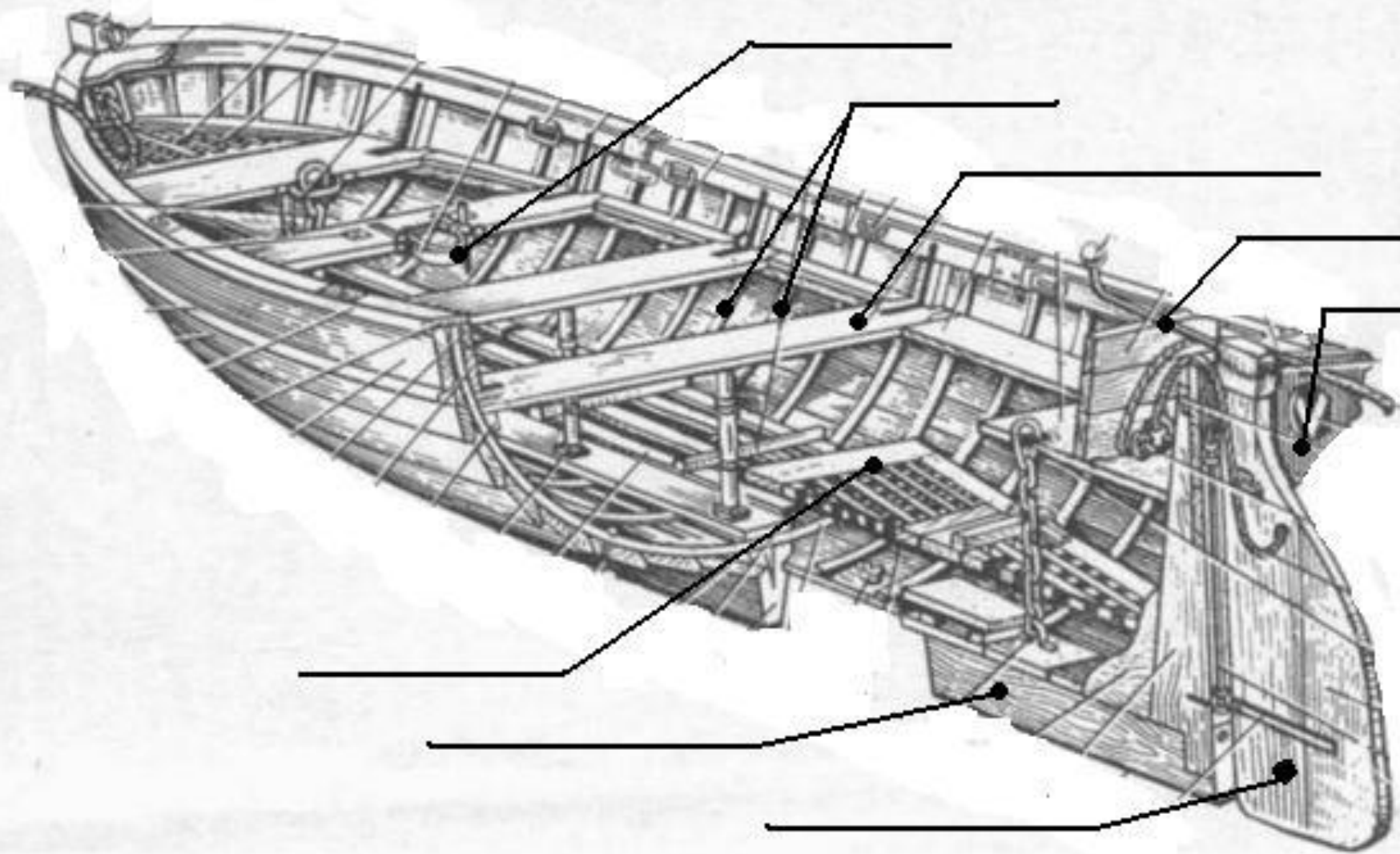

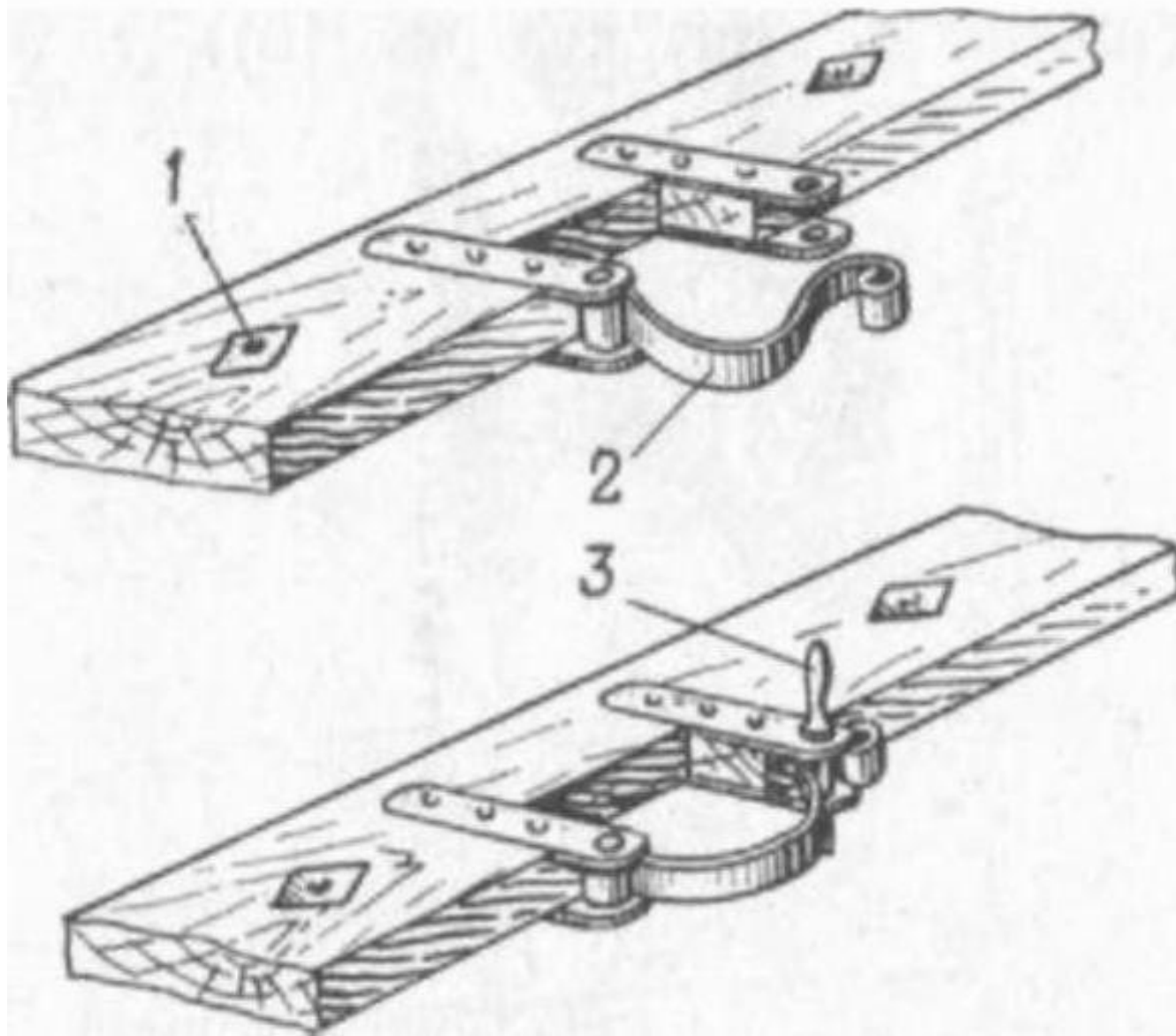

наметка





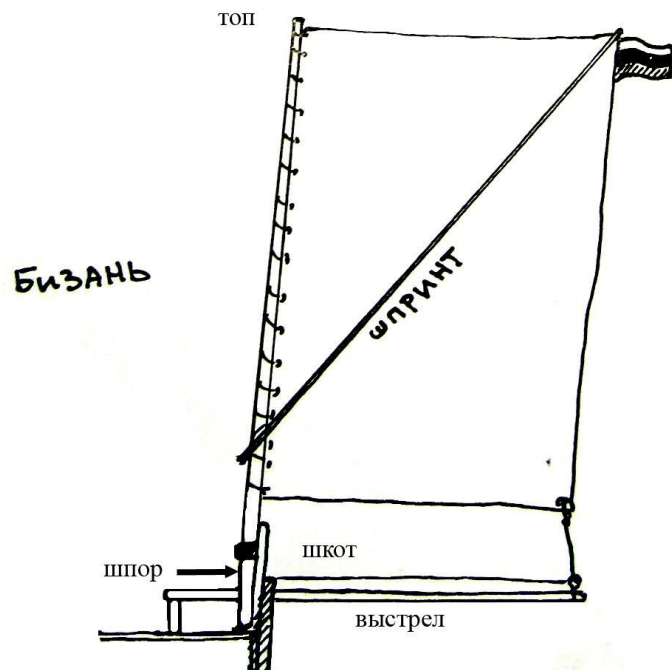
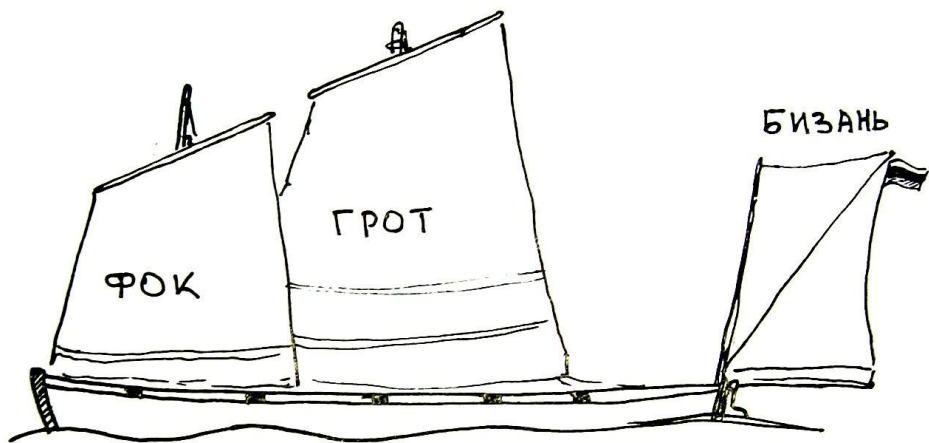



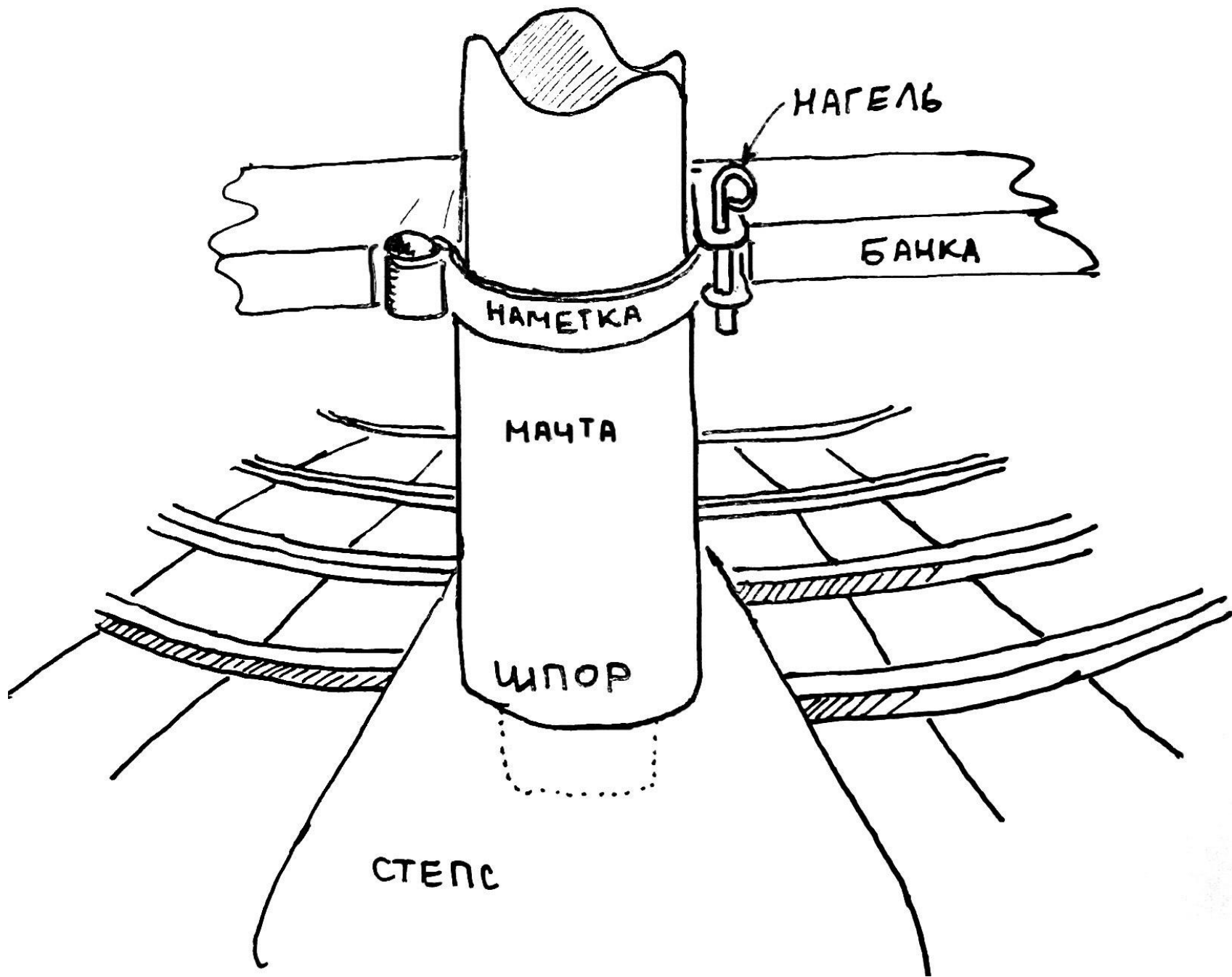

- фок-мачта (от англ “for”- «вперед», «передний»)
- грот-мачта
- бизань-мачта (англ. “mizzen”)







  
BANK BRI

Jawa Pos

MERDEKA 

MERATUS

peëk







- ШПРИНТОВ  
- ВЫСТРЕЛ







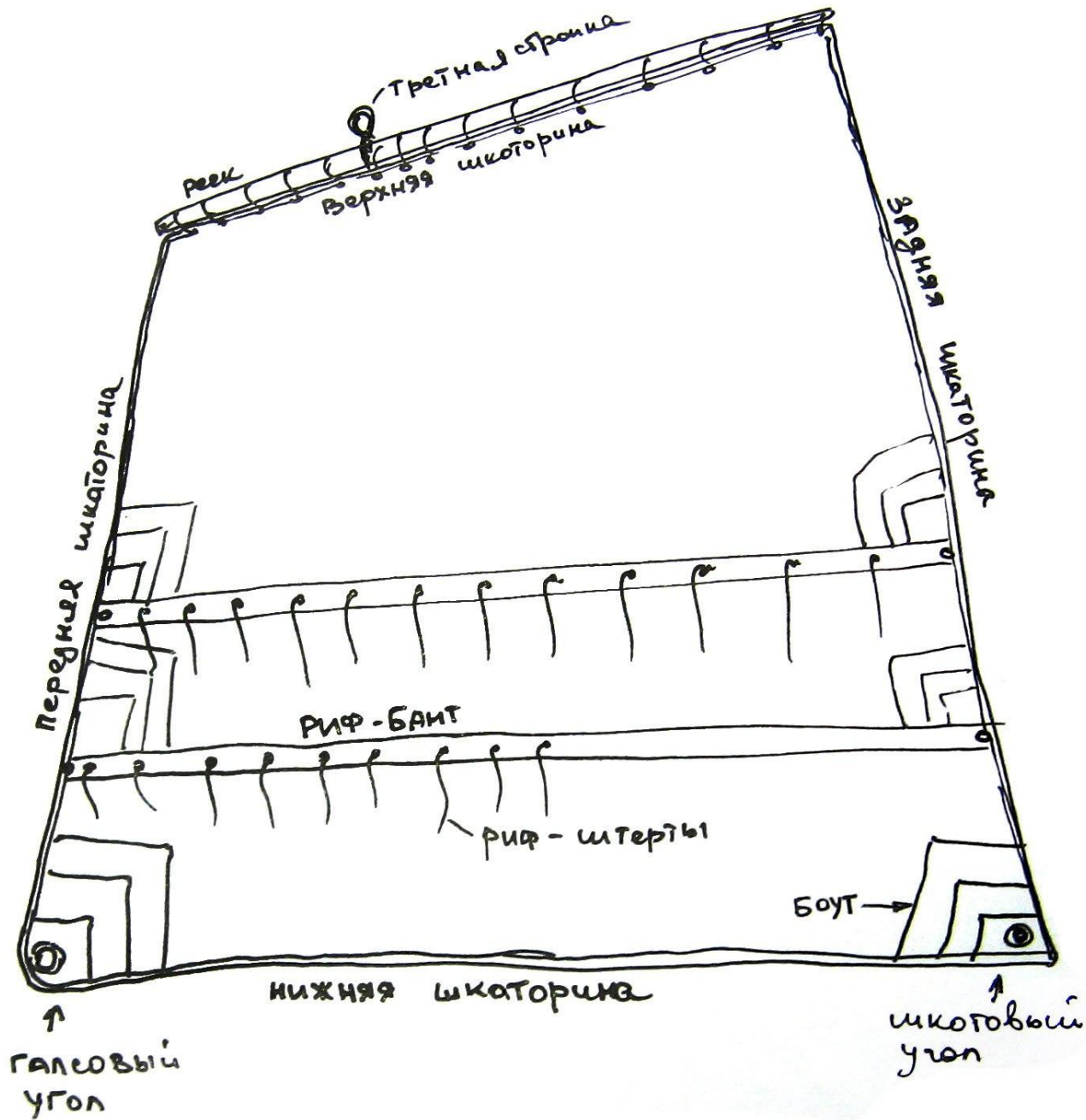







- фал
- усилитель фала
- ракс-бугель



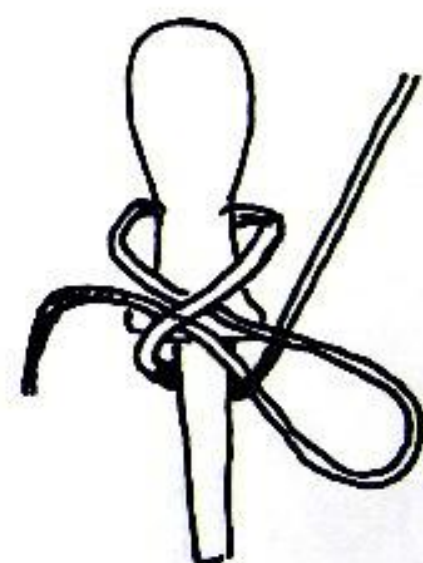
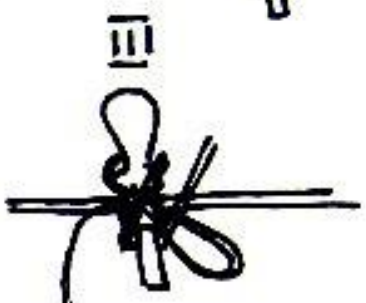
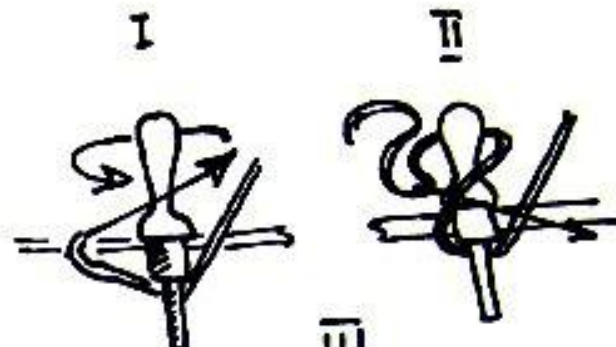
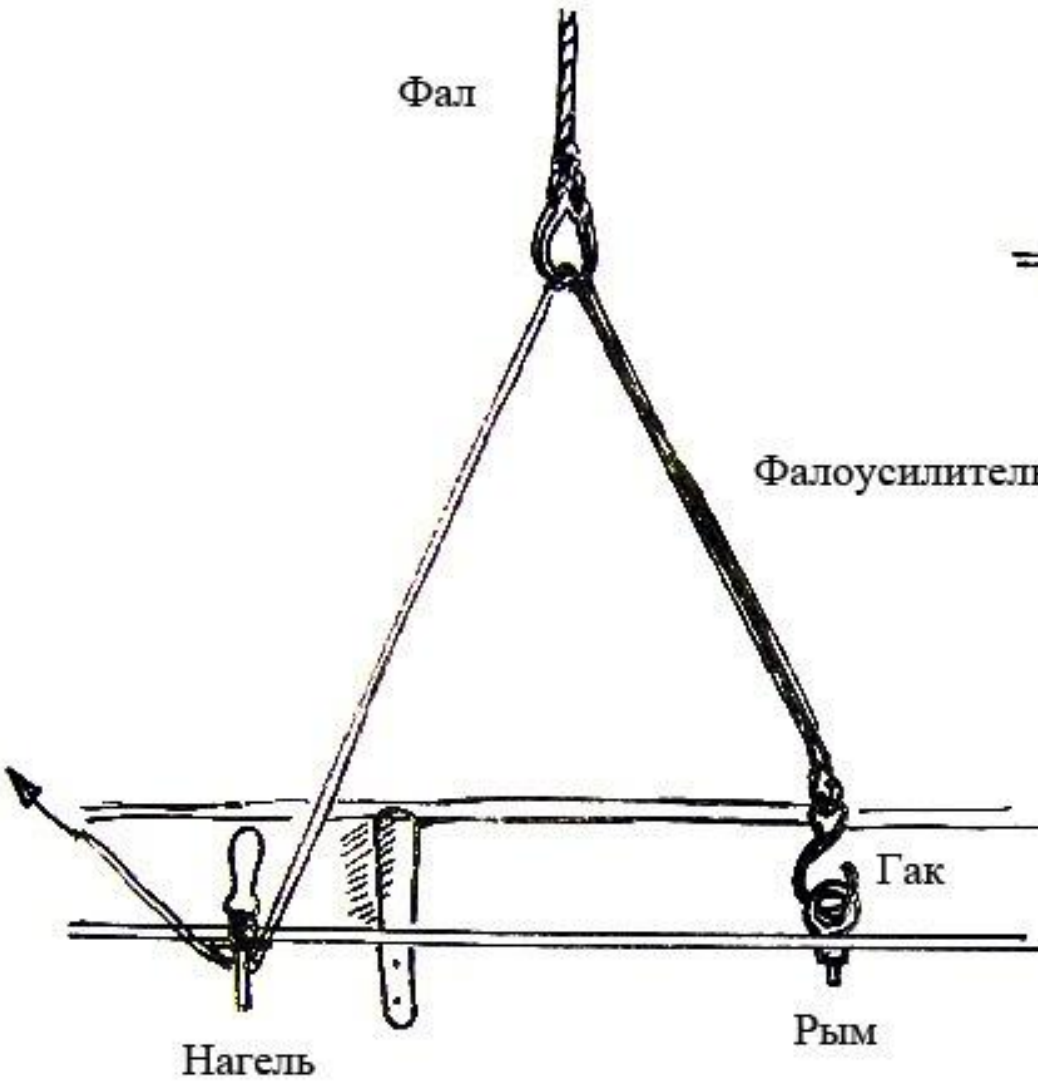

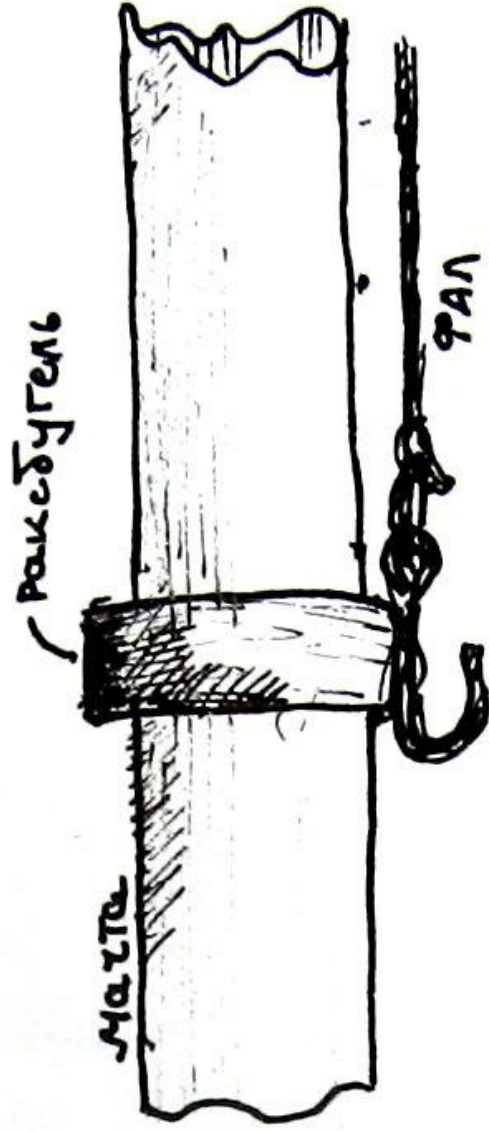
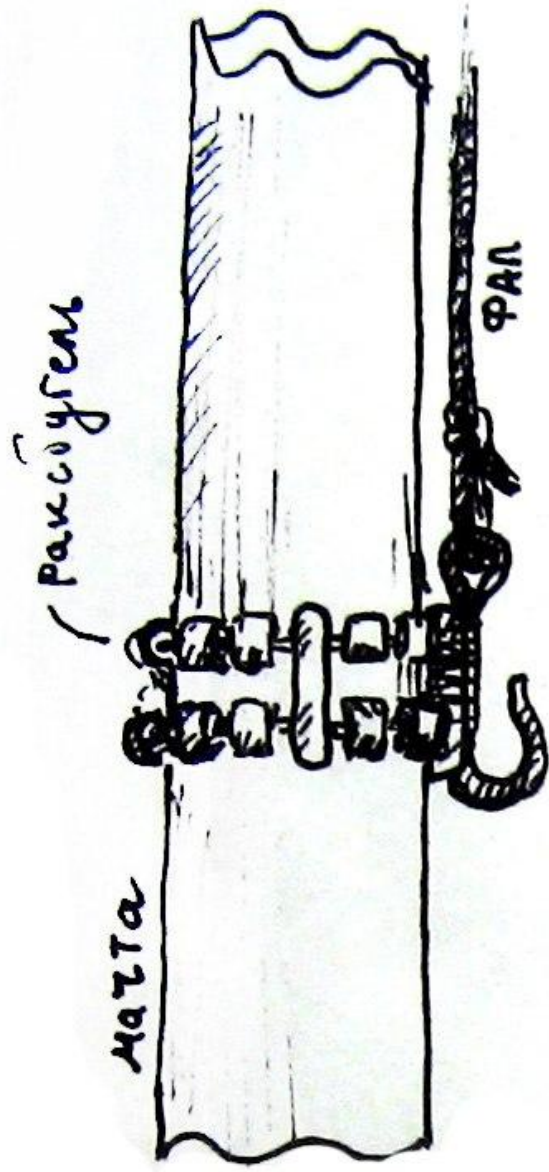

Раксугель











