

ОБВОДКА ПО КОНТУРНЫМ ОРИЕНТИРАМ

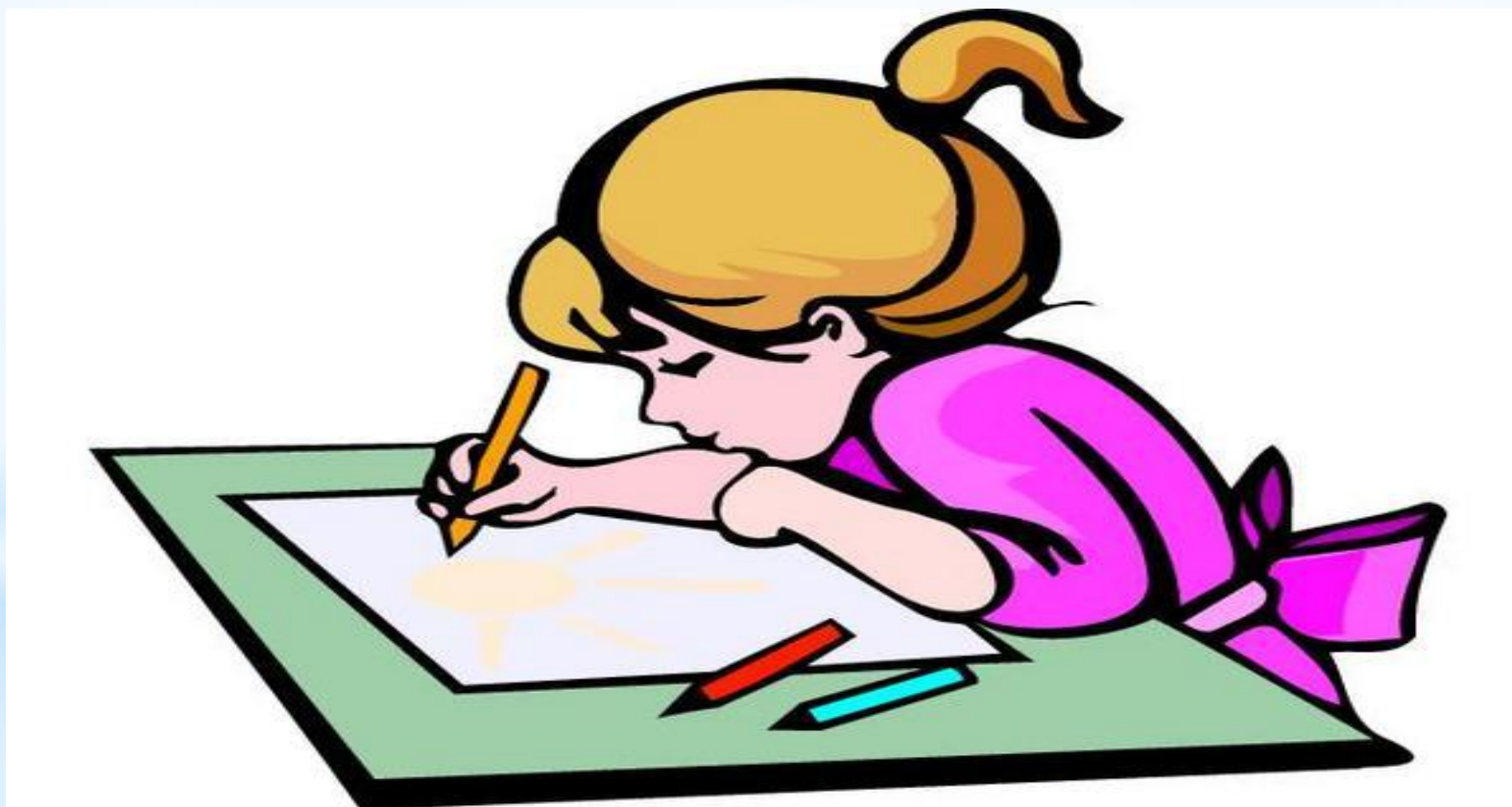

**Мы пришли сюда учиться.
Не лениться, а трудиться.
Слушаем внимательно,
Работаем старательно.**

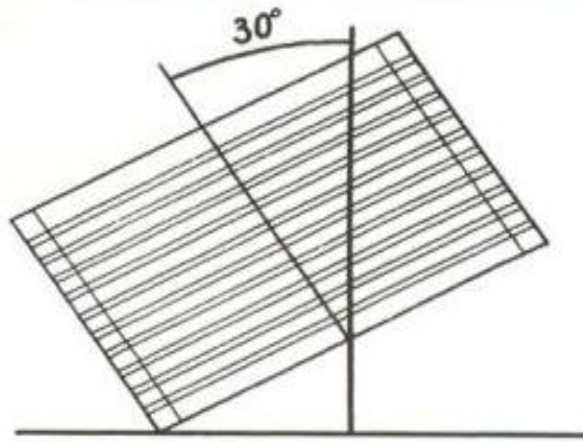

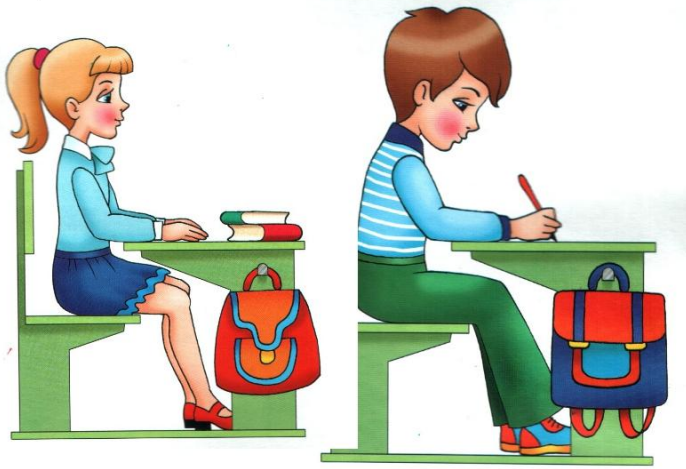

**Я тетрадь свою открою
И наклонно положу.
Я от вас, друзья, не скрою
Ручку я вот так держу.
Сяду прямо, не согнусь,
За работу я возьмусь.**



Левая рука

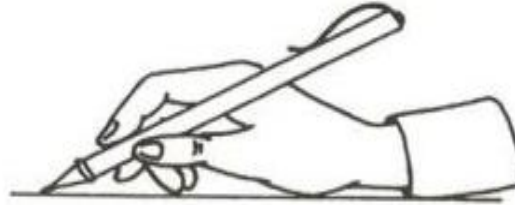

Правая рука

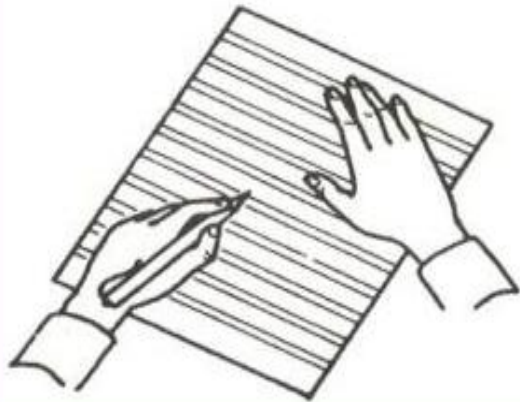

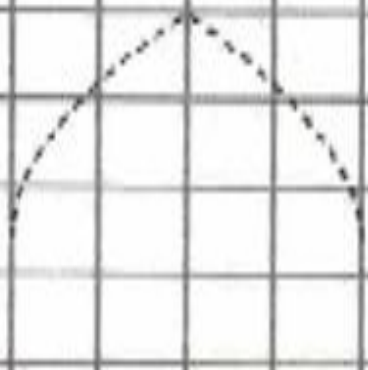
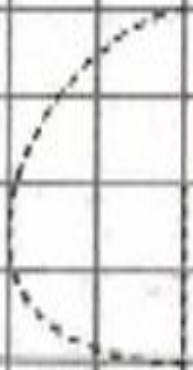
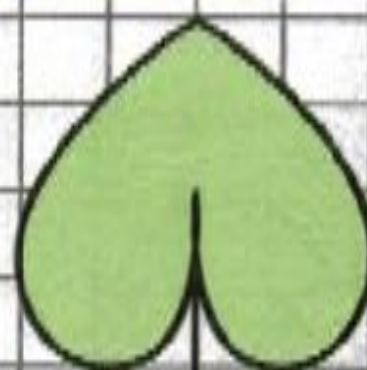
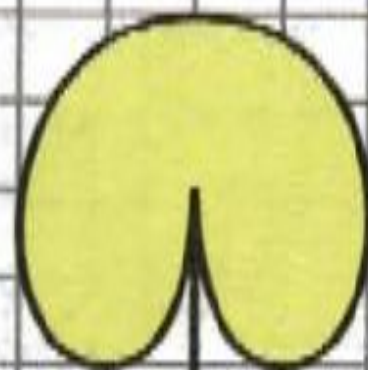
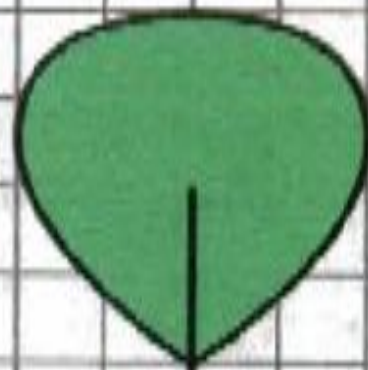
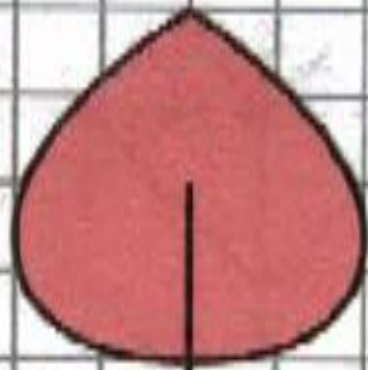
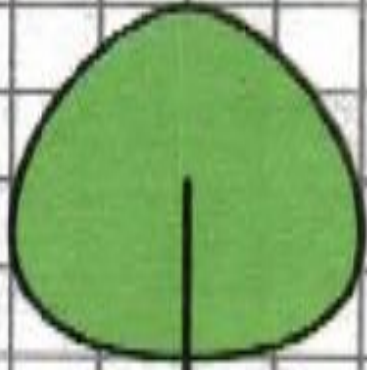

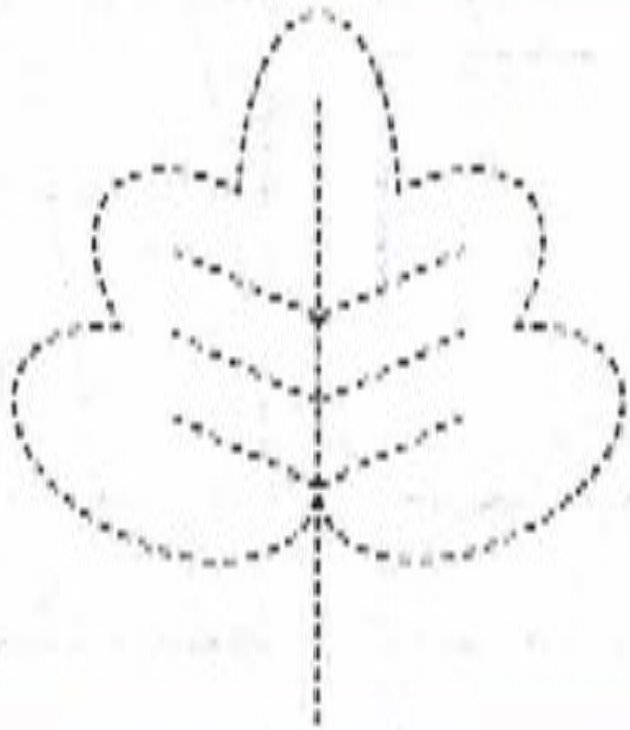
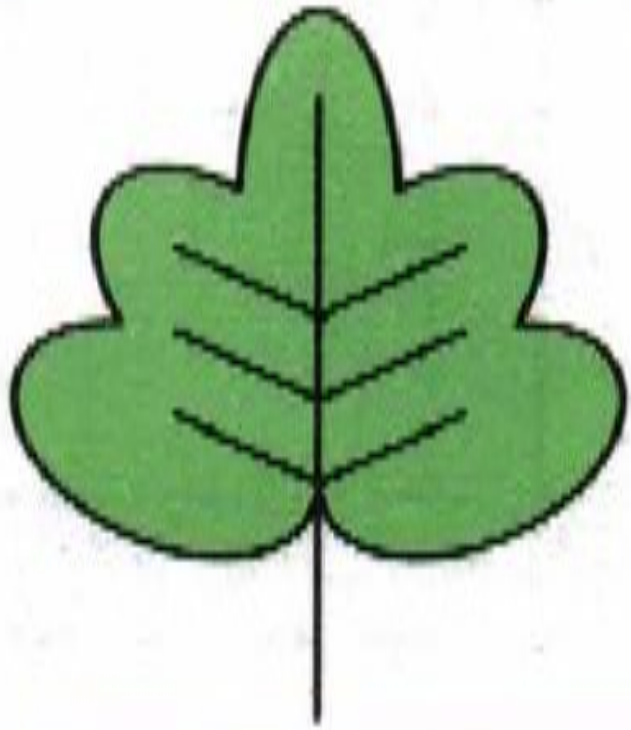

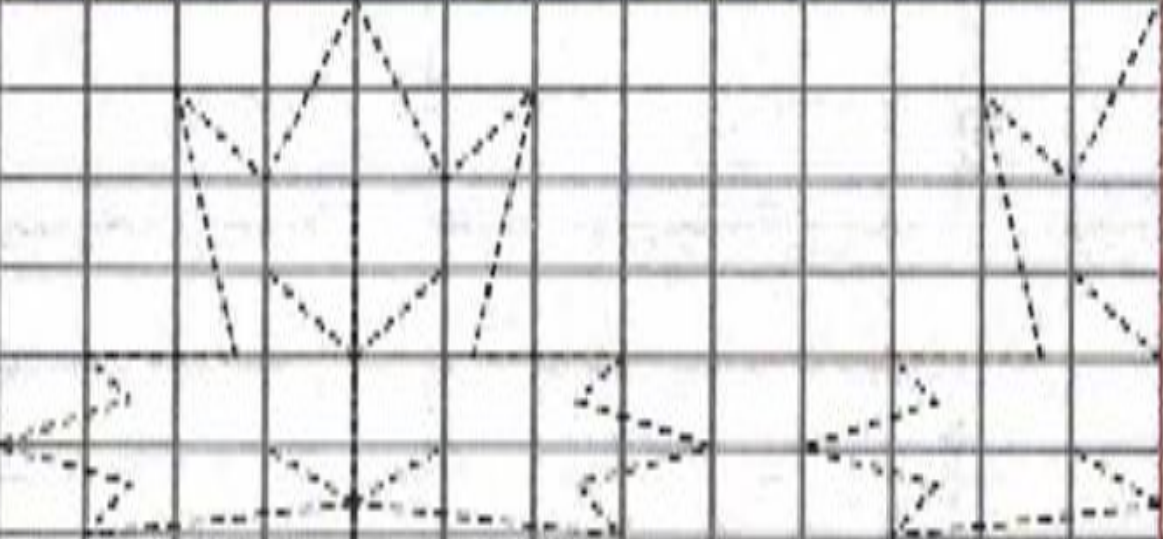
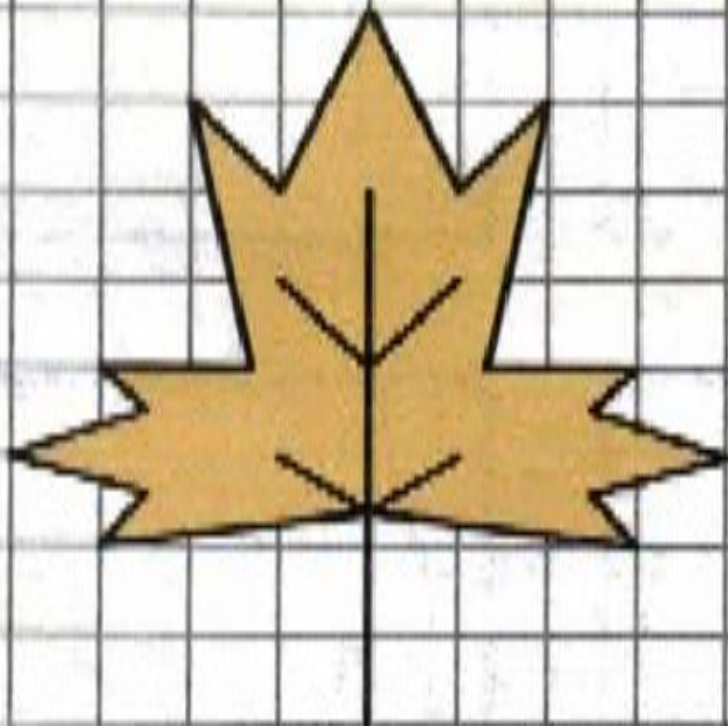

Ц В Е Т О К



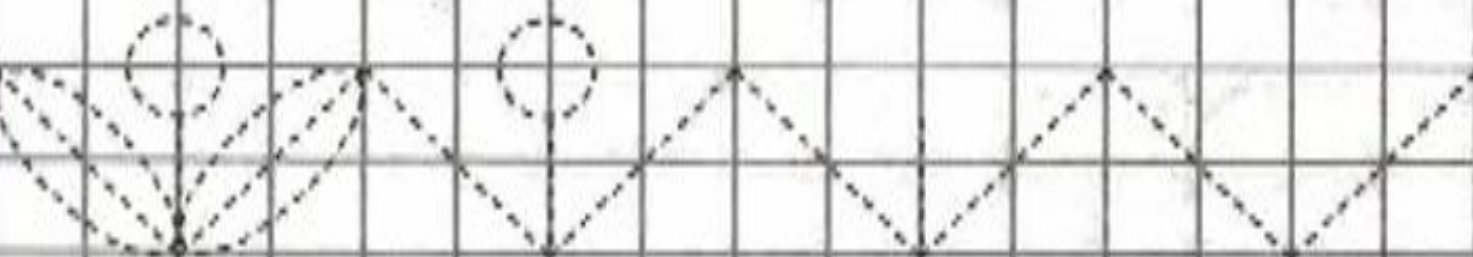
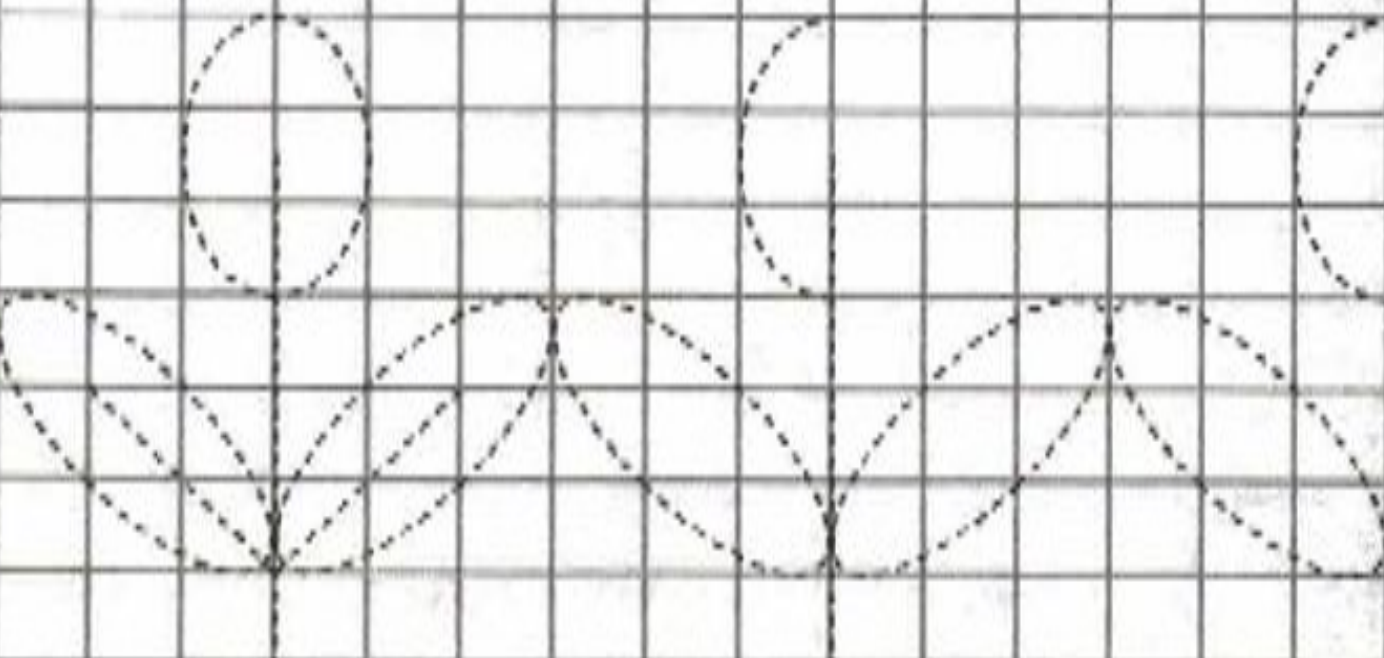
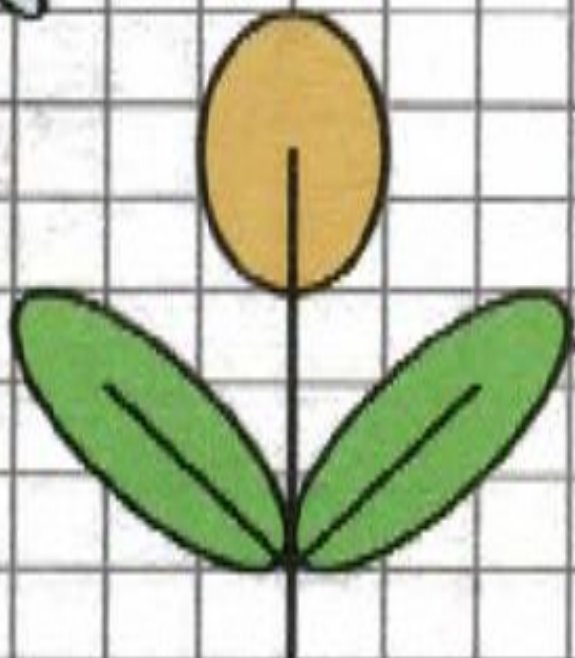
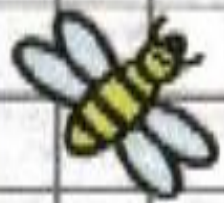



Handwriting practice sheet with three rows of lines. Each row consists of a top dashed line, a middle solid line, and a bottom solid line.

- Row 1:** A continuous zigzag pattern. The first two peaks are solid black lines with a black dot at their apex. The remaining peaks are dashed lines. The pattern starts at a red dot on the bottom line and ends at a red dot on the top line.
- Row 2:** A continuous zigzag pattern. The first two valleys are solid black lines with a black dot at their trough. The remaining valleys are dashed lines. The pattern starts at a red dot on the top line and ends at a red dot on the bottom line.
- Row 3:** A series of six 'W' shapes. The first two are solid black lines with a red dot at their starting point on the bottom line. The remaining four are dashed lines.

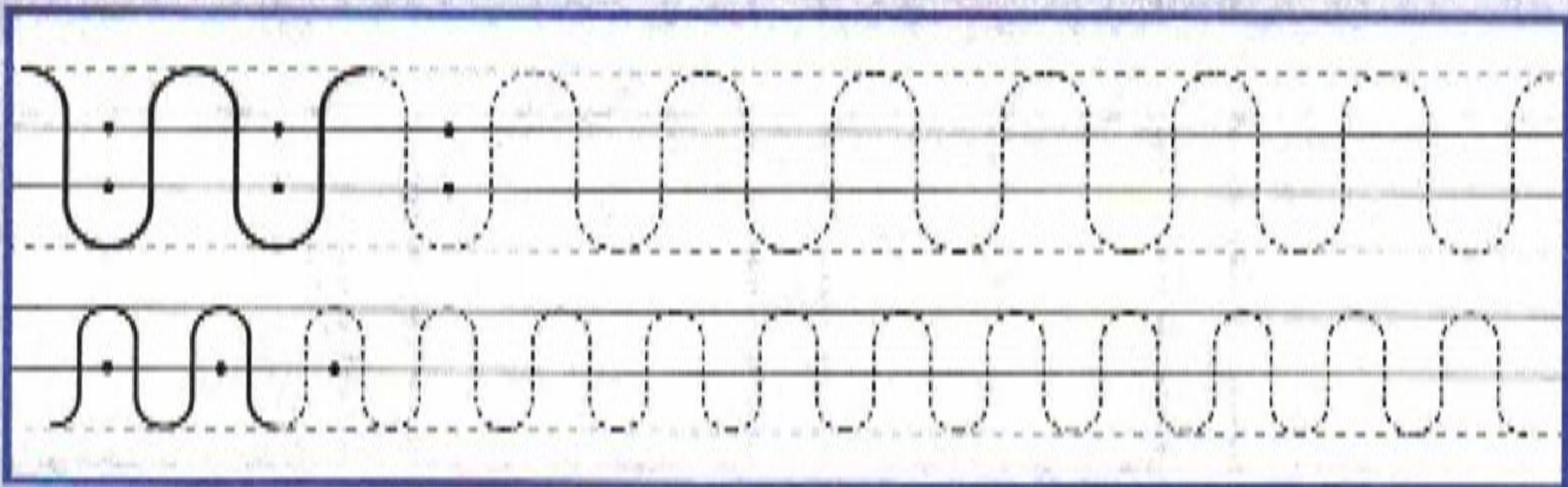

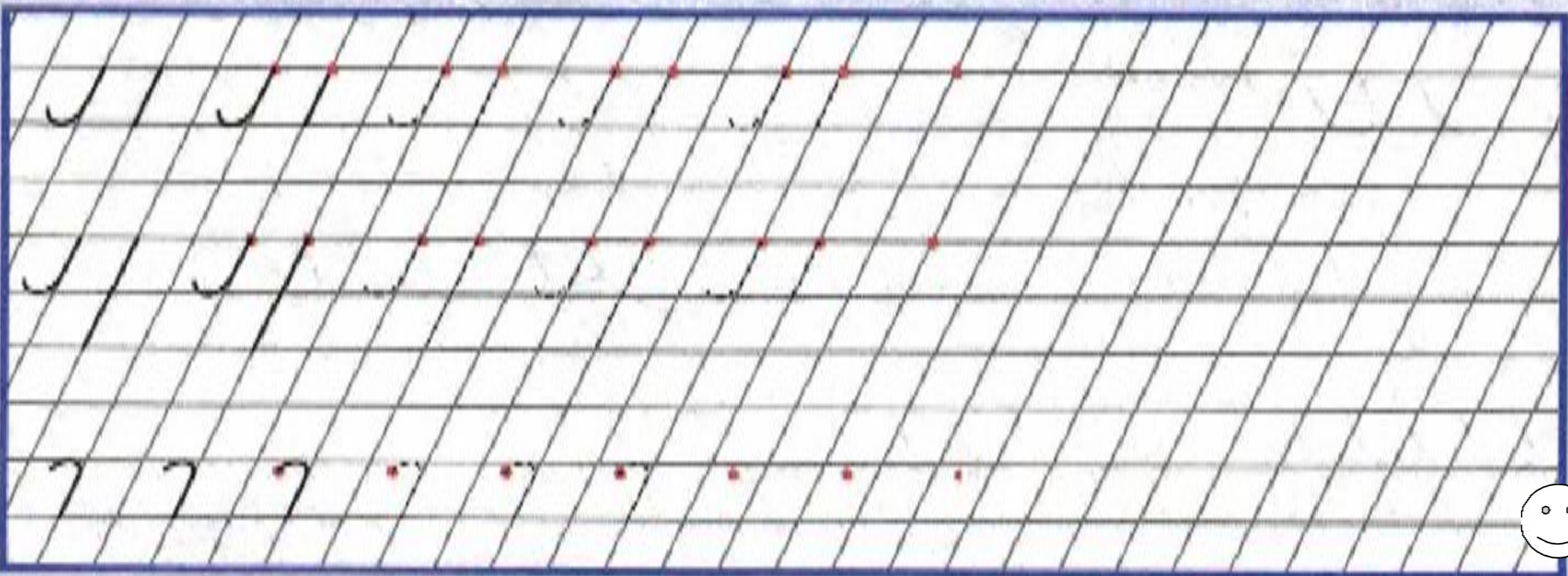

СЛАДКО!!!

Тема: Обводка по контуру. Подготовка к письму букв.

Цель: Знакомить учащихся с разлиновкой тетради, учить находить рабочую строку.

Задачи: Развивать у детей мелкую моторику руки, координацию движений, глазомер; формировать умение обводить рисунки и элементы по контуру; развивать восприятие, внимание, мышление, речь, воображение.