

Бюджетное профессиональное учреждение
Орловской области
«Орловский техникум агробизнеса и сервиса»

Проект по теме:

Особенности конструкций V-образных
двигателей.

Выполнил:
Пшеничников Артём

Мценск, 2021 г.

ИСТОРИЯ СОЗДАНИЯ

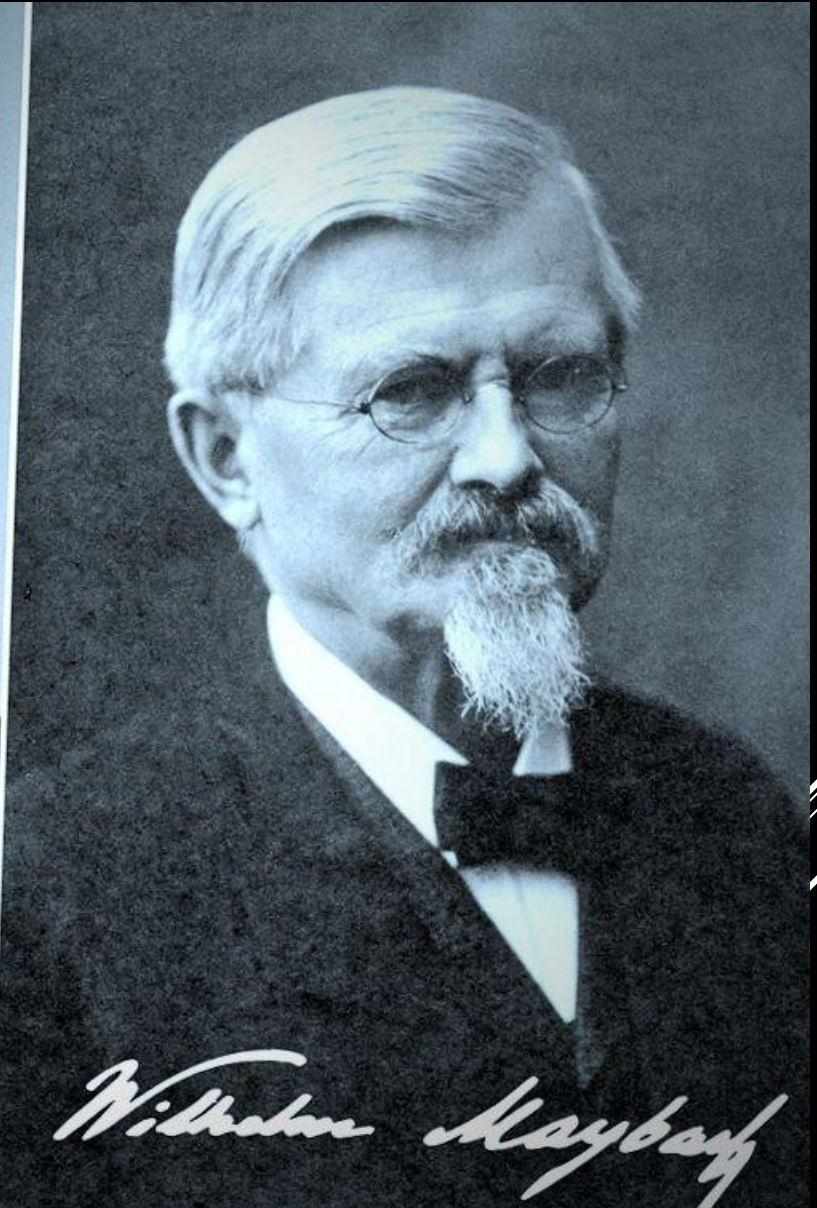

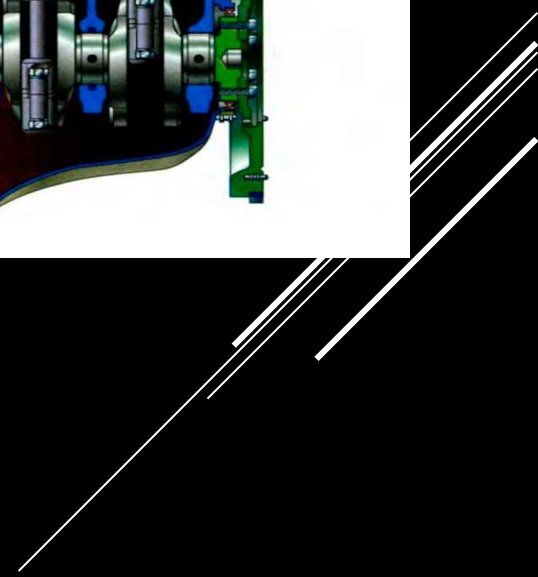
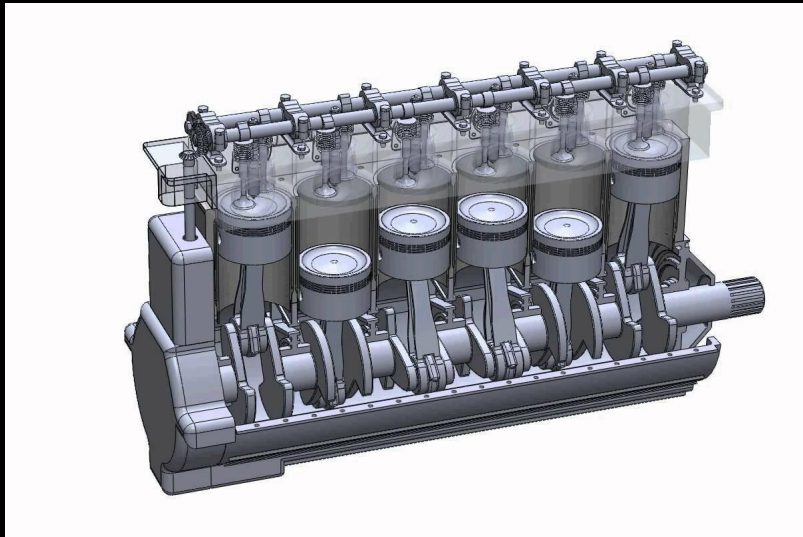
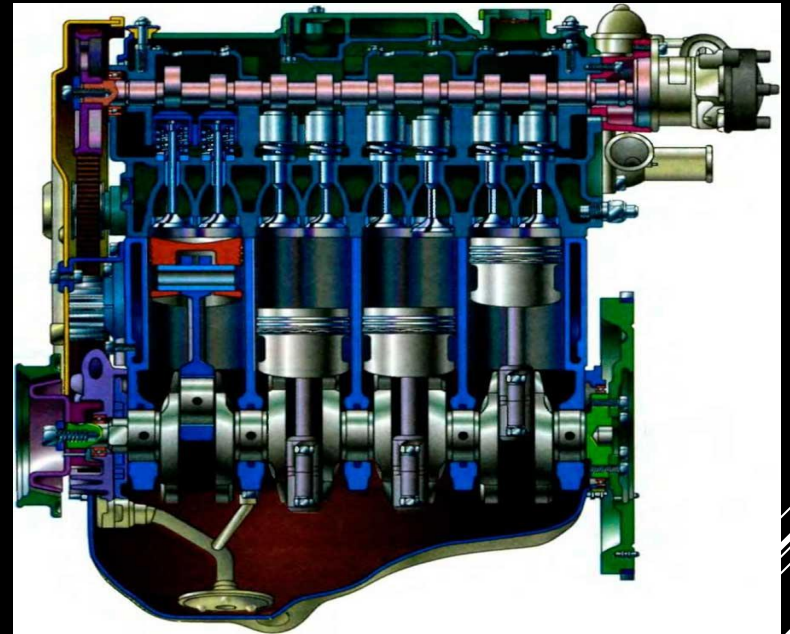
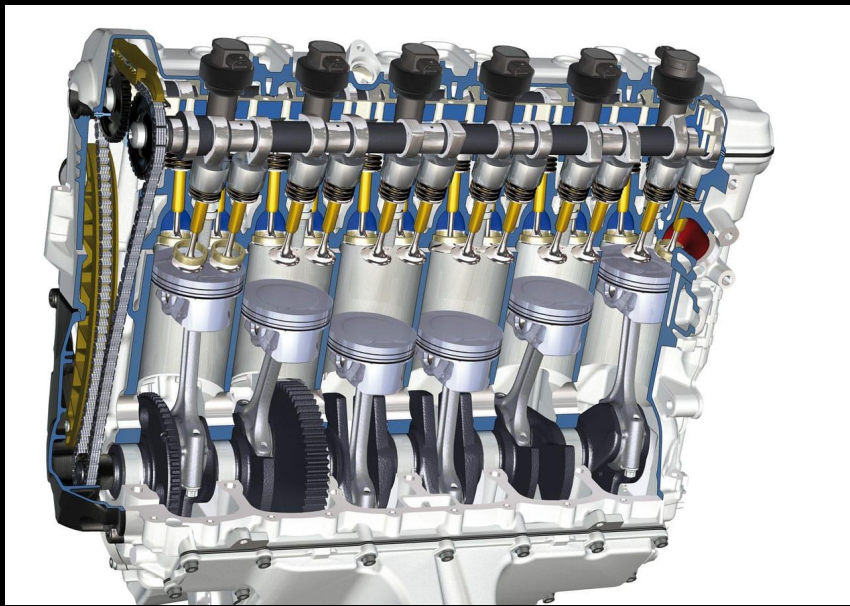

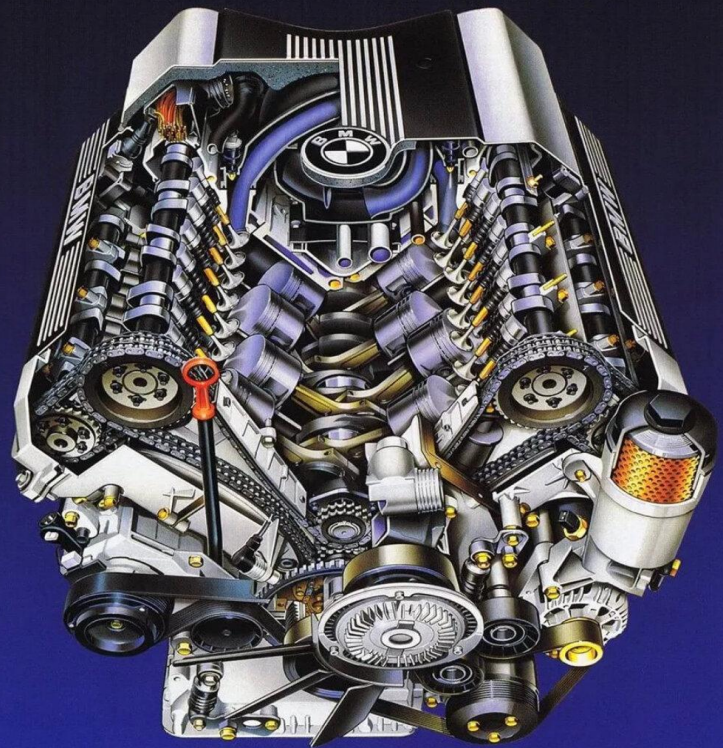
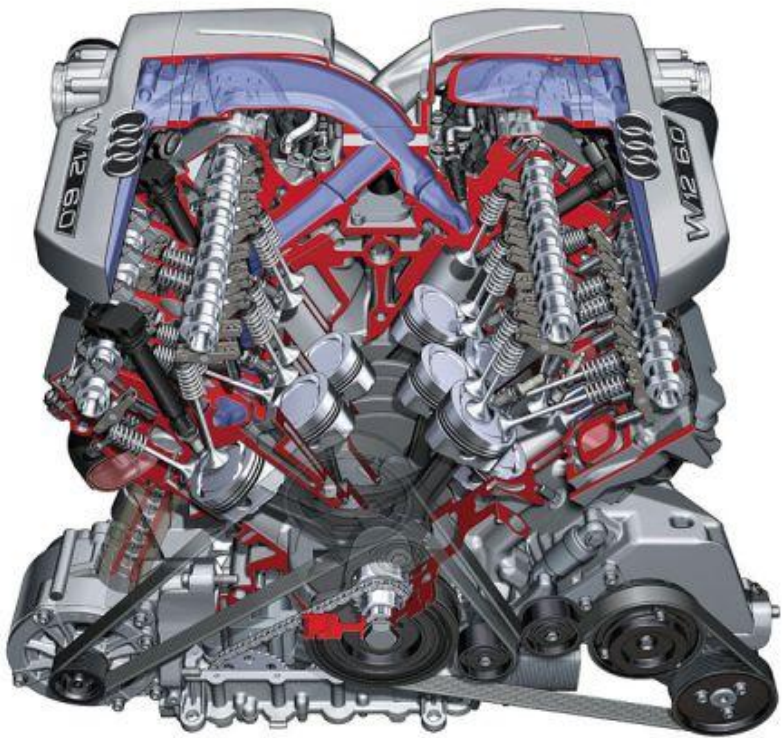

TD6

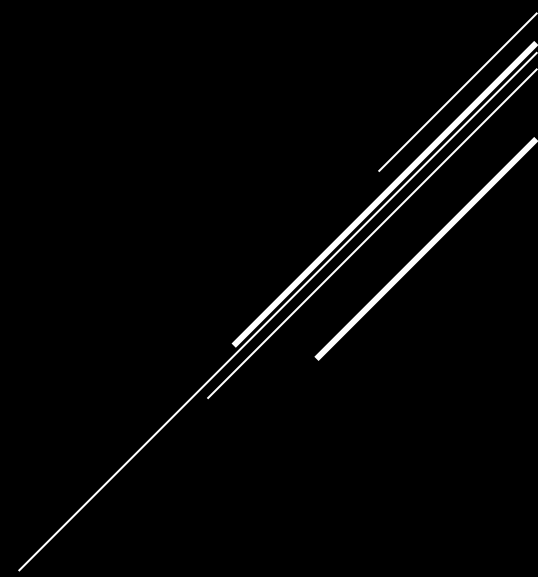
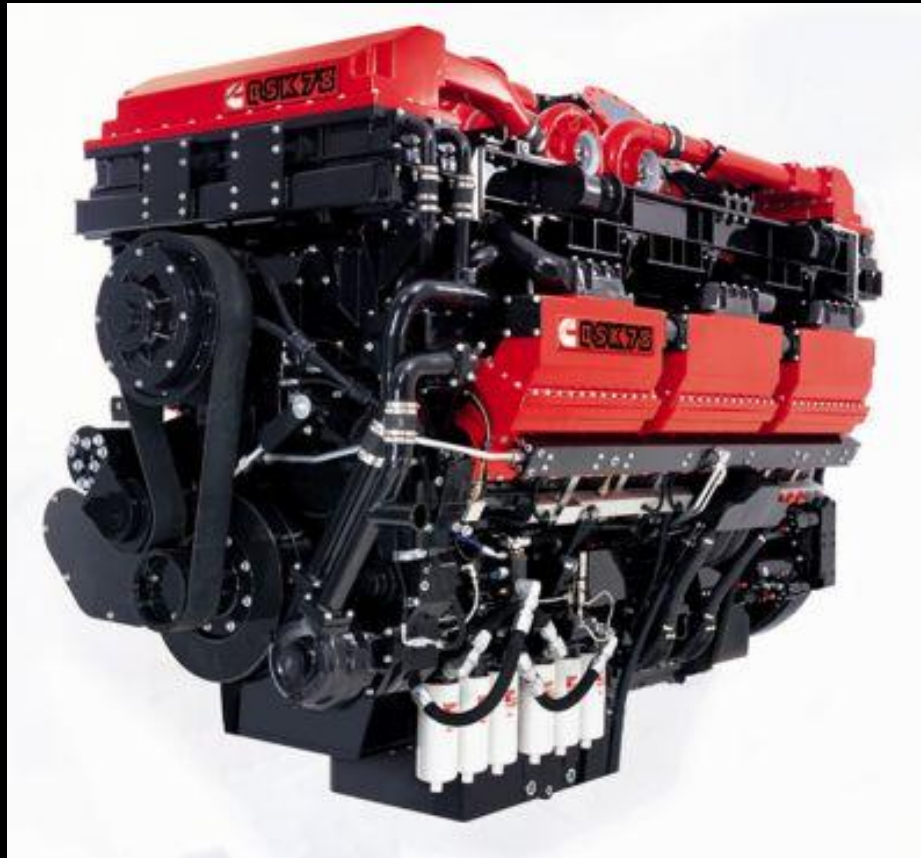

ОСОБЕННОСТИ КОНСТРУКЦИИ

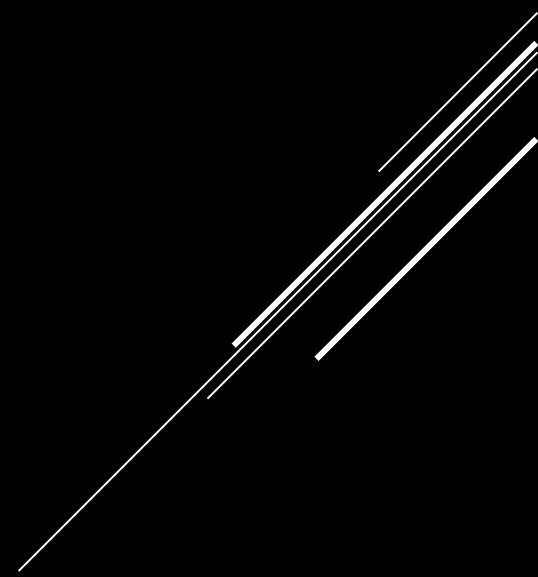
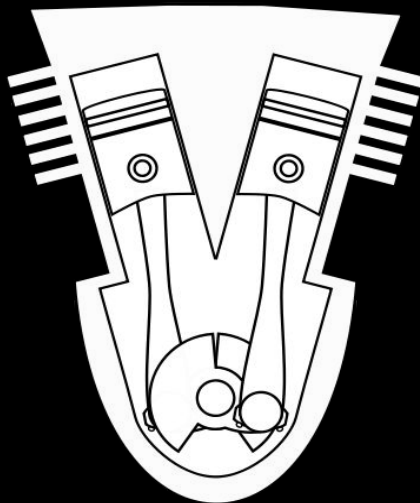
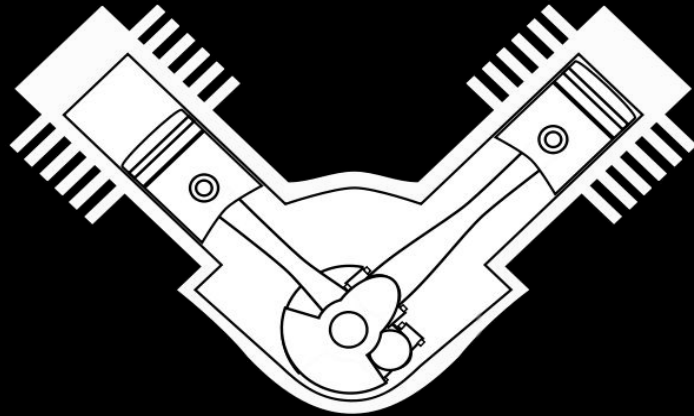
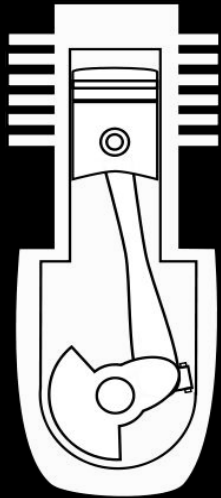

V16



V12

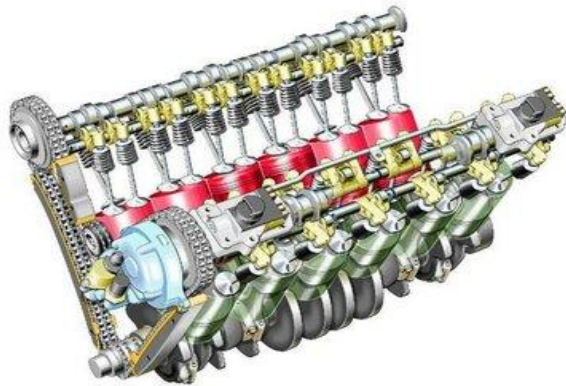

V10

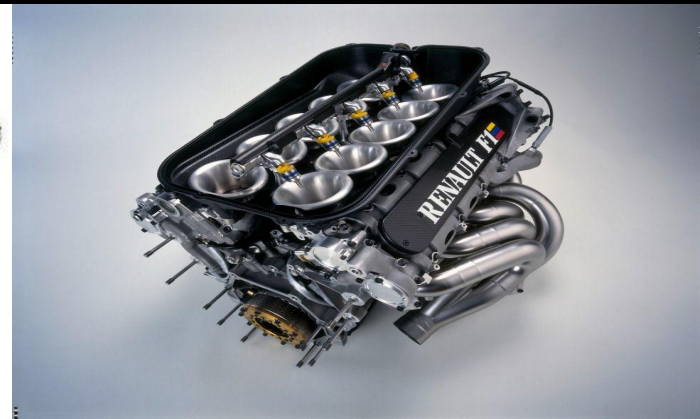

V4

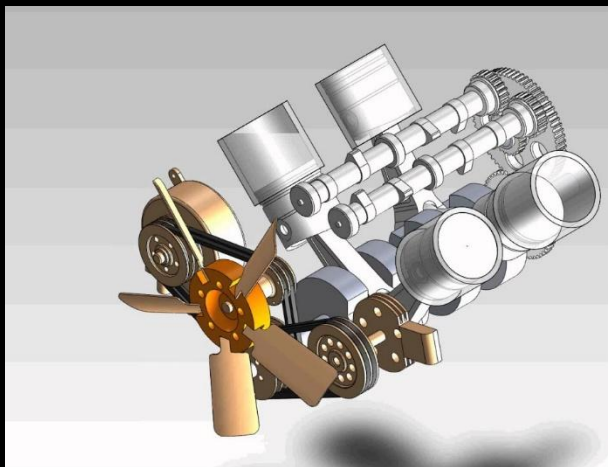

V6

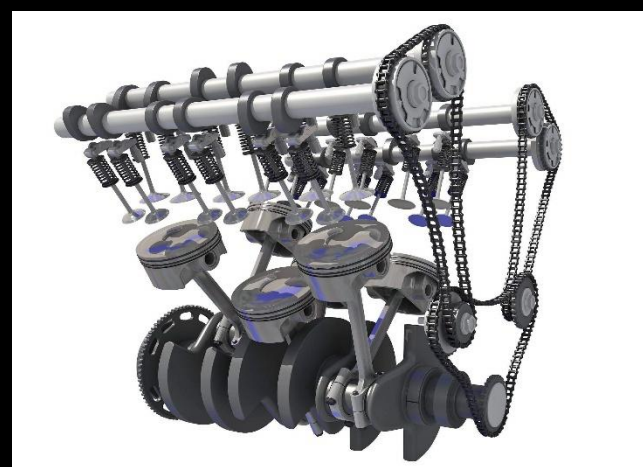

ДОСТОИНСТВА И НЕДОСТАТКИ

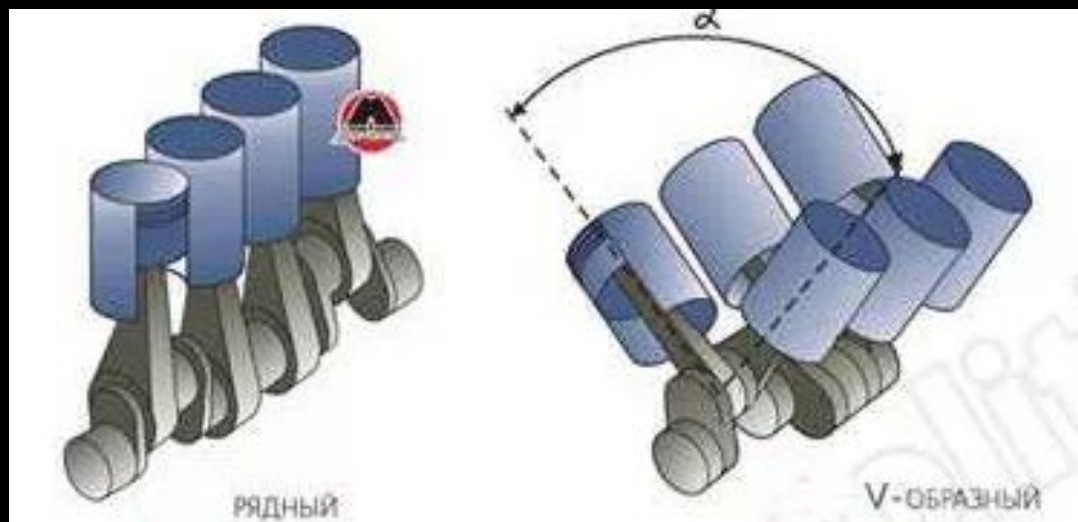
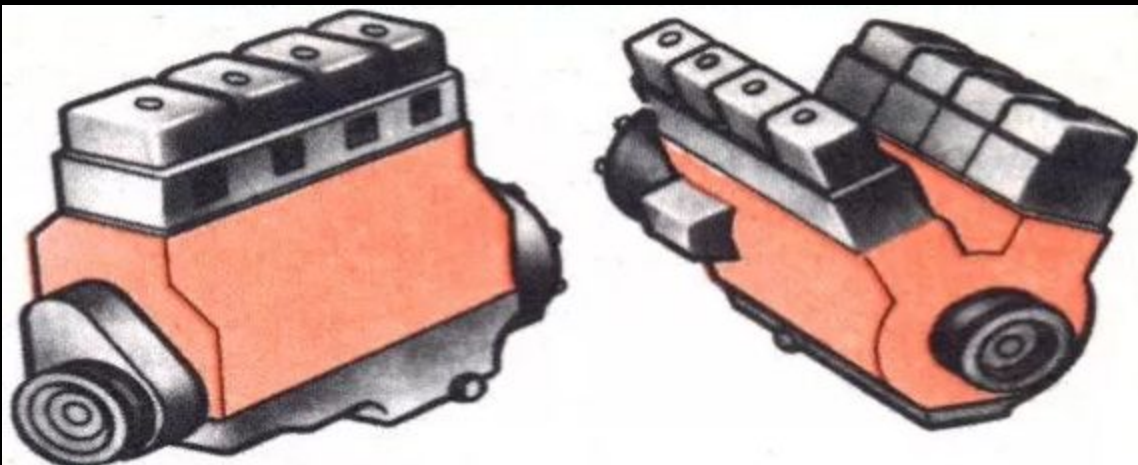

ЗАКЛЮЧЕНИЕ

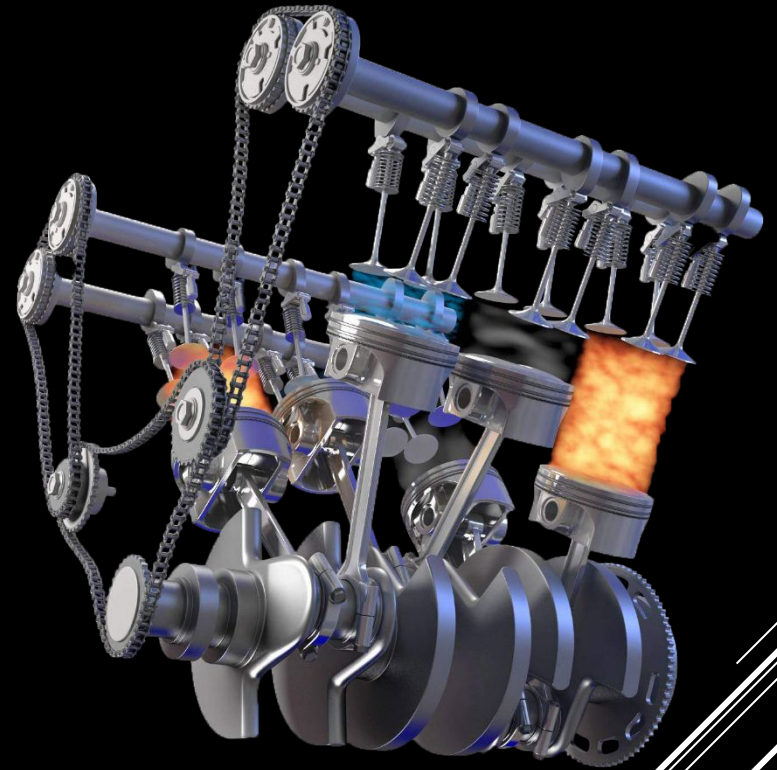

СПАСИБО

ЗА ВНИМАНИЕ

