



# 彩熠新产品介绍

主讲：

# TEKMAND D控制台介绍



# 控制台系列产品



New

TEKMAND D



New

TEKMAND COMMAND WING



New

TEKMAND DADER WING



TEKMAND V



TEKMAND IV



TEKMAND III



TEKMAND MINI

## TEKMAND D

●控制参数:4096, 可扩展至65536

●1个调光轮, 4个编码器

●内置3个10.1寸多点电容触摸屏

●18个执行推杆, 18个执行按键, 2个A/B推杆

●3个USB接口, 1个工作灯接



●按键背光独立可调

●5个DMX输入/输出



●MIDI 输入/输出

●LTC/SMPTE输



●音频输入/输出

●1个千兆网口

●净重: 9.3KG

●尺寸: 773 X 456 X 218MM

TEKMAND D型控制台主要是以稳定为前提, 并具有轻, 薄, 小, 携带方便, 功能强大, 使用简单等特点来设计的; 硬件配置的高度集成化设计、配合软件和网络等多种先进的技术, 以及多点电容触摸屏与按键功能双向结合的控制方式, 为演出提供了更强大的保障。



新品

适用于:

- 1.能满足各种中、小型演出活动;
- 2.可随身携带, 特别适合流动演出。



# 2017年美国LDI展会

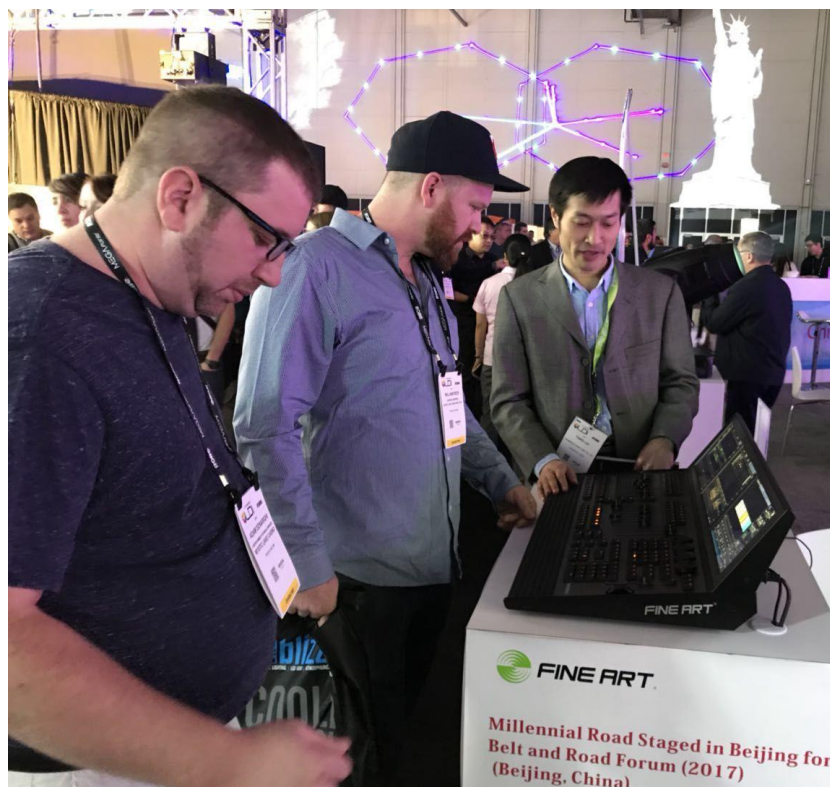

## TEKMAND D高度集成化硬件

**Tekmand D高度集成化硬件的设计，具有超高的稳定性，抗震，耐运输等特点。**



# 操作方便、功能强大

控制方式多样化





# Tekmand 灯光控制系统的主要特性

## 多语言操作系统

TEKMAND D系统与TEKMAND其它系列控台的系统相同，可互相联机备份。  
Tekmand系统支持多种操作语言、可自由更改，即时生效，无需重启。

各种语言版本的Show通用。



## Tekmand 灯光控制系统的主要特性

### 多种输入法支持

Tekmand系统支持多种输入法，如：中（拼音，五笔），英，韩，涂鸦等。

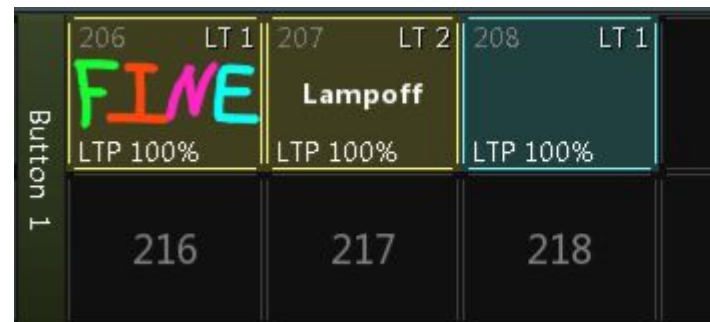

## 媒体播放器

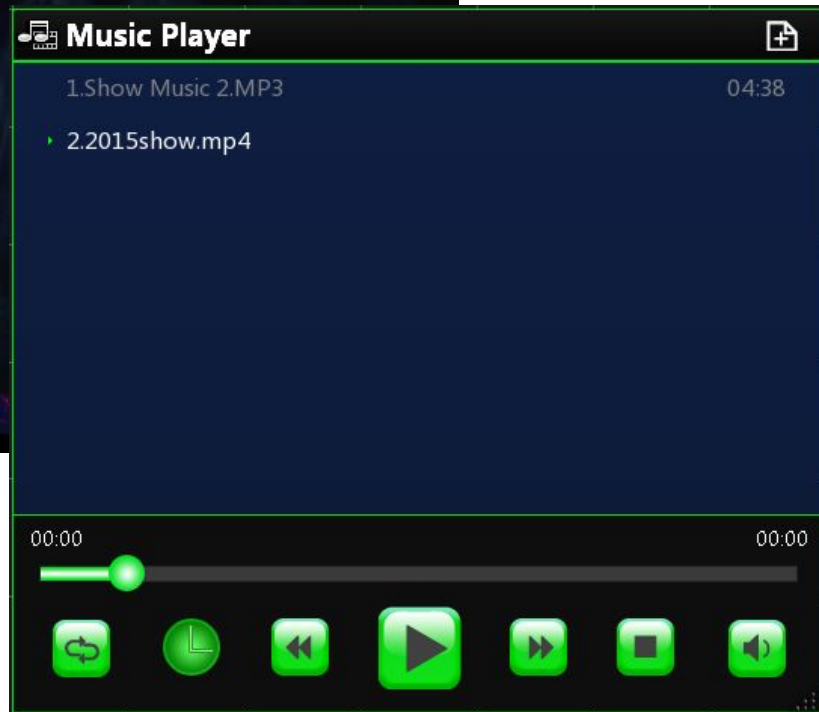
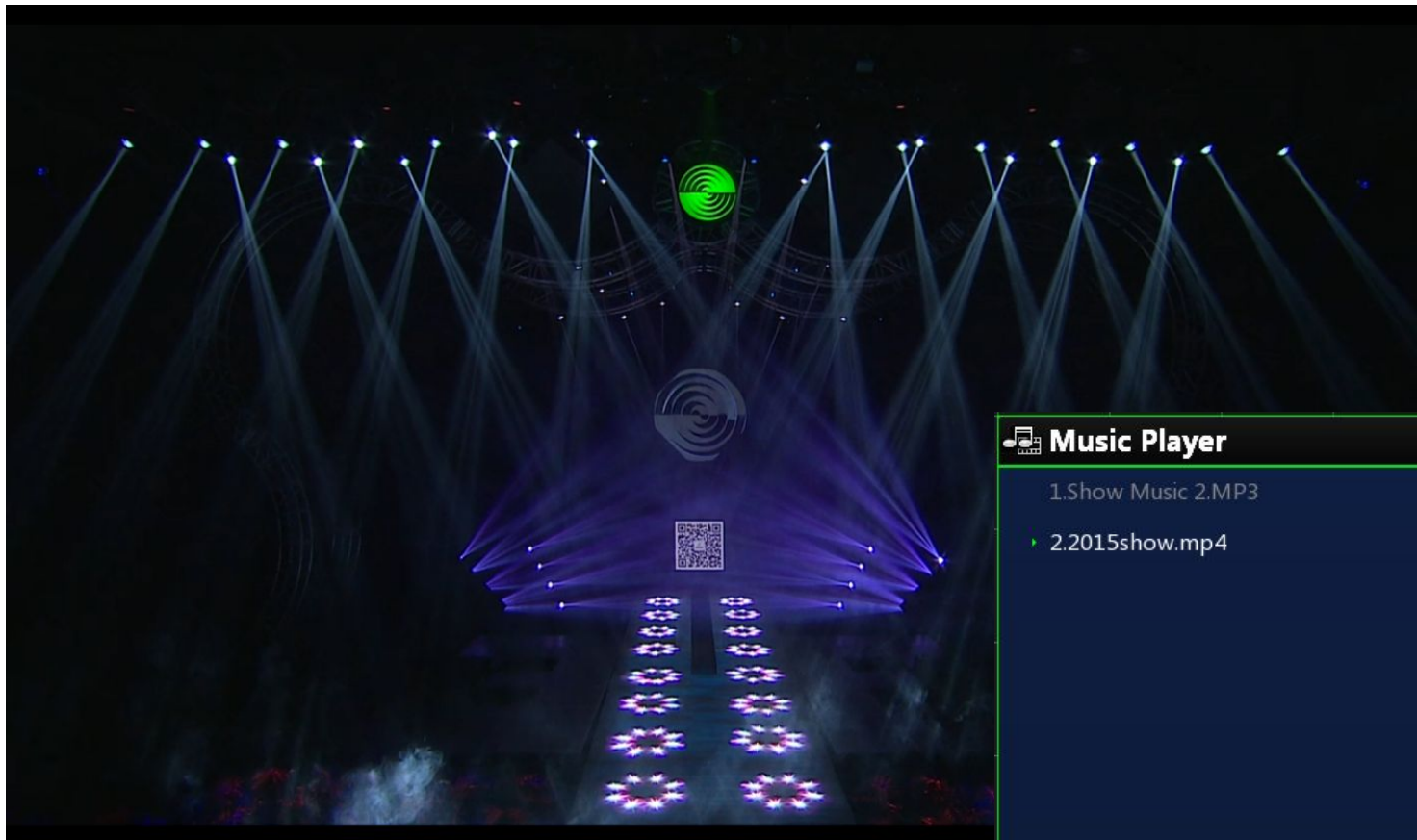

支持多种文件格式，如：mp3, wmv, mp4, avi, mpg  
等。Tekmand控制台自带音频输出口，可直接输出到调音台。  
Tekmand还内置有喇叭、耳机口，在编程的同时也可欣赏音乐。



## 时间码 & 媒体播放器

- 内置的播放器和时间码可以同步（需设置），更加方便时间码的录制和触发播放。

The screenshot displays a software interface for timecode and media playback. The main window shows a timeline with a current timecode of 0:02:23.10. The timeline is divided into tracks, including MIDI tracks (e.g., '76 'Ssharp pan'', '77 'Sled'', '78 'Sled'', '79 'LT led'', '80 'RT led'') and Master tracks. The tracks are organized into groups, with the '79 'LT led'' group highlighted in blue. The interface includes a 'Mouse Tools' section with buttons for 'Select Event', 'Move Event', 'Copy Event', 'Paste Event', 'Create Selection', 'Add Event', 'Delete Event', 'Manual Record', 'Add Here', and 'Delete Selected'. A 'Direct Tools' section contains 'Activate All Tracks', 'Sort Tracks', and 'Track To'. A 'Music Player' window is open, showing a list of files: '1.Show Music 2.MP3' (04:38) and '2.2015show.mp4'. The Music Player window has a progress bar and playback controls (play, stop, next, previous, volume).

## CITP(媒体服务器扩展)

- CITP是“控制器接口传输协议/媒体服务器扩展”的简称。Tekmand可以通过CITP协议预览/读取媒体服务器里的视频、图片，还可以实时监视媒体服务器当前正播放的视频。
- Tekmand通过CITP可以更有效地控制媒体服务器。



## RDM远程灯具管理

- RDM功能可以直接在控台上远程修改灯具DMX地址，水平 & 垂直反向等参数，无需人工到灯具面板上设置。



# Tekmand APP 远程控制

- IOS系统（如：Ipad, Iphone）和Android系统的设备都可以直接连接到Tekmand控制台进行远程控制。如：Tekmand控制台在演播室，操作员可以拿着个Ipad直接到舞台上进行对光等，Ipad也相当于一个无线控台。

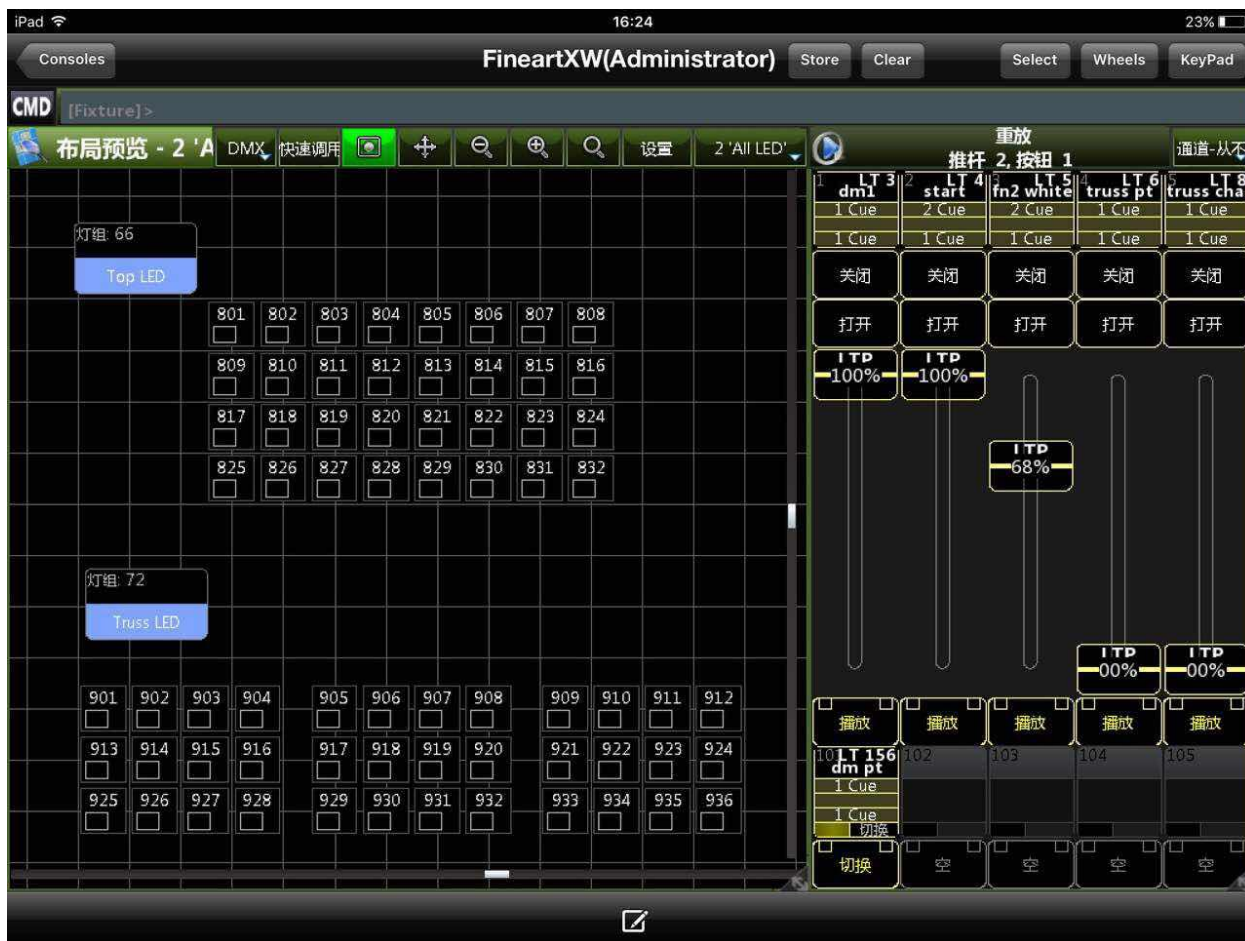



## 布局 -- 直观2D编程

灯具按舞台位置对应排列在布局里，将布局当作是舞台灯位的平面图，可更精准的找到灯具并控制。布局里具有快速排列工具，可将灯具以及其他对象快速排列成圆形，螺旋形，矩形或自定义形状。并有多种选择灯具的方式：框选，虚线，实线。选灯顺序规则有：单向（默认），回向和螺旋。

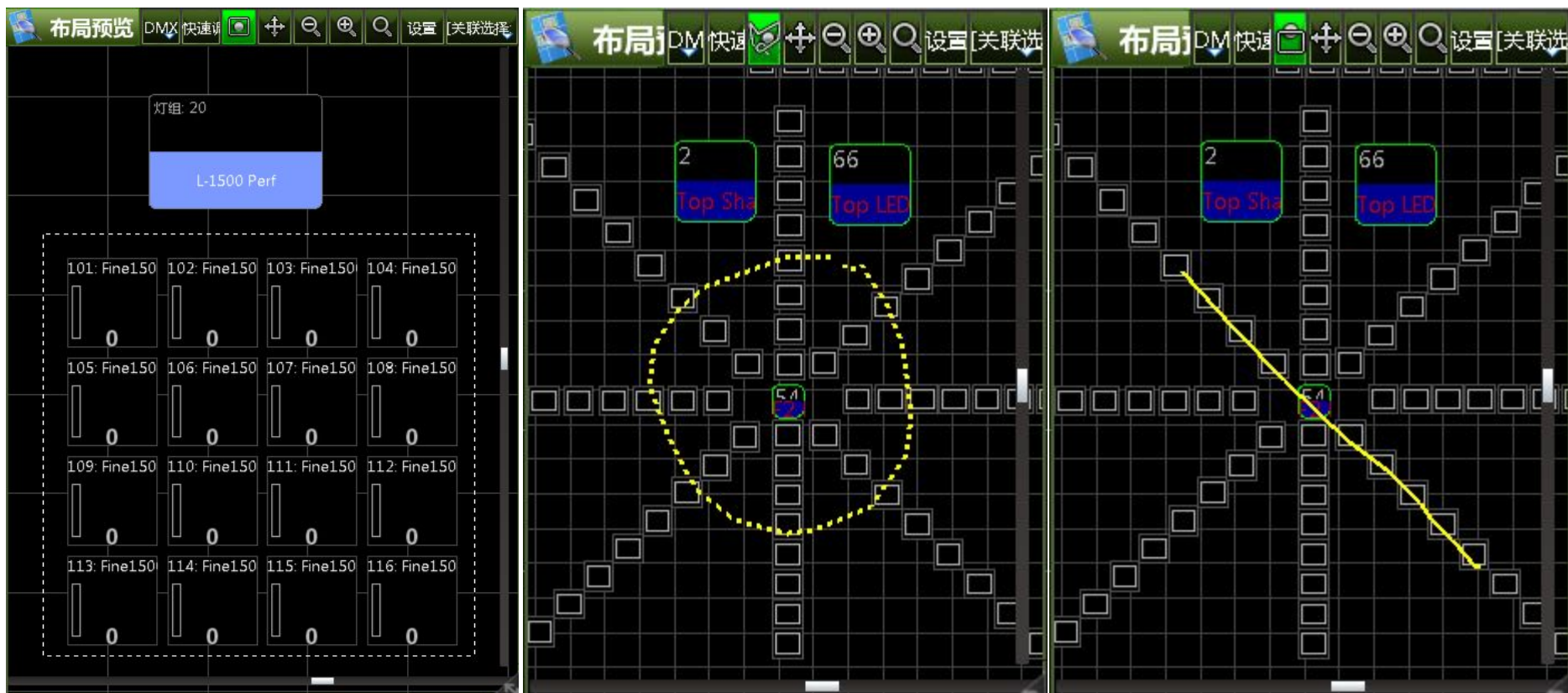

## 软件实时备份

- 实时备份功能可以保证控台的Show永远不会丢数据。用户可以找回或还原到任何一个时间点做的Show, Cue或效果等等。有了这个功能, 再也不必担心会丢失数据, 或找回被误删除的Show了。





## 文件查看器

Tekmand自带的文件查看器，目前可以查看文本文档，各种格式的图片（.bmp, jpg, png...）。



## 硬件检测

- Tekmand控制台自带有硬件检测功能，可以第一时间知道各部件的工作状况。

硬件检测锁定，按任意键退出。



## 3D模拟舞台



- Tekmand的舞台窗口，可以模拟现场舞台。
- 3D舞台窗口具有灯具跟随功能，选择灯具后，可以直接定位到舞台的各个角落，编程时更方便地快速定位灯具，无需逐个调整。

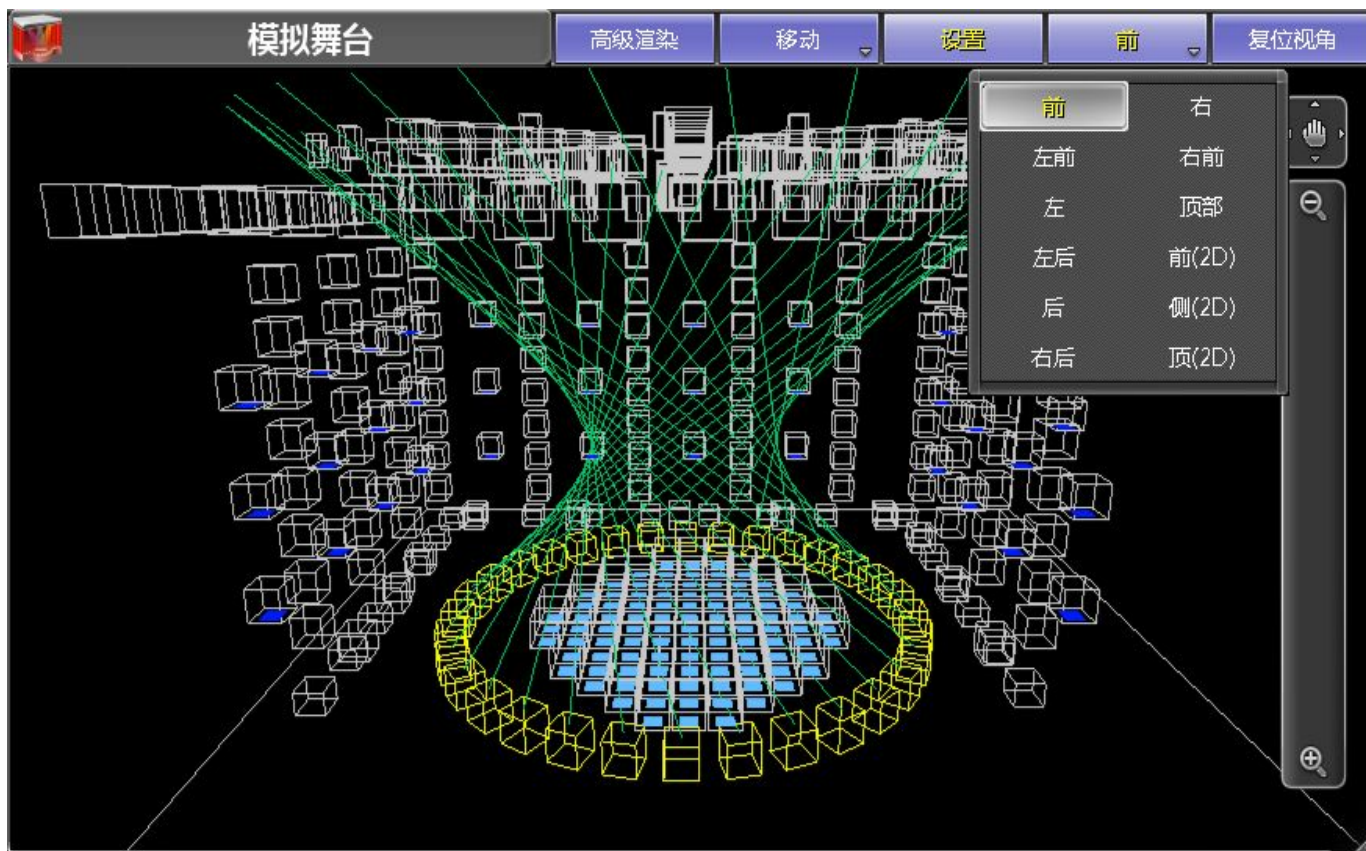



# 离线编程: Tekmand D与Visual 3D离线软件连接

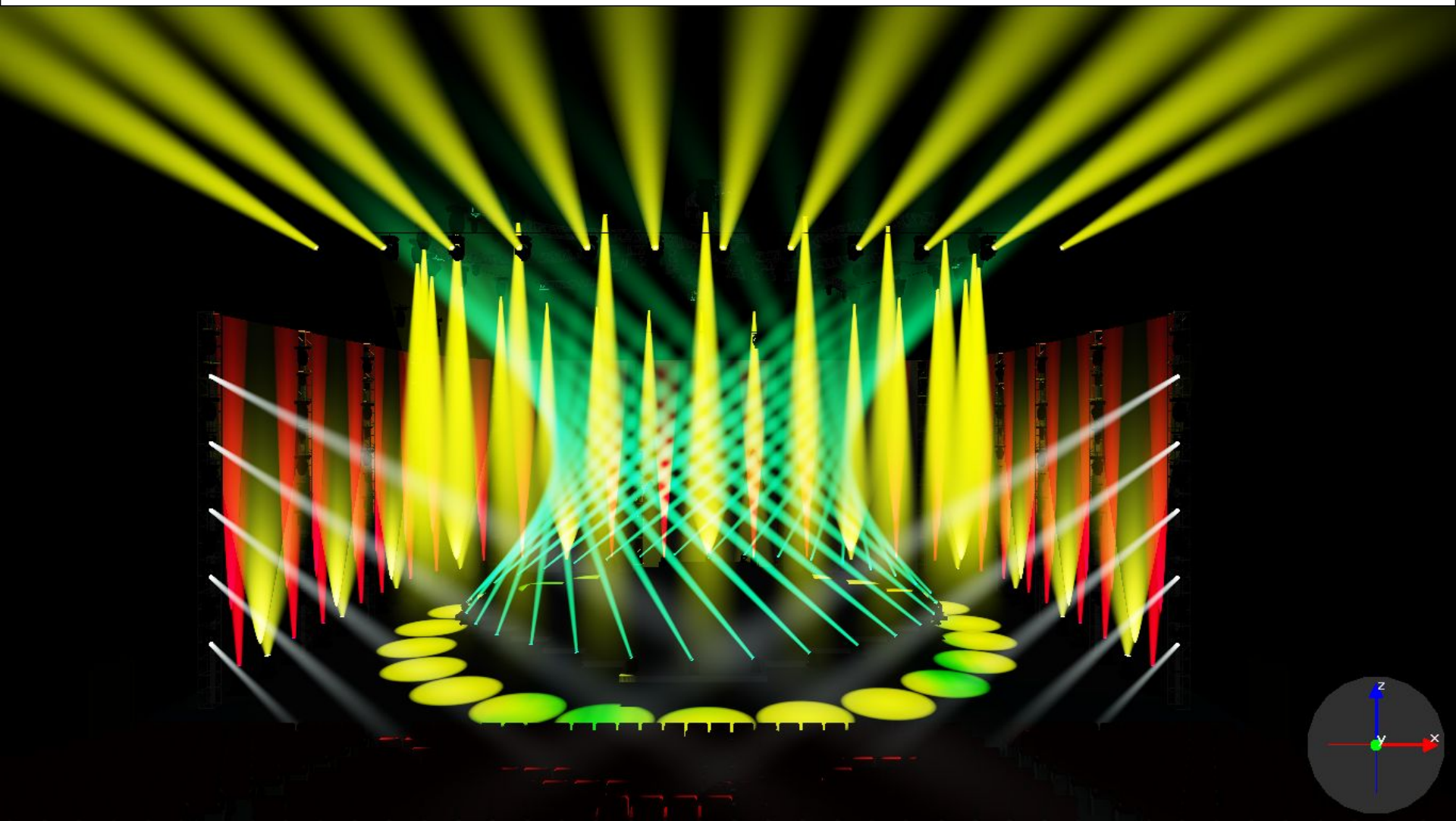

## Tekmand D 与 Dot2详细参数对比

型号/参数	Tekmand D	Dot2
操作系统	Tekmand可视化操作系统	Dot2
高清多点电容触摸屏	3	无
屏幕尺寸	10.1	7
Dmx输出口	5	4
推杆数量	18+3	14
系统语言	中, 英, 日, 韩, 法	英
输入法	中, 英, 韩, 涂鸦	英
媒体播放器	有	无
RDM	有	无
远程App	有	无
实时备份	有	无
硬件检测	有	无
内置多功能2D布局与3D模拟舞台	有	无
重量	9.3KG	9.1KG

# 电脑灯具介绍

**FINE 1400ZL系列**

**FINE 1400JD系列**

**FINE 1400CF系列**

**FINE 470 BSW/BEAM**





# 彩熠之星 (租赁版)



- ◆ FINE 1400ZL SPOT
- ◆ FINE 1400ZL PERF
- ◆ FINE 1400ZL WASH
- ◆ FINE 1400ZL WASH-PERF



# 彩熠之星系列产品

一款小体积, 紧凑型、高光效灯具, 使用OSRAM 1400W高显指灯泡。



相比于市面上1500W电脑灯：

1. 更高光通量输出；
2. 光斑更均匀，照度均匀度 $>80\%$ ；
3. 更高显色指数， $Ra>95$



# 产品特点

光源: Mini型1400W快装高显指光源

## OSRAM Lot-it! 1400/PS Brilliant

光源参数表	
光源型号	OSRAM Lot-it! 1400/PS Brilliant
功率	1400W
光通量	120000lm
光效	85 lm/W
色温	6000K
显指	max95
平均寿命	750h



# 产品特点

彩熠之星系列

## 1. 高光效：主副反光碗设计，光效利用率提高10%

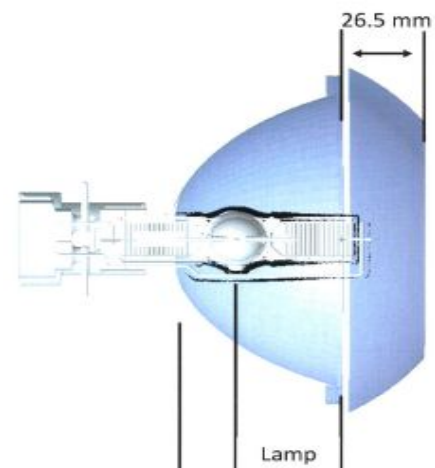
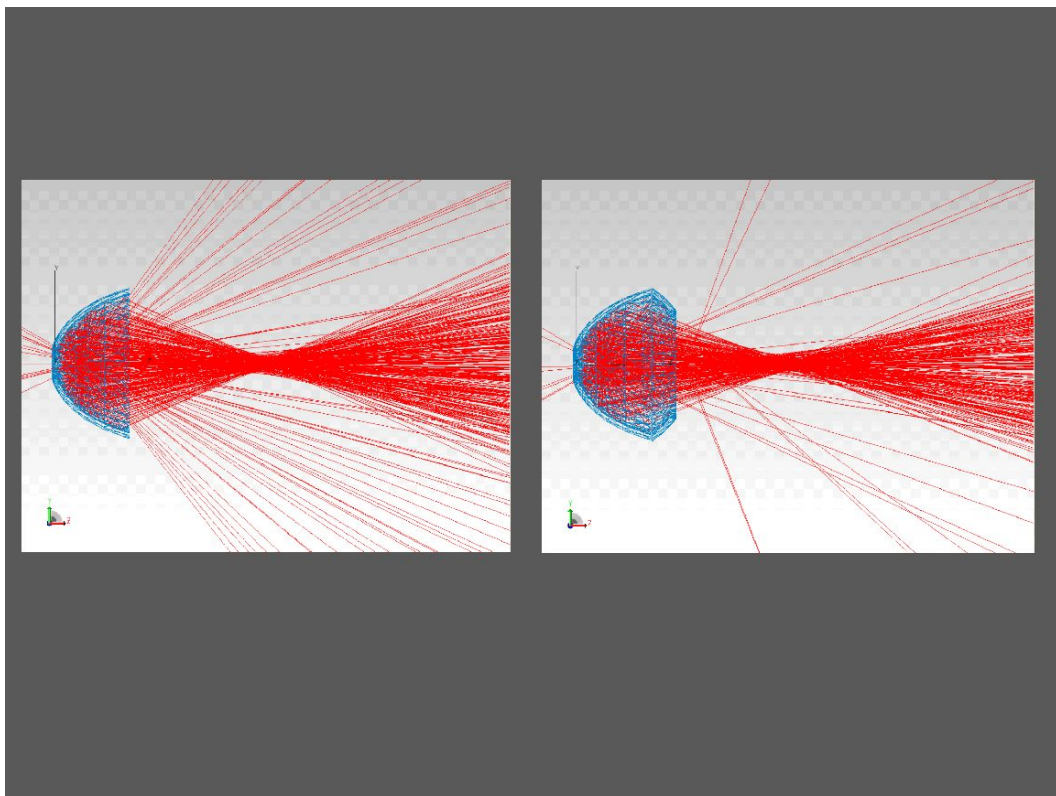

意大利反光碗



## 产品特点

2. 光斑均匀:光斑边缘和中心照度比值 $\geq 80\%$

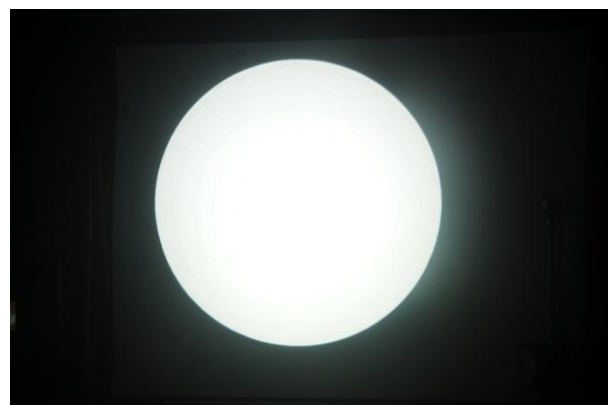



## 产品特点

### 3. 显色指数Ra>95



COMPACT FLUORESCENT

CRI = 51



LED COMPETITORS

CRI = 80



BRIGHTGREEN D900

CRI = 90



## 产品特点

### 4. 调光：均匀、平滑、细腻，低亮度起光，无闪烁

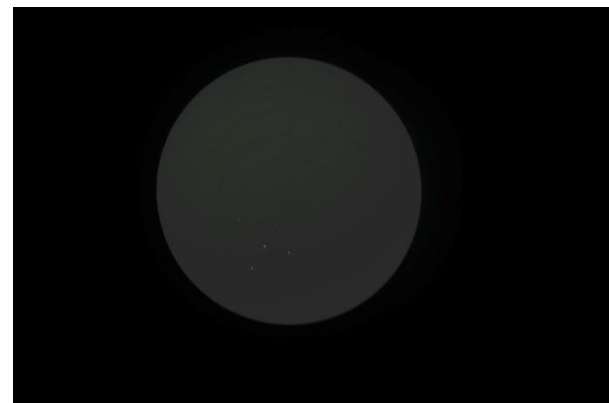
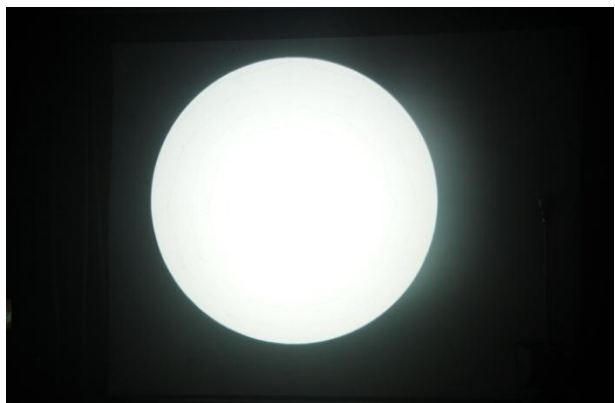

# 产品特点

## 丰富的颜色系统

CMY+CTO



固定颜色盘



# 产品特点

FINE 1400ZL/CF系列

## 图案清晰锐利，光束感强

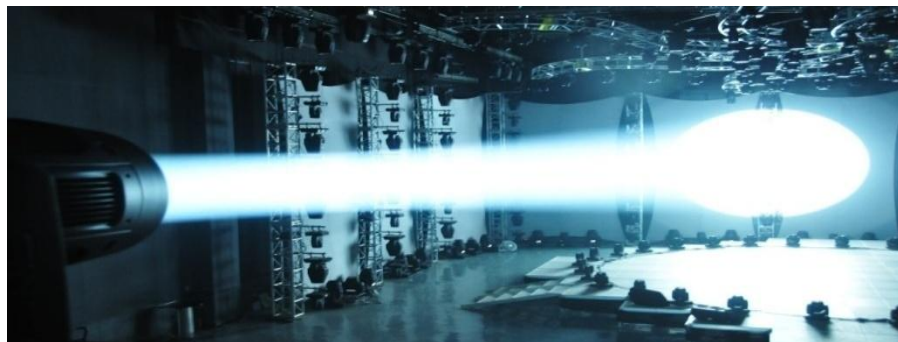

# 产品特点

FINE 1400ZL/JD PERF

## 5. 1光斑可控:全程切割

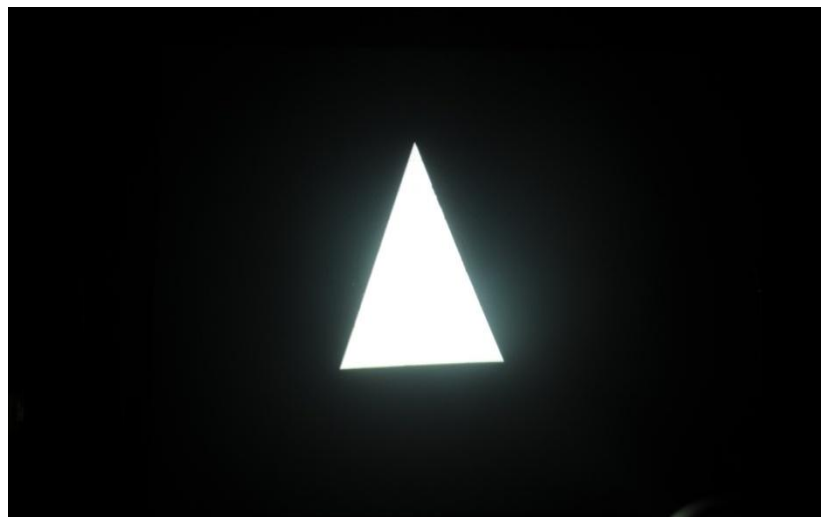
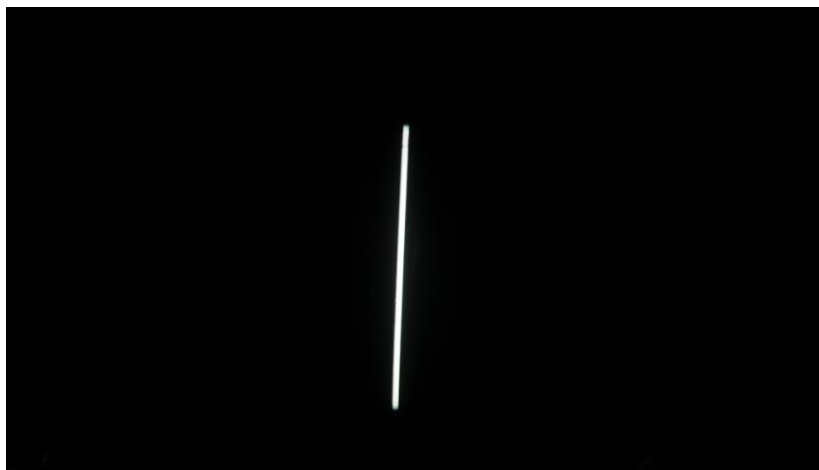



# 产品特点

FINE 1400ZL/JD PERF

## 5.2光斑可控：切割图形四边清晰，可以90°旋转

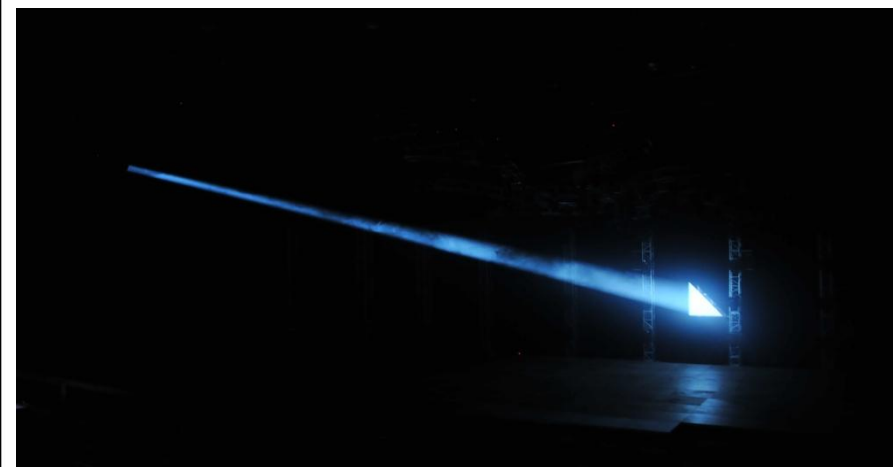
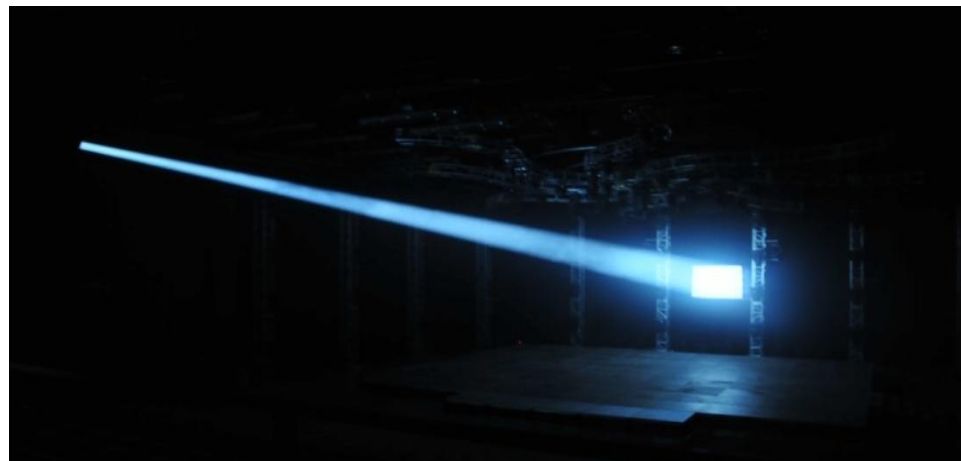

# 产品特点

## 5.3 光斑可控



## 产品特点

### 6. 光学透镜线性变焦，平滑，无突变，无亮心

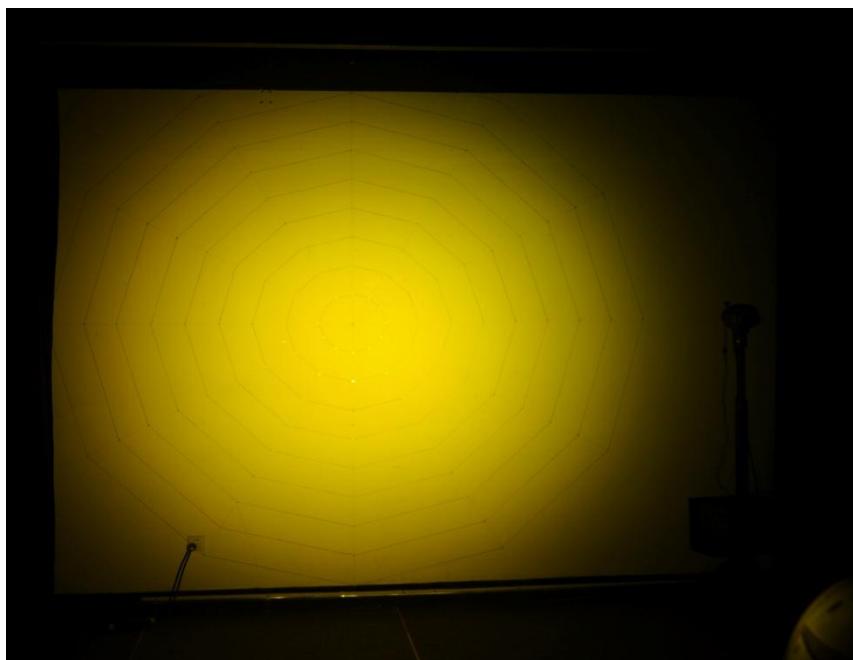

## 产品特点

### 7. 编码器定位，定位精确，断电后自动记忆位置

光耦盘定位

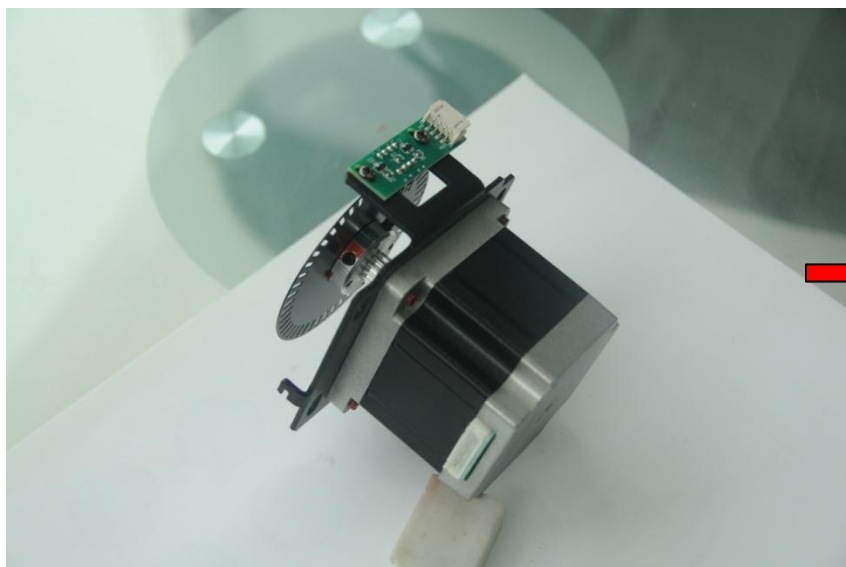

编码器定位

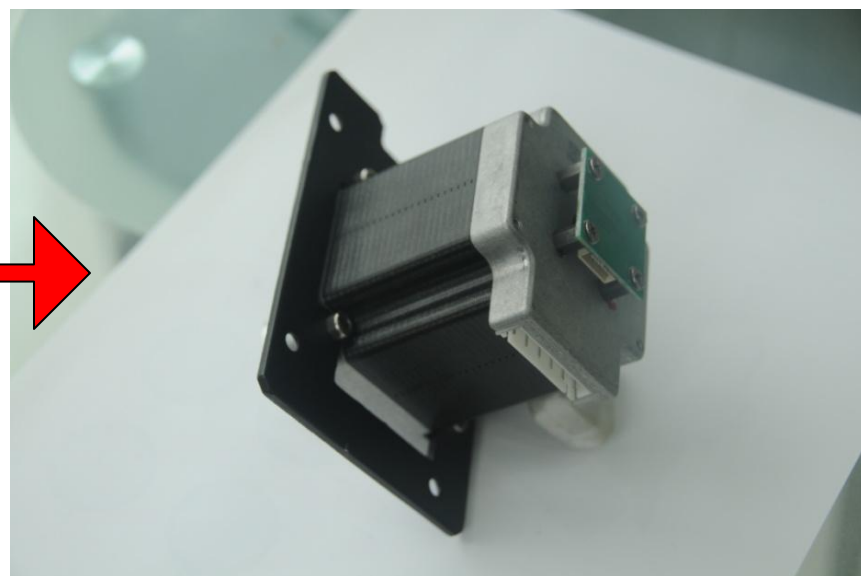

## 产品特点

**台湾EPE**

**8.电源：美国CCI公司电子整流器，效率高，功耗低，发热量小，可线性调控电流，对电网无干扰。**





# 产品特点

FINE 1400ZL/JD系列

## 9. 模块化结构设计，一灯两用，SPOT与PERF模组快速互换。

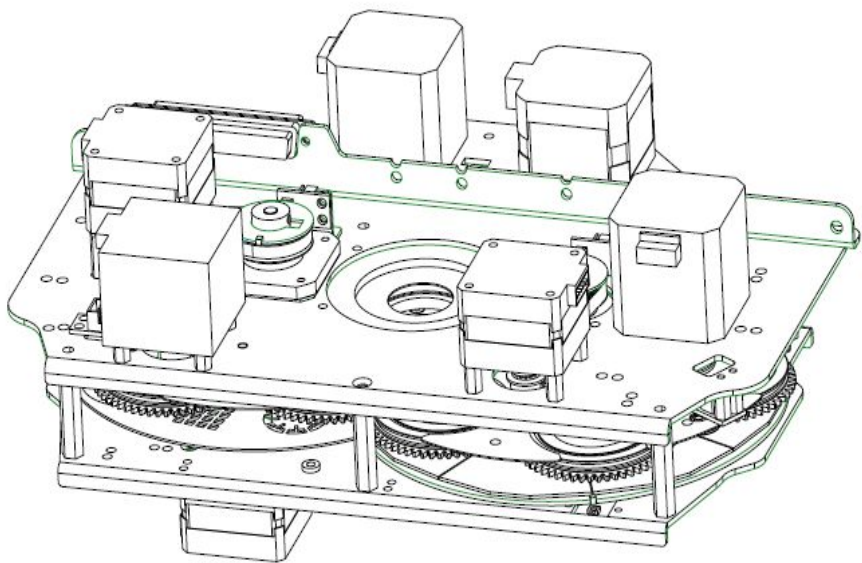

**SPOT图案组件**

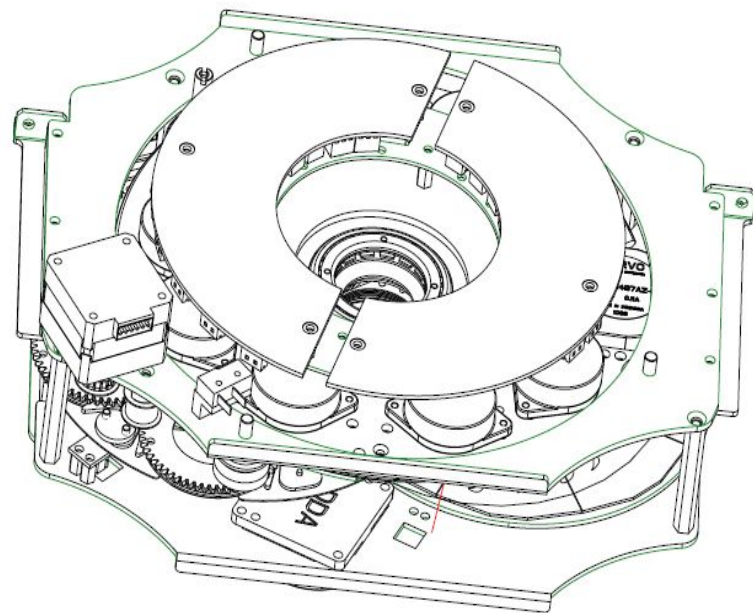

**PERF切割组件**



## 产品特点

10. 智能风机控制，智能检测灯体内部温度，动态控制风扇转速。

11. RDM、DMX、无线DMX、以太网多种通讯协议



# 光学参数

## 光学参数对比表

灯具型号	FINE 1400ZL SPOT	FINE 1400ZL PERF	FINE 1400ZL WASH	FINE 1400ZL WASH PERF
光通量	35000lm	35000lm	41860lm	40000lm
光效	21.9lm/W	21.9lm/W	24.8lm/W	23.3lm/W
色温	6000K	6000K	6000K	6000K
显色指数	> 95	> 95	> 95	> 95
变焦角度	8 ~ 50°	8 ~ 50°	10 ~ 40°	11 ~ 58°



# 彩熠之星 (经典版)



- ◆ FINE 1400JD SPOT
- ◆ FINE 1400JD PERF
- ◆ FINE 1400JD WASH-PERF
- ◆ FINE 1400JD WASH



# 产品特点

## 1. 高光效：主副反光碗设计，光效利用率提高10%

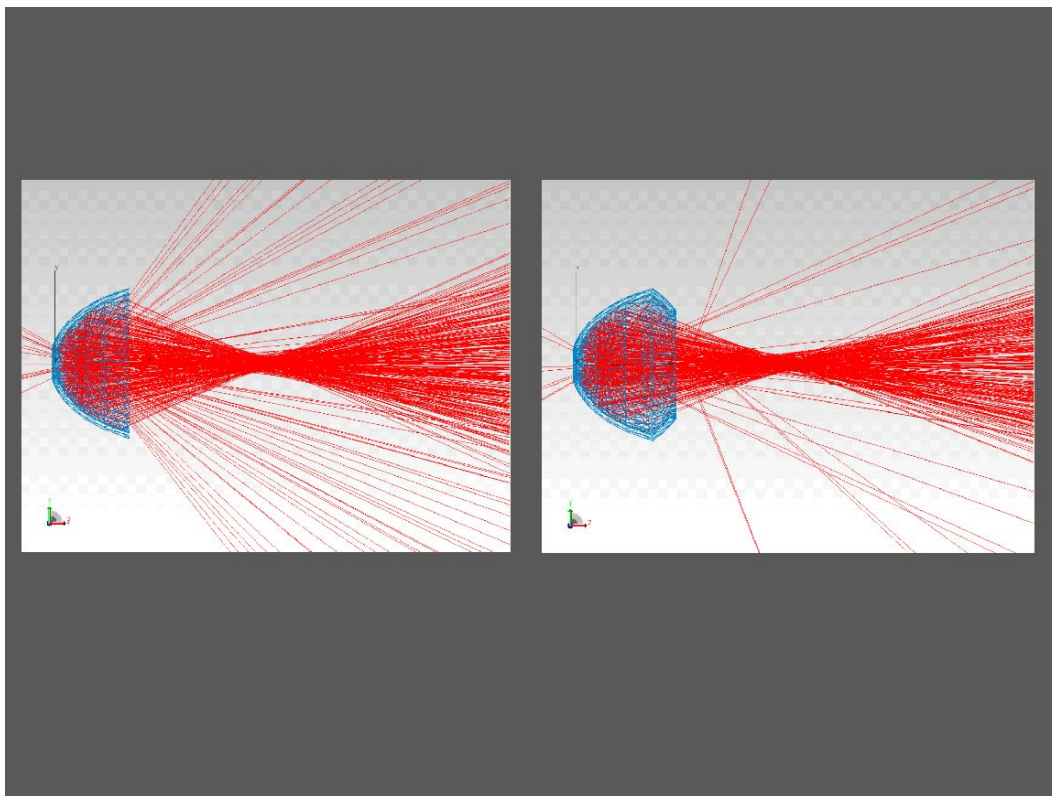

德国AUER反光碗





## 产品特点

**7.电源:美国CCI公司电子整流器,效率高,功耗低,发热量小,可线性调控电流,对电网无干扰。**



# 光学参数

## 光学参数对比表

灯具型号	FINE 1400E SPOT	FINE 1400E PERF	FINE 1400E WASH	FINE 1400E WASH PERF
光通量	35000lm	35000lm	41860lm	40000lm
光效	21.9lm/W	21.9lm/W	24.8lm/W	23.3lm/W
色温	6400K	6400K	6400K	6400K
显色指数	> 95	> 95	> 95	> 95
变焦角度	10 ~ 50°	10 ~ 50°	10 ~ 40°	11 ~ 58°

**是否改JD后保留**



# 彩熠之星（超凡版）

◆ FINE 1400CF SPOT

◆ FINE 1400CF PERF



## 产品特点

出光镜头直径：188mm，变焦范围：6-50°

光通量输出：35000lm

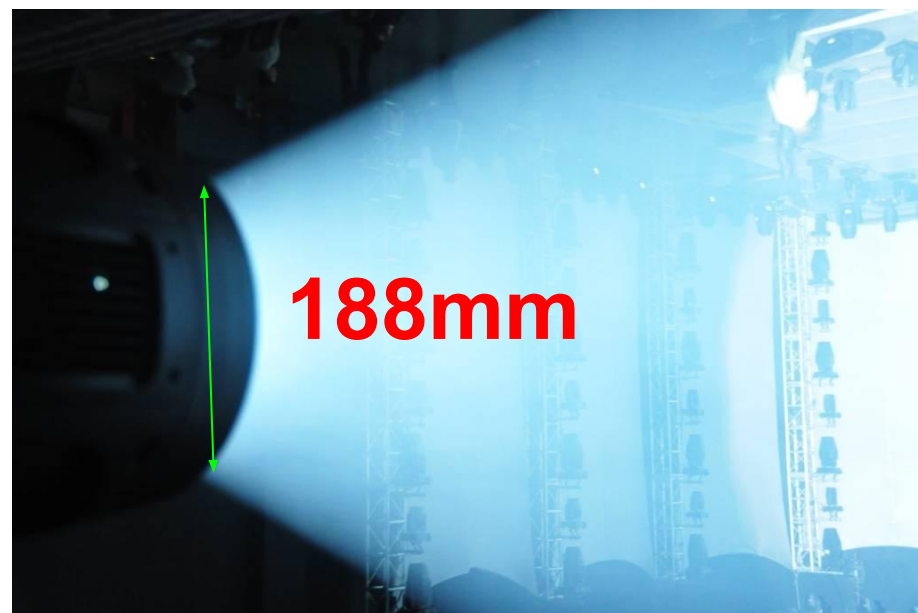
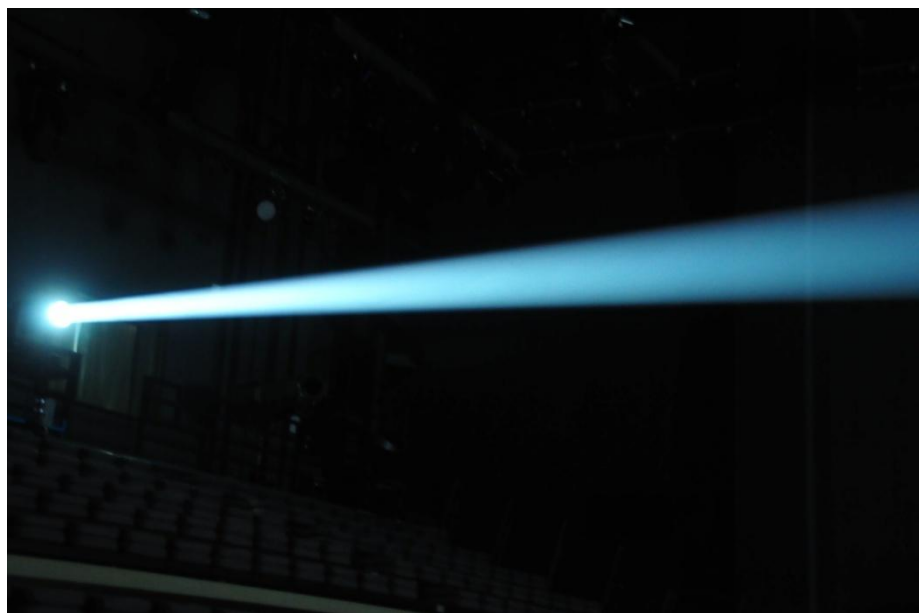

# 产品特点

## 丰富的图案系统

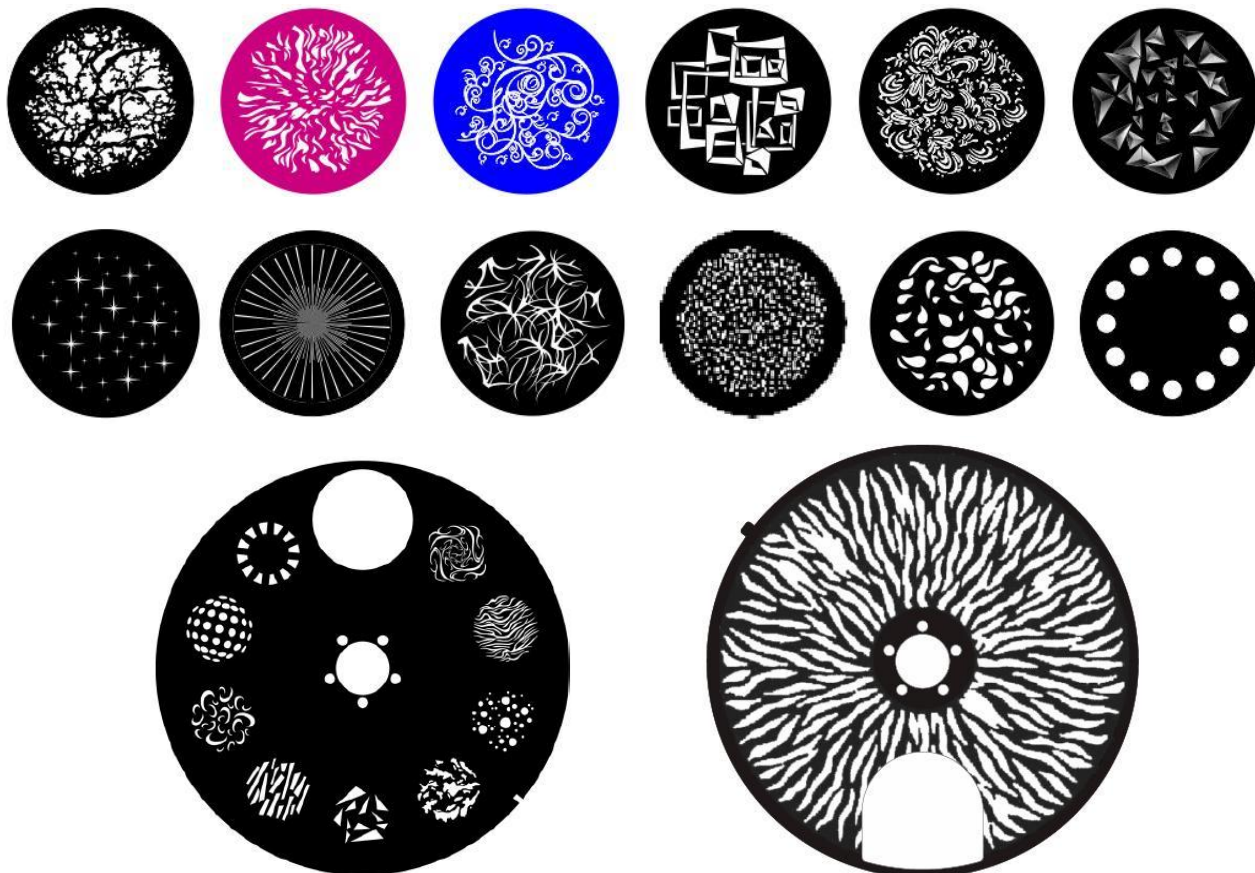



# 产品特点

丰富的图案系统

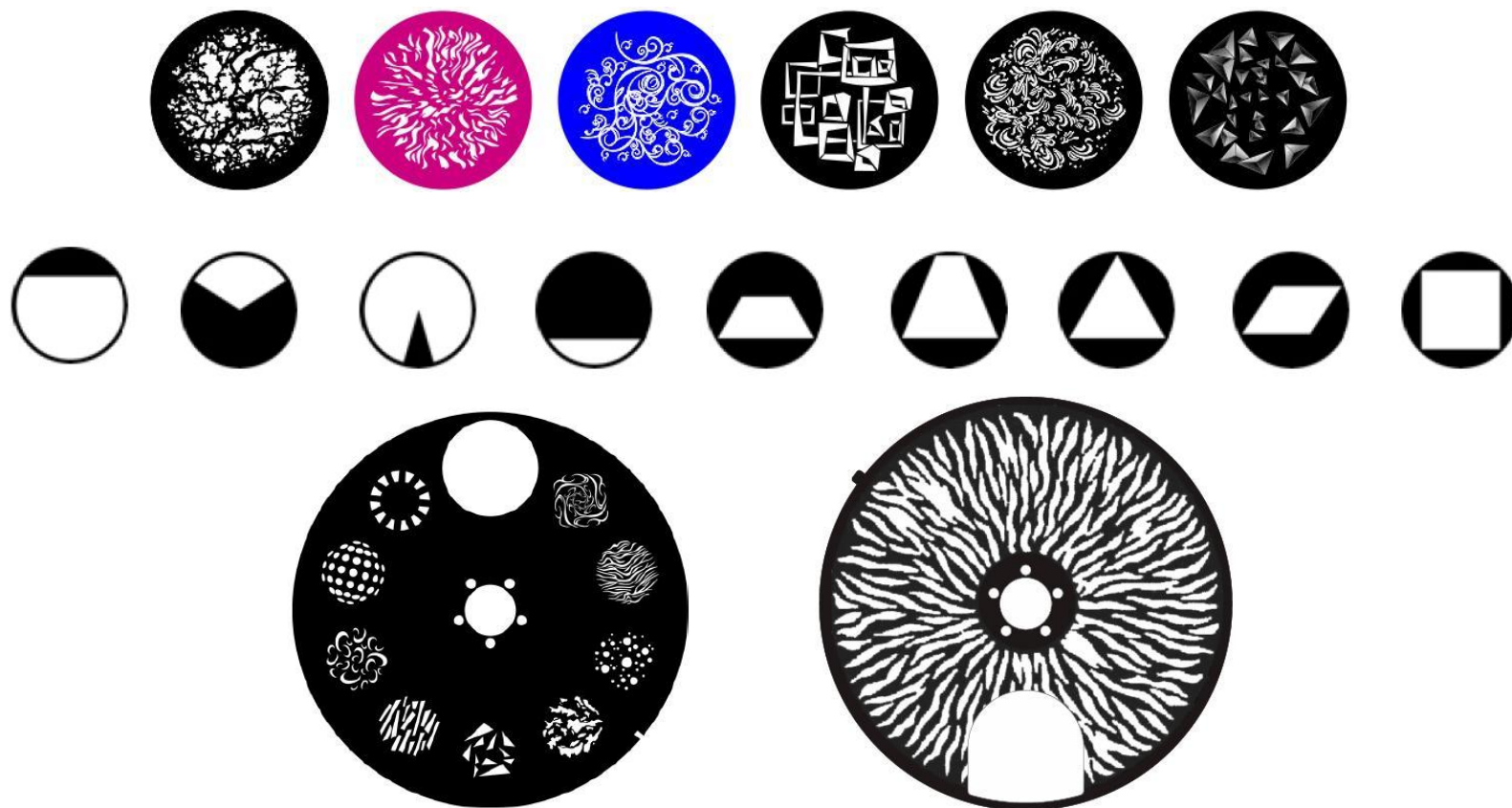

## 产品特点

出光镜头直径：188mm

整机光通量输出：35000lm

光束穿透力强劲；



# 产品特点

小角度雾化

大角度雾化

独立两档雾化柔光  
效果，可叠加使用

一个旋转的四面棱  
镜，可双向旋转

旋转四棱镜



# 照度表

W光照度(lux)

B光照度(lux)

G光照度(lux)

R光照度(lux)

混白光照度(lux)

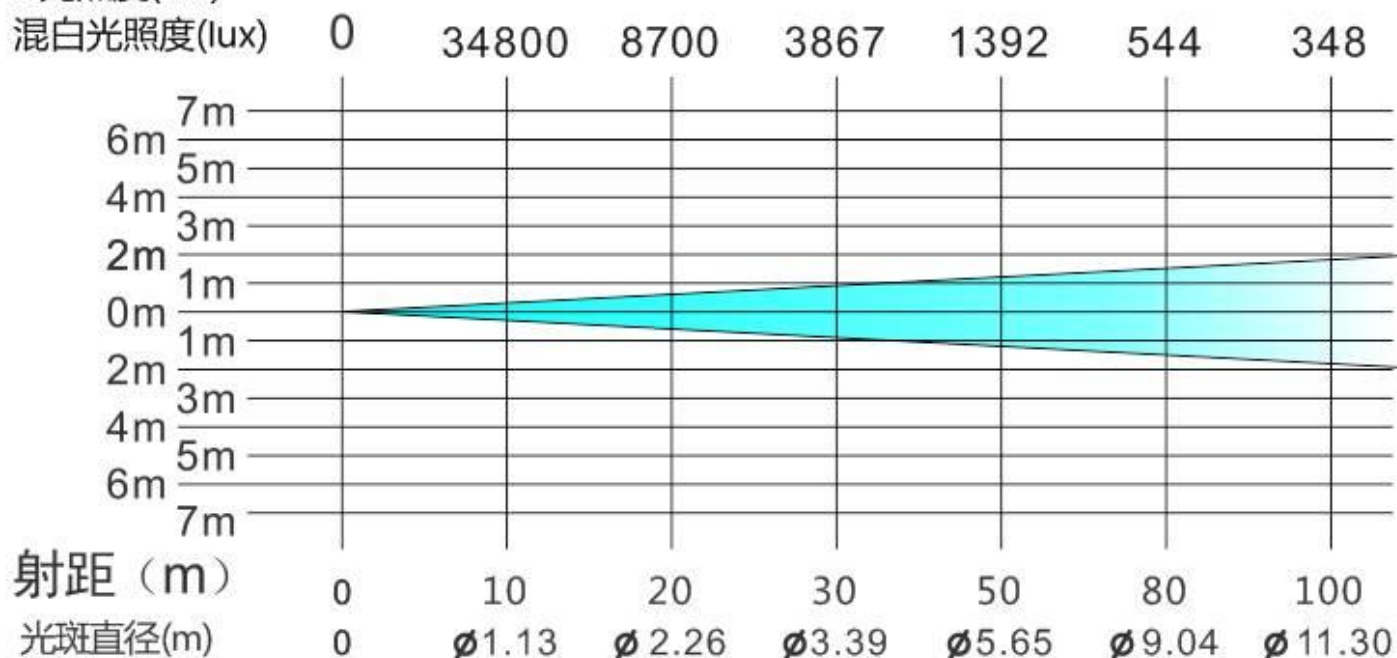

## ZL、JD、CF三个型号的主要区别

材料差异	<b>ZL</b>	<b>JD</b>	<b>CF</b>
反光碗	意大利ODL	德国AUER	德国AUER
整流器	台湾EPE	美国CCI	美国CCI





# FINE 470 BSW/BEAM

灯泡: PHILIPS MSD Platinum 20 RB



## 产品特点

1. 出光镜头直径: 174mm

整机光通量输出: 18000lm

光束穿透力强劲;



## 产品特点

2. 出光镜头直径: 178mm

整机光通量输出: 20000lm

光束穿透力强劲;



## 产品特点

3. 三合一功能，变焦范围：

**BEAM: 0.3~2.5 °;**

**SPOT: 4 ~ 50 °(自动对焦);**

**Wash: 11 ~ 28°**

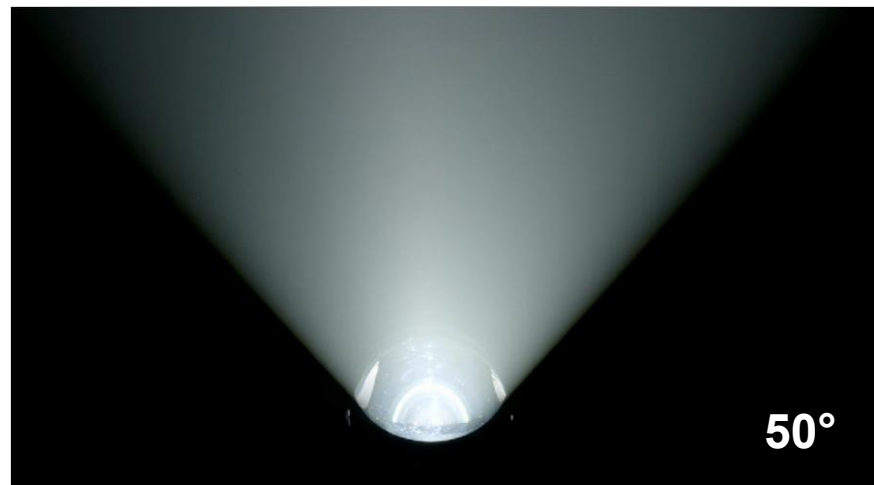
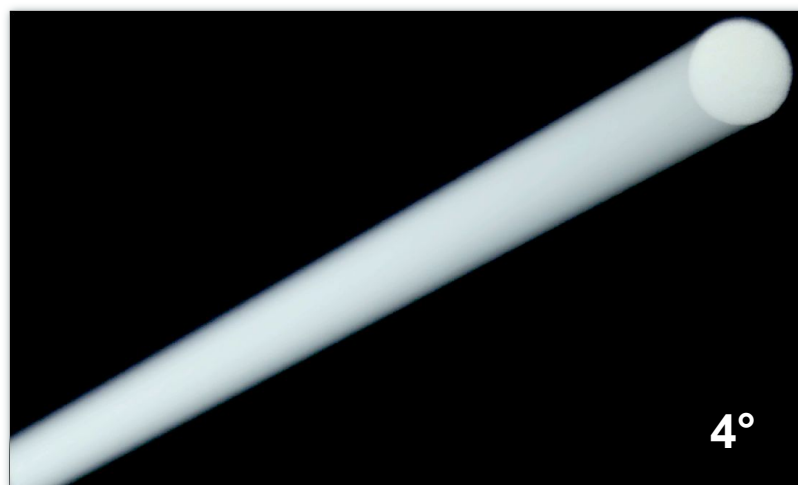

## 产品特点

4. 变焦范围: BEAM:  $0\sim 4^\circ$

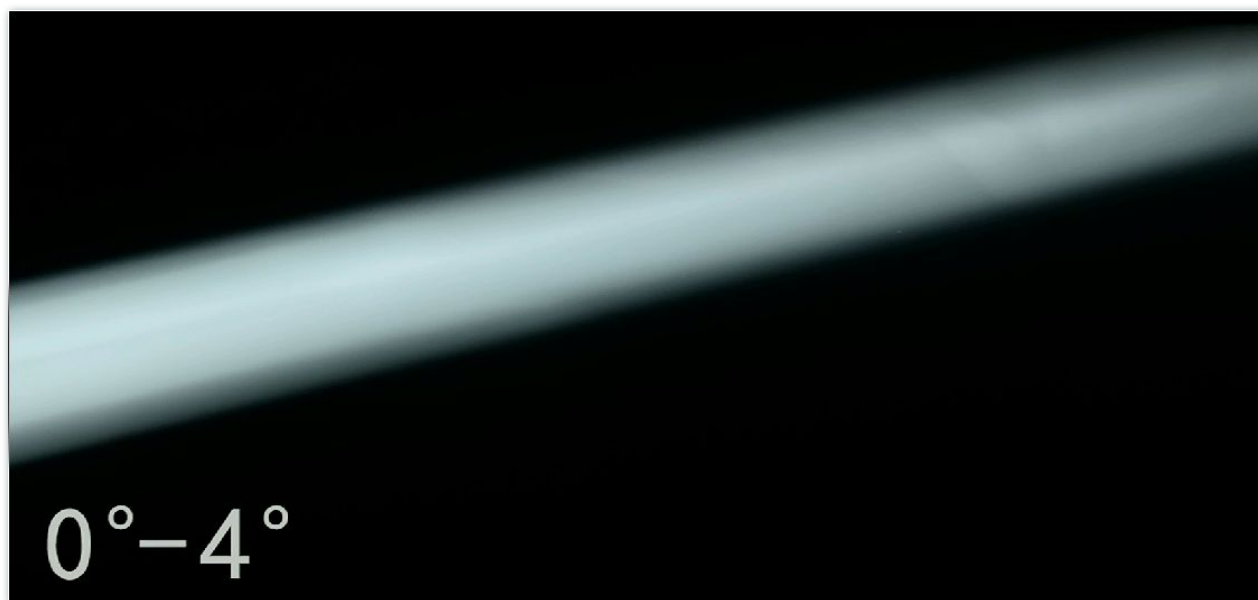



# 产品特点

## 5. 丰富的颜色系统

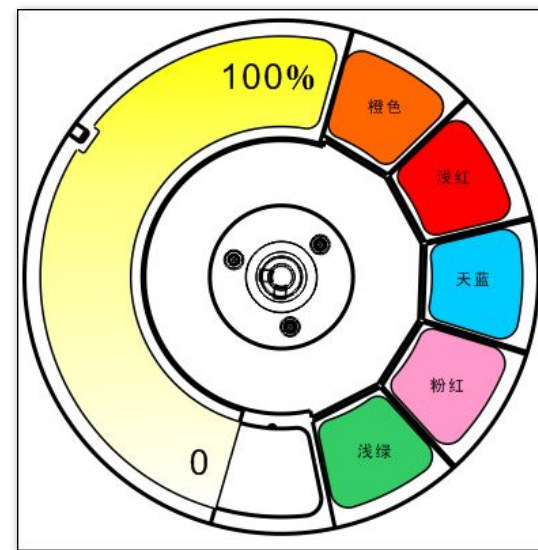
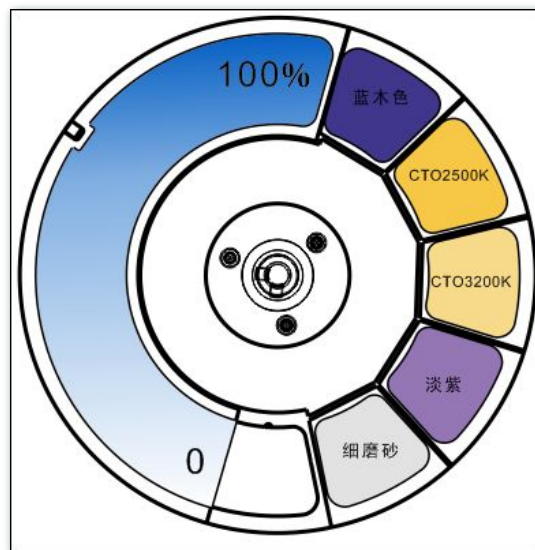
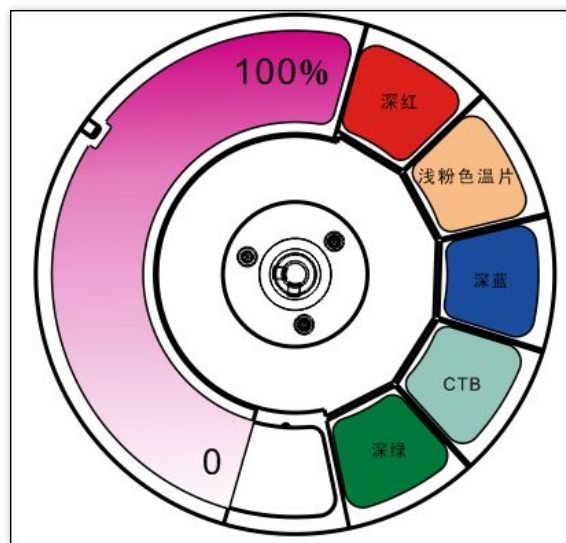

# 产品特点

## 6. 丰富的效果配置;

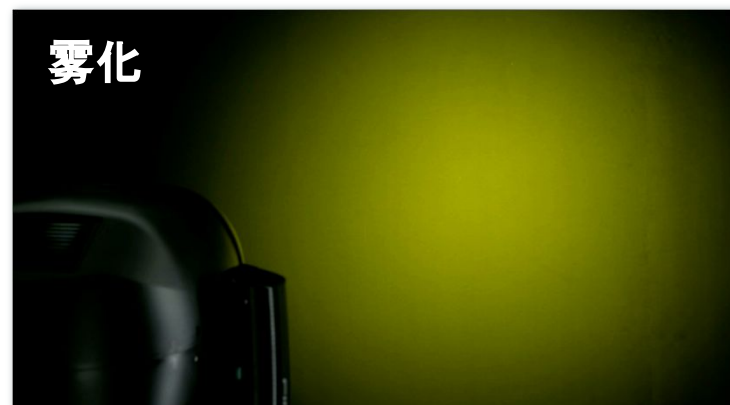
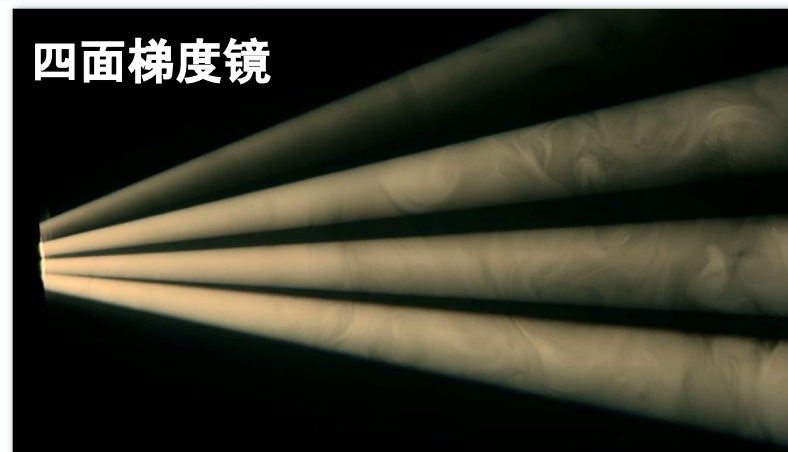
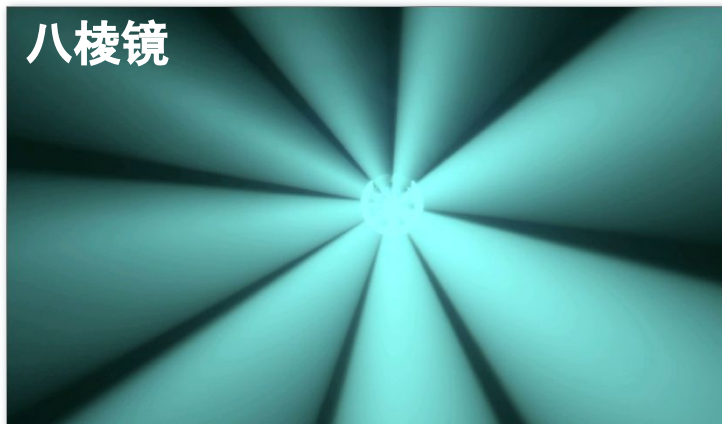

# FINE 470 BEAM

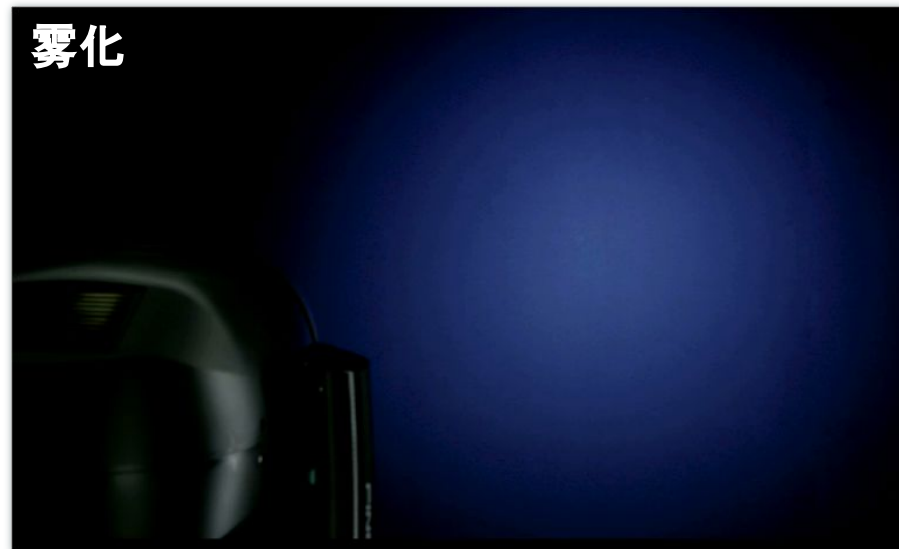
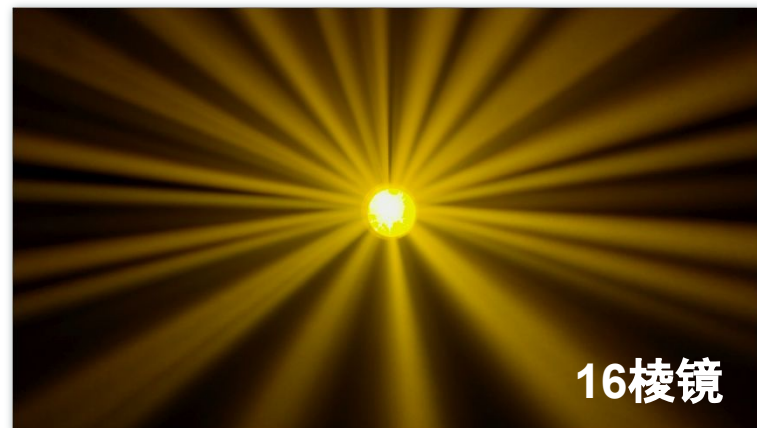
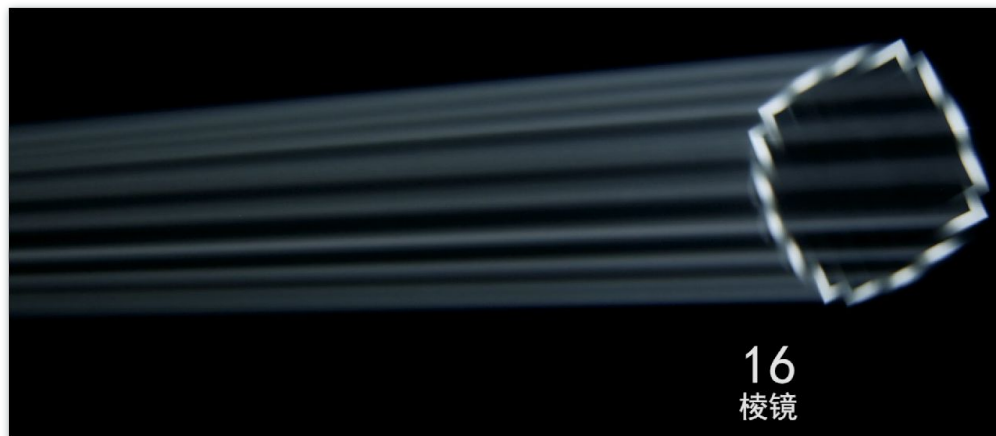



# 产品特点

## 7.1 专利技术的算法，XY轴运行速度快



# 产品特点

7.2 专利技术的算法，XY轴运行速度快

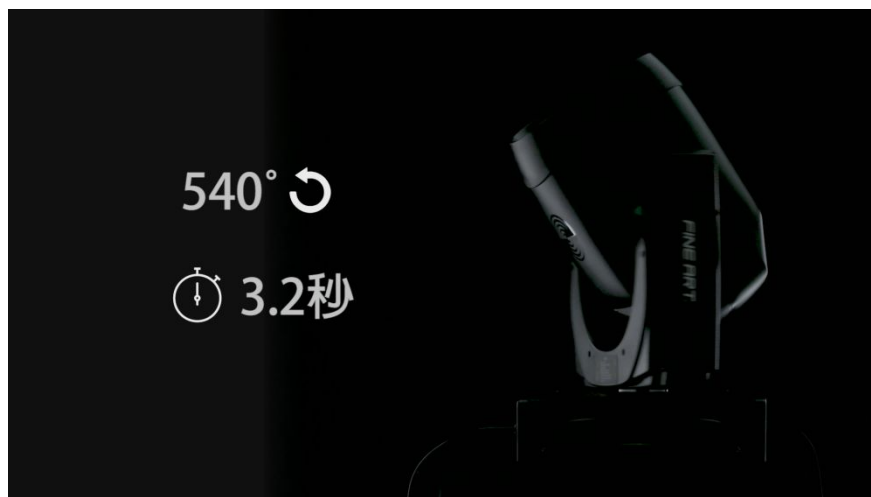

**X轴**

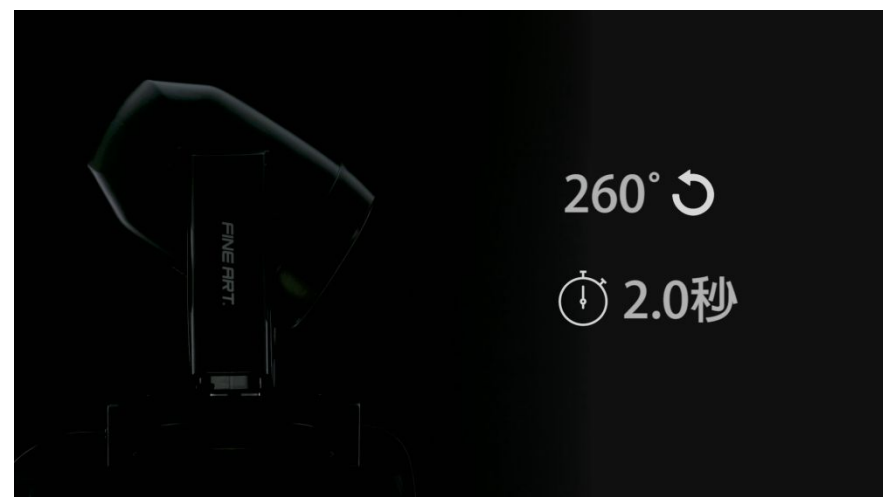

**Y轴**





## 产品特点

### 8. 编码器定位，定点精准可靠，具有断电自动记位功能

绝对零定位

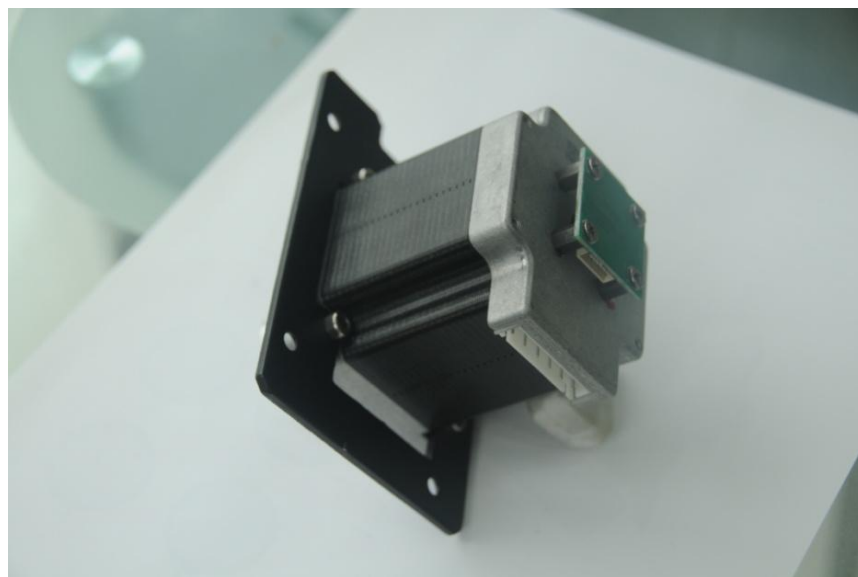

## 厂家认证, 无后顾之忧

# PHILIPS

致: 广州彩熠灯光有限公司  
自: 飞利浦照明(中国)投资有限公司  
有关: 飞利浦 MSD Platinum 20 RB 灯泡温度认证

---

尊敬的客户:

您好! 我们很高兴地通知您, 贵司采用的飞利浦 MSD Platinum 20 RB (功率 470W) 灯泡在贵司灯具 FINE470 系列 (FINE 470BSW、FINE 470BEAM) 内的温度测试结果:

在正放、倒挂、侧挂等状态下, 模拟用户各种不同使用方式, 灯泡球体、T 点、F 点、R 点等处温度均在飞利浦要求的范围内, 同时也通过了相应的老化测试。

综合考量, 认定贵司的 FINE470 系列灯具散热系统设计符合飞利浦要求, 可以正常投入使用。FINE470 系列灯具使用的 MSD Platinum 20 RB 灯泡、配套 20 RB 镇流器均可享受飞利浦提供相应的保修服务。

特此认证!



飞利浦舞台照明全球产品市场经理  
飞利浦照明(中国)投资有限公司  
2016-11-25



# 防水灯具介绍



**FINE 470BSW/BEAM OD**



# FINE 470 OD 系列

**FINE 470 BSW OD**  
**FINE 470 BEAM OD**  
一款全天候户外摇头灯，  
防水等级达到IP65

表示完全防止粉尘进入

表示任何角度低压喷射无影响



# FINE 470 BSW /BEAM OD

灯泡: MSD Platinum 21 R 金卤杯泡

灯泡: OSRAM SIRIUS HRI 440W





## 产品特点

出光镜头直径：174mm

整机光通量输出：20000lm

光束穿透力强劲；



# 产品特点

## 照度表和投射距离

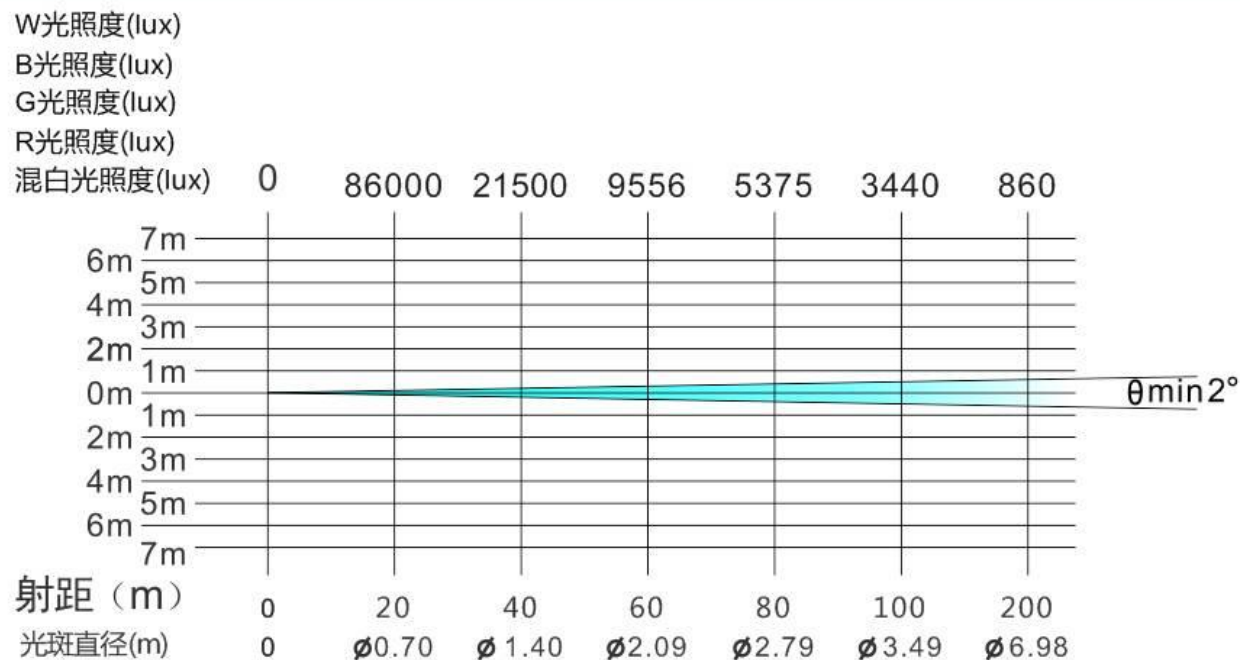

## 产品特点

三合一功能，变焦范围：

**BEAM&SPOT: 2 ~ 40°**

**Wash: 3 ~ 48°**

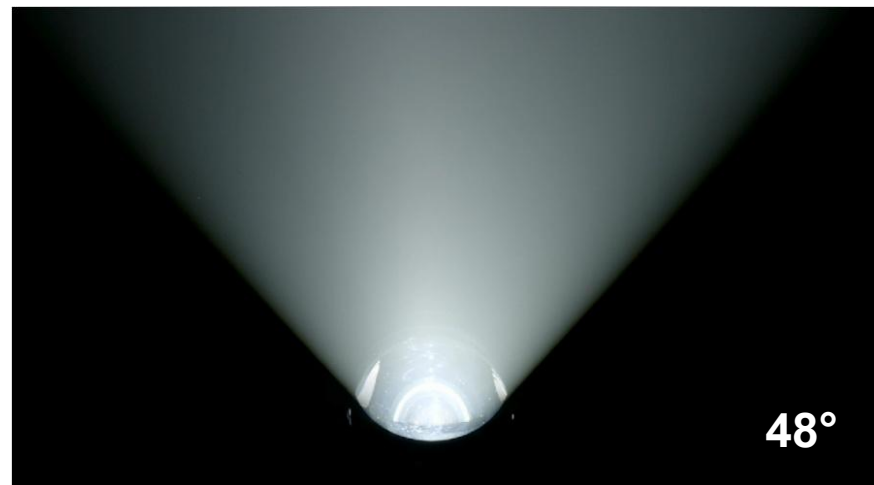
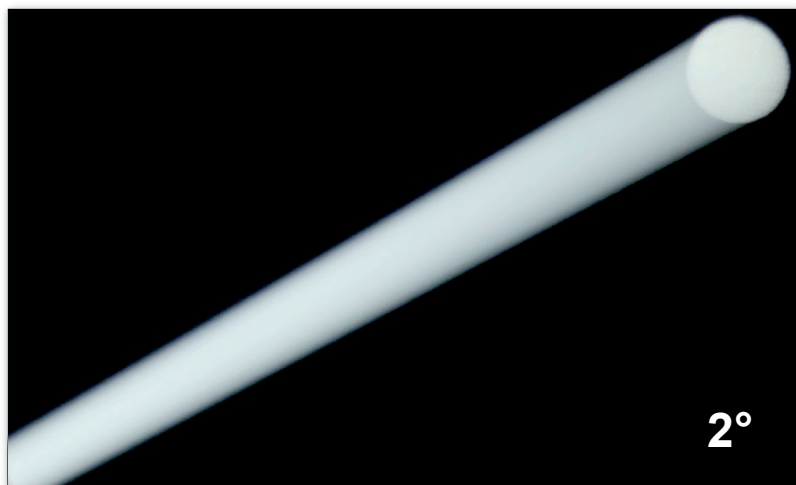

# 产品特点

## 丰富的颜色系统

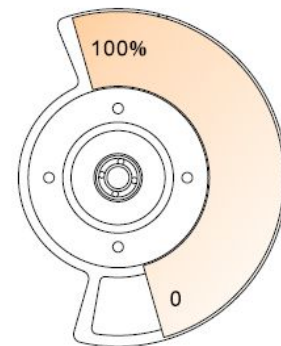
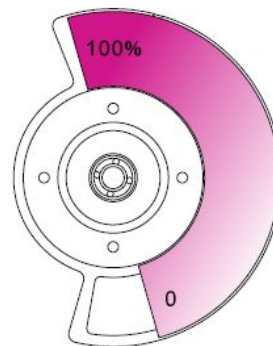
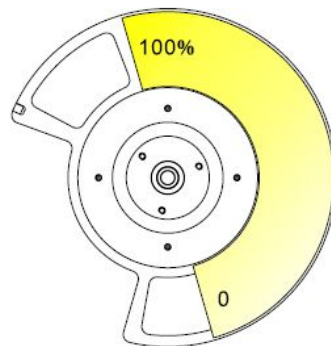
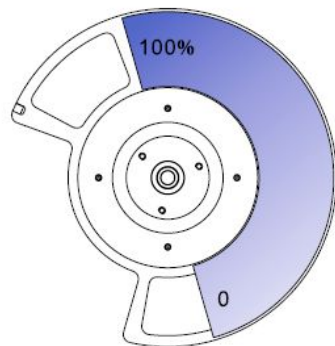

# 产品特点

丰富的图案系统

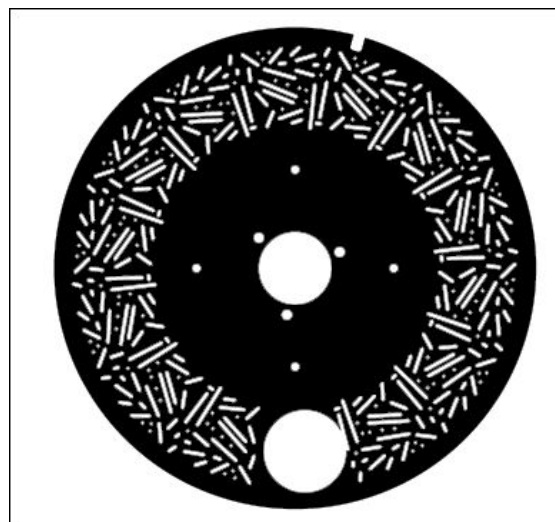
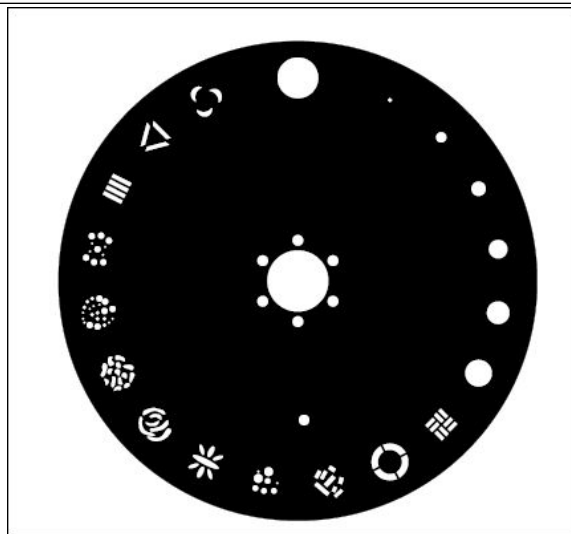



# 产品特点

丰富的效果配置；

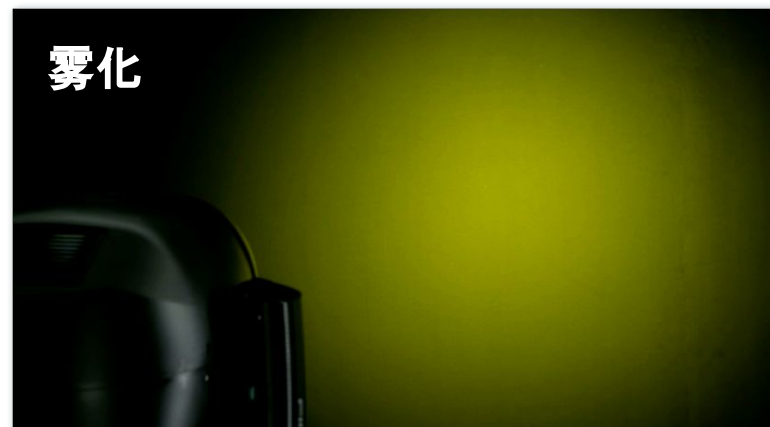
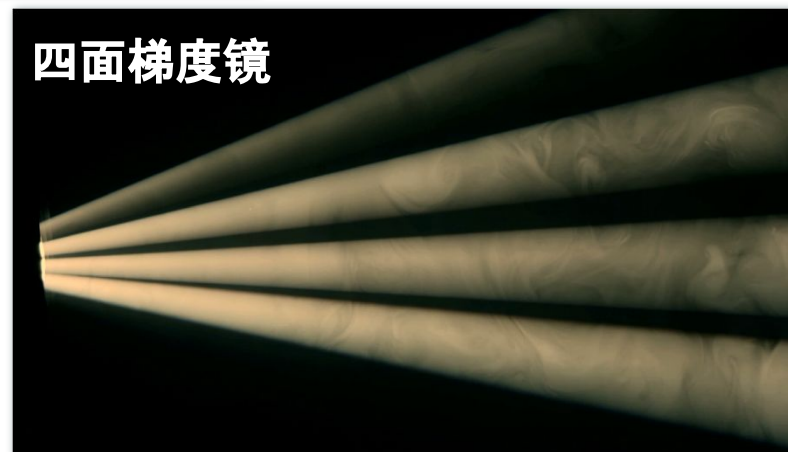
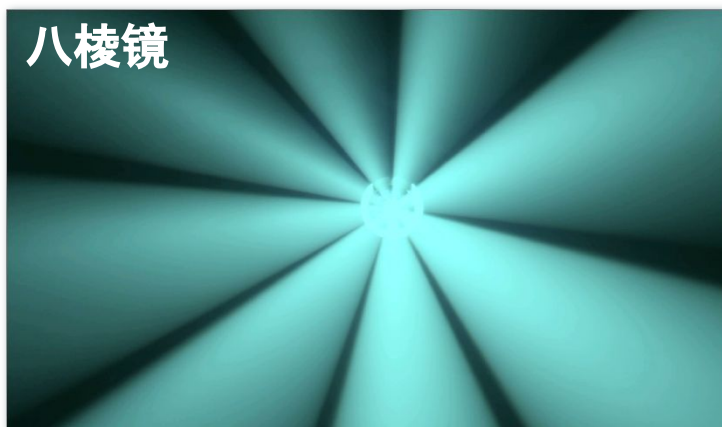

## 产品特点

出光镜头直径：178mm

整机光通量输出：20000lm

光束穿透力强劲；



## 产品特点

变焦范围: BEAM:  $0\sim 4^{\circ}$

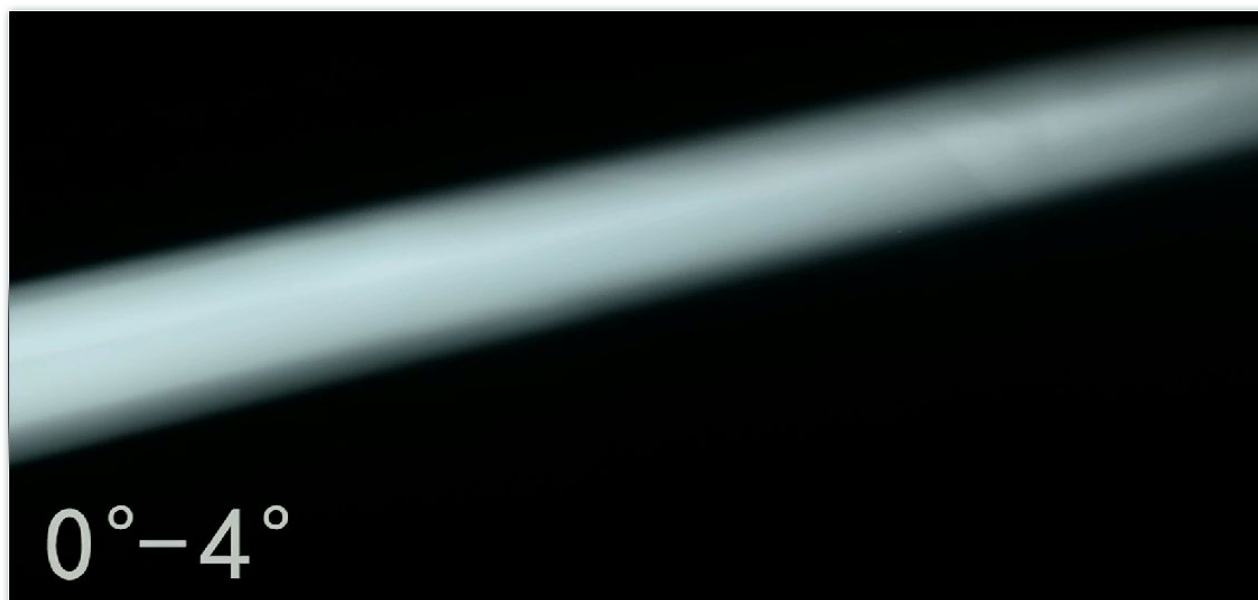

# 产品特点

## 照度表和投射距离

W光照度(lux)

B光照度(lux)

G光照度(lux)

R光照度(lux)

混白光照度(lux)

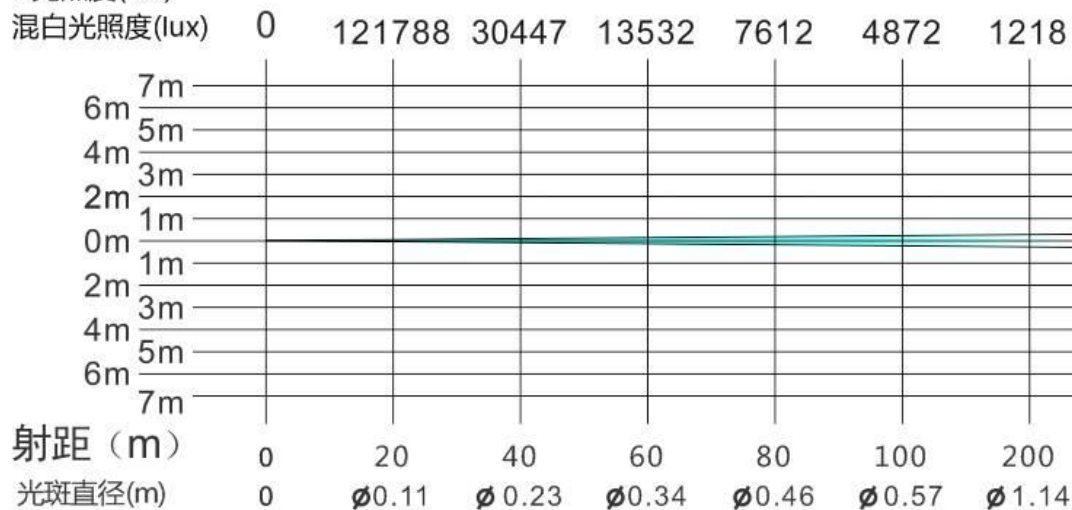

# 产品特点

## 丰富的颜色系统

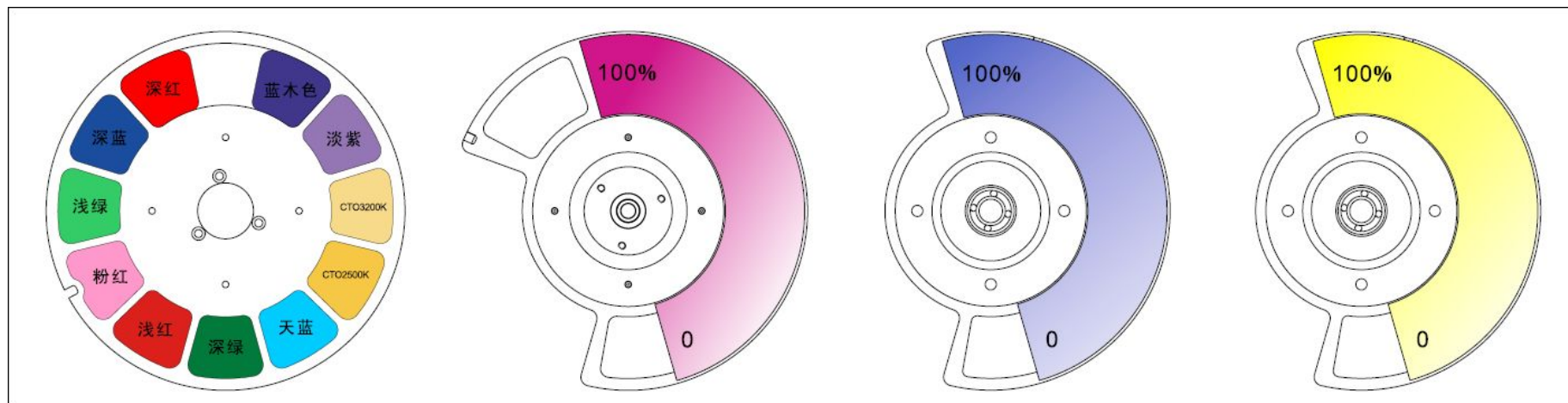



# 产品特点

丰富的图案系统

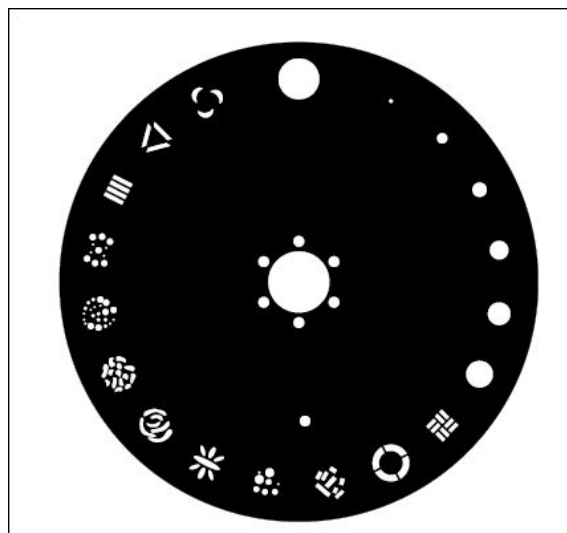
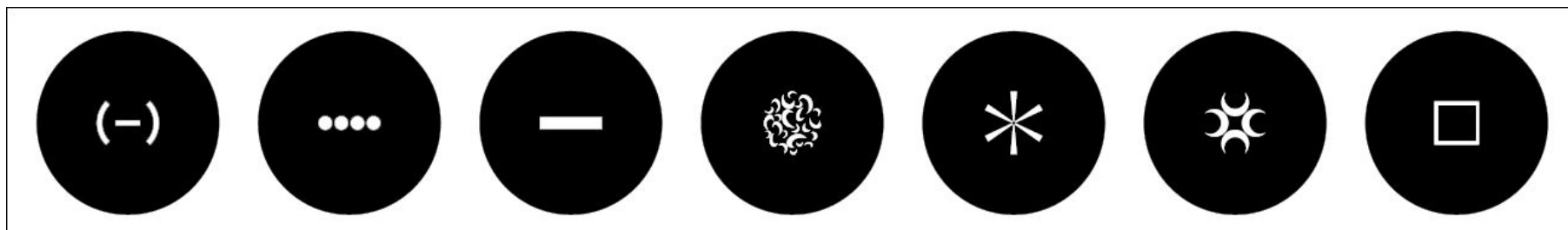

# FINE 470BEAM OD

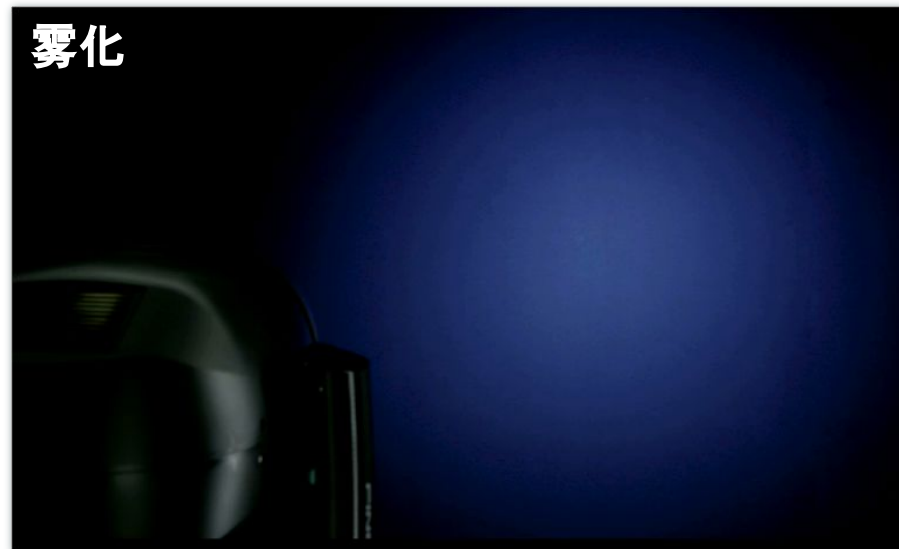
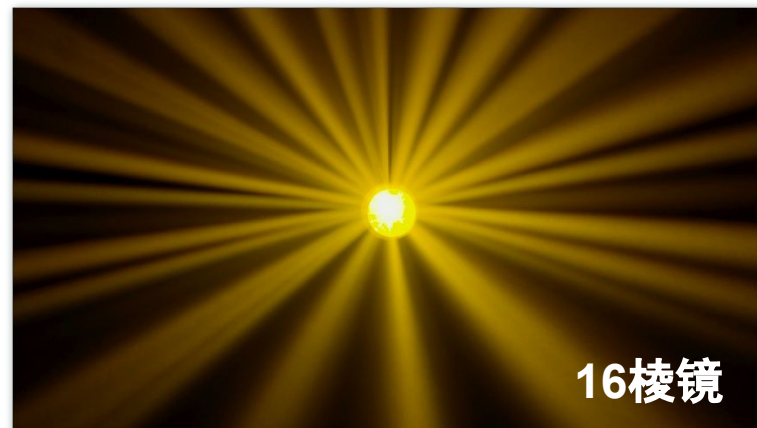
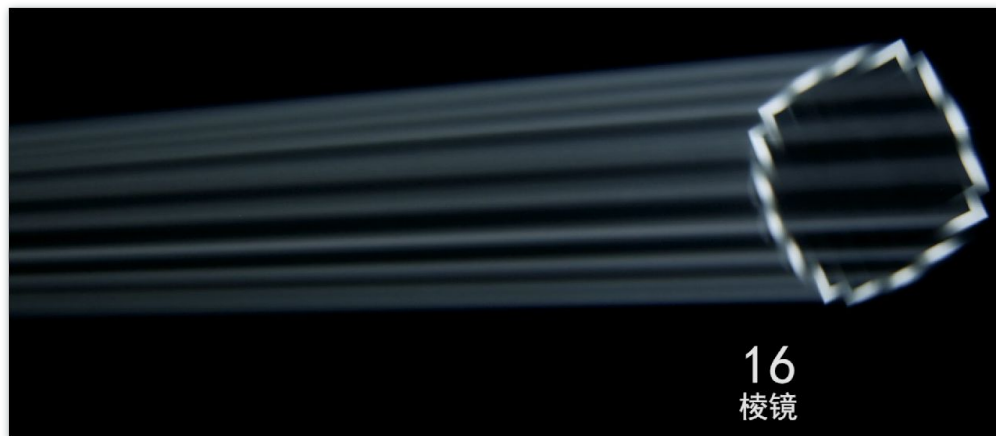

# 产品特点

专利技术的算法，XY轴运行速度快

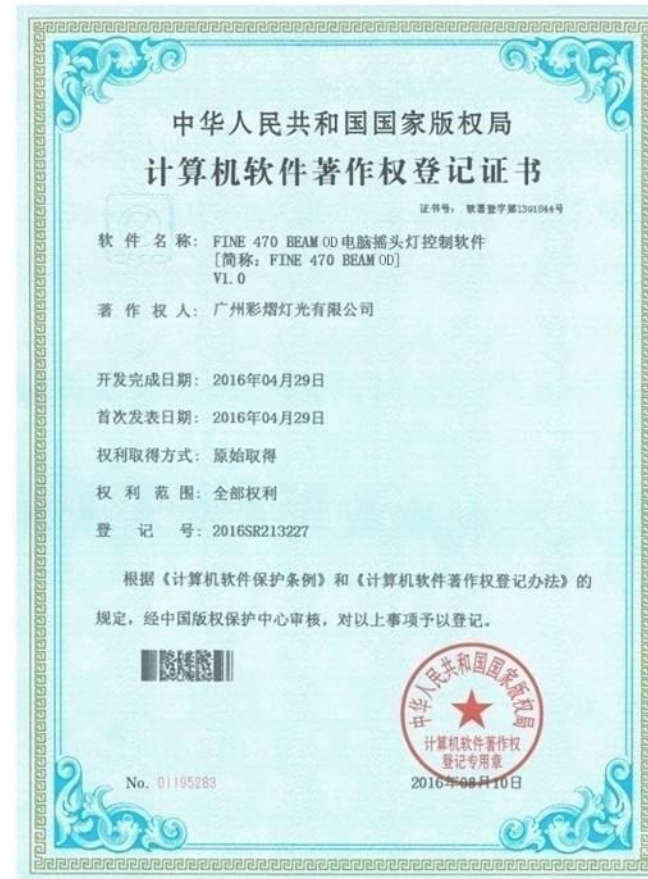
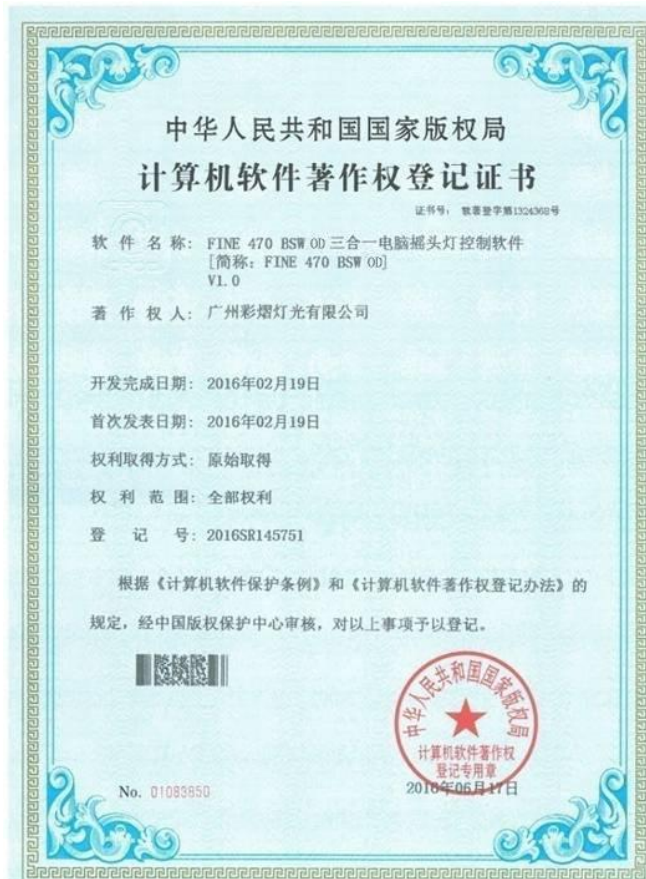

# 产品特点

专利技术的算法，XY轴运行速度快



**X轴**



**Y轴**



# 产品特点

**编码器定位，定点精准可靠，具有断电自动记位功能**

绝对零定位

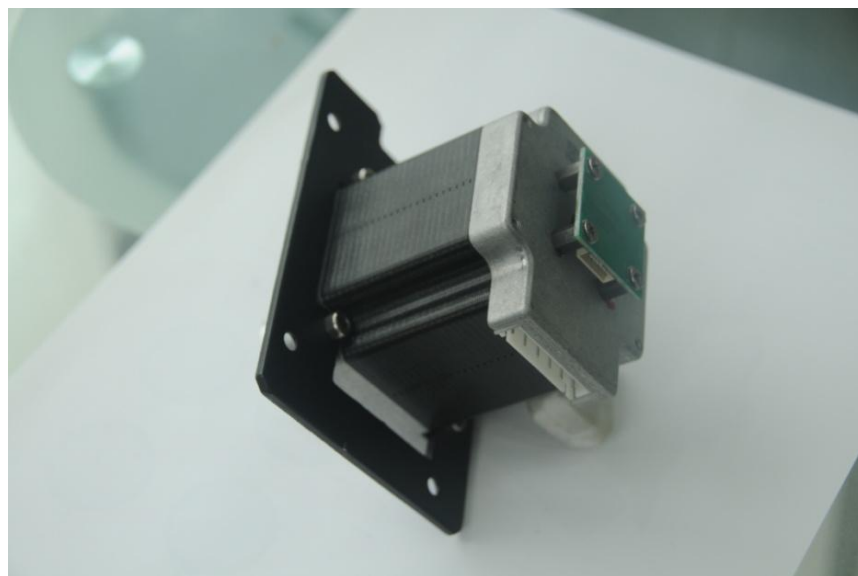



# 厂家认证, 无后顾之忧

## PHILIPS

致: 广州彩熠灯光有限公司  
自: 飞利浦照明(中国)投资有限公司  
有关: 飞利浦 MSD Platinum 21 R 灯泡温度认证

尊敬的客户:

您好! 我们很高兴地通知您, 贵司采用的飞利浦 MSD Platinum 21 R (功率 470W) 灯泡在贵司灯具 FINE470 系列 (FINE 470BSW OD、FINE 470BEAM OD) 内的温度测试结果:

在正放、倒挂、侧挂等状态下, 模拟用户各种不同使用方式, 灯泡球体、T 点、F 点、R 点等处温度均在飞利浦要求的范围内, 同时也通过了相应的老化测试。

综合考量, 认定贵司的 FINE470 系列灯具散热系统设计符合飞利浦要求, 可以正常投入使用。FINE470 系列灯具使用的 MSD Platinum 21 R 灯泡、配套 21 R 镇流器均可享受飞利浦提供相应的保修服务。

特此认证!



飞利浦舞台照明全球产品市场经理  
飞利浦照明(中国)投资有限公司  
2017-08-25

致: 广州彩熠灯光有限公司

## OSRAM

OSRAM-SP-2017-16PIA

自: 欧司朗(中国)照明有限公司

有关: OSRAM SIRIUS 440W S 温度承认

尊敬的客户:

您好! 我们很高兴的通知您。

贵司采用 OSRAM SIRIUS 440W S 灯泡在灯具(FINE 440 BSWOD/FINE 440 BEAM OD)内温度测试结果:

在水平或垂直状态下, 灯球, 前引线, 前铝片及后铝片温度均在规格范围内, 同时, 也通过了相应的老化测试。

综合考量, 判定灯具(FINE 440 BSWOD/FINE 440 BEAM OD)散热系统设计符合 OSRAM 灯泡要求, 可正常投入使用。

具体测试数据见测试报告。如贵司后续有任何散热方面的设计变更, 请通知我司再次确认, 以确保灯泡工作在额定的温度范围内, 否则产品(灯泡和镇流器)将会失去保修资格。

如果您对此事件有任何疑问, 请随时和我们联系!



欧司朗(中国)照明有限公司  
有限公司

2017-08-19



# LED灯具介绍

**FINE 1537 PIXIE**

**FINE 850C/W STROBE**

**FINE 400CL**



# LED 摇头灯系列



**FINE 1537 PIXIE**



# FINE 1537 PIXIE

**FINE 1537 PIXIE**是一款创新LED摇头灯具，具有光束，染色效果，高品质OSRAM RGBW四合一LED灯珠为光源，单颗可控，4~60 ° 变焦。

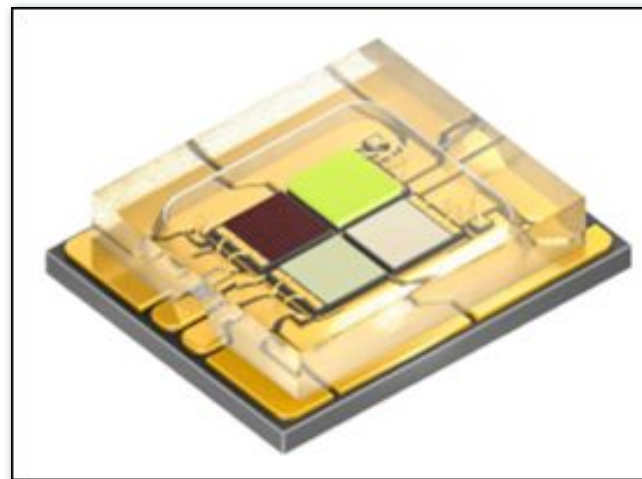
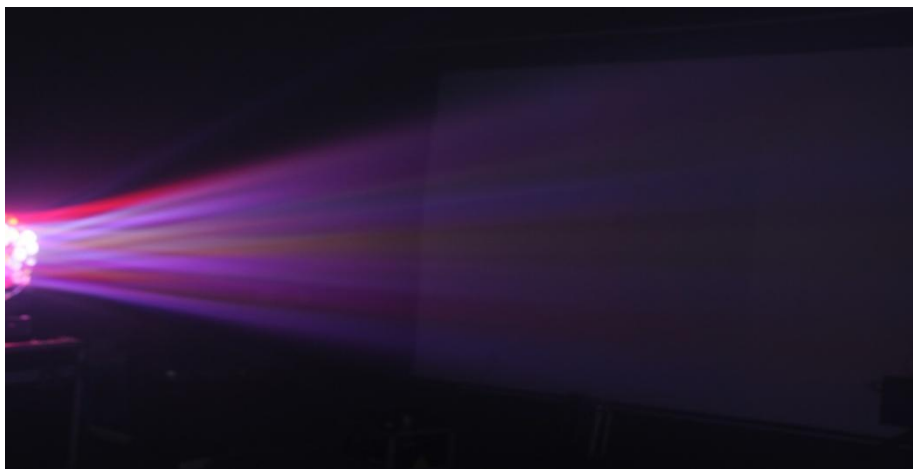

# 产品亮点

## 4-60°光束及染色效果

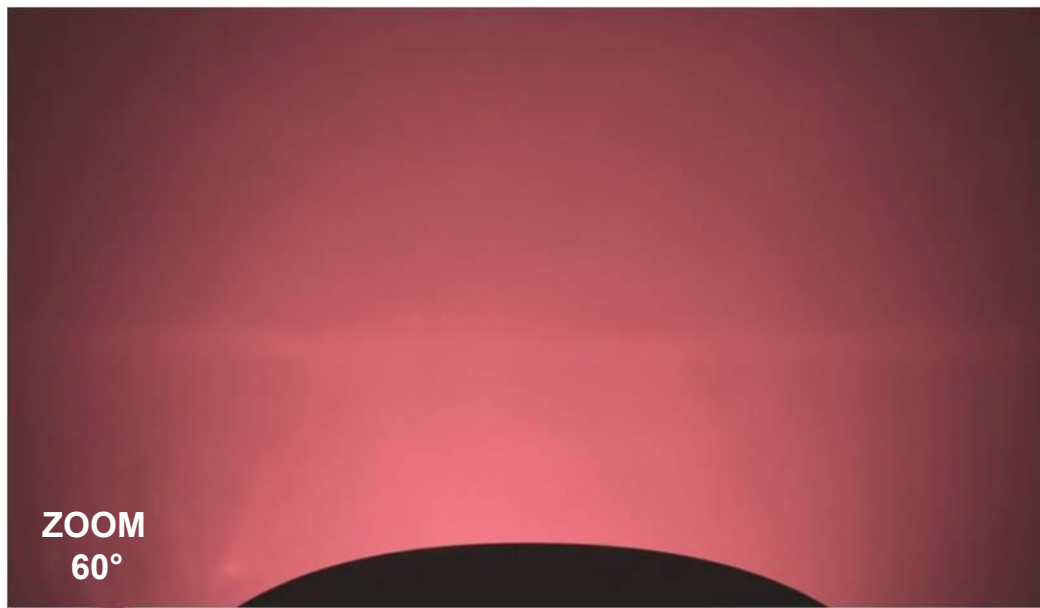
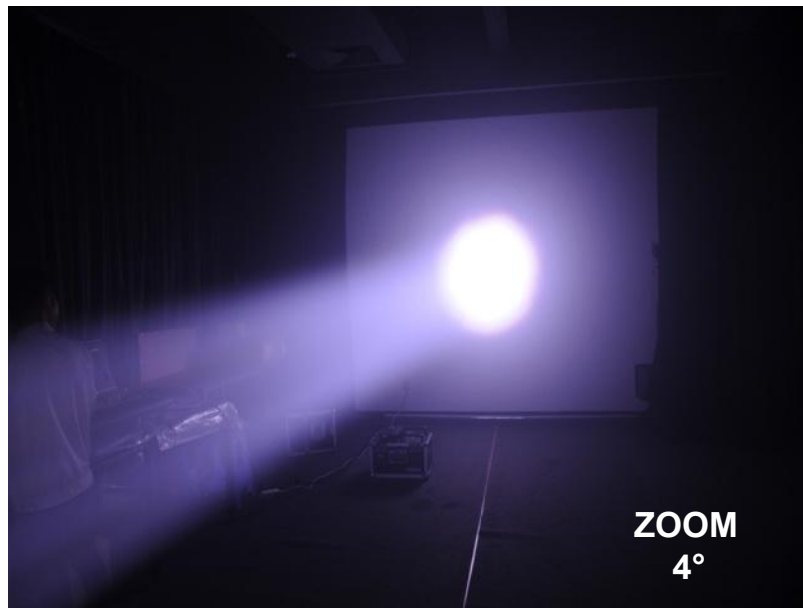

# 产品亮点

光斑清晰成像，单颗单色可控。

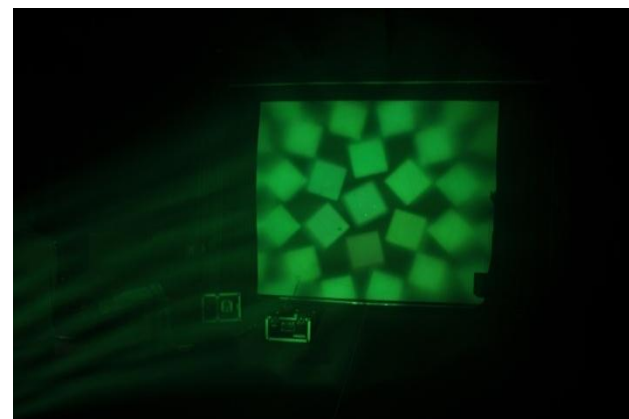
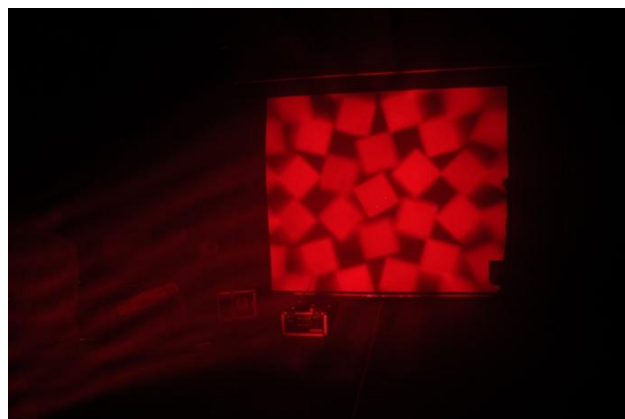
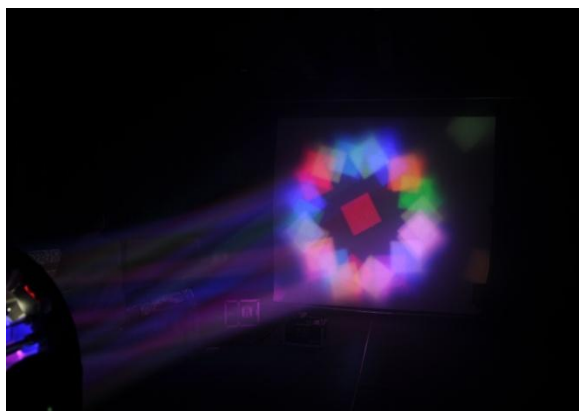
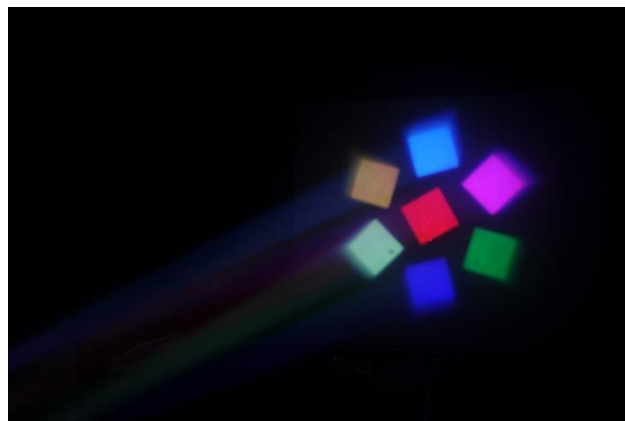



# 产品亮点

二次透镜无极旋转，创造出绚丽动感效果。

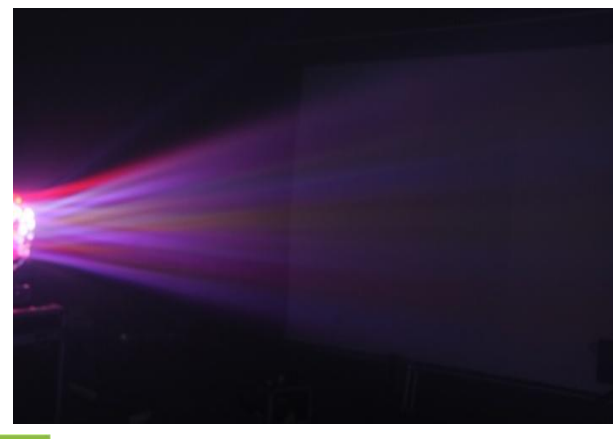
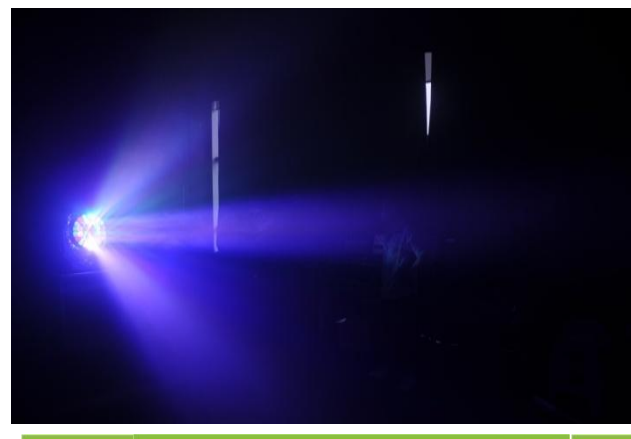
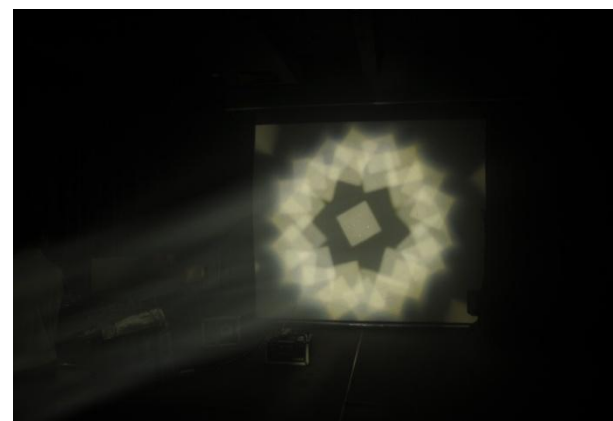
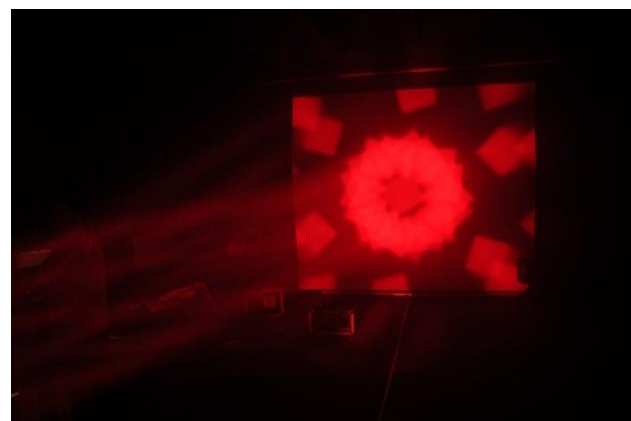
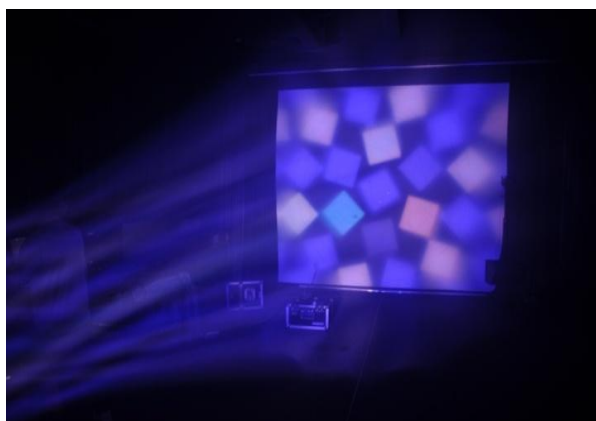

# 产品亮点

- 色温连续可调

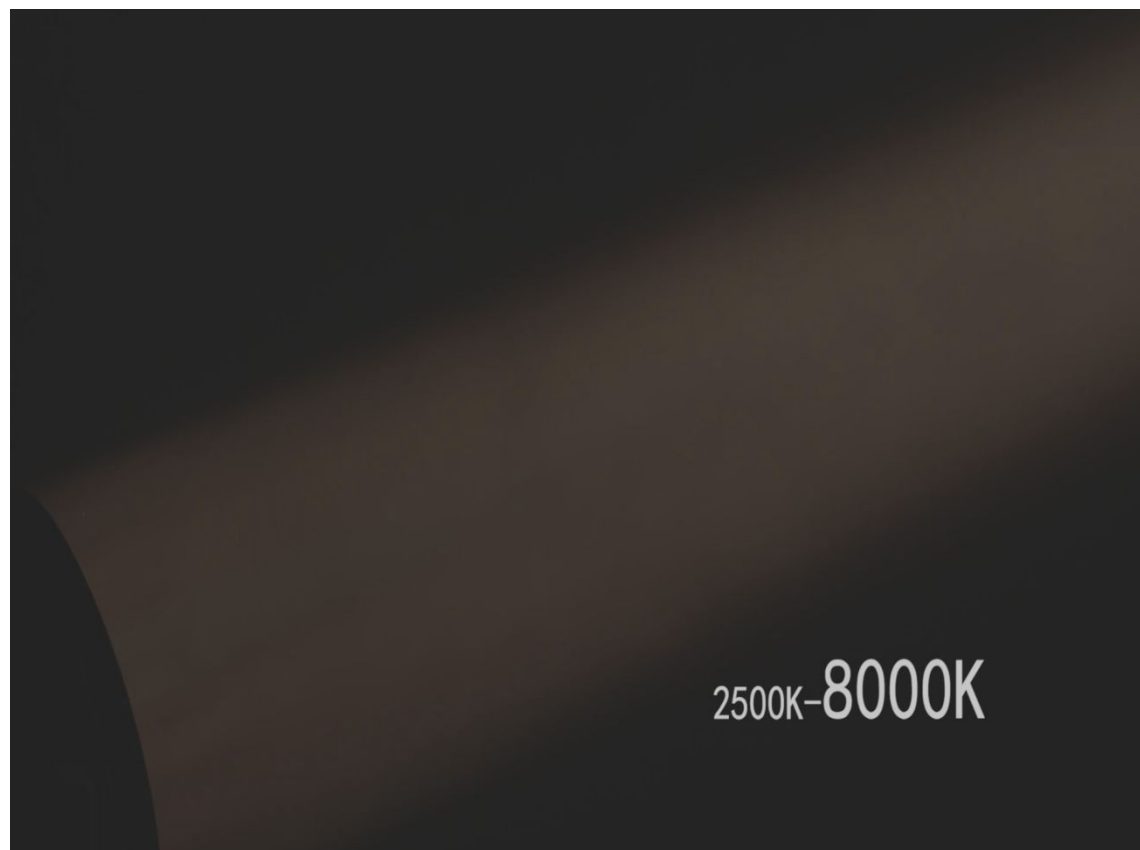

# 产品亮点

- 电子频闪

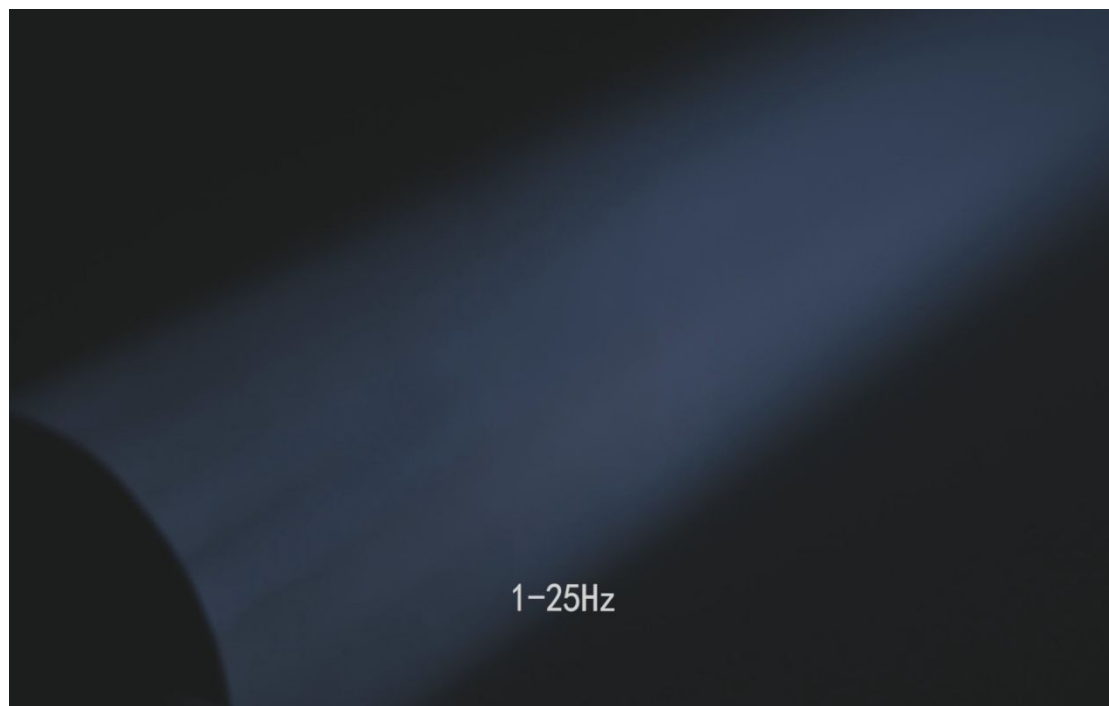

# 产品亮点

- 65536级电子调光

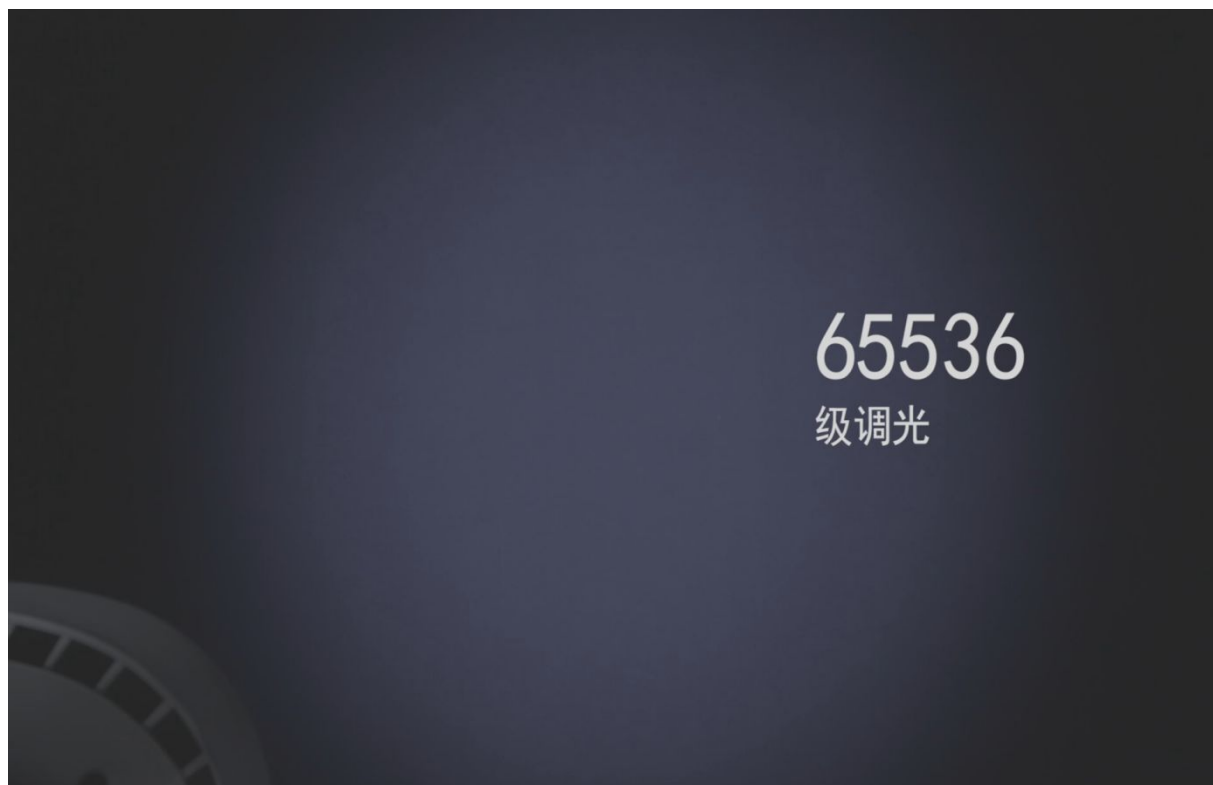

# 产品亮点

- 内置效果宏功能

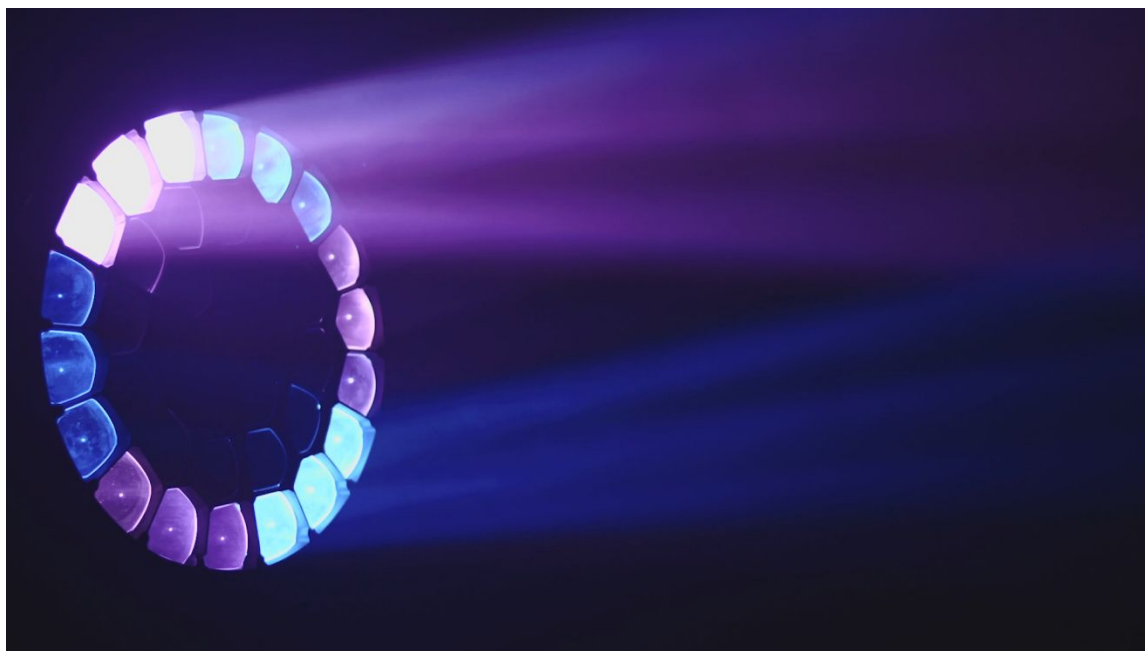

# FINE 850C STROBE

灯珠:6W×144颗 RGBW 四色 OSRAM灯珠

光斑角度:100°

光通量输出:15000lm

通道数量:2/7/8

通讯协议:DMX512

控制面板:LCD液晶屏+按键

防护等级:IP20



# FINE 850W STROBE

灯珠:6W×144颗白色 OSRAM 灯珠

光斑角度:100°

光通量输出:31500lm 瞬间50000lm

通道数量:2/7/8

通讯协议:DMX512

控制面板:LCD液晶屏+按键





产品优点：

1.采用德国研发和生产的数字电源；



## 2.丰富的频闪效果, 强力频闪



### 3.具有频闪、常亮和染色功能，既可当频闪灯，又可当染色灯；

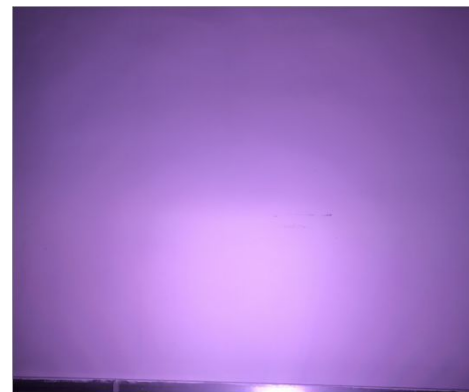
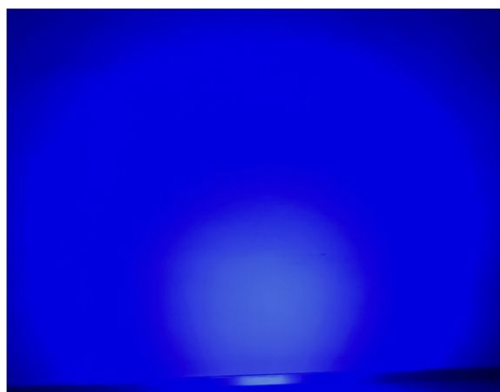

4.模拟传统光源条形分布,采用反光碗光学设计,保留传统频闪灯风格;LED隐藏,看不到直射光。

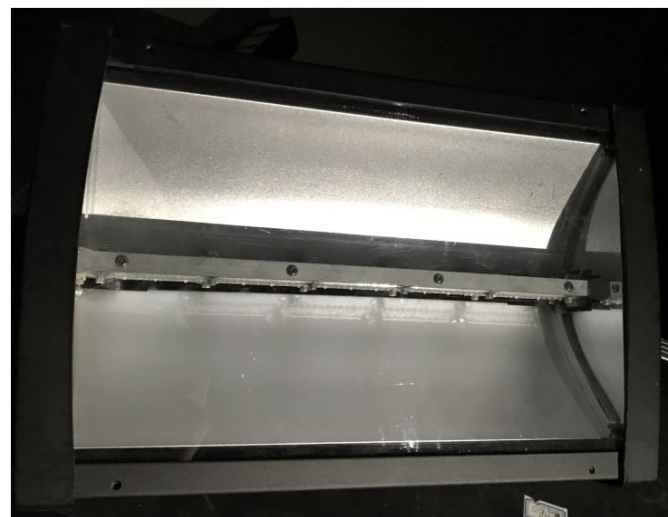
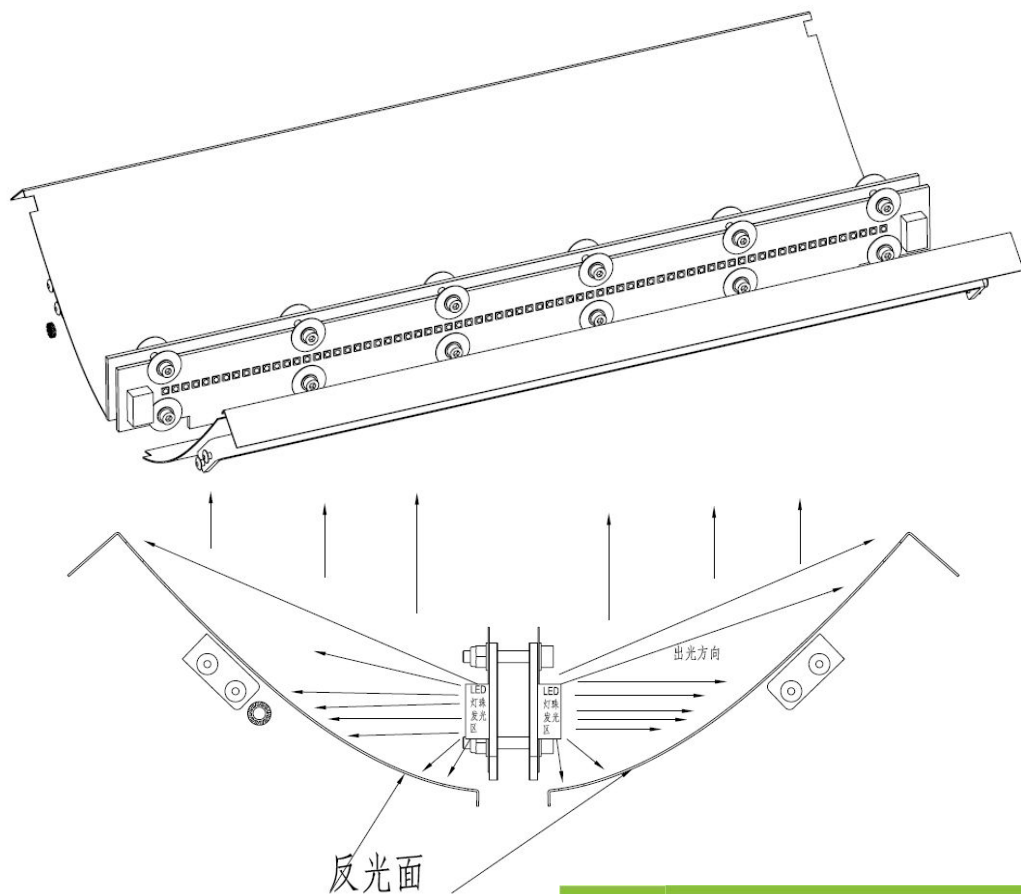

5.节能环保, 相同亮度不到传统光源的三分之一功耗;



炭排放减少了





# FINE 400CL

灯珠：PHILIPS LED光源128颗\*3W

角度：45 ° × 60 °

显色指数CRI：Ra>93，R9>93

通道数量：1/3/4

通讯协议：DMX512

控制面板：LED米字屏+按键

防护等级：IP20



适用于各大专业剧场剧院、  
展馆、演播室等场所

## 产品优点：

- 1.400W超大功率，光输出突破12500Lm；
- 2.采用Philips RGBL（薄荷）A（琥珀）五种颜色光源，实现更连续的光谱光学；
- 3.搭载先进HS I色彩管理系统，实现调色板与灯具输出色彩一一对应；
- 4.超静音设计<28db；
- 5.楔形非对称反光碗光学设计，光效更高，铺光和混光更均匀；
- 6.内置2700K~7000K线性可调色温，Ra>93；R9>93；



谢谢！

