

Составление технологической схемы производства ДСтП

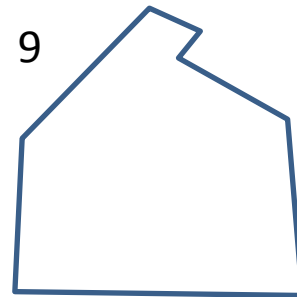

10

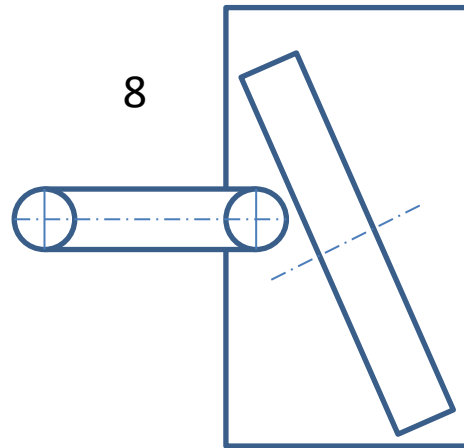
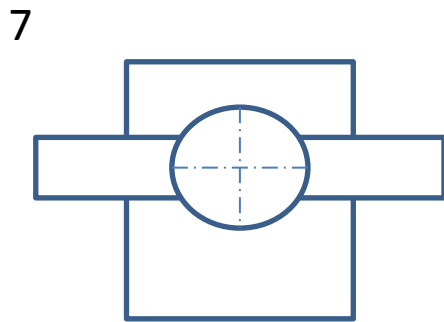
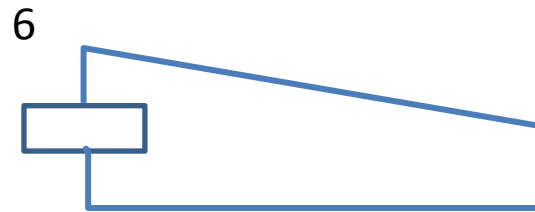
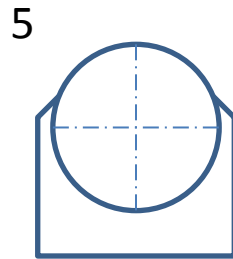
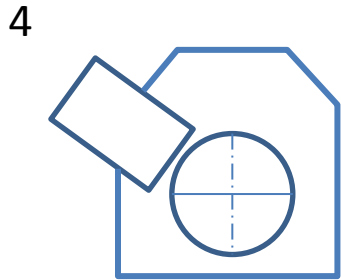
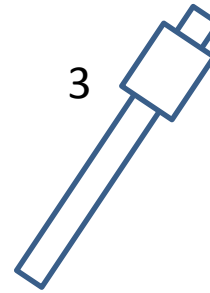
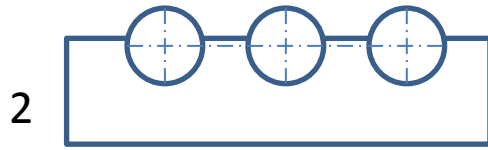
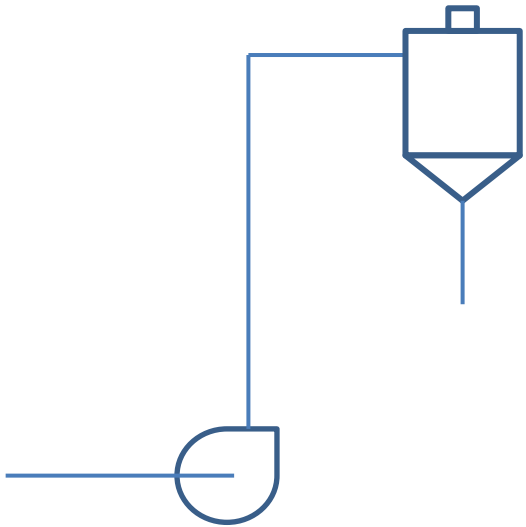

12

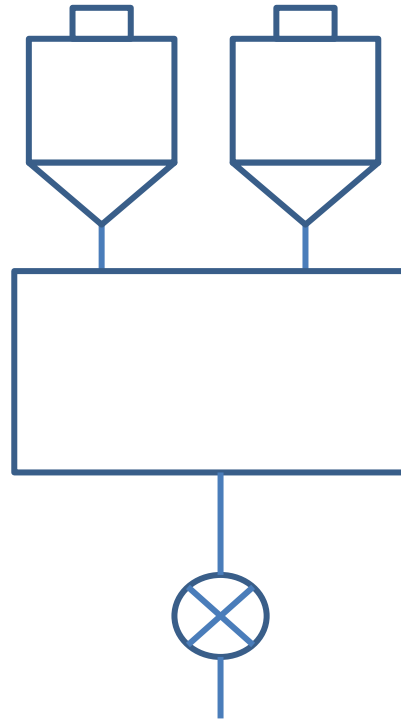

13

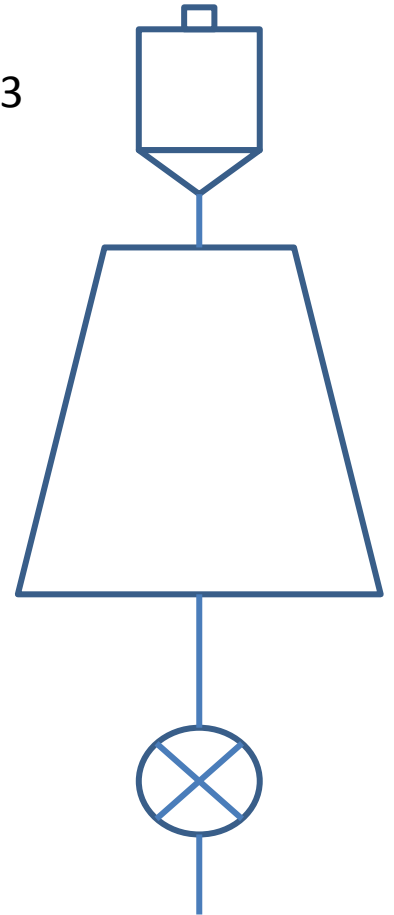

11

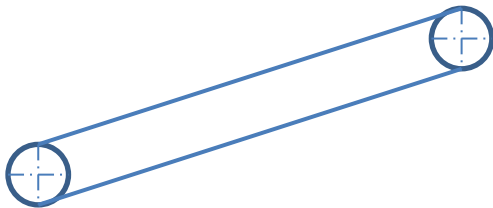

14 a

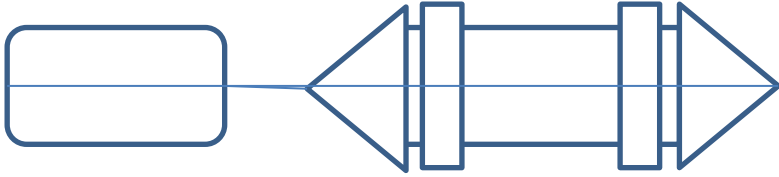

14 b

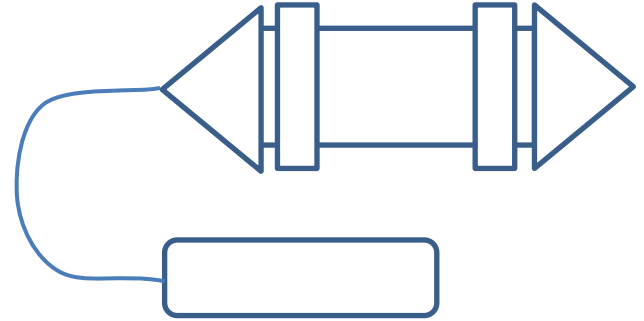

15

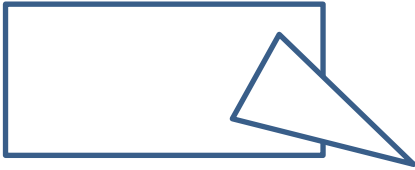

16

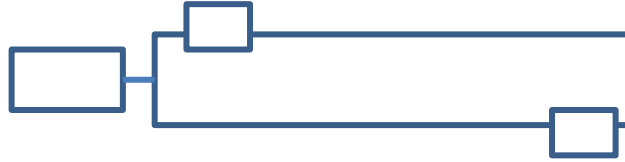

18



17

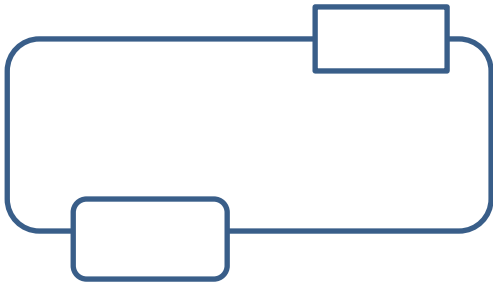

19



20



21 a

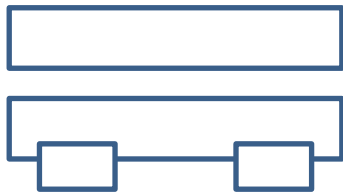

21 b

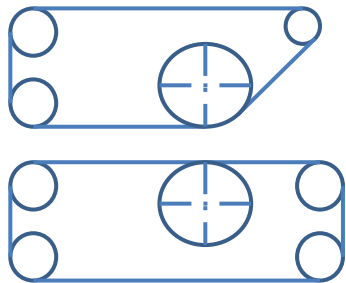

24

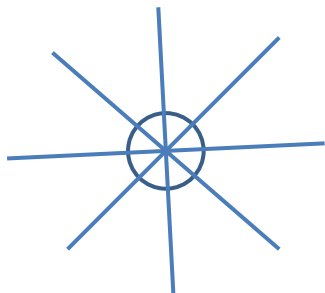

22

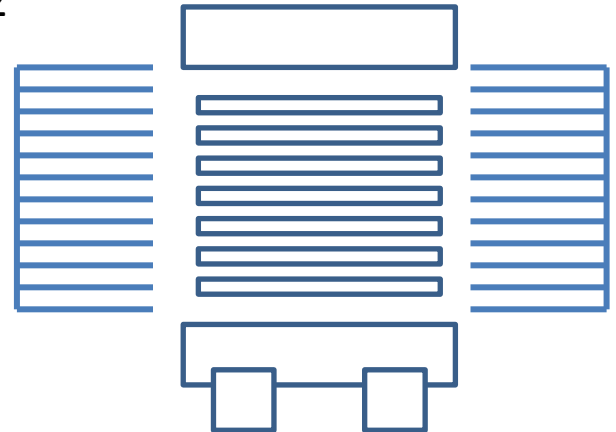

23



25

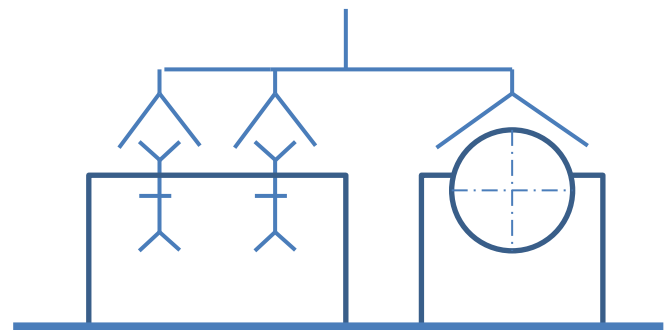

26

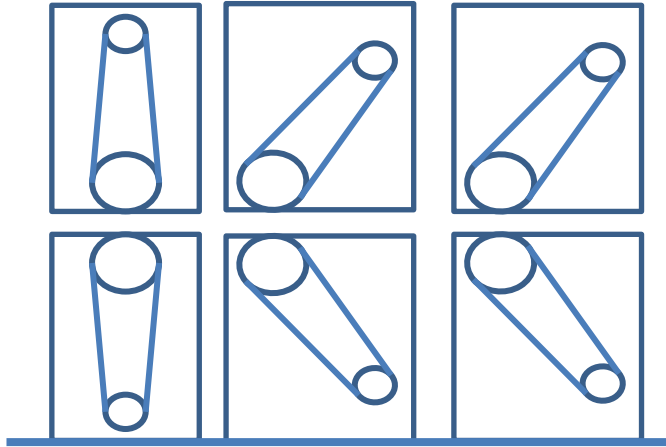

27

