

# Ребусы

Раздел: Кулинария



**Выполнила:**  
**Учитель технологии**  
**МОУ-СОШ № 4 г.Маркса**  
**Яркина Елена Борисовна**  
**2011**

# Ребусы

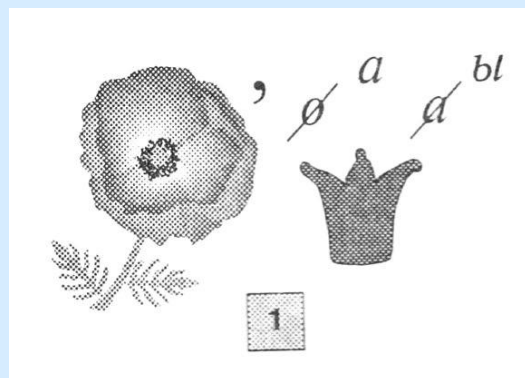

# Ребусы

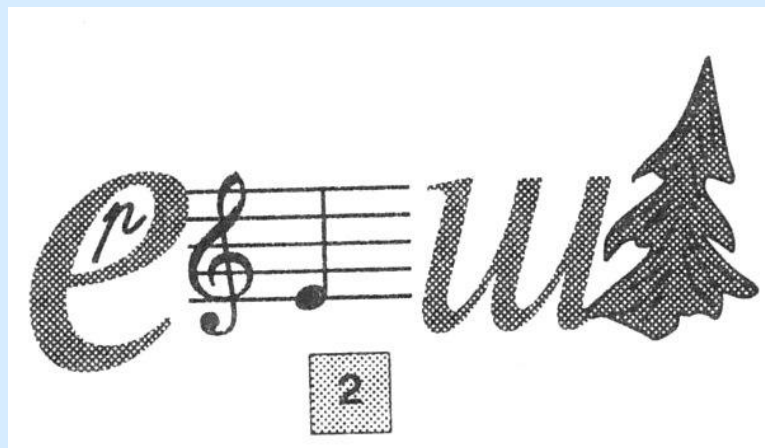

# Ребусы

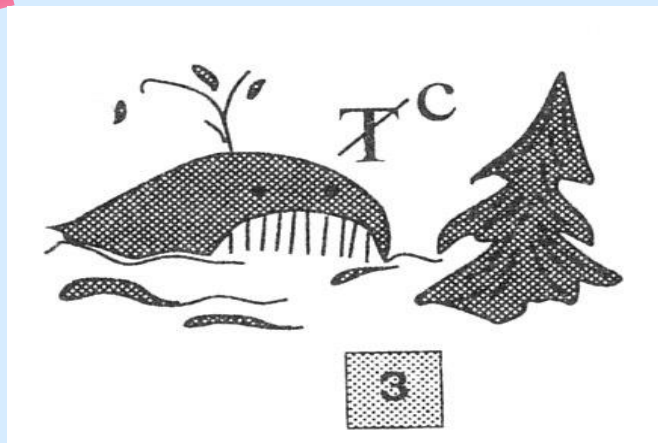

# Ребусы

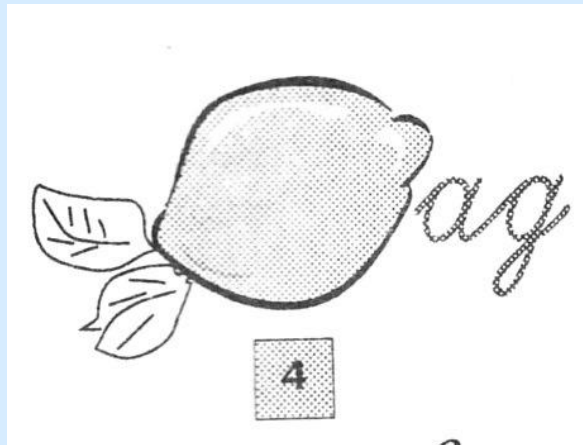

# Ребусы

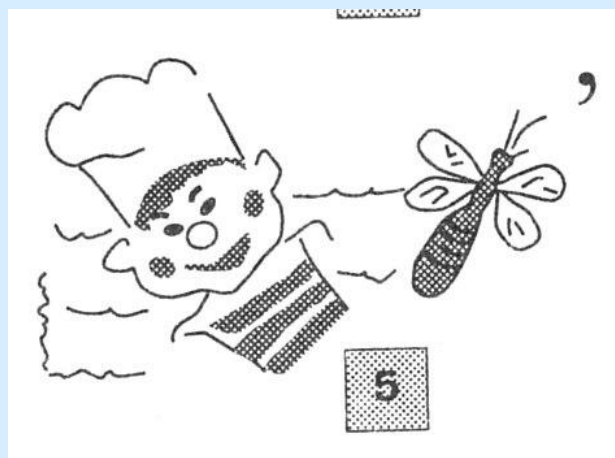

# Ребусы

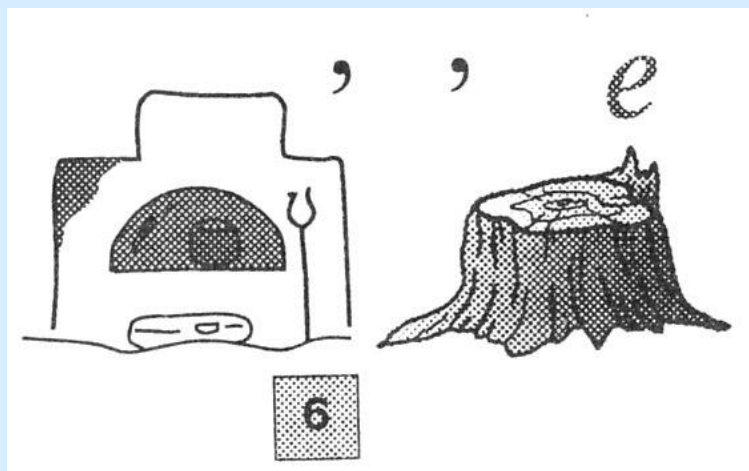

# Ребусы

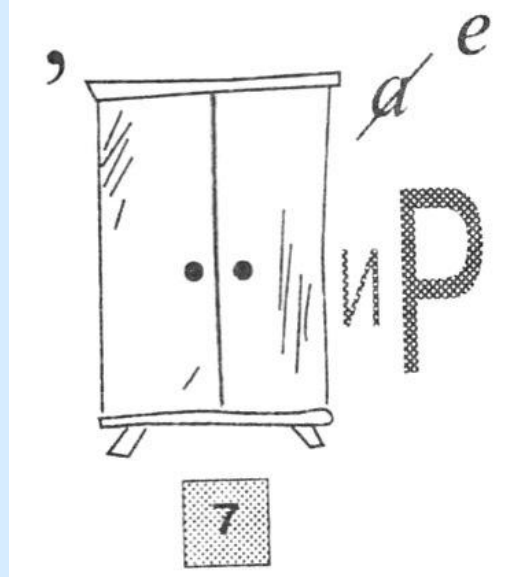



# Ребусы

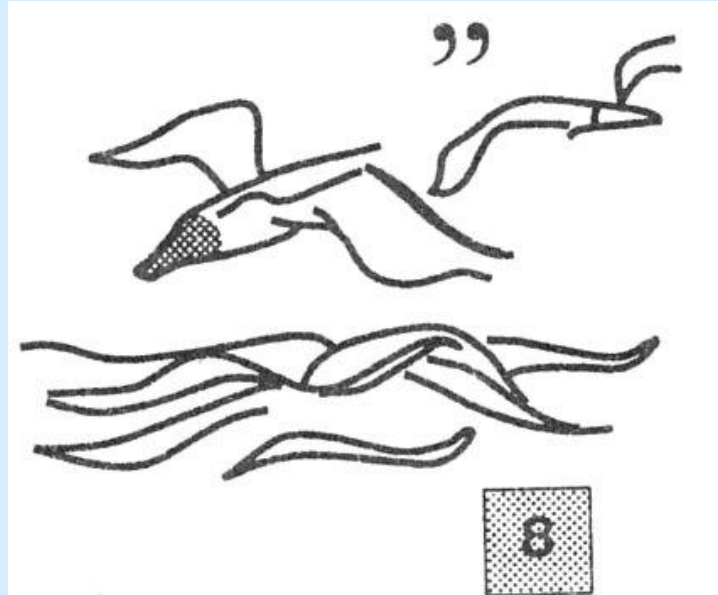

# Ребусы

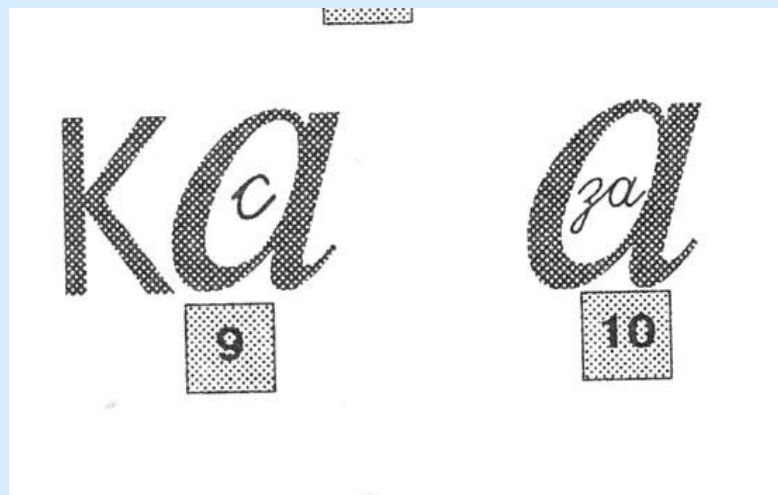

# Ребусы



11

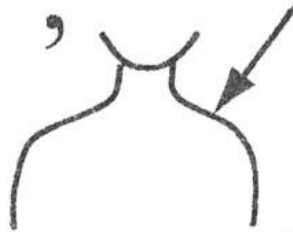

12



# Ребусы

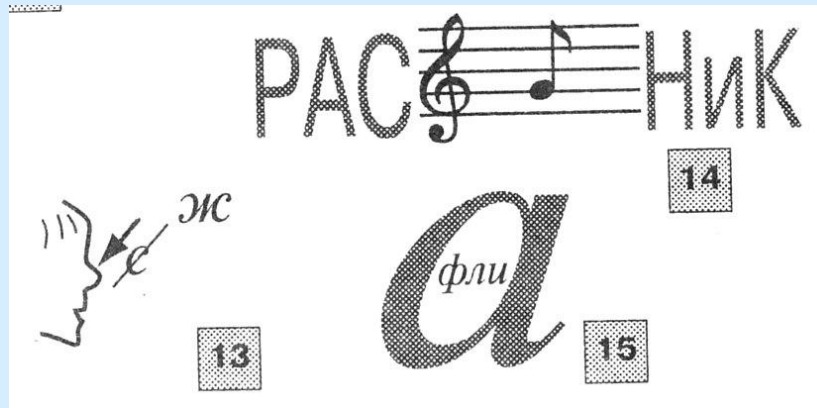

# Ребусы

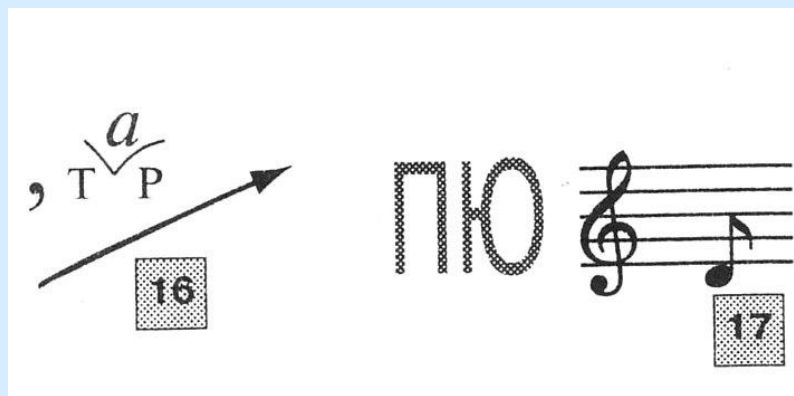

# Ребусы



# Ребусы

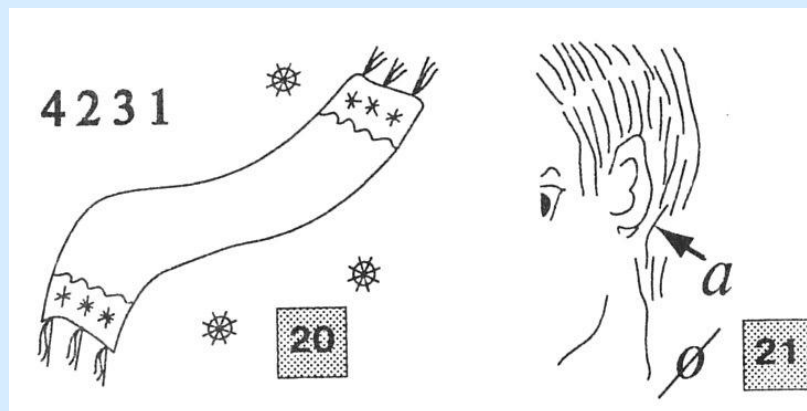

# Ребусы

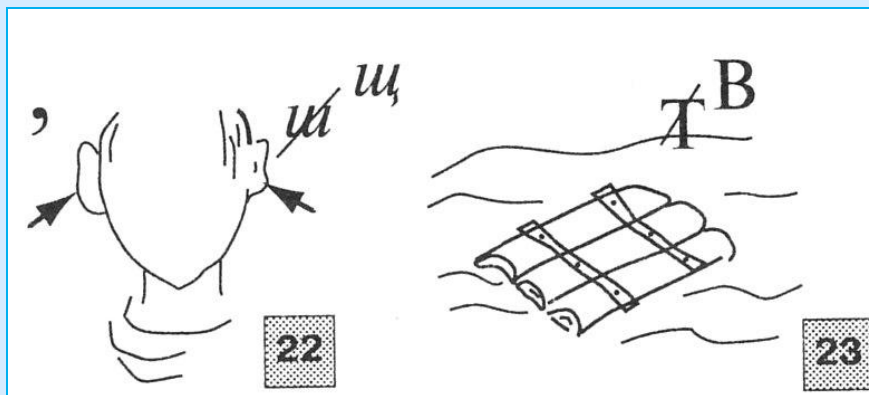



# Ребусы



24



25



# Ребусы

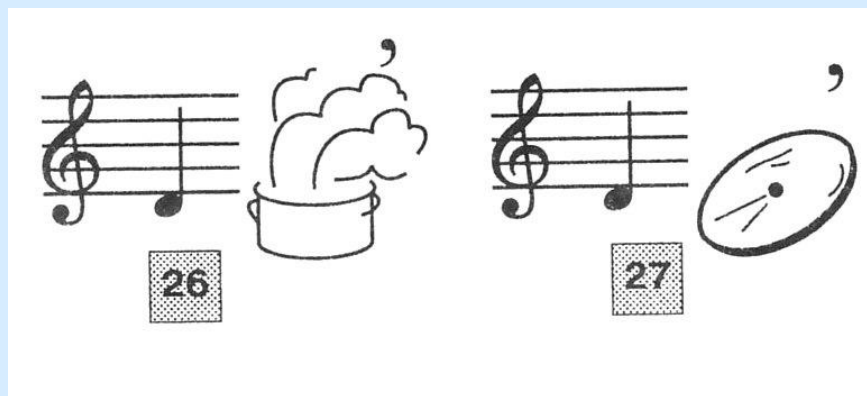

# Ребусы

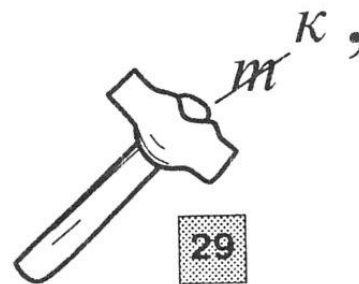
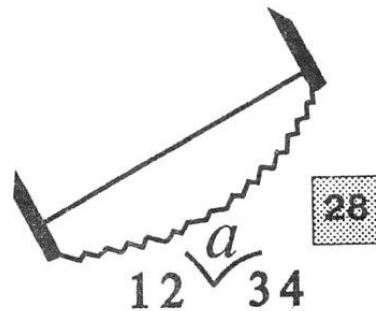

# Ребусы

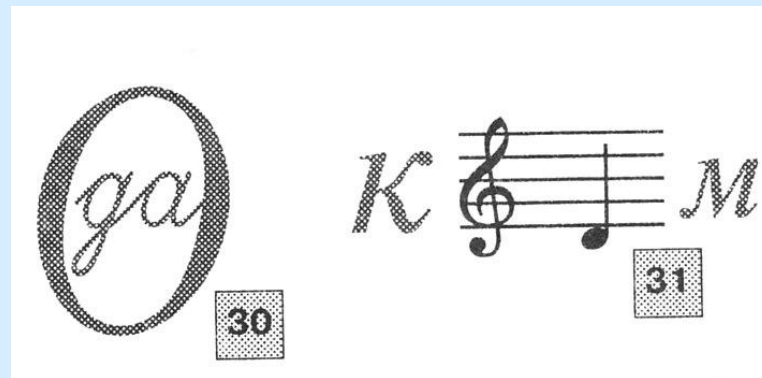

# Ребусы

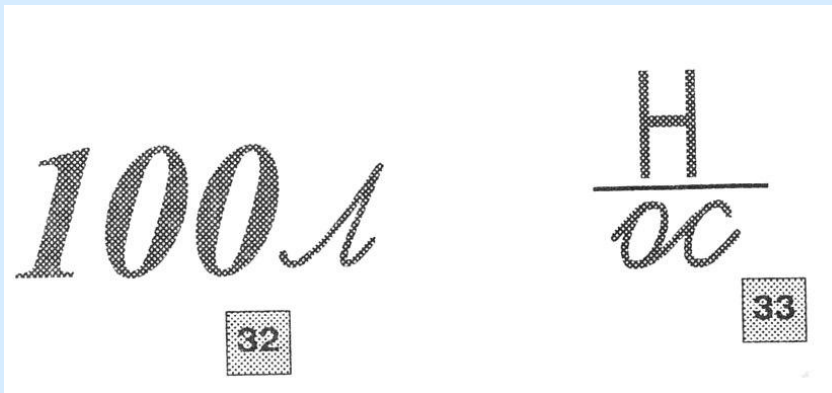

# Ребусы

$\frac{\text{БА}}{\text{Н}}$   
34

$\frac{\text{ММ}}{\text{ВА}}$   
35



# Ребусы



Удачи!  
Спасибо за участие!

Разработку презентации «Ребусы»  
выполнила  
Учитель технологии  
Яркина Елена Борисовна